



ORIGINAL INSTRUCTIONS



Instruction Manual Ionizer - Handheld type IZG10 Series

The intended use of this product is to neutralize charged objects.

1 Safety Instructions

These safety instructions are intended to prevent hazardous situations and/or equipment damage. These instructions indicate the level of potential hazard with the labels of "Caution", "Warning" or "Danger". They are all important notes for safety and must be followed in addition to International Standards (ISO/IEC)¹⁾, and other safety regulations.

- ¹⁾ ISO 4414: Pneumatic fluid power - General rules relating to systems.
ISO 4413: Hydraulic fluid power - General rules relating to systems.
IEC 60204-1: Safety of machinery - Electrical equipment of machines. (Part 1: General requirements)
ISO 10218-1: Manipulating industrial robots - Safety. etc.

- This manual contains essential information for the protection of users and others from possible injury and/or equipment damage. Refer to the product catalogue, Operation manual and Handling Precautions for SMC Products for additional information.
- Keep this manual in a safe place for future reference.

	Caution	Caution indicates a hazard with a low level of risk which, if not avoided, could result in minor or moderate injury.
	Warning	Warning indicates a hazard with a medium level of risk which, if not avoided, could result in death or serious injury.
	Danger	Danger indicates a hazard with a high level of risk which, if not avoided, will result in death or serious injury.

Warning

- Always ensure compliance with relevant safety laws and standards.
- All electrical work must be carried out in a safe manner by a qualified person in compliance with applicable national regulations.

2 Specifications

2.1 Ionizer Specifications

Model		IZG10
Ion generation method		Corona discharge
Method of applying voltage		High frequency AC type
Applied voltage		+/-2.5 kV
Offset voltage		Within +/-10 V
Air purge	Fluid	Air (Clean dry air)
	Operating pressure	0.05 to 0.6 MPa
	Tube O.D.	ø8 (mm), ø5/16" (inch)
Power supply voltage		24 VDC +/-10% (21.6 to 26.4 V)
Current consumption		90 mA (typ.)
Ambient temperature		0 to 40°C (No freezing)
Ambient humidity		35 to 65%RH (No condensation)
Material		Case: PBT Emitter: Tungsten
Weight (Body)	Standard nozzle	200 g
	Bypass nozzle	250 g

2 Specifications (continued)

2.2 AC adapter Specifications

Model	IZG10-CG*
Input voltage	100 to 240 VAC, 50/60 Hz
Output voltage	24 VDC +/-5%
Output current	0.8 A max
Ambient temperature	0 to 40°C
Ambient humidity	20 to 80% RH

3 Installation

3.1 Installation

Warning

- Do not install the product unless the safety instructions have been read and understood.

3.2 Handing

Warning

- Mount the designated nozzle to the product.
- Confirm that the nozzle is securely fitted before supplying compressed air. If the nozzle is loose, tighten it by hand until it does not rotate (recommended tightening torque: 0.1 to 0.2 N·m). Static neutralizing performance will deteriorate when the nozzle is loose.
- Be sure to wear safety goggles to protect the eyes from splashed substances.
- Do not direct the tip of the nozzle at the face or any other parts of the human body. It may cause injury.
- Do not use the product to clean or remove toxic substances or chemicals.
- Do not drop, step on or hit the product. Otherwise, the product may be damaged.
- If the product is to be used in a public place, ensure that it is not directed at people or used in a manner that could adversely affect the environment.
- This product is not a toy.
- After use be sure to hang the product on a hook, etc.
- Make sure that no twist, turn, tensile force or moment load is applied to the one-touch fitting, tube and power cable during use or storage. It may lead to damage or broken wires.
- Do not allow foreign matter to enter the ionizer nozzle.
The emitter is installed in the nozzle. If conductive objects such as metal tools or the human body either contacts or comes close to the emitter, reaction to electric shock can lead to further injuries due to collision with surrounding equipment. Also, if the tool damages the emitters, it may interfere with the specified function and performance, and may also cause operation failure or an accident.

Caution

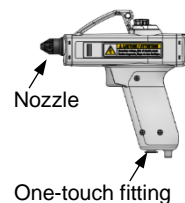

Caution: High Voltage

High voltage is applied to the emitters. Never touch the electrodes. Touching electrode may cause electrical shock and instantaneous rapid body motion to escape from the shock. Your body may then touch the equipment around you, causing injury.

- If a valve is placed immediately before the product, instantaneous air release may occur when compressed air is supplied regardless of the trigger operation of the product.
- If the air supply pressure is less than the product specification pressure (0.05 MPa), the valve in the product may not open or close. Use the product with a supply pressure within the product specification.

3.3 Environment

Warning

- Do not use in an environment where corrosive gases, chemicals, salt water or steam are present.
- Do not use in an explosive atmosphere.
- Do not expose to direct sunlight. Use a suitable protective cover.
- Do not install in a location subject to vibration or impact. Check the product specifications.
- Do not mount in a location exposed to radiant heat.

3 Installation (continued)

- Do not use this product in an enclosed space without ventilation.
This product utilizes the corona discharge phenomenon. A small amount of ozone and NOx will be generated. When the product is used in an enclosed space where ozone concentration is increased, the smell of ozone may be uncomfortable or aggressive. Even when the room is not an enclosed space, ozone concentration is increased when multiple products are used in a small space. The operating environment must always be ventilated.
- Take prevention measures against ozone.
Check that all surrounding equipment has ozone protection measures in place. Perform periodic checks of the product for deterioration caused by ozone.
- Supply compressed air when the product is in use.
Static neutralization is not possible without supplying compressed air. Without compressed air, the ozone or NOx generated by ion generation will stagnate and give adverse effects on the product or peripheral equipment.
- Keep within the specified ambient temperature range.
Ambient temperature range is 0 to 40°C. Do not use the product in locations where the ambient temperature changes suddenly even within the specifications or if the temperature difference of the fluid relative to the ambient temperature is large condensation may occur.
- Environments to avoid
Avoid using and storing this product in the following environments since they may cause damage to this product. These may cause an electric shock, fire, etc.
 - Areas where ambient temperature exceeds the operating temperature range.
 - Areas where ambient humidity exceeds the operating humidity range.
 - Areas where abrupt temperature changes may cause condensation.
 - Areas where corrosive gas, flammable gas or other volatile flammable substances are stored.
 - Areas where the product may be exposed to conductive powder such as iron powder or dust, oil mist, salt, organic solvent, machining chips, particles or cutting oil (including water and any liquids), etc.
 - Paths of direct air flow, such as air conditioners.
 - Enclosed or poorly ventilated environment.
 - Locations which are exposed to direct sunlight or heat radiation.
 - Areas where strong electromagnetic noise is generated, such as strong electrical and magnetic fields or supply voltage spikes.
 - Environment where static electricity is generated.
 - Locations where strong high frequency is generated.
 - Locations which are subject to potential lightning strikes.
 - In an area where the product may receive direct impact or vibration.
 - Areas where the product may be subjected to forces or weight that could cause physical deformation.
- Do not use air containing mist and/or dust.
This may cause performance deterioration and reduce the maintenance cycle.
Install a dryer (IDF series), air filter (AF/AFF series), and/or mist separator (AFM/AM series) to obtain clean compressed air (air quality of Class 2.4.3, 2.5.3, 2.6.3 or higher according to ISO 8573-1: 2010 (JIS B8392-1:2012) is recommended for operation).

- The product and AC adapter are not resistant to lightning surge.
- Influence on implantable medical equipment.
Electromagnetic waves emitted by this product may adversely affect implantable medical devices such as implantable cardiac pacemakers and implantable defibrillators. For precautions regarding the use of equipment or devices that may adversely affect performance, refer to the catalogue or instruction manual of the device or equipment, or contact the manufacturer directly.

3.4 Piping

Caution

- Before piping make sure to clean up chips, cutting oil, dust etc.
- When installing piping or fittings, ensure sealant material does not enter inside the port. When using seal tape, leave 1.5 to 2 threads exposed on the end of the pipe/fitting.
- Tighten fittings to the specified tightening torque.
- Flush the piping before connection to prevent particles, water drops, or oil content from entering the system.
- If a valve is placed immediately before the product, instantaneous air release may occur when compressed air is supplied regardless of the trigger operation of the product.

3 Installation (continued)

3.5 Wiring

- Before wiring, ensure that the power supply capacity meets the specification and that the voltage is within the specification. Product damage or malfunction can result.
- To maintain product performance, the power supply should be UL Class 2 certified by National Electric Code (NEC) or evaluated as a limited power source according to UL60950.
- The power supply must be disconnected before wiring (including insertion and removal of the connector). Otherwise, an electrical shock or accident may occur.
- To maintain the product performance, connect the product to ground with an earth cable or AC adapter ground terminal with a resistance of 100 Ω or less. If the product is not grounded, it is not possible to secure the performance and may lead to product failure or malfunction.
- If power and high voltage cables are routed together, the product may malfunction due to noise. Route the ionizer wires separately.
- Confirm that the wiring and piping are correct before supplying power and compressed air. Incorrect wiring and piping will lead to product damage or malfunction.

3.5.1 Wiring of AC adapter type

- Connect the M8 connector on the AC adapter power cable to the power connector on the main unit. Connect the AC cord outlet plug with the grounding terminal to a commercial power outlet with ground terminal (100 to 240 VAC 50/60 Hz).
- Connect the ground terminal correctly. The ground terminal is electrically connected to the frame ground (F.G.) of the product. The F.G. maintains the static neutralizing performance by keeping its potential the same as the reference potential.
- The input ground terminal and the output DC(-) terminal of the AC adapter (IZG10-CG1,2 ordered separately) are electrically connected. Do not connect any equipment other than this product. Otherwise, a failure or electric shock may result.

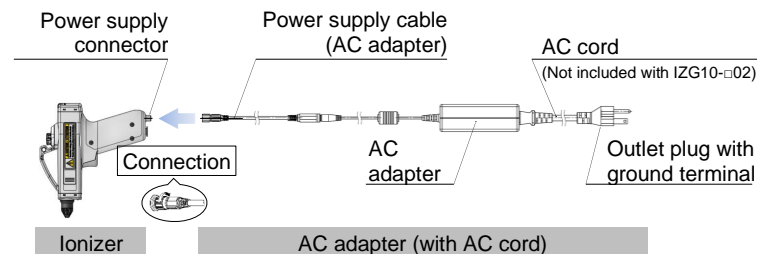

3.5.2 Wiring of power supply cable type

- Route external equipment for the power supply and external switch signal input prepared by the customer according to the signal name on the wiring table.
- Ground the green F.G. correctly. The static neutralizing performance is maintained by keeping its potential the same as the reference potential.

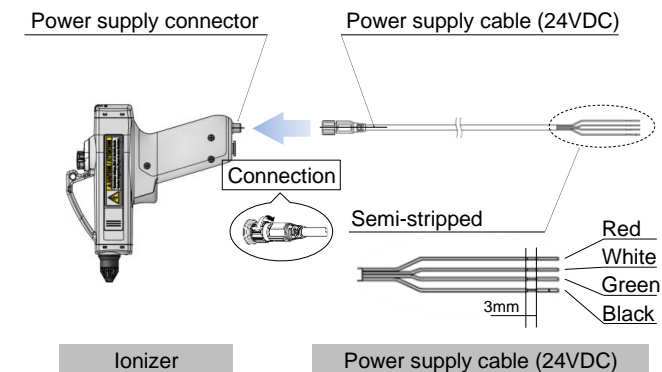

3 Installation (continued)

Internal Circuit and Wiring

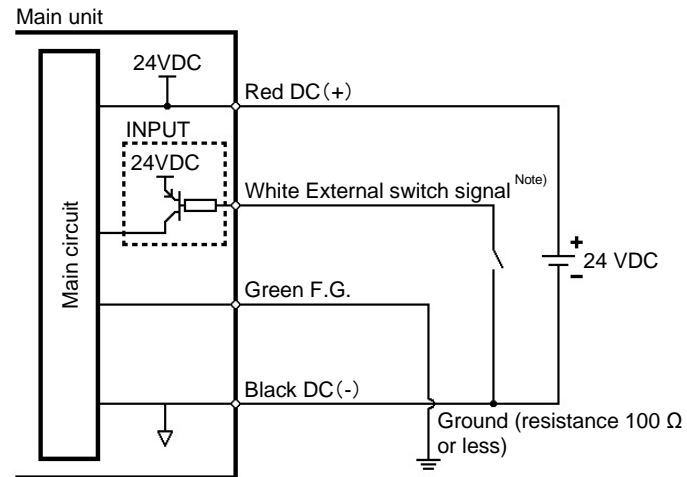

Note) When the external switch signal is not used, cut the semi-stripped wire to prevent the conductor from making contact.

Wire colour	Signal name	Description
Red	DC(+)	Connect the power supply(+) of the product
White	External switch signal	Blow starts by connecting with DC(-)
Green	F.G.	Frame ground of the product Ground resistance of 100 Ω or less
Black	DC(-)	Connect the power supply(-) of the product

4 Name and function of individual parts

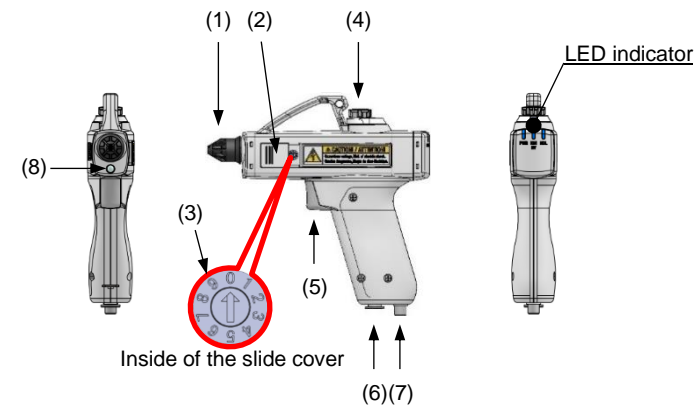

No.	Name	Description
(1)	Nozzle	Blows ionized air.
(2)	Slide cover	Protective cover for the mode setting switch.
(3)	Mode setting switch	Switch for setting blow and trigger. (Default setting: Setting No.0)
(4)	Flow rate adjustment handle	Adjust the flow by rotating the handle. Rotation is locked by pushing the handle.
(5)	Trigger	Switch to turn on and off static neutralization.
(6)	One-touch fitting	Compressed air supply port.
(7)	Power supply connector	Connector to input the signal for power supply, F.G. Ground and external switch.
(8)	Operation LED	LED is ON during static neutralization.

5 LED Indicator

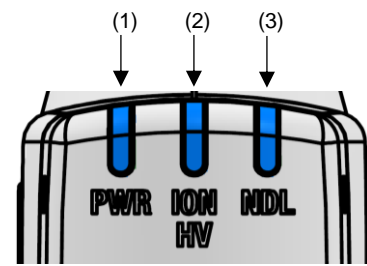

No.	LED	Colour	Name	Description
(1)	PWR	Green	Power supply indicator	Green LED turns ON when power is supplied, and the LED flashes when the voltage is outside of the specification range.
(2)	ION/HV	Green /Red	Ion emission/high voltage error indicator	Green LED is ON during static neutralization. Red LED is ON when a high voltage abnormality is present.
(3)	NDL	Green	Emitter maintenance indicator	Green LED is ON when the static neutralization performance is reduced due to contamination or wear of emitters.

6 Settings

6.1 Mode setting switch

- Blow or trigger can be selected by switching the mode setting switch.
 - Open the slide cover over the mode setting switch and rotate the dial to the setting number (No.0 to 9) while referring to the table below.
 - Be sure to close the slide cover after setting.
- Note) Default setting: Setting No.0

Setting No.	Blow setting	Trigger setting
0	Continuous blow	Trigger linked
1		Trigger locked
2		OFF timer 3 sec
3		5 sec
4	7 sec	
5	Pulse blow	Trigger linked
6		Trigger locked
7		OFF timer 3 sec
8		5 sec
9		7 sec

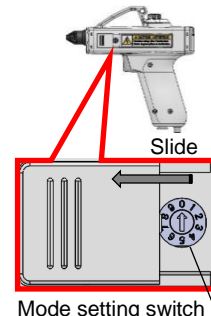

Blow setting

- Continuous blow (Set No.0 to No.4)
Blows ionized air continuously.
- Pulse blow (Set No.5 to No.9)
Blows ionized air intermittently.
Pulse frequency: 5 Hz

Trigger setting

Trigger ON is enabled by inputting either the main unit trigger or external switch signal.

- Trigger linked (Set No.0 and No.5)
Trigger ON/OFF and blow ON/OFF are linked.

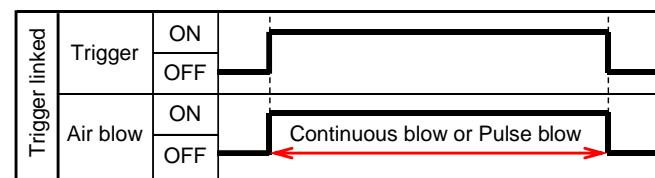

6 Settings (continued)

- Trigger locked (Set No.1 and No.6)
Blow ON is maintained when trigger operation is ON
When the trigger operation is ON again, the blow is OFF.

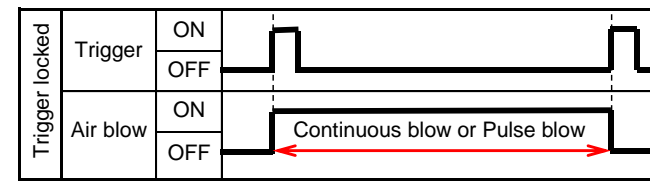

- OFF timer (Set No.2 to No.4, No.7 to No.9)
Blow ON is maintained when trigger operation is ON
Blow is automatically OFF after the set time has elapsed.
Timer set time: 3 sec, 5 sec, 7 sec

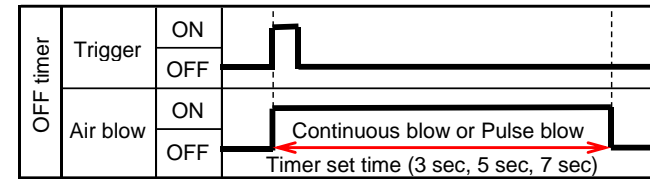

7 How to Order

Refer to the operation manual or catalogue on the SMC website (URL: <https://www.smcworld.com>) for "How to Order" information

8 Outline Dimensions (mm)

Refer to the operation manual or catalogue on the SMC website (URL: <https://www.smcworld.com>) for "Outline dimensions."

9 Maintenance

9.1 General Maintenance

- Not following proper maintenance procedures could cause the product to malfunction and lead to equipment damage.
- If handled improperly, compressed air can be dangerous. Maintenance of pneumatic systems should be performed only by qualified personnel.
- Before performing maintenance, turn off the power supply and be sure to cut off the supply pressure. Confirm that the air is released to atmosphere.
- After installation and maintenance, apply operating pressure and power to the equipment and perform appropriate functional and leakage tests to make sure the equipment is installed correctly.
- Do not make any modification to the product.
- Do not disassemble the product, unless required by installation or maintenance instructions.

9.2 Specific maintenance

- Perform maintenance regularly and clean the emitters.
Check regularly that the product is not operating with undetected failures. If the product is used for an extended period of time with foreign matter on the emitters, the static neutralizing performance of the product will be reduced. Clean the product regularly. (Emitter contamination level is different depending on the installation environment and supply pressure.) Clean the emitter and check the static neutralizing performance when the maintenance LED is on.
If the performance is not recovered after cleaning, it is possible that emitters are worn. Replace the emitter assembly.

Caution High Voltage

This product contains a high voltage generation circuit. When performing maintenance inspection, be sure to confirm that the power supply to the ionizer is turned off. Never disassemble or modify the product, as this can cause loss of product functionality, and there is also a risk of electric shock and earth leakage.

9 Maintenance (continued)

- Cleaning or replacing the emitters should never be performed while the power supply or compressed air supply are ON.
If the emitters are touched while the product is energized, this may cause an electric shock or accident.
- Mount the emitter correctly.
If emitters are not correctly mounted, they may eject or release when compressed air is supplied.
- Do not directly touch the emitters.
Do not touch the end of the emitters. They have a sharp end and touching them directly with your fingers may cause injury.
- Do not disassemble or modify the product.
Disassembling or modifying the product may cause product damage, electric shock or fire. The product will not be guaranteed if it is disassembled and/or modified.
- Do not operate the product with wet hands.
It may cause electric shock or other accidents.

Caution

- Please check the following points during regular maintenance, and replace parts as necessary.
 - Emitter is dirty or worn out
 - Loosening or damage of the nozzle
 - Squeezing or twisting of the connected tubing
 - Hardening or deterioration of the connected tubing
 - Air leakage

9.2.1 Emitter maintenance (cleaning and replacement)

If the product is used for an extended period of time with foreign matter on the emitters, the static neutralizing performance of the product will be reduced. Clean the emitters regularly. (Emitter contamination level is different depending on the installation environment and supply pressure.) This product is equipped with a function that monitors the amount of discharge from the emitter and turns on the maintenance indicator LED when the amount of discharge decreases. Clean the emitter and check the static neutralizing performance when the maintenance LED is on. If the performance is not recovered after cleaning of the emitters, it is possible that emitters are worn. Replace the emitter assembly. Clean the emitters with the cleaning kit [IZS30-M2] or a cotton bud soaked in alcohol. Cleaning and replacement of the emitters should never be performed while the product power and compressed air are supplied. If the emitters are touched while the product is energized, this may cause an electric shock or accident. Since the tip of the emitter is pointed, there is a danger of injury if touched. When replacing the emitter assembly, use a tool such as pliers to avoid direct contact with the tip of the emitter.

— Cleaning of the emitter —
Using the cleaning kit, saturate the felt with industrial alcohol, insert it into the emitters and rotate several times to clean. If the dirt does not come off, use the rubber grindstone to clean the emitters in the same way. After that, again use the felt saturated with industrial alcohol to finish the cleaning. If a cleaning kit is not available, saturate a cotton swab with alcohol (Note) to clean the emitters. Note) The industrial alcohol used should be reagent ethanol class 1 99.5 vol% or greater.

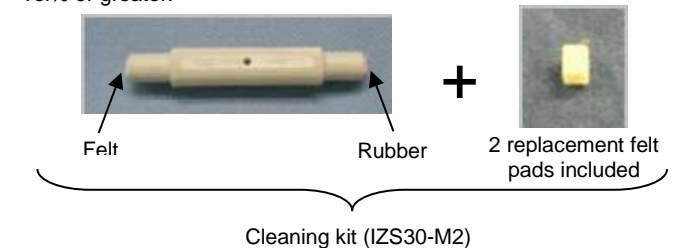

The cleaning kit has a felt pad and a rubber grindstone. Choose the felt pad or rubber grindstone depending on the level of contamination to effectively clean the emitters. The felt and rubber grindstone can be replaced.

9 Maintenance (continued)

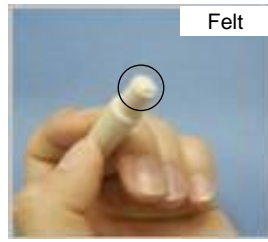

Felt

Use for normal cleaning



Rubber grindstone

Use if dirt cannot be removed with felt.

— Removing the nozzle and emitter assembly —

- 1) Be sure to stop the power supply and compressed air supply to the product.
- 2) Remove the nozzle by turning it by hand in direction shown below.
- 3) Set the removal tool to the emitter assembly, then rotate 90 degrees counter-clockwise. Hold the emitter assembly and withdraw the emitter assembly towards the front.

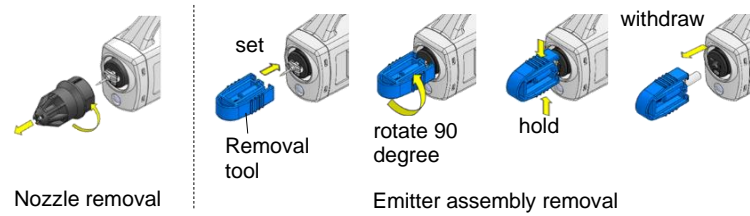

Nozzle removal

Emitter assembly removal

— Mounting the nozzle and emitter assembly —

- 1) Mount the replacement emitter assembly by rotating it as shown in the figure below with the protective cap attached.
- 2) Always remove the protective cap after mounting the emitter assembly. (Be careful when removing the cap, as there is a danger of injury due to the emitter tip).
- 3) Hand-tighten the nozzle in the direction shown below until it does not turn any more. (The recommended tightening torque by hand tightening is 0.1 to 0.2 Nm).
Static neutralizing performance is deteriorated when the nozzle is loose.

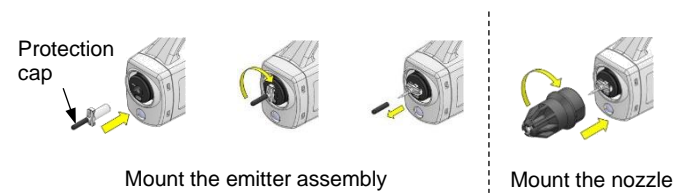

Mount the emitter assembly

Mount the nozzle

10 Limitations of Use

10.1 Limited warranty and Disclaimer/Compliance Requirements

Refer to Handling Precautions for SMC Products.

11 Product disposal

- This product should not be disposed of as municipal waste. Check your local regulations and guidelines to dispose of this product correctly, in order to reduce the impact on human health and the environment.

12 Contacts

Refer to www.smcworld.com or www.smc.eu for your local distributor / importer.

SMC Corporation

URL : <http://www.smcworld.com> (Global) <http://www.smc.eu> (Europe)
 SMC Corporation, 4-14-1, Sotokanda, Chiyoda-ku, Tokyo 101-0021, Japan
 Specifications are subject to change without prior notice from the manufacturer.
 © 2021 SMC Corporation All Rights Reserved.
 Template DKP50047-F-085M