

Rotary Cylinder

MRQ Series

Size: 32, 40

A rectilinear rotation unit that compactly integrates a slim cylinder and a rotary actuator.

The timing of the rectilinear and rotational movements can be set as desired.

Rotational movements are possible at the forward end, the back end, or during a rectilinear movement.

Effective output

(At 0.5 MPa)

Size 32 = 1 N·m

Size 40 = 1.9 N·m

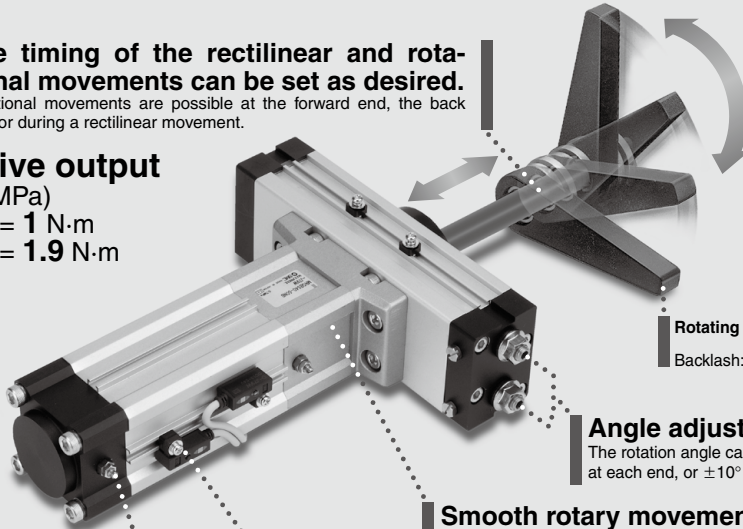

Rotating angle: 80 to 100°
170 to 190°
Backlash: Within 2°

Angle adjustable

The rotation angle can be adjusted $\pm 5^\circ$ at each end, or $\pm 10^\circ$ at both ends.

Smooth rotary movement

Roller bearings are used in the rotating portion.

Equipped with an auto switch

(Mountable on both sides)

Magnet included as standard.

(Reed auto switch: D-A7/A8)

(Solid state auto switch: D-F7/J7)



An air cushion is also available.

MRQ Series

Size of linear motion parts	Output of rotary motion parts (at 0.5 MPa)	Rotating angle	Linear motion stroke (mm)																	
			5	10	15	20	25	30	40	50	75	100								
32	1.02 N·m	80 to 100°	●	●	●	●	●	●	●	●	●	●	●	●	●	●	●	●	●	●
		170 to 190°	●	●	●	●	●	●	●	●	●	●	●	●	●	●	●	●	●	●
40	1.91 N·m	80 to 100°	●	●	●	●	●	●	●	●	●	●	●	●	●	●	●	●	●	●
		170 to 190°	●	●	●	●	●	●	●	●	●	●	●	●	●	●	●	●	●	●

Application Example

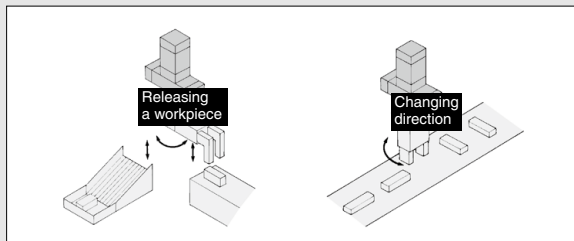

A connecting port can be selected from two positions that are available on the rotation unit.

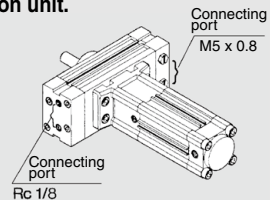

Connecting ports are provided "IN" two positions as standard specifications.

Technical Data 1: How to Set Rotation Time

Allowable Kinetic Energy

If the product is used in a state in which its kinetic energy exceeds the allowable value, it could cause damage inside the product, which could cause the product to go out of the order. The bounce phenomenon may also occur at the rotating ends; thus, make sure that the kinetic energy does not exceed the allowable value during design and operation.

(A chart that depicts the moments of inertia and the rotation time is provided to facilitate the selection process.)

1. Setting of rotation time

Set the rotation time within the adjustable rotation time range that ensures stable operation, based on the table on the right.

Setting the speed higher than the upper limit could cause the actuator to stick or slip.

Size	Allowable kinetic energy (J)	Adjustable rotation time range that ensures stable operation (s/90°)
32	0.023	0.2 to 1
40	0.028	0.2 to 1

2. Calculating of the moment of inertia

Formula of moment of inertia is subject to load shape. Refer to the moment of inertia formula on pages 34 to 39.

3. Selecting of a model

Select models by applying the moment of inertia and rotation time which have been found to the charts below.

Moment of Inertia and Rotation Time

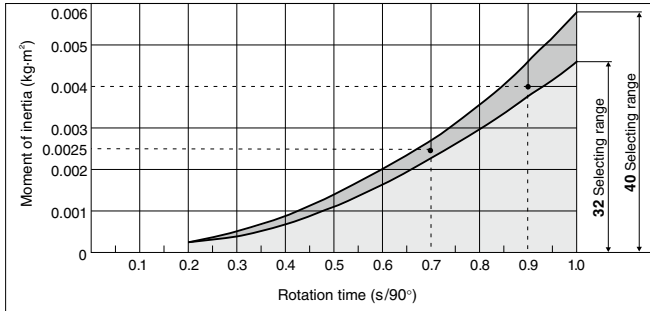

<How to read the graph>

- Moment of inertia.....0.0025 kg·m² • Rotation time.....0.7 s/90°, size 40 will be selected.

<Calculation example>

Load shape: Column with a radius of 0.2 m and a weight of 0.2 kg
Rotation time: 0.9 s/90°

$$I = 0.2 \times \frac{0.2^2}{2} = 0.004 \text{ kg}\cdot\text{m}^2$$

In the chart that depicts the moment of inertia and the rotation time, find the intersecting point of the lines that extend from the locations corresponding to 0.004 kg·m² on the vertical axis (moment of inertia) and to 0.9 s/90° on the horizontal axis (rotation time). Select size 40 because the intersecting point is found within the selection range for size 40.

How to Calculate the Load Energy

$$E = \frac{1}{2} \cdot I \cdot \omega^2, \quad \omega = \frac{2\theta}{t}$$

E : Kinetic energy.....(J)

I : Moment of inertia.....(kg·m²)

ω^* : Angular velocity.....(rad/s)

θ : Rotation angle.....(rad)

180° = 3.14 rad

t : Rotation time.....(s)

* The ω that is obtained here is the terminal angular velocity of an isometric acceleration movement.

Technical Data 2: Theoretical Output

4. Linear motion parts theoretical output

(N)

Size	Rod diameter (mm)	Operating direction	Piston area (mm ²)	Operating pressure (MPa)						
				0.15	0.2	0.3	0.4	0.5	0.6	0.7
32	12.2	OUT	804	121	161	241	322	402	482	563
		IN	675	101	135	202	270	337	405	472
40	14.2	OUT	1256	183	251	377	502	628	754	879
		IN	1081	162	216	324	433	541	649	757

(Formula) Thrust (N) = Piston area (mm²) x Operating pressure (MPa)

Output from the Linear Motion Part

Formula

$F_1 = \gamma \times A_1 \times P$	(1)
$F_2 = \gamma \times A_2 \times P$	(2)
$A_1 = \frac{\pi}{4} D^2$	(3)
$A_2 = \frac{\pi}{4} (D^2 - d^2)$	(4)

F_1 = Cylinder force generated on the extending side (N)

F_2 = Cylinder force generated on the retracting side (N)

γ = Load rate

A_1 = Piston area on the extending side (mm²)

A_2 = Piston area on the retracting side (mm²)

D = Tube bore size (mm)

d = Piston rod diameter (mm)

P = Operating pressure (MPa)

Note) As shown in the diagram below, the retracting side pressure surface area of the double acting single rod cylinder is reduced by the area that corresponds to the piston rod's cross sectional area.

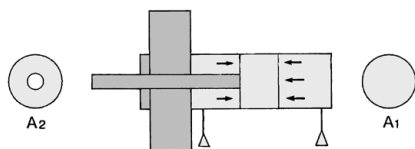

Load rate γ

In the process of selecting an appropriate cylinder, remember that there are sources of resistance other than the load that apply in the output direction. Even at a standstill as shown in the diagram below, the resistance that is incurred by the seals or bearings in the cylinder must be subtracted. Furthermore, during operation, the reactive force that is created by the exhaust pressure also acts as resistance.

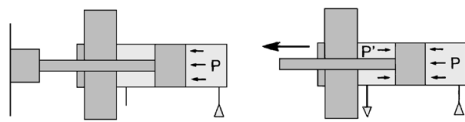

While not operated

While operated

Because resistance that counters the cylinder output vary with conditions such as the cylinder size, pressure, and speed, it is necessary to select an air cylinder of a greater capacity. For this purpose, the load ratio is used; make sure that the load ratio values listed below are obtained when selecting an air cylinder.

- 1) Using the cylinder for stationary operation: load ratio $\gamma = 0.7$ (Fig. 1)
- 2) Using the cylinder for dynamic operation: load ratio $\gamma = 0.5$ (Fig. 2)
- 3) Using a guide type for horizontal operation: load ratio $\gamma = 1$ (Fig. 3)

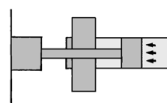

Fig. 1 $\eta = 0.7$ or more

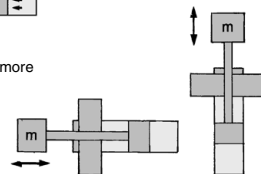

Fig. 2 $\eta = 0.5$ or less

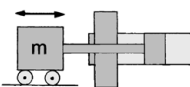
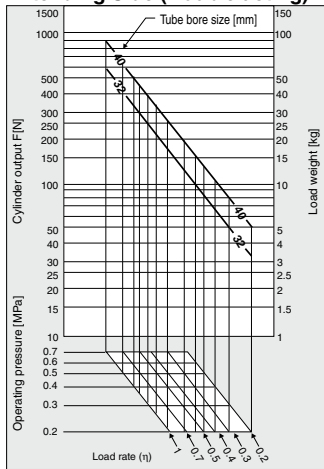

Fig. 3 $\eta = 1$ or more

Note) For dynamic operation, the load ratio may be set even lower if it is particularly necessary to operate the cylinder at high speeds. Setting it lower provides a greater margin in the cylinder output, thus enabling the cylinder to accelerate more quickly.

Technical Data 3: Theoretical Output/Side Load/Allowable Moment

Graph (1) Cylinder Output on the Extending Side (Double acting)



Graph (2) Cylinder Output on the Retracting Side (Double acting)

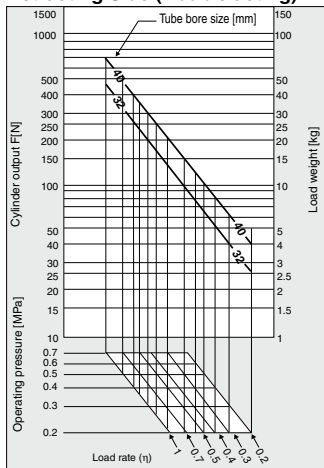

How to read the graph

1. Decide on the direction in which the cylinder output will be used (the extension or the retraction side). (See graph (1) for the extension side, and graph (2) for the retraction side.)
2. Find the point at which the load ratio (diagonal line) and the operating pressure (horizontal line) intersect. Then, extend a vertical line from that point. (Determine the load ratio η in accordance with the load ratio η that has been determined on page 421.)
3. Extend a horizontal line from the necessary cylinder output (left diagram), and find the point at which it intersects with the vertical line of 2. The diagonal line above that intersecting point represents the inner diameter of the tube that can be used.

5. Rotary motion theoretical output

(N·m)

Size	Operating pressure (MPa)						
	0.15	0.3	0.3	0.4	0.5	0.6	0.7
32	0.34	0.45	0.68	0.90	1.13	1.36	1.58
40	0.64	0.85	1.27	1.70	2.12	2.54	2.97

Graph of Effective Output

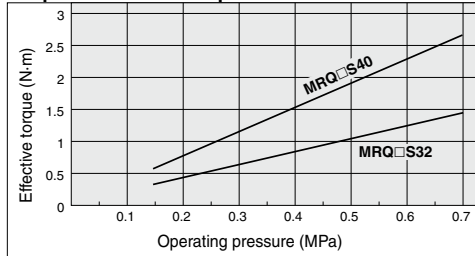

6. The allowable lateral load and the moment at the tip of the piston rod

An excessive amount of lateral load or moment applied to the piston rod could cause a malfunction or internal damage. The allowable load range varies by conditions such as the installed orientation of the cylinder body or whether an arm lever is attached to the tip of the piston rod. Find the allowable value from the diagram shown below and operate the rotary cylinder within that value.

1) Using the cylinder body installed horizontally:

To operate the rotary cylinder with the cylinder body installed horizontally, make sure that the total load that is applied to the tip of the piston rod will be within the value indicated in the table below. If the center of gravity of the total load is not in the center of the shaft, provide a balance weight as illustrated below so that moment in the rotational direction would not be applied to the tip of the piston rod.

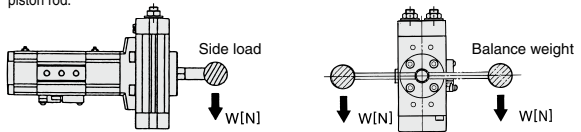

Allowable Side Load on the Piston End

(N·m)

Size	Stroke of linear part									
	5	10	15	20	25	30	40	50	75	100
32	14	14	13	13	13	12	12	11	10	9
40	23	23	22	21	21	20	19	18	16	15

2) Using the cylinder body installed vertically:

To operate the rotary cylinder with the cylinder body installed vertically, the total load that is applied to the tip of the piston rod must be within the thrust of the rectilinear portion in which the load ratio is taken into consideration. (Refer to page 421 for further information on load rate.)

If the center of gravity of the total load is not in the center of the shaft, it is necessary to calculate the moment. Make sure that the moment is within the value shown in the table below.

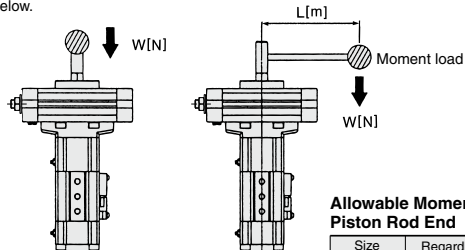

Allowable Moment on the Piston Rod End

Size	Regardless of the stroke
32	2.1 [N · m]
40	3.8 [N · m]

Affecting moment to the piston rod end
Moment = $W \times L$ [N·m]

Technical Data 4: Air Consumption

7. Air consumption

Air consumption is the volume of air which is expended by the rotary actuator's reciprocal operation inside the actuator and in the piping between the actuator and the switching valve, etc. This is necessary for selection of a compressor and for calculation of its running cost. Results are determined by measuring the factors through 1 complete cycle over one minute.

Rotary Motion Parts Angle of rotation: 90°, 180° (L (ANR))

Size	Rotation angle	Volume (cm ³)	Operating pressure (MPa)						
			0.15	0.2	0.3	0.4	0.5	0.6	0.7
32	80 to 100°	4.88	0.024	0.029	0.039	0.049	0.059	0.068	0.078
	170 to 190°	8.46	0.042	0.051	0.068	0.085	0.102	0.118	0.135
40	80 to 100°	9.22	0.046	0.055	0.074	0.092	0.111	0.129	0.148
	170 to 190°	15.9	0.080	0.095	0.127	0.159	0.191	0.223	0.254

Linear Motion Parts (L (ANR))

Size	Stroke (mm)	Internal volume (cm ³)		Operating pressure (MPa)						
		Head side	Rod side	0.15	0.2	0.3	0.4	0.5	0.6	0.7
32	5	4.0	3.4	0.019	0.022	0.030	0.037	0.044	0.052	0.059
	10	8.0	6.7	0.037	0.044	0.059	0.074	0.088	0.103	0.118
	15	12.1	10.1	0.056	0.067	0.089	0.111	0.133	0.155	0.178
	20	16.1	13.5	0.074	0.089	0.118	0.148	0.178	0.207	0.237
	25	20.1	16.9	0.093	0.111	0.148	0.185	0.222	0.259	0.296
	30	24.1	20.2	0.111	0.133	0.177	0.222	0.266	0.310	0.354
	40	32.2	27.0	0.148	0.178	0.237	0.296	0.355	0.414	0.474
	50	40.2	33.7	0.185	0.222	0.296	0.370	0.443	0.517	0.591
	75	60.3	50.6	0.277	0.333	0.444	0.555	0.665	0.776	0.887
40	100	80.4	67.5	0.370	0.444	0.592	0.740	0.887	1.035	1.183
	5	6.3	5.4	0.029	0.035	0.047	0.059	0.070	0.082	0.094
	10	13.0	11.0	0.060	0.072	0.096	0.120	0.144	0.168	0.192
	15	19.0	16.0	0.088	0.105	0.140	0.175	0.210	0.245	0.280
	20	25.0	22.0	0.118	0.141	0.188	0.235	0.282	0.329	0.376
	25	31.0	27.0	0.145	0.174	0.232	0.290	0.348	0.406	0.464
	30	38.0	32.0	0.175	0.210	0.280	0.350	0.420	0.490	0.560
	40	50.0	43.0	0.233	0.279	0.372	0.465	0.558	0.651	0.744
	50	63.0	54.0	0.293	0.351	0.468	0.585	0.702	0.819	0.936
	75	94.0	81.0	0.438	0.525	0.700	0.875	1.050	1.225	1.400
100	126.0	108.0	0.585	0.702	0.936	1.170	1.404	1.638	1.872	

Technical Data 5: Required Air Volume

8. Required air volume

The required air volume, which is the amount of air that is required for operating the rotary cylinder at the prescribed speed, is necessary for selecting the F.R.L. equipment or the pipe size.

The amount of air requirement of rotary actuator = $0.06 \times V \times (P/0.1)/t$ L/min(ANR)

V : Inner volume = cm³

P : Absolute pressure = {Operating pressure (MPa) + 0.1}

t : Operating time = s

Calculate the required air volume separately for the linear motion part and the rotary motion part. The required air volume for operating the linear motion and rotary motion parts simultaneously is the total of the individually obtained values.

Calculation example: Obtain the required air volumes to be used from the operation chart shown below.

Model: **MRQBS32-50CA-A73** Operating pressure: 0.5MPa

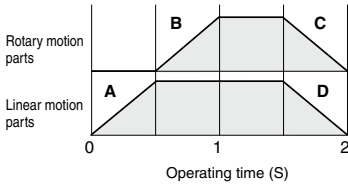

Calculate the amount of air requirement for A, B, C and D respectively.

$$A = 0.06 \times 40.2 \times \{(0.5 + 0.1)/0.1\}/0.5 = 28.9\text{L/min}$$

$$B = 0.06 \times 4.88 \times \{(0.5 + 0.1)/0.1\}/0.5 = 3.5\text{L/min}$$

$$C = B = 3.5\text{L/min}$$

$$D = 0.06 \times 33.7 \times \{(0.5 + 0.1)/0.1\}/0.5 = 24.3\text{L/min}$$

Since operation is simultaneous at C and D, total the respective amounts of air requirement.

$$C + D = 3.5 + 24.3 = 27.8\text{L/min}$$

Rotary Cylinder

MRQ Series

Size: 32, 40

How to Order

MRQ **B** **S** **32** - **50** **C** **A** - **J79W** -

● **Made to Order or port type**

Refer to page 427 for the Made to Order details.

Nil	Rc 1/8
XF*	G 1/8
XN*	NPT 1/8

* The combination with Made to Order is not available.

● **Mounting type**

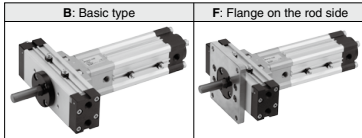

● **Size/Standard stroke (mm)**

32	5, 10, 15, 20, 25, 30, 40, 50, 75, 100
40	

* Refer to pages 436 and 437 for middle and long strokes other than standard stroke.

● **Air cushion**

C	With air cushion on the linear motion parts
N	Without air cushion on the linear motion parts

● **Number of auto switches**

Linear motion	Rotation		
	0	1	2
0	—	OS	O2
1	SO	SS	S2
2	2O	2S	Nil

● **Auto switch**

Nil	Without auto switch (built-in magnet)
-----	---------------------------------------

* For the applicable autoswitch model, refer to the table below.

Nil	Standard
X	Made to Order

● **Rotation angle**

A	80 to 100°
B	170 to 190°

Applicable Auto Switches (Common for the linear and the rotary motion parts)

Refer to pages 929 to 983 for further information on auto switches.

Type	Special function	Electrical entry	Indicator light	Wiring (Output)	Load voltage		Auto switch model		Lead wire length (m) *				Pre-wired connector	Applicable load			
					DC	AC	Perpendicular	In-line	0.5 (Nil)	3 (L)	5 (Z)	None (N)					
Solid state auto switch	-	Grommet	Yes	3-wire (NPN)	5 V, 12 V	-	F7NV	F79	●	●	○	-	○	IC circuit	Relay, PLC		
				3-wire (PNP)			F7VP	F7P	●	●	○	-	○				
		Connector		2-wire	12 V		F7BV	J79	●	●	○	-	○				
	Diagnostic indicator (2-color)	Grommet		3-wire (NPN)	5 V, 12 V		F7N WV	F79W	●	●	○	-	○	IC circuit			
				3-wire (PNP)			F7PW	●	●	○	-	○					
		Connector		2-wire	12 V		F7B WV	J79W	●	●	○	-	○	-			
Water resistant (2-color)	Grommet	2-wire	5 V, 12 V	F7BAV**	F7BA**	-	●	○	-	○	IC circuit						
Diagnosis output (2-color)		4-wire (NPN)		F79F	●	●	○	-	○								
Reed auto switch	-	Grommet	Yes	3-wire (NPN equivalent)	-	5 V	-	A76H	●	●	-	-	-	IC circuit	Relay, PLC		
				Connector	-	200 V	A72	A72H	●	●	-	-	-				
				100 V	A73	A73H	●	●	●	-	-	-					
		Diagnostic indicator (2-color)		Grommet	2-wire	24 V	12 V	100 V or less	A80	A80H	●	●	-	-		-	IC circuit
								-	A73C	-	●	●	●	●		-	
				Connector				-	A80C	-	●	●	●	●		-	-
Diagnosis output (2-color)	Grommet	Yes/No/Yes/No	-	-	-	A79W	-	●	●	-	-	-	-				

** Although it is possible to mount water resistant type auto switches, note that the rotary actuator itself is not of water resistant construction.

* Lead wire length symbols: 0.5 m..... Nil (Example) A73C

3 m..... L (Example) A73CL

5 m..... Z (Example) A73CZ

None..... N (Example) A73CN

* Solid state auto switches marked with "○" are manufactured upon receipt of order.

* Refer to pages 970 and 971 for detailed solid state auto switches with pre-wired connectors.

● Since other auto switches are available other than those listed above, refer to page 434 for details on other applicable auto switches.

* Auto switch is shipped together (not assembled).

Standard Specifications

Fluid	Air (Non-lube)
Max. operating pressure (MPa)	0.7 MPa
Min. operating pressure (MPa)	0.15 MPa
Ambient and fluid temperature	0 to 60°C (No freezing)
Mounting	Basic type, Rod side flange type





Made to Order

(Refer to pages 436 and 437 for details.)

Symbol	Specifications/Description
X1	Intermediate stroke
X2	Rod-end female thread
X5	Change of angle adjustable range
X10	Long Stroke (101 to 200 mm)

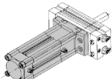
Linear Motion Parts, Rotary Motion Parts/Specifications

Linear motion parts	Size	32	40	
		Piston speed	50 to 500 mm/s	
	Cushion	With air cushion, Without air cushion		
	Port size	Rc 1/8		
Rotary motion parts		Output torque (At 0.5 MPa)	1 N·m	1.9 N·m
		Rotation time adjustment range	0.2 to 1 ^S /90°	
		Cushion	None	
		Allowable kinetic energy	0.023J	0.028J
		Port size	1/8, M5 x 0.8 (The port is plugged for delivery.)	
	Backlash	2° or less		

* For detailed explanation of effective output, refer to the description on page 422.

Linear Motion Parts/Standard Stroke

Size	Standard stroke (mm)
32, 40	5, 10, 15, 20, 25, 30, 40, 50, 75, 100

* Refer to page 436 for other intermediate strokes.

Weight

Size	Rotating angle	Basic weight (g)	Add'l stroke weight (g/mm)	Flange (g)
32	80° to 100°	1400	4	500
	170° to 190°	1500		
40	80° to 100°	2100	5	500
	170° to 190°	2300		

Calculation: (Example) **MRQBS32-50CA**

•Basic weight	1400 g
•Stroke additional weight	$4 \times 50 = 200 \text{ g}$
	Total 1600 g

* For the weight of auto switch alone, refer to pages 937 to 983.

Symbol

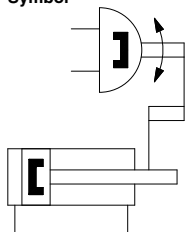

Possible to Exchange Basic Type with Flange Type

Specify with the part numbers shown below when ordering flange parts.

Size	Part no.
32	P317010-7
40	P317020-7

Attached parts: Flange 1 piece
Hexagon socket head cap screw 4 pieces

MRQ Series

Rotating Direction

When the pressure is applied from the A port, the rod rotates clockwise.

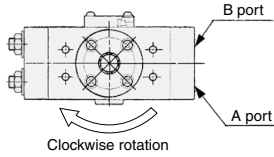

Allowable Lateral Load to the Piston Rod End

Using friction fittings makes it easier to mount the load to the piston rod end.

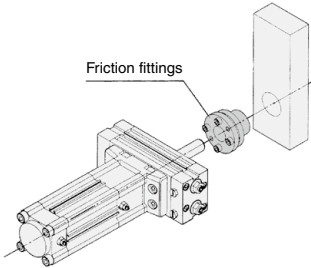

Rotation Angle Adjustable Range/Rotating Angle

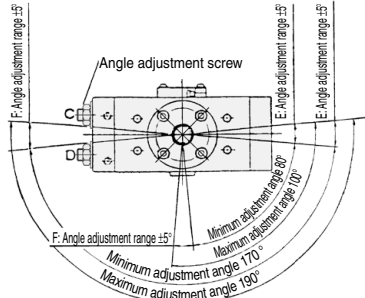

- Note) • Can be adjusted $\pm 5^\circ$ at the rotating ends.
 • When the cylinder is pressurized from port B, range E can be adjusted by regulating angle adjustment screw C.
 When the cylinder is pressurized from port A, range F can be adjusted by regulating angle adjustment screw D.

Manufacturers of Friction Fittings/Model

Size	Miki Pully Co., Ltd. (Position lock)	ISEL Co., Ltd. (Mechanical lock)
32	PSL-K-12	MA-12-26
40	PSL-K-14	MA-14-28

* Please consult with manufacturers concerning further information on specifications.

Size	Adjusting angle per 1 rotation of angle adjusting screw
32	5.7°
40	4.8°

Backlash

The rotary motion part has a structure that does not generate backlash. However, the pinion gear has a hexagonal hole, and a slight clearance exists between the hexagonal hole of the rotary motion part and the hexagonal flats of the piston rod of the linear part.

This clearance generates a backlash in the rotational direction of the piston rod.

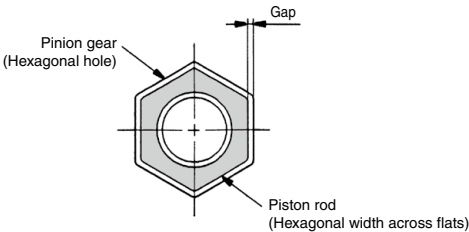

⚠ Precautions

| Be sure to read this before |
 | handling the products. |
 | For safety instructions as well as |
 | rotary actuator and auto switch |
 | precautions, refer to the "Handling |
 | Precautions for SMC Products" |
 | and the "Operation Manual" of |
 | each product on the SMC website: |
 | <https://www.smcworld.com> |

⚠ Caution

The angle adjustment bolt is adjusted to a random position within the adjustable rotating range when shipped. Readjust the angle as needed before using.

Construction

* Part unnecessary for models without a cushion.

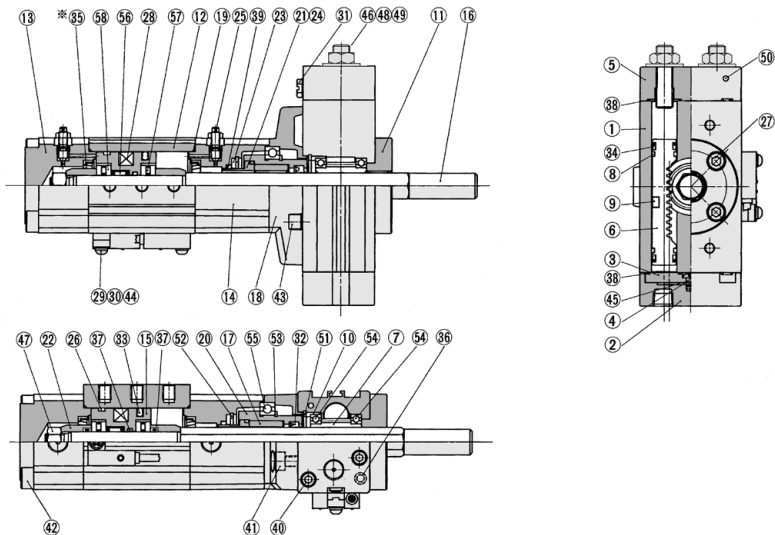

Component Parts

No.	Description	Material	Note
①	Body	Aluminum alloy	Anodized
②	Cover	Aluminum alloy	Anodized
③	Plate	Aluminum alloy	Chromated
④	Seal	NBR	
⑤	End cover	Aluminum alloy	Anodized
⑥	Piston	Stainless steel	
⑦	Pinion gear	Chrome molybdenum steel	
⑧	Wearing	Resin	
⑨	Magnet	-	
⑩	Bearing color	Aluminum alloy	Anodized
⑪	Steady brace cover	Aluminum alloy	Anodized
⑫	Tube	Aluminum alloy	Anodized
⑬	Head cover	Aluminum alloy	Anodized
⑭	Rod cover	Aluminum alloy	Platinum silver
⑮	Piston	Aluminum alloy	Chromated
⑯	Piston rod	Stainless steel	
⑰	Non-rotating guide	Sintered metallic	
⑱	Flange	Aluminum alloy	Platinum silver
⑲	Tube gasket	NBR	
⑳	Rod packing guide	Aluminum alloy	Anodized
㉑	Color	Aluminum alloy	Anodized
㉒	Cushion ring	Rolled steel	Electroless nickel plated
㉓	O-ring retainer	Aluminum alloy	Chromated
㉔	O-ring	NBR	
㉕	Cushion valve assembly	Steel wire	
㉖	Wearing	Resin	
㉗	Hexagon socket head cap screw	Chrome molybdenum steel	
㉘	Plastic magnet	Magnetic material	
㉙	Switch mounting nut	Rolled steel	
㉚	Switch spacer	Resin	
㉛	Plug	Brass	Electroless nickel plated
㉜	Rod packing	NBR	
㉝	Piston seal	NBR	
㉞	Piston seal	NBR	
㉟	Cushion seal	NBR	
㊱	O-ring	NBR	
㊲	O-ring	NBR	
㊳	O-ring	NBR	
㊴	O-ring	NBR	

Component Parts

No.	Description	Material	Note
④⑩	Hexagon socket head cap screw	Stainless steel	
④①	Hexagon socket head cap screw	Stainless steel	
④②	Hexagon socket head cap screw	Stainless steel	
④③	Hexagon socket head cap screw	Stainless steel	
④④	Round head Phillips screw	Steel wire	
④⑤	Round head Phillips screw	Steel wire	
④⑥	Hexagon socket head set screw	Steel wire	
④⑦	Compact hexagon nut	Stainless steel	
④⑧	Hexagon small nut	Steel wire	
④⑨	Seal washer	Steel wire	
⑤①	Steel ball	Stainless steel	
⑤②	R-shape retaining ring	Steel wire	
⑤③	R-shape retaining ring	Steel wire	
⑤④	Bearing	Bearing steel	
⑤⑤	Bearing	Bearing steel	
⑤⑥	Shell type needle roller bearing	Bearing steel	
⑤⑦	Thrust needle roller bearing	Bearing steel	
⑤⑧	Bearing ring	Bearing steel	

Replacement Parts

Description	Size	
	32	40
Spare parts assembly part no.	P31701-1	P31702-1
No.	Description	Quantity
④	Seal	1
⑧	Wearing	4
⑱	Tube gasket	2
㉖	Wearing	1
㉜	Rod packing	1
㉝	Piston seal	1
㉞	Piston seal	4
㉟	O-ring	4
㊱	O-ring	4
㊲	O-ring	1
㊴	Seal washer	2

A grease pack (10 g) is included. When you need an additional grease pack, order using the following part number.

Replacement part/Grease pack part no. : GR-S-010 (10g)

* Individual part cannot be shipped.

MRQ Series

Size 32



Basic Type: MRQBS32

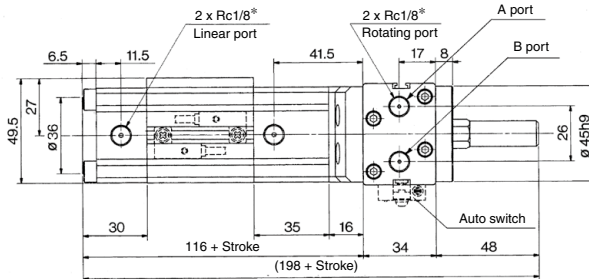
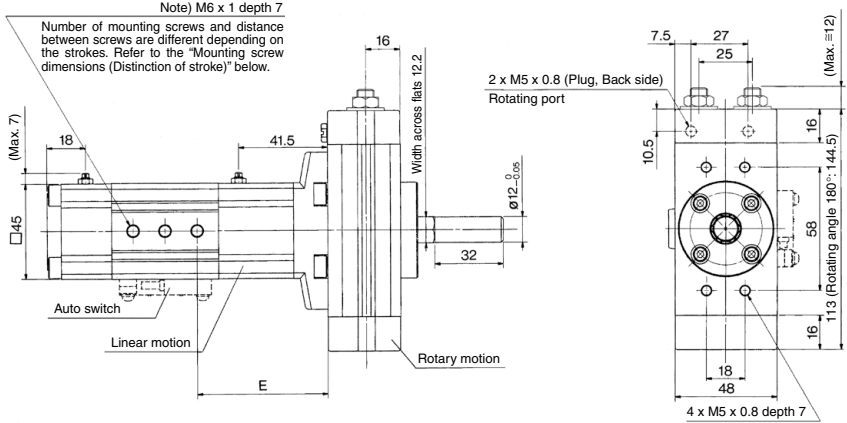

In addition to Rc 1/8, G1/8 and NPT 1/8 are also available.

Mounting Screw Dimensions (Distinction of stroke)

Stroke	Mounting screw 3 pcs.						Mounting screw 4 pcs.			
	5	10	15	20	25	30	40	50	75	100
Y	12.5	12.5	15	15	20	20	15	17.5	25	30
Q	-	-	-	-	-	-	20	20	20	30
E	58.5	61	61	63.5	61	63.5	63.5	66	71	73.5

(mm)



Flange Type: MRQFS32

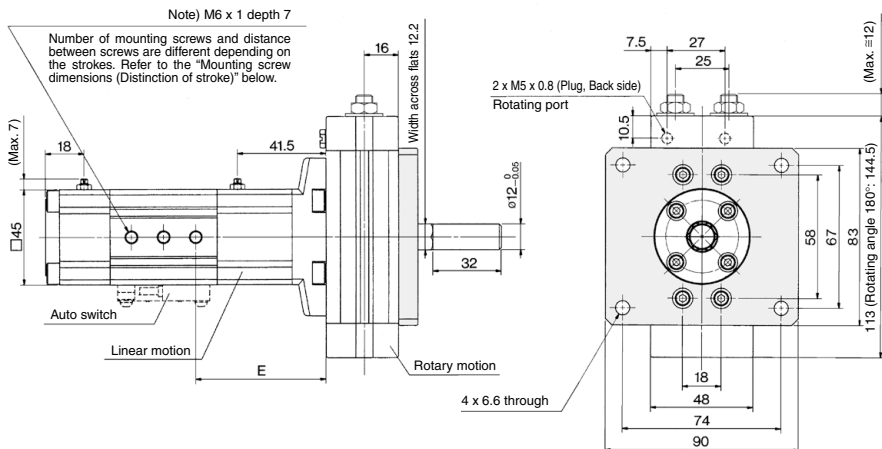

In addition to Rc 1/8, G1/8 and NPT 1/8 are also available.

Mounting Screw Dimensions (Distinction of stroke)

Stroke	Mounting screw 3 pcs.						Mounting screw 4 pcs.			
	5	10	15	20	25	30	40	50	75	100
Y	12.5	12.5	15	15	20	20	15	17.5	25	30
Q	-	-	-	-	-	-	20	20	20	30
E	58.5	61	61	63.5	61	63.5	63.5	66	71	73.5

(mm)

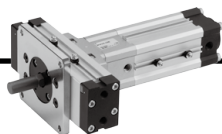

Flange Type: MRQFS40

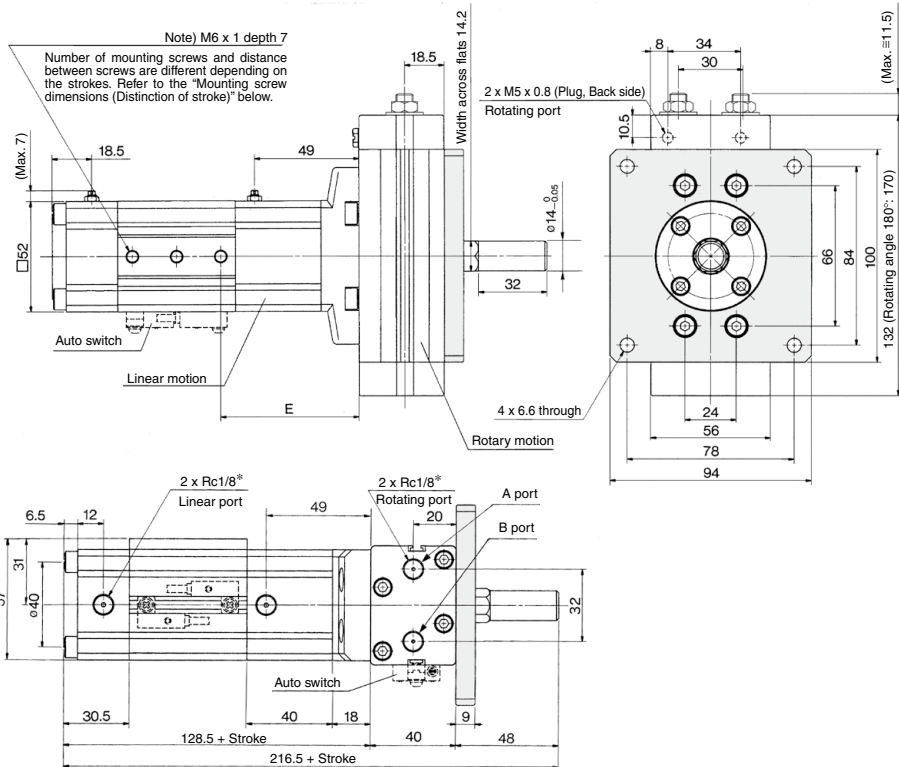

In addition to Rc 1/8, G1/8 and NPT 1/8 are also available.

Mounting Screw Dimensions (Distinction of stroke)

Stroke	Mounting screw 3 pcs.					Mounting screw 4 pcs.				
	5	10	15	15	25	30	40	50	75	100
Y	12.5	15	15	15	20	15	17.5	17.5	25	30
Q	-	-	-	-	-	20	20	20	20	30
E	68	68	70.5	70.5	70.5	68	70.5	75.5	80.5	83

MRQ Series

With Auto Switch

Refer to pages 937 to 983 concerning further information on specifications of the auto switch single body.

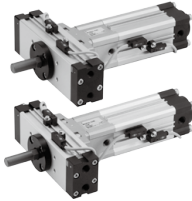

Applicable Auto Switch

In addition to the applicable auto switches indicated in How to Order, the following auto switches can be also mounted.
Refer to page 959 concerning further information on specifications of the auto switch single body.

Auto switch type	Part no.	Electrical entry (Fetching direction)	Feature
Solid state	D-F7NT	Grommet (In-line)	With timer

Operating Range/Hysteresis/Proper Mounting Positions of Auto Switch

Linear motion parts

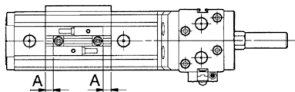

Linear motion parts		Size	D-A7/A8	D-F7□, F7□V, J79, J79C, F7□W, F7□WV, J79W, F7BA, F7BAV	D-F79F
Linear motion parts	Operating range (mm)	32	12	6	8
		40	11		7
	Hysteresis (mm)	32	2	1	1
		40			
Proper mounting position A (mm)		32	8.5(9)	9	9
		40	11(11.5)	11.5	11.5

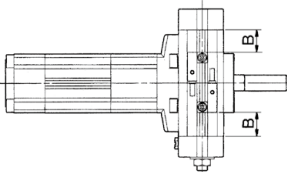

Rotary motion parts		Size	Rotating angle	D-A7/A8	D-F7□, F7□V, J79, J79C, F7□W, F7□WV, J79W, F7BA, F7BAV	D-F79F	
Rotary motion parts	Operating range (Degree)	32	—	55	28	40	
		40		46	27	32	
	Hysteresis angle (Degree)	32		10	4	7	
		40		7	3	4	
	Proper mounting position B (mm)	32		80 to 100°	24.5 (25)	25	29
				170 to 190°	32 (32.5)	32.5	36.5
40		80 to 100°	31.5 (32)	32	36		
		170 to 190°	41 (41.5)	41.5	45.5		

The values in parentheses are of D-A72, A7□H, A80H

Note) Since the above values are only provided as a guideline, they are not guaranteed. In the actual setting, adjust them after confirming the auto switch performance.

Mounting and Moving Method of Auto Switch

Auto switch mounting bracket part no.

BQ-2

* Common for MRQ32 and 40

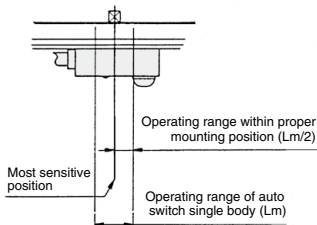

Operating angle : The value of the individual auto switch's movement range Lm converted into the shaft's rotation angle

Hysteresis angle : The value of the auto switch's hysteresis as represented by an angle

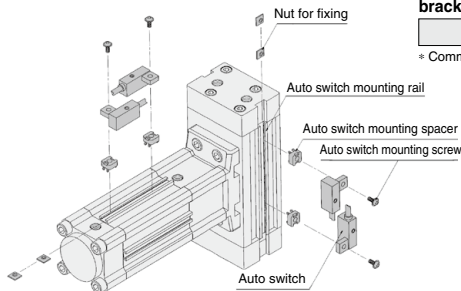

- Slide the auto switch mounting spacer and place it on the auto switch mounting position of the body. (At this time, verify that the auto switch mounting nut that is inserted in the auto switch mounting rail is placed simultaneously in the auto switch mounting position.)
- Engage the tongue portion of the auto switch mounting arm into the groove portion of the auto switch mounting spacer.
- Lightly screw the auto switch mounting screw into the auto switch mounting nut, via the hole in the auto switch mounting arm.
- After verifying the detection position, tighten the mounting screw to secure the auto switch in place. (The tightening torque of the M3 screw is approximately 0.5 N·m.)
- The detection position can be changed under the conditions described in step ③.

Auto Switch Mounting Dimensions

Reed switch

D-A7□/A80

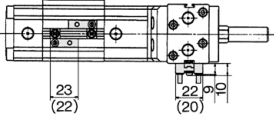

(In parentheses) are the dimensions of "A72".

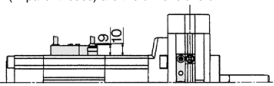

D-A7□H

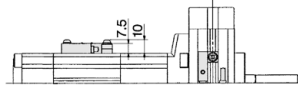
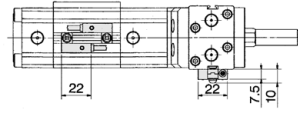

D-A73C/A80C

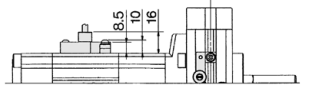
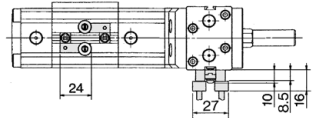

D-A79W

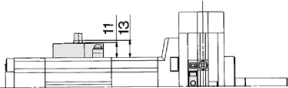
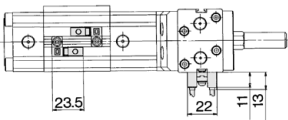

Solid state switch

D-F7□/F7□F/F7BAL/F7NT/J79

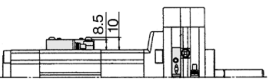
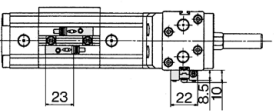

D-J79C

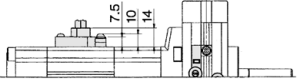
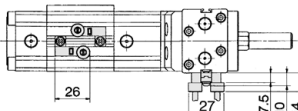

D-F7□W/J79W

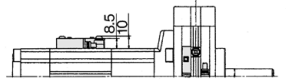
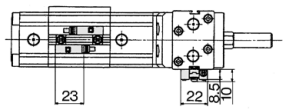

D-F7□V

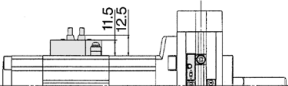
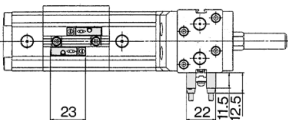

⚠ Caution

Be sure to read pages 932 to 936 before handling the products when using auto switches.



Please contact SMC for detailed dimensions, specifications and lead times.

1 Intermediate Stroke Symbol **-X1**

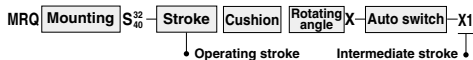

For intermediate strokes other than standard strokes, the full length is shortened by cutting the linear motion side according to the stroke.

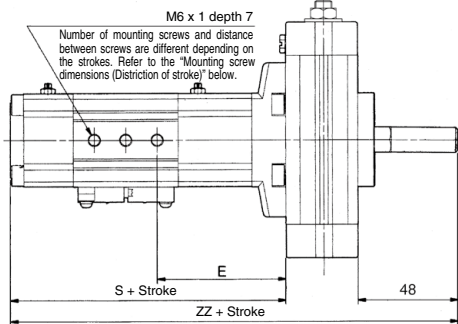

Mounting Screw Dimensions (Distinction of stroke)

Mounting screw 3 pcs.

Mounting screw 4 pcs.

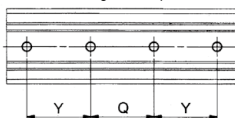
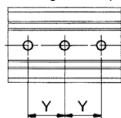

Size	Stroke	Y	Q	E	Mounting screw
32	1 to 4	12.5	—	$58.5 - (5 - \text{Stroke})/2$	3
	6 to 9			$61 - (10 - \text{Stroke})/2$	
	11 to 14			$61 - (15 - \text{Stroke})/2$	
	16 to 19	15		$63.5 - (20 - \text{Stroke})/2$	
	21 to 24			$61 - (25 - \text{Stroke})/2$	
	26 to 29	20		$63.5 - (30 - \text{Stroke})/2$	
	31 to 39			$63.5 - (40 - \text{Stroke})/2$	
	41 to 49	17.5		$66 - (50 - \text{Stroke})/2$	
	51 to 65			$66 - (65 - \text{Stroke})/2$	
	66 to 74	25		$71 - (75 - \text{Stroke})/2$	
76 to 90	30		$68.5 - (90 - \text{Stroke})/2$		
91 to 99		30	$73.5 - (100 - \text{Stroke})/2$		
40	1 to 4	12.5	—	$68 - (5 - \text{Stroke})/2$	3
	6 to 9			$68 - (10 - \text{Stroke})/2$	
	11 to 14			$70.5 - (15 - \text{Stroke})/2$	
	16 to 19	15		$68 - (20 - \text{Stroke})/2$	
	21 to 24			$70.5 - (25 - \text{Stroke})/2$	
	26 to 29	20		$68 - (30 - \text{Stroke})/2$	
	31 to 39			$70.5 - (40 - \text{Stroke})/2$	
	41 to 49	17.5		$75.5 - (50 - \text{Stroke})/2$	
	51 to 65			$75.5 - (65 - \text{Stroke})/2$	
	66 to 74	25		$80.5 - (75 - \text{Stroke})/2$	
76 to 90	30		$78 - (90 - \text{Stroke})/2$		
91 to 99		30	$83 - (100 - \text{Stroke})/2$		

Size	S	ZZ
32	116	198
40	128.5	216.5

2 Rod End Female Thread Symbol **-X2**

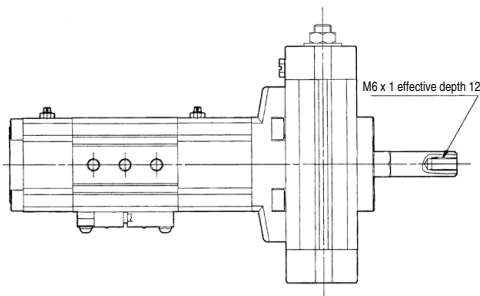
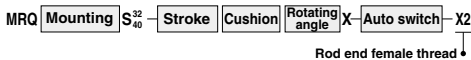

3 Non-standard Angle Adjustment Range Symbol **-X5**



Angle adjustment range

* For rotating angle, fill in either A (90° type) or B (180° type). The standard angle adjustment range of $\pm 5^\circ$ (one side) is changed to $+5^\circ_{-95^\circ}$ in this type.

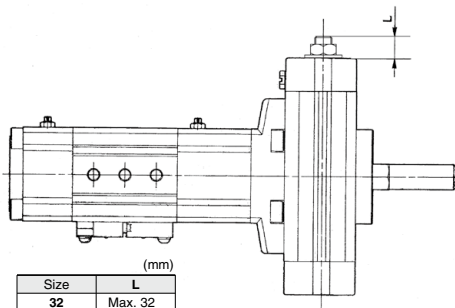

Size	L
32	Max. 32
40	Max. 31.5

Possible to Change the Specifications from the Basic Type to "-X5"

Specify the part number for hexagon socket head cap screw for angle adjustment referring to the list below.

Size	Part no.	Attached parts:	
32	P317010-13	Hexagon socket head cap screw	1 pc.
40		Hexagon nut	1 pc.
		Seal washer	1 pc.

* One set of the actuator requires two sets of the hexagon socket head cap screws.

