

180° Angular Type Air Gripper

MHY2/MHW2 Series

ø10, ø16, ø20, ø25

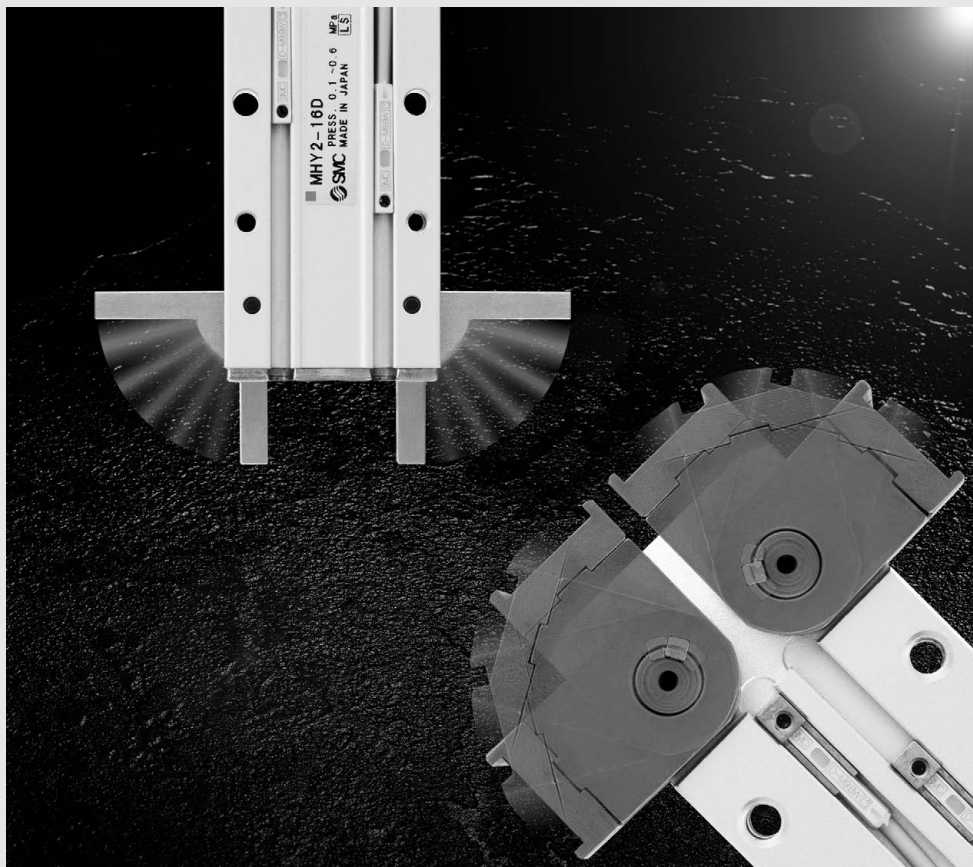

180° Angular Type Air Gripper

Cam Type

Rack & Pinion Type

MHY2/MHW2 Series

MHY2 Series/Cam Type

Light and compact size in small bore sizes

Model	Bore size (mm)	Gripping moment * (N·m)	Over length L (mm)	Weight (g)
MHY2-10D	10	0.16	71	70
MHY2-16D	16	0.54	84	150
MHY2-20D	20	1.10	106	320
MHY2-25D	25	2.28	131	560

* At the pressure of 0.5 MPa

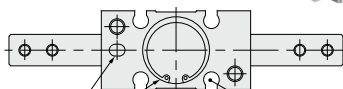

Improved mounting repeatability

Auto switch mounting at 4 locations

Resistance to dusty environments

Reduced opening sizes helps prevent foreign objects from entering.

Stainless steel fingers are standard.

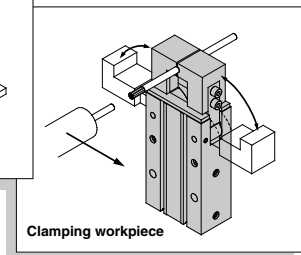
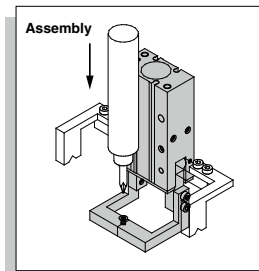
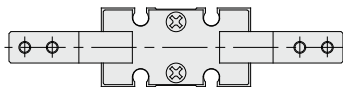
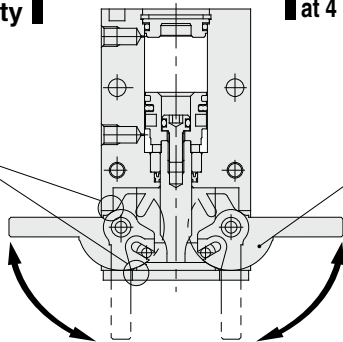

Series Variations

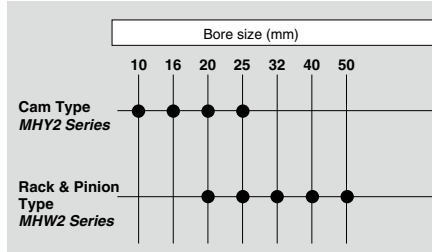

MHW2 Series/Rack & Pinion Type

Unique seal design allows shorter total length construction and constant gripping force when opening and closing fingers. (PAT.PEND)

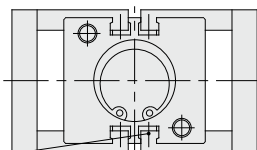
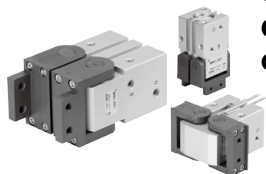

Model	Bore size (mm)	Gripping moment* (N·m)	Overlength L(mm)	Weight (g)
MHW2-20D	20	0.30	68	300
MHW2-25D	25	0.73	78	510
MHW2-32D	32	1.61	93.5	905
MHW2-40D	40	3.70	117.5	2135
MHW2-50D	50	8.27	154	5100

* At the pressure of 0.5 MPa

Auto switch mounting at 4 locations

Key connection is ideal for impact resistance.

Key connection between finger and shaft prevents finger angle slippage during impact.

Two finger types available.

Flat finger type

Right angle finger type

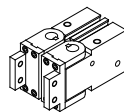
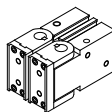

Dustproof construction

Seal arrangement protects gripper from harsh dusty environments.

Bearings are standard.

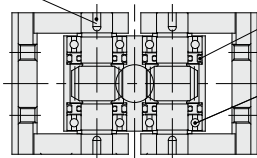

Clamping workpiece

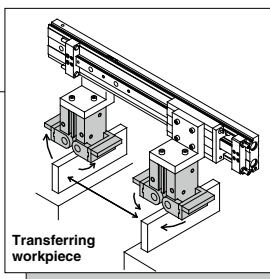
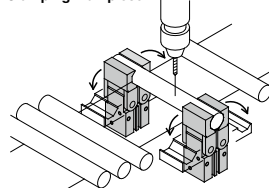

Transferring workpiece

INDEX

Applicable auto switch

Page

Solid state switch
D-M9/M9□W type

836 to 842

843 to 850

MHY2/MHW2 Series Model Selection

Model Selection

Selection Procedure



Step 1 Confirmation of Gripping Force



Example

Workpiece mass: 0.05 kg

Guidelines for the selection of the gripper with respect to workpiece mass

- Although conditions differ according to the workpiece shape and the coefficient of friction between the attachments and the workpiece, select a model that can provide a gripping force of 10 to 20 times the workpiece mass, or more.
- If high acceleration, deceleration or impact forces are encountered during motion, a further margin of safety should be considered.

Example) For setting the gripping force to be at least 20 times the work weight;

$$\text{Required gripping force} = 0.05 \text{ kg} \times 20 \times 9.8 \text{ m/s}^2 = 10 \text{ N min.}$$

MHY2-16D

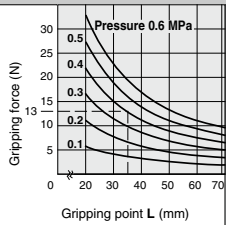

• When **MHY2-16D** is selected, the gripping force is determined to be 13 N according to the gripping point distance (L = 35 mm) and the pressure (0.4 MPa).

• The gripping force is 26 times the workpiece mass and therefore satisfies a gripping force setting value of 20 times or more.

Gripping point L = 35 mm

Operating pressure: 0.4 MPa

Effective Gripping Force

MHY2/MHW2 Series Double Acting

- Indication of effective gripping force
- The effective gripping force shown in the graphs to the right is expressed as F, which is the impellent force of one finger, when both fingers and attachments are in full contact with the workpiece as shown in the figure below.

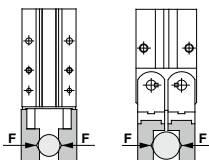

External grip

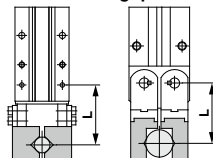

MHY2-10D

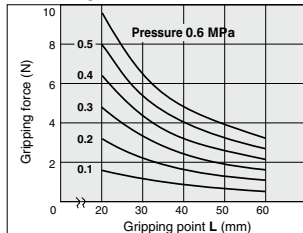

MHY2-20D

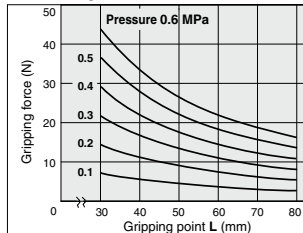

MHY2-16D

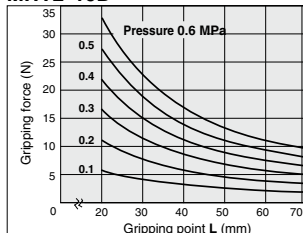

MHY2-25D

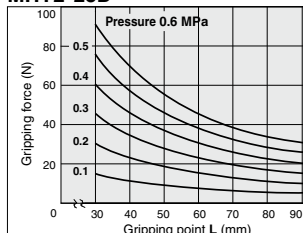

MHW2-20D

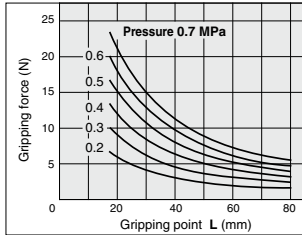

MHW2-32D

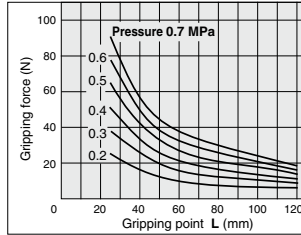

MHW2-50D

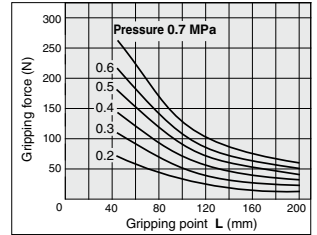

MHW2-25D

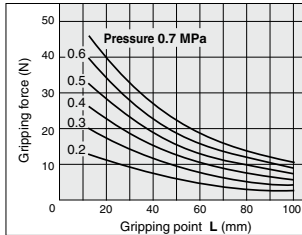

MHW2-40D

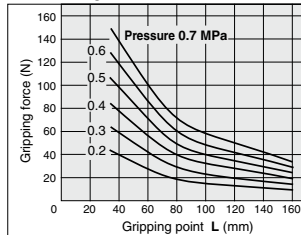

Step 2 Confirmation of Gripping Point

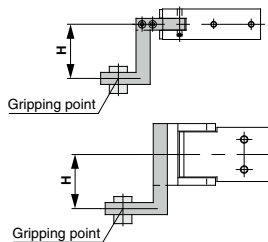

MHY

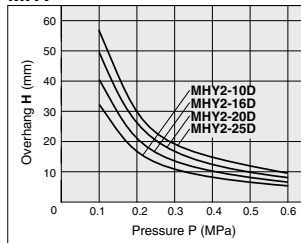

MHW

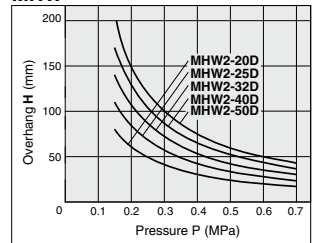

- Workpiece should be held at a point within the range of overhanging distance (H) for a given pressure indicated in the tables on the right.
- When the workpiece is held at a point outside of the recommended range for a given pressure, it may cause adverse effect on the product life.

MHY2/MHW2 Series Model Selection

Step 3 Confirmation of Moment of Inertia of Attachments

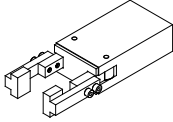

Confirm the moment of inertia for the attachment at one side.
Calculate the moment of inertia for A and B separately as shown in the figures on the right.

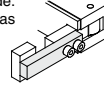

A part

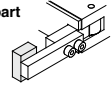

B part

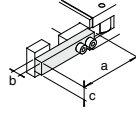
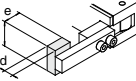
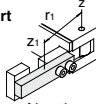
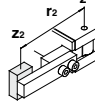
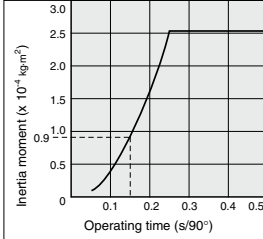
Procedure	Calculation	Calculation example
<p>1. Check the operating conditions, dimensions of attachment, etc.</p>	<p>A part</p>  <p>B part</p> 	<p>Operating model: MHY2-16D Opening time: 0.15 s a = 40 (mm) b = 7 (mm) c = 8 (mm) d = 5 (mm) e = 10 (mm) f = 12 (mm)</p>
<p>2. Calculate the moment of inertia of attachment.</p>	<p>A part</p>  <p>Calculation of weight $m_1 = a \times b \times c \times \text{Specific gravity}$</p> <p>Moment of inertia around Z₁ axis $I_{z1} = \{m_1(a^2 + b^2)/12\} \times 10^{-6}$</p> <p>Moment of inertia around Z axis $I_A = I_{z1} + m_1 r_1^2 \times 10^{-6}$</p> <p>B part</p>  <p>Calculation of weight $m_2 = d \times e \times f \times \text{Specific gravity}$</p> <p>Moment of inertia around Z₂ axis $I_{z2} = \{m_2(d^2 + e^2)/12\} \times 10^{-6}$</p> <p>Moment of inertia around Z axis $I_B = I_{z2} + m_2 r_2^2 \times 10^{-6}$</p> <p>Total moment of inertia $I = I_A + I_B$ (* Constant for unit conversion)</p>	<p>Material of attachment: Aluminum alloy (Specific gravity = 2.7) r₁ = 37 (mm)</p> <p>m₁ = 40 × 7 × 8 × 2.7 × 10⁻⁶ = 0.006 (kg)</p> <p>I_{z1} = {0.006 × (40² + 7²)/12} × 10⁻⁶ = 0.8 × 10⁻⁶ (kg·m²)</p> <p>I_A = 0.8 × 10⁻⁶ + 0.006 × 37² × 10⁻⁶ = 9.0 × 10⁻⁶ (kg·m²)</p> <p>r₂ = 47(mm)</p> <p>m₂ = 5 × 10 × 12 × 2.7 × 10⁻⁶ = 0.002 (kg)</p> <p>I_{z2} = {0.002 × (5² + 10²)/12} × 10⁻⁶ = 0.02 × 10⁻⁶ (kg·m²)</p> <p>I_B = 0.02 × 10⁻⁶ + 0.002 × 47² × 10⁻⁶ = 4.4 × 10⁻⁶ (kg·m²)</p> <p>I = 9.0 × 10⁻⁶ + 4.4 × 10⁻⁶ = 13.4 × 10⁻⁶ = 0.13 × 10⁻⁴ (kg·m²)</p>
<p>3. Determine the allowable moment of inertia from the graph.</p>	<p>MHY2-16D</p> 	<p>The moment of inertia is determined to be 0.9 × 10⁻⁴ (kg·m²) according to the operating time (0.15 s) from the graph to the left.</p>
<p>4. Confirm the moment of inertia of one attachment is within the allowable range.</p>	<p>Moment of inertia of attachment < Allowable moment of inertia</p>	<p>0.13 × 10⁻⁴ (kg·m²) < 0.9 × 10⁻⁴ (kg·m²) Possible to use this model MHY2-16D completely.</p>

Symbol

Symbol	Definition	Unit
Z	Finger rotation axis	—
Z1	Axis on the center gravity of A part of attachment and parallel to Z	—
Z2	Axis on the center gravity of B part of attachment and parallel to Z	—
I	Total moment of inertia for attachment	kg·m ²
Iz1	Inertia moment around the Z1 axis of A part of attachment	kg·m ²
Iz2	Inertia moment around the Z2 axis of B part of attachment	kg·m ²

Symbol	Definition	Unit
IA	Moment of inertia around the Z axis of A part of attachment	kg·m ²
IB	Moment of inertia around the Z axis of B part of attachment	kg·m ²
m1	Weight of A part of attachment	kg
m2	Weight of B part of attachment	kg
r1	Distance between Z and Z1 axis	mm
r2	Distance between Z and Z2 axis	mm

Allowable Range of Moment of Inertia of Attachment

MHY2-10D

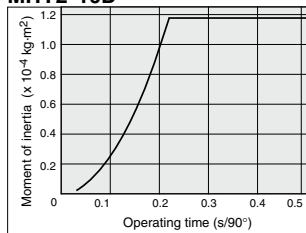

MHW2-20D

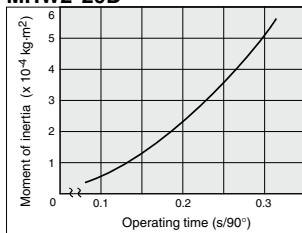

MHW2-50D

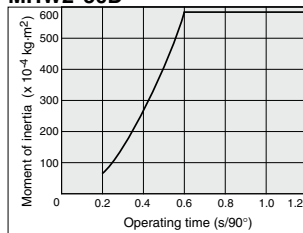

MHY2-16D

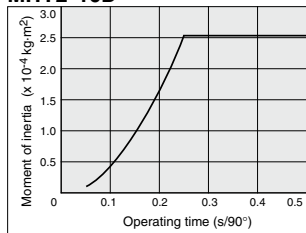

MHW2-25D

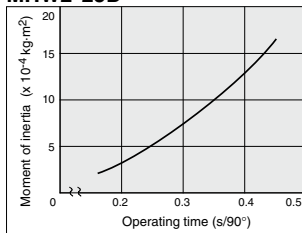

MHY2-20D

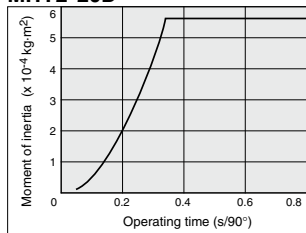

MHW2-32D

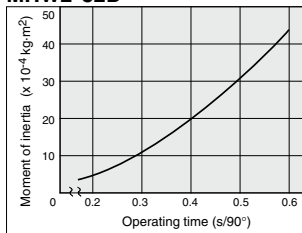

MHY2-25D

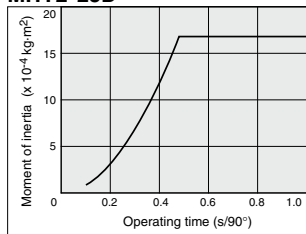

MHW2-40D

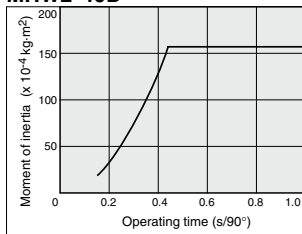

180° Angular Type Air Gripper Cam Type

MHY2 Series

∅10, ∅16, ∅20, ∅25

How to Order

MHY 2 - 16 D 2 - M9BW [] - []

Number of fingers

2	2 fingers
---	-----------

Bore size

10	10 mm
16	16 mm
20	20 mm
25	25 mm

Action

D	Double acting
---	---------------

Auto switch

Nil	Without auto switch (Built-in magnet)
-----	---------------------------------------

• **Made to Order**
Refer to page 837 for details.

• **Number of auto switches**

Nil	2 pcs.
S	1 pc.
n	n pc.

• **Finger option**

Nil: Standard tapped 2: Through-holes in opening/closing direction

Applicable Auto Switches / Refer to pages 929 to 983 for further information on auto switches.

Type	Special function	Electrical entry	Indicator light	Wiring (Output)	Load voltage		Auto switch model		Lead wire length (m)*				Pre-wired connector	Applicable load	
					DC	AC	Electrical entry direction		0.5 (Nil)	1 (M)	3 (L)	5 (Z)			
							Perpendicular	In-line							
Solid state auto switch	—	Grommet	Yes	3-wire(NPN)	5 V, 12 V	—	M9NV	M9N	●	●	●	○	○	Relay, PLC	
				3-wire(PNP)			M9PV	M9P	●	●	●	○	○		IC circuit
				2-wire	M9BV		M9B	●	●	●	○	○	—		
				3-wire(NPN)	M9NWV		M9NW	●	●	●	○	○	IC circuit		
				3-wire(PNP)	M9PWW		M9PW	●	●	●	○	○	IC circuit		
				2-wire	M9BWW		M9BW	●	●	●	○	○	—		
	Water resistant (2-color indicator)	Grommet	Yes	3-wire(NPN)	5 V, 12 V	—	M9NAV**	M9NA**	○	○	●	○	○	○	IC circuit
				3-wire(PNP)			M9PAV**	M9PA**	○	○	●	○	○	IC circuit	
				2-wire	M9BAV**		M9BA**	○	○	●	○	○	—		

** Water resistant type auto switches can be mounted on the above models, but in such case SMC cannot guarantee water resistance.

* Lead wire length symbols: 0.5 m Nil (Example) M9NW

1 m M (Example) M9NWM

3 m L (Example) M9NWL

5 m Z (Example) M9NWZ

* Auto switches marked with a "○" symbol are produced upon receipt of order.

Note 1) When using the 2-color indicator type, please make the setting so that the indicator is lit in red to ensure the detection at the proper position of the air gripper.

Specifications

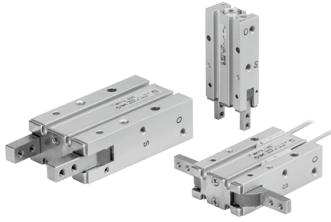

Fluid	Air
Operating pressure	0.1 to 0.6 MPa
Ambient and fluid temperature	-10 to 60°C
Repeatability	±0.2 mm
Max. operating frequency	60 c.p.m.
Lubrication	Not required
Action	Double acting
Auto switch (Option) ^{Note)}	Solid state auto switch (3-wire, 2-wire)

Note) Refer to pages 929 to 983 for further information on auto switches.

Symbol

Double acting: External grip

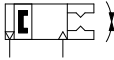

Model

Model	Bore size (mm)	Effective gripping force (1) (N·m)	Opening/Closing angle (Both sides)		Weight (2) (g)
			Opening side	Closing side	
MHY2-10D	10	0.16	180°	-3°	70
MHY2-16D	16	0.54			150
MHY2-20D	20	1.10			320
MHY2-25D	25	2.28			560

Note 1) At the pressure of 0.5 MPa

Note 2) Except auto switch



Made to Order

[Click here for details](#)

Symbol	Specifications/Description
-X4	Heat resistance (100°C)
-X5	Fluororubber seal
-X50	Without magnet
-X53	EPDM for seals, Fluorine grease
-X63	Fluorine grease
-X79	Grease for food processing machines, Fluorine grease
-X79A	Grease for food processing machines
-X81A	Anti-corrosive treatment of finger

• Refer to "How to Select the Applicable Model" on page 832.

• Refer to pages 832 and 833 for the details on effective holding force and allowable overhanging distance.

Moisture Control Tube IDK Series



When operating an actuator with a small diameter and a short stroke at a high frequency, the dew condensation (water droplet) may occur inside the piping depending on the conditions.

Simply connecting the moisture control tube to the actuator will prevent dew condensation from occurring. For details, refer to the [Web Catalog](#).

MHY2 Series

Construction

Closed condition

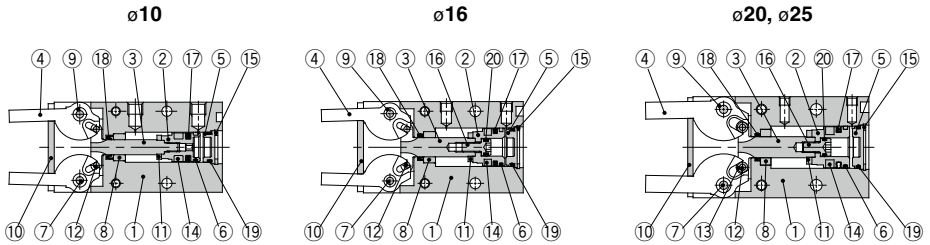

Open condition

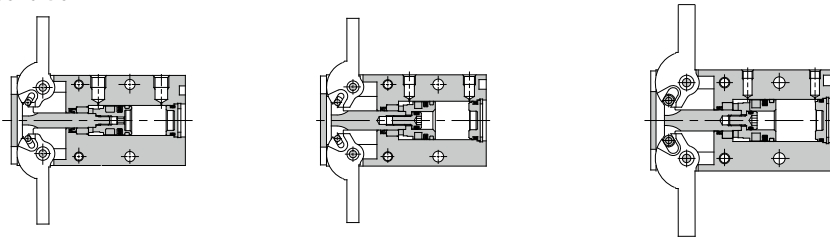

Component Parts

No.	Description	Material	Note
1	Body	Aluminum alloy	Hard anodized
2	Piston	ø10: Stainless steel ø16 to 25: Aluminum alloy	ø16 to 25: Chromated
3	Joint	Stainless steel	Heat treated
4	Finger	Stainless steel	Heat treated
5	Cap	Resin	
6	Wear ring	Resin	
7	Shaft	Stainless steel	Nitriding
8	Bushing A	Sintered alloy steel	
9	Bushing B	Sintered alloy steel	
10	End plate	Stainless steel	

No.	Description	Material	Note
11	Bumper	Urethane rubber	
12	Needle roller	High carbon chrome bearing steel	Heat treated
13	Joint roller	Carbon steel	Nitriding
14	Rubber magnet	Synthetic rubber	
15	Type C retaining ring	Carbon steel	Phosphate coated
16	Piston bolt	Stainless steel	
17	Piston seal	NBR	
18	Rod seal	NBR	
19	Gasket	NBR	
20	Gasket	NBR	

Replacement Parts

Description		MHY2-10	MHY2-16	MHY2-20	MHY2-25	Main parts
Seal kit		MHY10-PS	MHY16-PS	MHY20-PS	MHY25-PS	<ø10> 17 18 19 <ø16, ø20, ø25> 17 18 19 20
Finger assembly	MHY2-□D	MHY-A1001	MHY-A1601	MHY-A2001	MHY-A2501	4 9
	MHY2-□D2	MHY-A1001-2	MHY-A1601-2	MHY-A2001-2	MHY-A2501-2	
Joint assembly		MHY-A1002	MHY-A1602	MHY-A2002	MHY-A2502	<ø10, ø16> 3 12 <ø20, ø25> 3 12 13
Piston assembly		MHY-A1003	MHY-A1603	MHY-A2003	MHY-A2503	<ø10> 2 6 11 14 <ø16, ø20, ø25> 2 6 11 14 16

* Order 1 piece of finger assembly per one unit.

Replacement part/grease pack part no. : MH-G04 (30 g)

Dimensions

MHY2-10D

Pin hole positioning

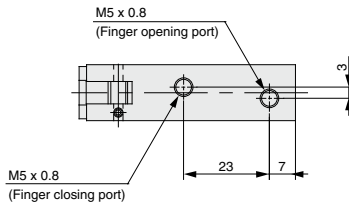
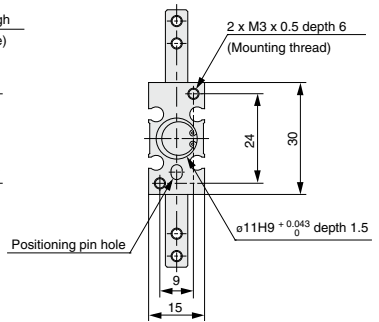
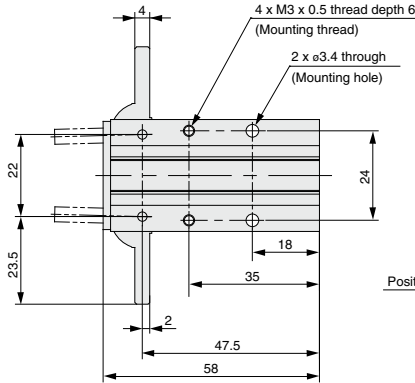
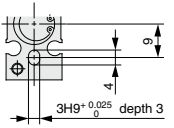
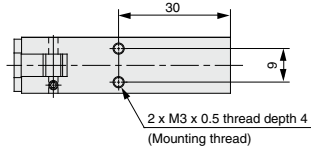
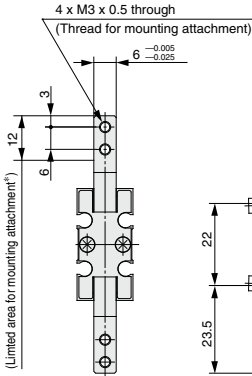

Auto Switch Mounting Groove Dimensions

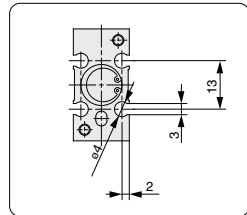

MHY2-10D2

Opening/Closing direction through-hole type

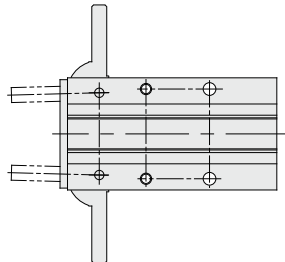
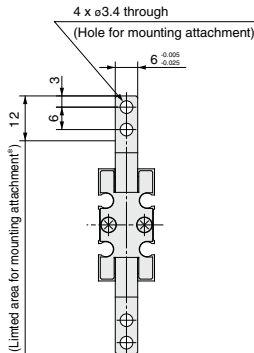

* Do not extend the attachment from limited area for mounting to avoid interference with the attachment or main body.

MHY2 Series

Dimensions

MHY2-16D

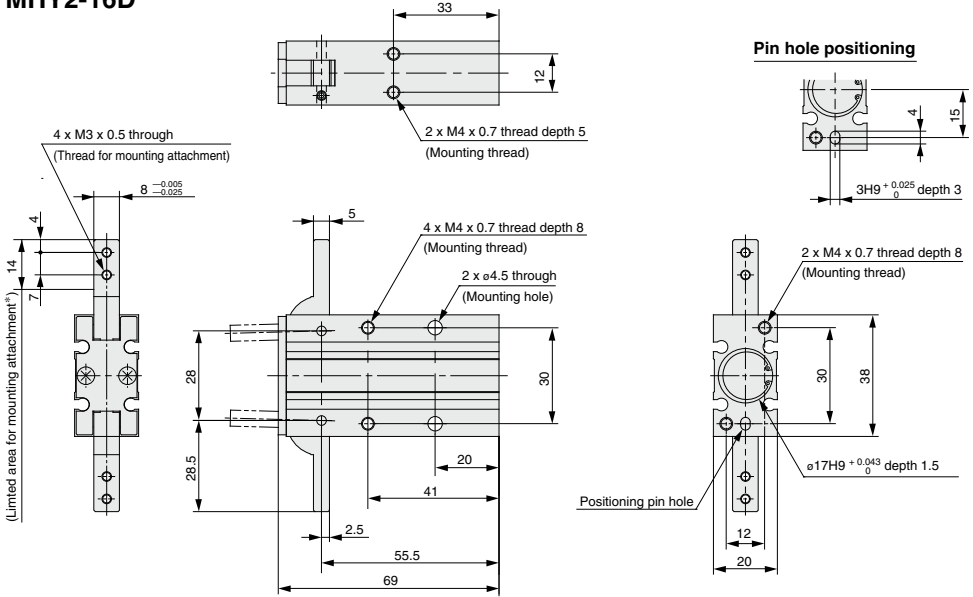

Auto Switch Mounting Groove Dimensions

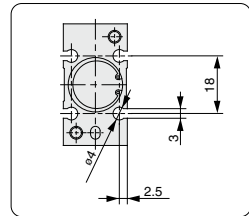

MHY2-16D2 Opening/Closing direction through-hole type

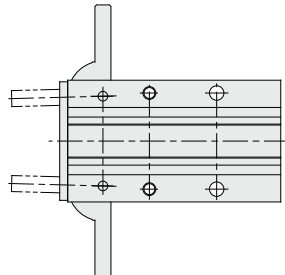
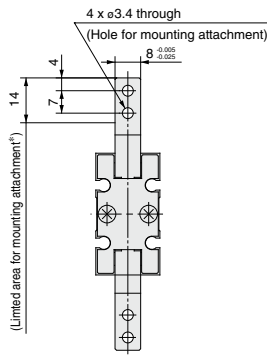

* Do not extend the attachment from limited area for mounting to avoid interference with the attachment or main body.

MHY2-20D

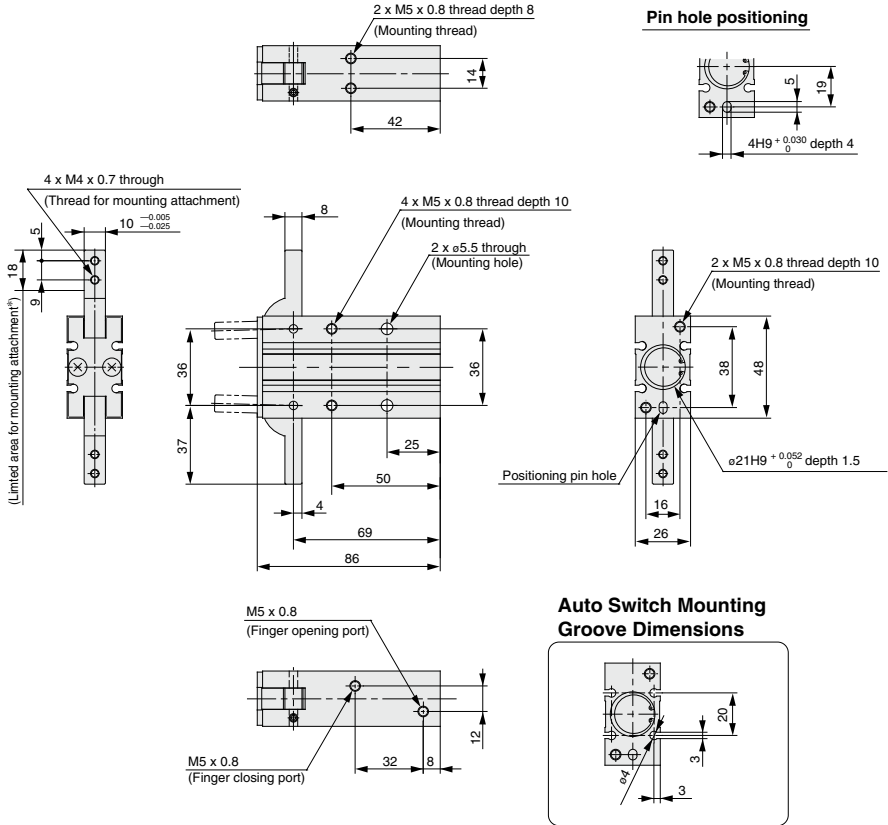

MHY2-20D2 Opening/Closing direction through-hole type

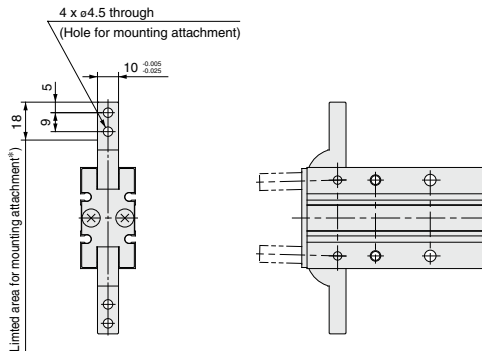

* Do not extend the attachment from limited area for mounting to avoid interference with the attachment or main body.

MHY2 Series

Dimensions

MHY2-25D

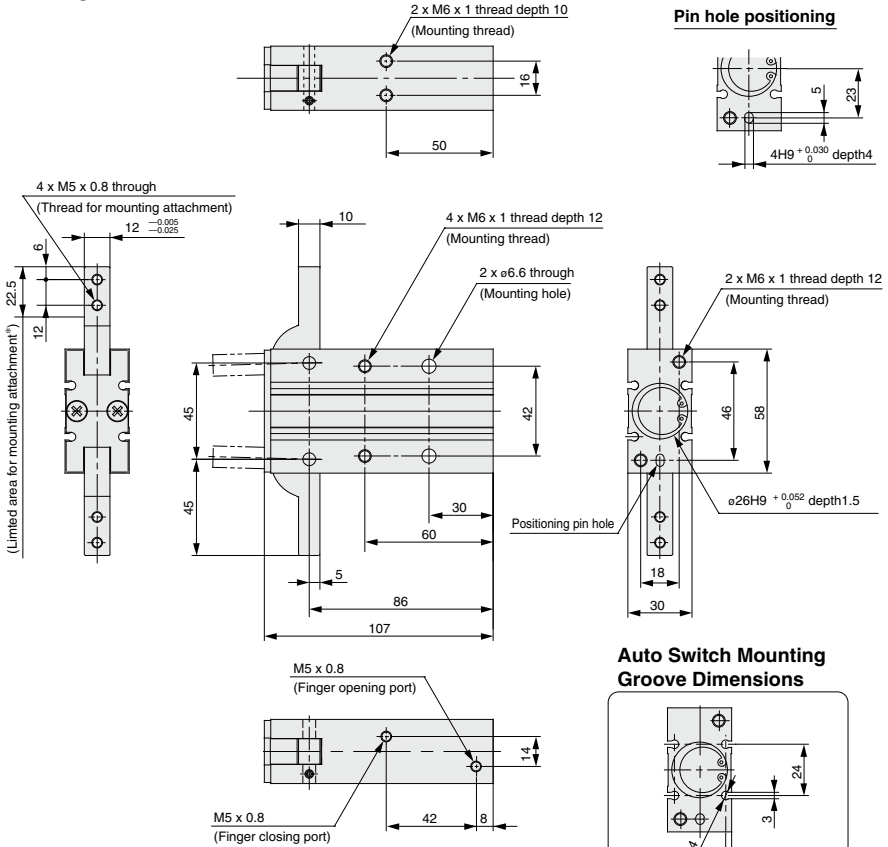

MHY2-25D2 Opening/Closing direction through-hole type

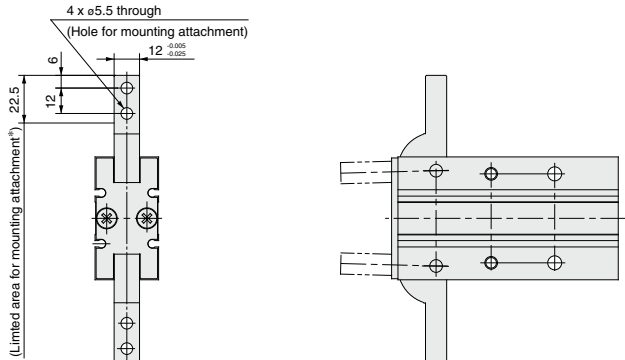

* Do not extend the attachment from limited area for mounting to avoid interference with the attachment or main body.

180° Angular Type Air Gripper Rack & Pinion Type

MHW2 Series

∅20, ∅25, ∅32, ∅40, ∅50

How to Order

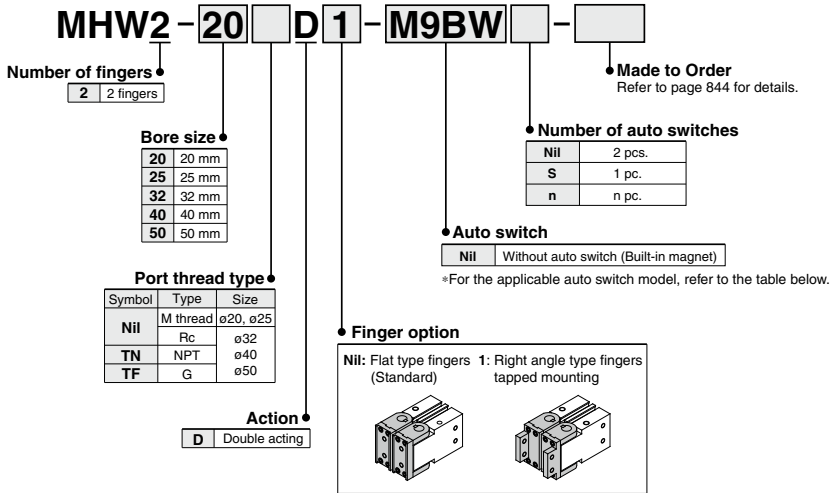

Applicable Auto Switches / Refer to pages 929 to 983 for further information on auto switches.

Type	Special function	Electrical entry	Indicator light	Wiring (Output)	Load voltage		Auto switch model		Lead wire length (m)*				Pre-wired connector	Applicable load
					DC	AC	Electrical entry direction		0.5 (Nil)	1 (M)	3 (L)	5 (Z)		
							Perpendicular	In-line						
Solid state auto switch	—	Grommet	Yes	3-wire(NPN)	5 V, 12 V	—	M9NV	M9N	●	●	●	○	○	Relay, PLC
				3-wire(PNP)			M9PV	M9P	●	●	●	○	○	
				2-wire	M9BV	M9B	●	●	●	○	○			
				3-wire(NPN)	M9NWV	M9NW	●	●	●	○	○			
	3-wire(PNP)			M9PWV	M9PW	●	●	●	○	○				
	2-wire			M9BWW	M9BW	●	●	●	○	○				
	Water resistant (2-color indicator)			3-wire(NPN)	M9NAV**	M9NA**	○	○	●	○	○			
				3-wire(PNP)	M9PAV**	M9PA**	○	○	●	○	○			
		2-wire		M9BAV**	M9BA**	○	○	●	○	○				

** Water resistant type auto switches can be mounted on the above models, but in such case SMC cannot guarantee water resistance.

* Lead wire length symbols: 0.5 m Nil (Example) M9NV
1 m M (Example) M9NWM
3 m L (Example) M9NWL
5 m Z (Example) M9NWZ

* Auto switches marked with a "○" symbol are produced upon receipt of order.

Note 1) When using the 2-color indicator type, please make the setting so that the indicator is lit in red to ensure the detection at the proper position of the air gripper.

Note 2) When ordering the air gripper with the auto switch, the auto switch mounting bracket is included.
When ordering the auto switch separately, the auto switch mounting bracket (BMG2-012) is required.

MHW2 Series

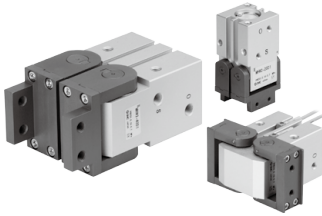

Specifications

Fluid	Air
Operating pressure	0.15 to 0.7 MPa
Ambient and fluid temperature	-10 to 60°C
Repeatability	±0.2 mm
Max. operating frequency	ø20, 25: 60 c.p.m. ø32 to 50: 30 c.p.m.
Lubrication	Not required
Action	Double acting
Auto switch (Option) ^{Note)}	Solid state auto switch (3-wire, 2-wire)

Note) Refer to pages 929 to 983 for further information on auto switches.

Symbol

Double acting: External grip

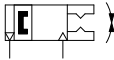

Made to Order
[Click here for details](#)

Symbol	Specifications/Description
-X4	Heat resistance
-X5	Fluororubber seal
-X50	Without magnet
-X53	EPDM for seals, Fluorine grease
-X63	Fluorine grease
-X79	Grease for food processing machines, Fluorine grease
-X79A	Grease for food processing machines

Model

Model	Bore size (mm)	Effective gripping force (N·m)	Opening angle (Both sides)		Weight ⁽²⁾ (g)
			Opening	Closing	
MHW2-20D	20	0.30	180°	-5°	300
MHW2-20D1					320
MHW2-25D	25	0.73		-6°	510
MHW2-25D1					540
MHW2-32D	32	1.61		-5°	910
MHW2-32D1					950
MHW2-40D	40	3.70	-5°	2140	
MHW2-40D1				2270	
MHW2-50D	50	8.27	-4°	5100	
MHW2-50D1				5350	

Note 1) At the pressure of 0.5 MPa

Note 2) Except auto switch

- Refer to "How to Select the Applicable Model" on page 832
- Refer to pages 832 and 833 for the details on effective holding force and allowable overhanging distance.

⚠ Precautions

Be sure to read this before handling the products.
Refer to page 7 for safety instructions and pages 14 to 22 for air gripper and auto switch precautions.

Mounting

MHW

⚠ Warning

When using right angle finger tap mounting type, monitor the interference of the bolt with the speed controller.

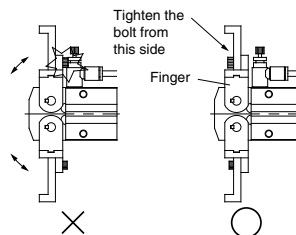

Bolt interferes with speed controller

Construction

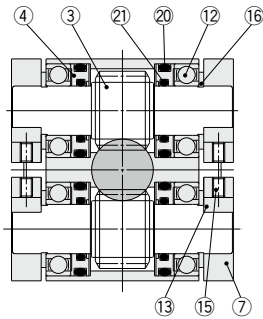

Closed condition

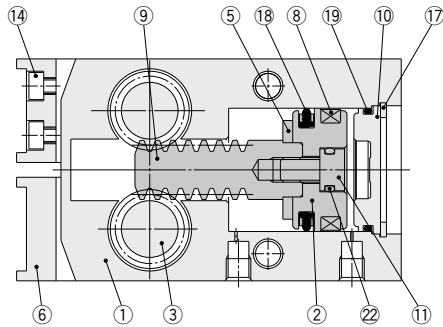

Open condition

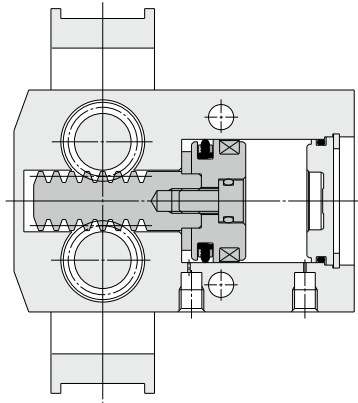

Component Parts

No.	Description	Material	Note
1	Body	Aluminum alloy	Hard anodized
2	Piston	Aluminum alloy	Hard anodized
3	Pinion gear	Carbon steel	Heat treated
4	Seal cover	Brass	
5	Bumper	Urethane rubber	
6	Finger (A)	Carbon steel	Heat treatment/Special treatment
7	Finger (B)	Carbon steel	Heat treatment/Special treatment
8	Rubber magnet	Synthetic rubber	
9	Rack	Carbon steel	Heat treatment/Special treatment

No.	Description	Material	Note
10	Cap	ø20, 25: Resin ø32 to 50: Aluminum alloy	Hard anodized
11	Piston bolt	Stainless steel	
12	Ball bearing	Carbon steel	Schield type
13	Key	Carbon steel	
14	Hexagon socket head bolt	Carbon steel	Zinc chromated
15	Hexagon socket cap screw	Carbon steel	Zinc chromated
16	Type C retaining ring for axis	Carbon steel	Phosphate coated
17	Type C retaining ring for hole	Carbon steel	Phosphate coated

Replacement Parts

Description	MHW2-20	MHW2-25	MHW2-32	MHW2-40	MHW2-50	Main parts	
Seal kit	MHW20-PS	MHW25-PS	MHW32-PS	MHW40-PS	MHW50-PS	(18)(19)(20)(21)(22)	
Piston assembly	MHW-A2001	MHW-A2501	MHW-A3201	MHW-A4001	MHW-A5001	(2)(5)(8)(9)(11)(22)	
Finger assembly	MHW2-□D	MHW-A2002	MHW-A2502	MHW-A3202	MHW-A4002	MHW-A5002	
	MHW2-□D1	MHW-A2002-1	MHW-A2502-1	MHW-A3202-1	MHW-A4002-1	MHW-A5002-1	(6)(7)(13)(14)(15)
Finger A assembly	MHW2-□D	MHW-A2006	MHW-A2506	MHW-A3206	MHW-A4006	MHW-A5006	(6)(14)
Finger C assembly	MHW2-□D1	MHW-A2006-1	MHW-A2506-1	MHW-A3206-1	MHW-A4006-1	MHW-A5006-1	(6)(14)
Finger B assembly	MHW-A2007	MHW-A2507	MHW-A3207	MHW-A4007	MHW-A5007	(7)(13)(15)	

* Please order 1 piece finger assembly per one unit.

Replacement part/grease pack part no. :

ø20, ø25, ø32 : GR-S-010(10 g)

ø40, 50 : GR-S-020(20 g)

MHW2 Series

Dimensions

MHW2-20D

Flat finger type (Standard)

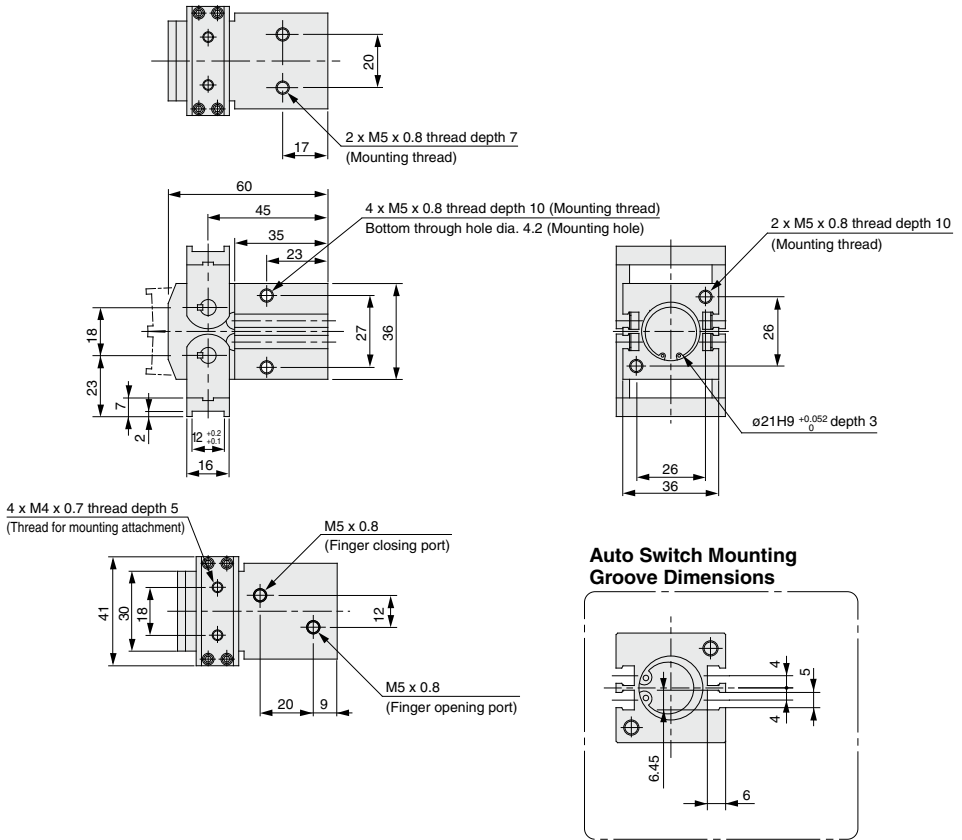

MHW2-20D1

Right angle finger type

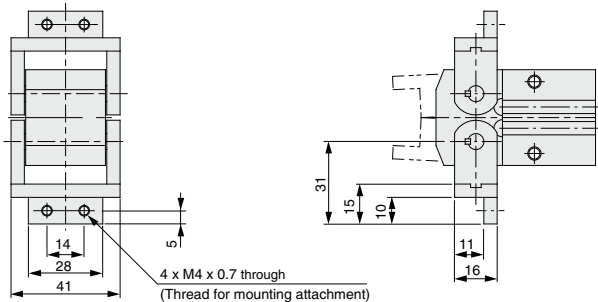

Dimensions

MHW2-25D

Flat finger type (Standard)

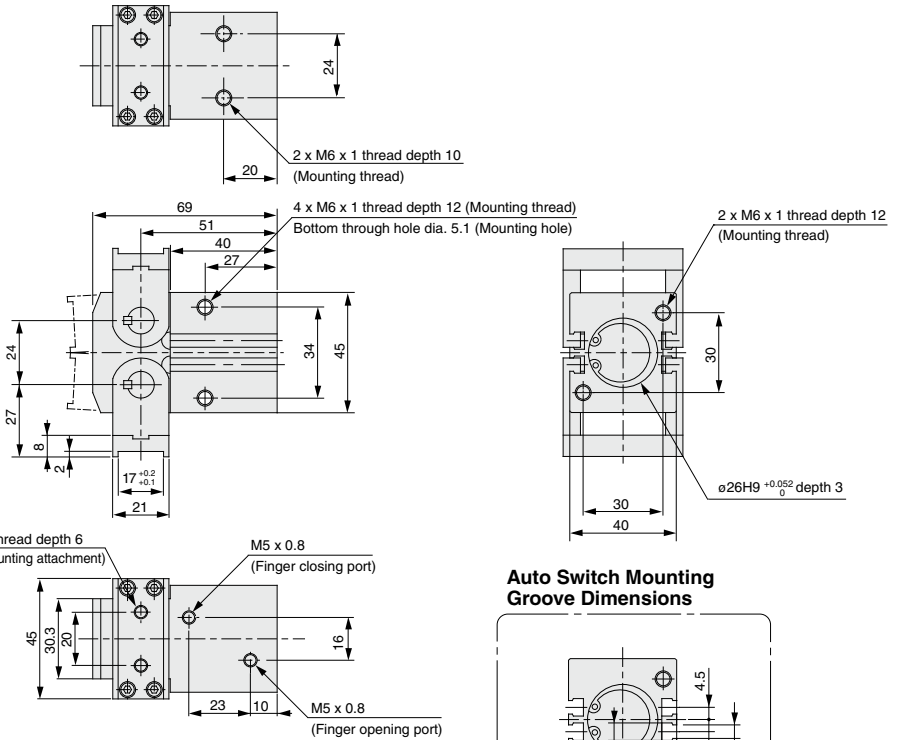

MHW2-25D1

Right angle finger type

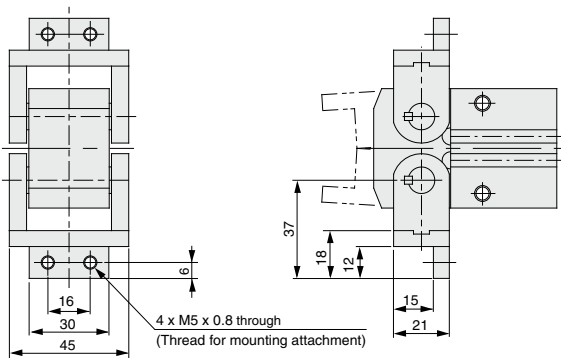

MHW2 Series

Dimensions

MHW2-32D

Flat finger type (Standard)

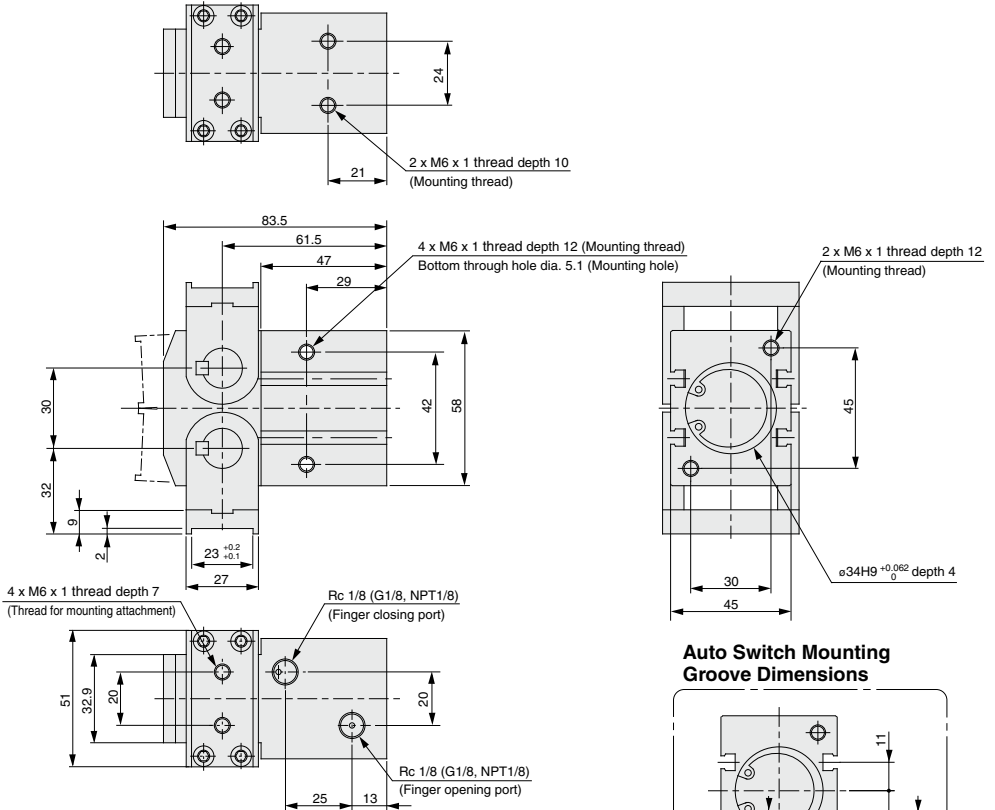

Auto Switch Mounting Groove Dimensions

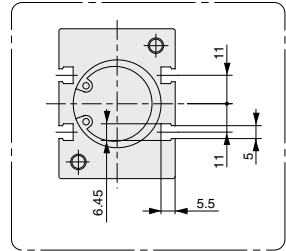

MHW2-32D1

Right angle finger type

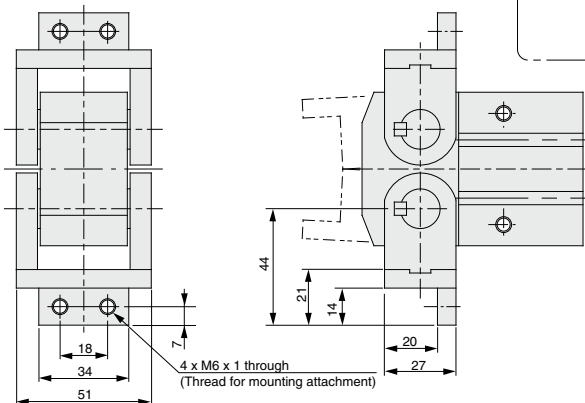

Dimensions

MHW2-40D

Flat finger type (Standard)

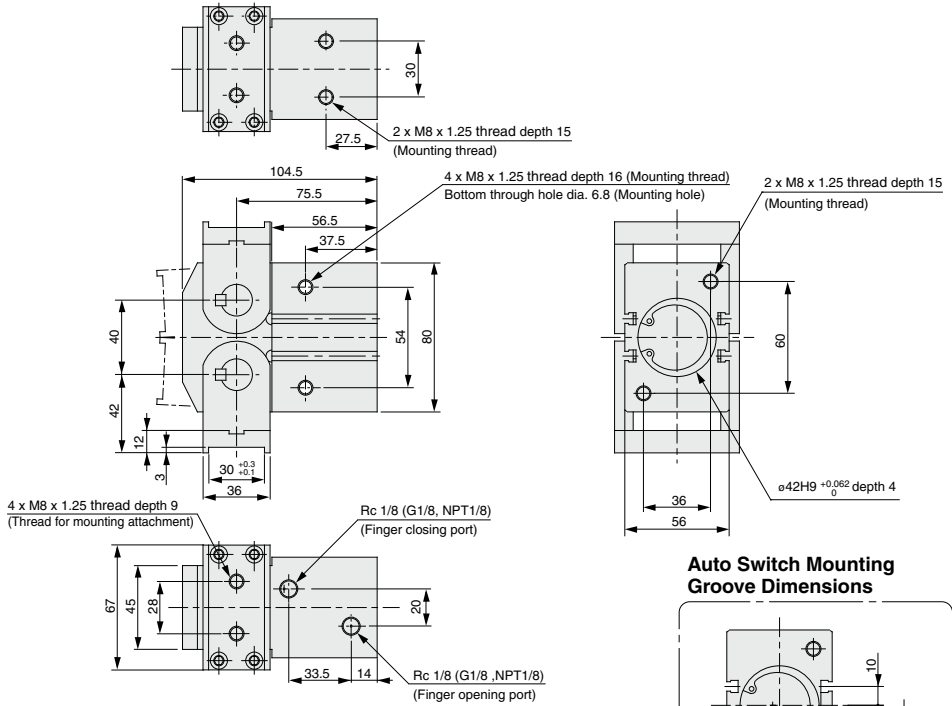

MHW2-40D1

Right angle finger type

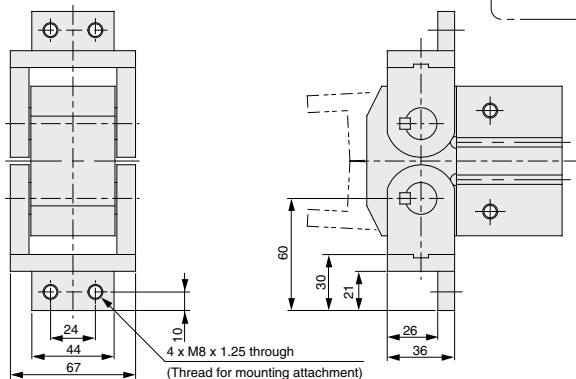

MHW2 Series

Dimensions

MHW2-50D

Flat finger type (Standard)

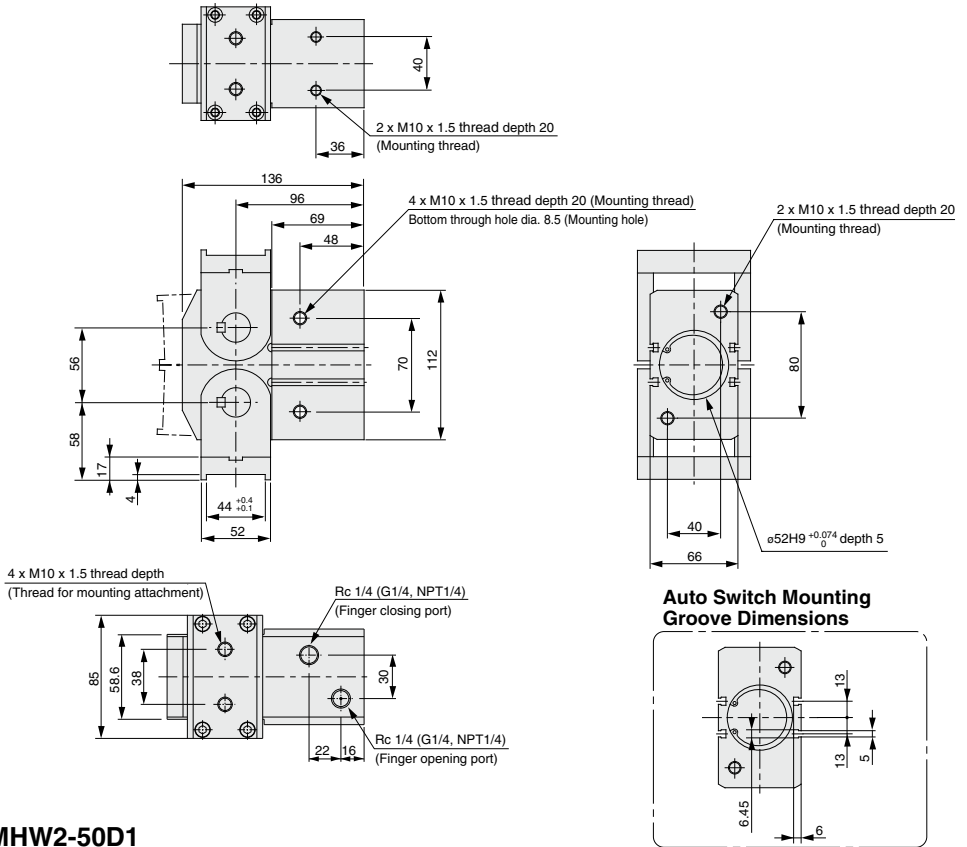

MHW2-50D1

Right angle finger type

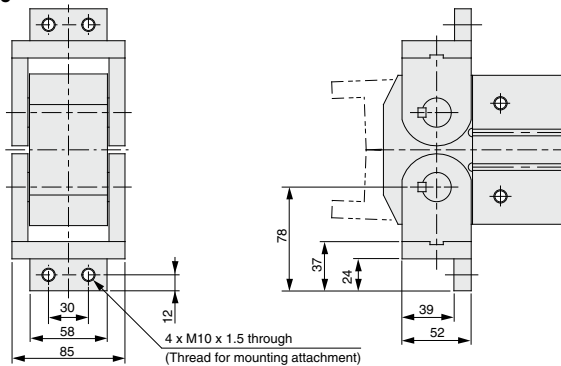





MHY2/MHW2 Series

Auto Switch Installation Examples and Mounting Positions

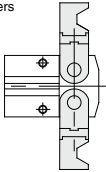
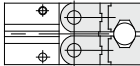
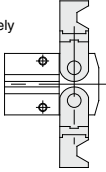
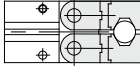
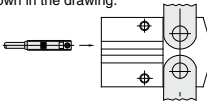
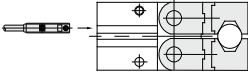
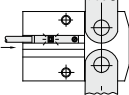
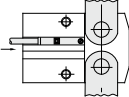
Various auto switch applications are possible through different combinations of auto switch quantities and detecting positions.

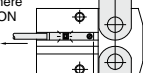
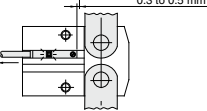
Detection when Gripping Exterior of Workpiece

Detection example	1. Confirmation of the fingers in reset position	2. Confirmation of work held
<p>Position to be detected</p>	<p>Position of fingers fully opened</p> 	<p>Position when gripping a workpiece</p> 
<p>Operation of auto switch</p>	<p>Auto Switch turned ON when fingers return. (Light ON)</p>	<p>Auto Switch turned ON when gripping a workpiece. (Light ON)</p>
<p>How to determine auto switch installation position</p> <p>At no pressure or low pressure, connect the auto switch to a power supply, and follow the directions.</p>	<p>Step 1) Completely open the fingers.</p> 	<p>Step 1) Position fingers for gripping a workpiece.</p> 
	<p>Step 2) Insert the auto switch into the switch groove in the direction shown in the drawing.</p> 	<p>Step 2) Insert the auto switch into the switch groove in the direction shown in the drawing.</p> 
	<p>Step 3) Slide the auto switch in the direction of the arrow until the indicator light illuminates.</p> 	<p>Step 3) Slide the auto switch in the direction of the arrow until the indicator light illuminates. Move the switch an additional 0.3 to 0.5 mm in the direction of the arrow and fasten it.</p>
	<p>Step 4) Slide the auto switch further in the direction of the arrow until the indicator light goes out.</p> 	<p>Position where light turns ON</p> 
	<p>Step 5) Move the auto switch in the opposite direction and fasten it at a position 0.3 to 0.5 mm beyond the position where the indicator light illuminates.</p> <p>Position where light turns ON</p>  <p>Position to be secured</p> 	<p>Position to be secured</p>  <p>0.3 to 0.5 mm</p>

MHY2 Series

Auto Switch Mounting

To set the auto switch, insert the auto switch into the installation groove of the gripper from the direction indicated in the following drawing. After setting the position, tighten the attached auto switch mounting set screw with a flat head watchmaker's screwdriver.

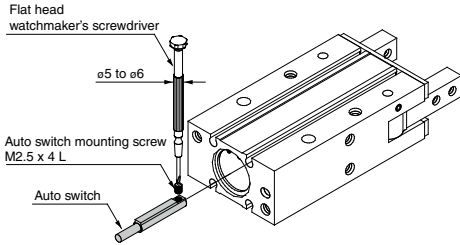

Note) Use a watchmaker's screwdriver with a grip diameter of 5 to 6 mm to tighten the auto switch mounting screw.
Also, tighten with a torque of about 0.05 to 0.15 N·m, or about 0.05 to 0.10 N·m for D-M9□A(V).

* Refer to the page 936 for the details on "Auto Switches Connection and Example".

Auto Switch Hysteresis

Auto switches have hysteresis similar to micro switches. Use the table below as a guide when adjusting auto switch positions, etc.

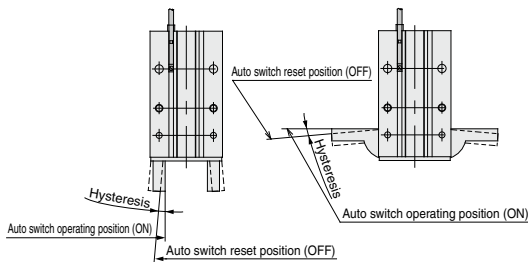

		D-M9□(V) D-M9□W(V)/M9A(V)
MHY2	Finger fully closed	2°
-10D	Finger fully open	4°
MHY2	Finger fully closed	2°
-16D	Finger fully open	3°
MHY2	Finger fully closed	2°
-20D	Finger fully open	3°
MHY2	Finger fully closed	1°
-25D	Finger fully open	2°

Protrusion of Auto Switch from Edge of Body

The projection of an auto switch from the edge of the body is shown in the table below. Use the table as a guideline for mounting.

Note) 2-color indicator type and perpendicular entry type protrude in the direction of the lead wire entry.

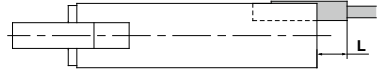

When auto switch D-M9□ is used

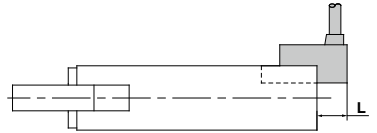

When auto switch D-M9□V is used

Max. Protrusion of Auto Switch from Edge of Body (L)

(mm)

Air gripper model	Auto switch model	Protrusion			
		In-line		Perpendicular	
		D-M9□ D-M9□W	D-M9□V D-M9□WV	D-M9□A	D-M9□AV
MHY2-10D	Open	—	—	—	—
	Closed	3	1	5	3
MHY2-16D	Open	—	—	—	—
	Closed	3	1	5	3
MHY2-20D	Open	—	—	—	—
	Closed	—	—	3	1
MHY2-25D	Open	—	—	—	—
	Closed	—	—	1	—

Auto Switch Mounting

- (1) Insert the auto switch bracket into the installation groove of the gripper as shown below and roughly set it.
- (2) Insert the auto switch into the auto switch bracket installation groove.
- (3) After confirming the detecting position, tighten the set screws (M2.5) attached to the auto switch and set it.
- (4) Be sure to change the detecting position in the state of (2).

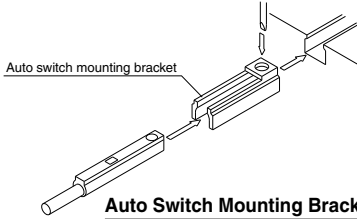

Auto Switch Mounting Bracket: Part No.

Auto switch part no.	Auto switch mounting bracket part no.
D-M9□(V)/M9□W(V)/M9□A(V)	BMG2-012

Note) Use a screwdriver with a grip diameter of 5 to 6 mm to tighten the set screws (M2.5). The tightening torque should be 0.5 to 1 N·m. As a rule, it should be turned about 90° beyond the point at which tightening can be felt.

Auto Switch Hysteresis

Auto switches have hysteresis similar to micro switches. Use the table below as a guide when adjusting auto switch positions, etc.

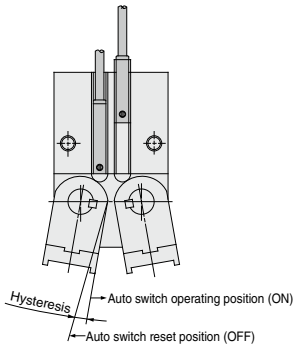

Auto switch model	Max. hysteresis (Max. value)
MHW2-20D	4°
MHW2-25D	4°
MHW2-32D	2°
MHW2-40D	2°
MHW2-50D	2°

Handling of Mounting Brackets

When auto switch is set on mounting side as shown below, allow at least 2 mm run off space on mounting late since the auto switch is protruded from the gripper edge.

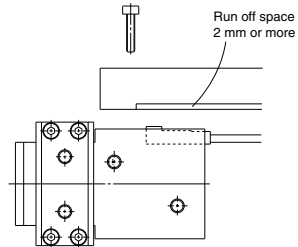

Protrusion of Auto Switch from Edge of Body

The maximum protrusion of an auto switch (when fingers are fully closed) from the edge of the body is shown in the table below. Use the table as a guideline for mounting.

When auto switches D-M9□/M9□W D-M9□A are used

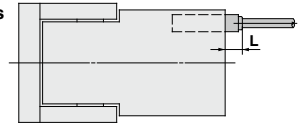

When auto switches D-M9□V/M9□WV D-M9□AV are used

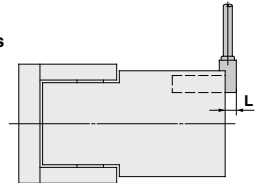

Max. Protrusion of Auto Switch from Edge of Body (L)

Air gripper model	Auto switch model Finger position	Protrusion (mm)			
		In-line electrical entry type		Perpendicular electrical entry type	
		D-M9□/M9□W	M9□A	D-M9□V/M9□WV	M9□AV
MHW2-20D	Open	—	—	—	—
	Closed	7	9	5	7
MHW2-25D	Open	—	—	—	—
	Closed	7	9	5	7
MHW2-32D	Open	—	—	—	—
	Closed	4	6	2	4
MHW2-40D	Open	—	—	—	—
	Closed	3	5	1	3
MHW2-50D	Open	—	—	—	—
	Closed	1	3	—	1



MHY2/MHW2 Series Specific Product Precautions 1

Be sure to read this before handling the products. Refer to page 7 for safety instructions and pages 14 to 22 for air gripper and auto switch precautions.

Mounting Air Grippers/MHY2 Series

Possible to mount from 3 directions.

Axial Mounting (Body Tapped)

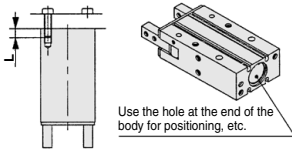

Model	Applicable bolts	Max. tightening torque (N·m)	Max. screw-in depth (Lmm)
MHY2-10D	M3 x 0.5	0.88	6
MHY2-16D	M4 x 0.7	2.1	8
MHY2-20D	M5 x 0.8	4.3	10
MHY2-25D	M6 x 1	7.4	12

Model	Bore(mm)	Hole depth (mm)
MHY2-10D	φ11H9 ^{+0.043} ₀	1.5
MHY2-16D	φ17H9 ^{+0.043} ₀	1.5
MHY2-20D	φ21H9 ^{+0.052} ₀	1.5
MHY2-25D	φ26H9 ^{+0.052} ₀	1.5

Lateral mounting (Body Tapped, Body through-hole)

●Body tapped

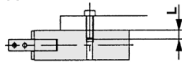

Model	Applicable bolts	Max. tightening torque (N·m)	Max. screw-in depth (Lmm)
MHY2-10D	M3 x 0.5	0.88	6
MHY2-16D	M4 x 0.7	2.1	8
MHY2-20D	M5 x 0.8	4.3	10
MHY2-25D	M6 x 1	7.4	12

●Body through-hole

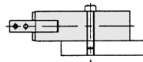

Model	Applicable bolts	Max. tightening torque (N·m)
MHY2-10D	M3 x 0.5	0.88
MHY2-16D	M4 x 0.7	2.1
MHY2-20D	M5 x 0.8	4.3
MHY2-25D	M6 x 1	7.4

Vertical Mounting (Body Tapped)

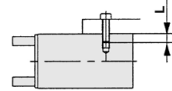

Model	Applicable bolts	Max. tightening torque (N·m)	Max. screw-in depth (Lmm)
MHY2-10D	M3 x 0.5	0.59	4
MHY2-16D	M4 x 0.7	1.3	5
MHY2-20D	M5 x 0.8	3.3	8
MHY2-25D	M6 x 1	5.9	10

How to Mount the Attachment to the Finger

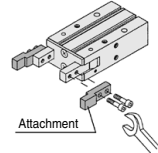

- (1) To mount the attachment to the finger, make sure to use a wrench to support the attachment so as not to apply undue strain on the finger.
- (2) Refer to the table below for the proper tightening torque on the bolt used for securing the attachment to the finger.

Model	Applicable bolts	Max. tightening torque (N·m)
MHY2-10D	M3 x 0.5	0.59
MHY2-16D	M4 x 0.7	1.4
MHY2-20D	M5 x 0.8	2.8

Operating Environment/ MHY2 Series

! Caution

Use caution for the anti-corrosiveness of finger guide section.

Martensitic stainless steel is used for the finger. However, be aware that its anti-corrosion performance is inferior to austenitic stainless steel. In particular, the finger might be rusted in an environment where water droplets are adhered to it due to dew condensation.



MHY2/MHW2 Series Specific Product Precautions 2

Be sure to read this before handling the products. Refer to page 7 for safety instructions and pages 14 to 22 for air gripper and auto switch precautions.

Mounting Air Grippers/MHW2 Series

Possible to mount from 3 directions.

Axial Mounting (Body Tapped)

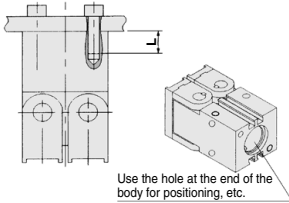

Model	Applicable bolts	Max. tightening torque (N·m)	Max. screw-in depth (Lmm)
MHW2-20D	M5 x 0.8	4.3	10
MHW2-25D	M6 x 1	7.4	12
MHW2-32D	M6 x 1	7.4	12
MHW2-40D	M8 x 1.25	17.7	15
MHW2-50D	M10 x 1.5	37.2	20

Model	Bore(mm)	Hole depth (mm)
MHW2-20D	ø21H9 ^{+0.052} ₀	3
MHW2-25D	ø26H9 ^{+0.052} ₀	3
MHW2-32D	ø34H9 ^{+0.052} ₀	4
MHW2-40D	ø42H9 ^{+0.052} ₀	4
MHW2-50D	ø52H9 ^{+0.074} ₀	5

Lateral mounting (Body Tapped, Body through-hole)

●Body tapped

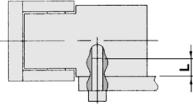

Model	Applicable bolts	Max. tightening torque (N·m)	Max. screw-in depth (Lmm)
MHW2-20D	M5 x 0.8	4.3	10
MHW2-25D	M6 x 1	7.4	12
MHW2-32D	M6 x 1	7.4	12
MHW2-40D	M8 x 1.25	17.7	16
MHW2-50D	M10 x 1.5	37.2	20

●Body through-hole

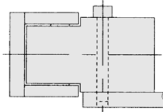

Model	Applicable bolts	Max. tightening torque (N·m)
MHW2-20D	M4 x 0.7	2.1
MHW2-25D	M5 x 0.8	4.3
MHW2-32D	M5 x 0.8	4.3
MHW2-40D	M6 x 1	7.4
MHW2-50D	M8 x 1.25	17.7

Vertical Mounting (Body Tapped)

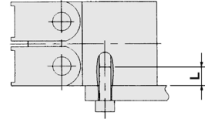

Model	Applicable bolts	Max. tightening torque (N·m)	Max. screw-in depth (Lmm)
MHW2-20D	M5 x 0.8	2.9	7
MHW2-25D	M6 x 1	5.9	10
MHW2-32D	M6 x 1	5.9	10
MHW2-40D	M8 x 1.25	17.7	15
MHW2-50D	M10 x 1.5	37.2	20

How to Mount the Attachment to the Finger

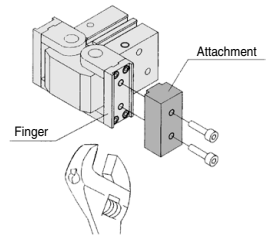

- (1) To mount the attachment to the finger, make sure to use a wrench to support the attachment so as not to apply undue strain on the finger.
- (2) Refer to the table below for the proper tightening torque on the bolt used for securing the attachment to the finger.

Model	Applicable bolts	Max. tightening torque (N·m)
MHW2-20D	M4 x 0.7	1.4
MHW2-25D	M5 x 0.8	2.5
MHW2-32D	M6 x 1	4.1
MHW2-40D	M8 x 1.25	10.6
MHW2-50D	M10 x 1.5	24.5