

5 Port Solenoid Valve

VQC1000/2000 Series

The EX250/500 series is to be discontinued. When designing new equipment and facilities, consider using another series (EX260/EX600) instead.

Metal Seal

Rubber Seal

Connector Type Manifold

Power saving

IP67 enclosure compatible



Standard: **0.4 w**

(Reduced by **60%** compared to current model)

High-pressure (1 MPa, Metal seal): **0.95 w**



Connector Type Manifold

VQC1000/2000 Series

Power saving

Standard: **0.4 W** (Reduced by **60%** compared to current model)

High-pressure (1 MPa, Metal seal): **0.95 W**

IP67 enclosure compatible

Dust-tight, Immersion-proof

(Based on IEC60529) (S/T/L/M kit)

Applicable to EX600 (Input/Output) serial transmission system (Fieldbus system)

- Available for DeviceNet®, PROFIBUS DP, CC-Link, EtherNet/IP™, EtherCAT and PROFINET Fieldbus protocols
- EtherNet/IP™ and PROFINET are compatible with wireless systems.

- **Max. 9 units** ^{Note)} can be connected in any order.

The unit to connect input device such as an auto switch, pressure switch and flow switch, and the unit to connect output device such as a solenoid valve, relay and indicator light can be connected in any order.

Note) Except SI unit

- **Analog unit can be connected with analog input device or analog output device.**

As well as a Digital (switch) Input/Output Unit, a unit applicable to analog signal is provided, and can be connected with various device for control.

- **Self-diagnosis function**

It is possible to ascertain the maintenance period and identify the parts that require maintenance, by an input (sensor) open circuit detecting function and an input/output signal of ON/OFF counter function. Also, the monitoring of input/output signal and the setting of parameters can be performed with a Handheld Terminal.

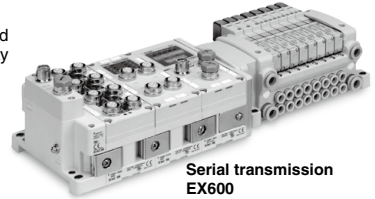

Serial transmission
EX600

The EX260 series supports safety communication (PROFIsafe).

- **This is a Fieldbus unit which supports safety standard ISO 13849-compliant safety circuit constructions.**



PROFIsafe is established as an international standard (IEC 61784-3-3). It is a communication protocol that transmits safety-related data by PROFINET communication and can be used up until safety standards ISO 13849-1 PL e and IEC 61508/IEC 62061 SIL 3.

- **Using the safety communication protocol**

Refer to the EX260 **Web Catalog** for details on units that support the safety communication protocol.

When using a manifold valve within an ISO 13849-compliant safety system, the device needs to be considered from both the pneumatic circuit and the electric side.

Devices (including valves) need to be selected based on whether their functions are in line with the safety level of the equipment as a whole.

The use of valves that have been validated as being compliant with ISO 13849-2 may be required.

For details on valves that have been validated, please contact SMC.

In addition, refer to "Safety Instructions" for precautions on model selection.

Compact and high flow

Series	Manifold pitch (mm)	Flow rate characteristics <small>Note)</small>						Applicable cylinder bore size (mm)
		Metal seal			Rubber seal			
		C [dm ³ /(s·bar)]	b	Cv	C [dm ³ /(s·bar)]	b	Cv	
VQC1000	10.5	0.72	0.25	0.18	1.0	0.30	0.25	Up to ø50
VQC2000	16	2.6	0.15	0.60	3.2	0.30	0.80	Up to ø80

Note) Flow rate characteristics: 2-position single, 4/2 → 5/3 (A/B → R1/R2)

Connector entry direction can be changed with a single push. (F/P kit)

The connector entry direction can be changed from the top to the side by simply pressing the manual release button.

It is not necessary to use the manual release button when switching from the side to the top.

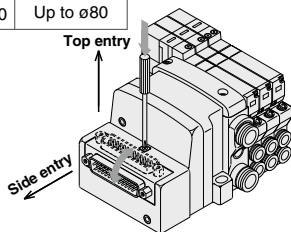

A wide variety of prepackaged wiring configurations

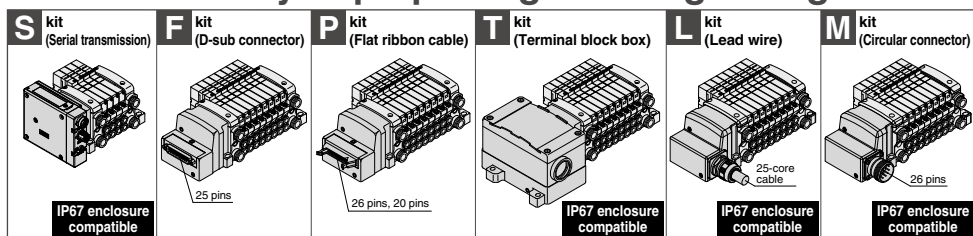

- Our six standard wiring packages bring a world of ease to wiring and maintenance work, while the protective enclosures of four of them conform to IP67 standards.
- The S kit is compatible with a combined I/O unit. (Not applicable to Gateway unit)

Connector type manifold

- The use of multi-pin connectors to replace wiring inside manifold blocks provides flexibility when adding stations or changing manifold configuration.
- All kits use multi-pin connectors, so switching from the F kit (D-sub connector) to the S kit (serial transmission) can be done simply by changing the kit section.

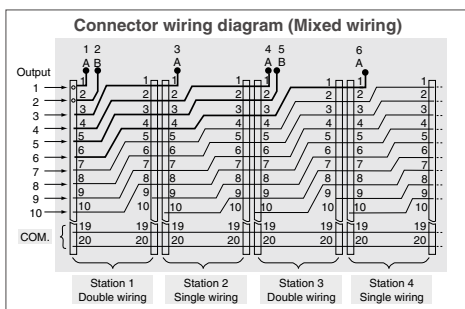
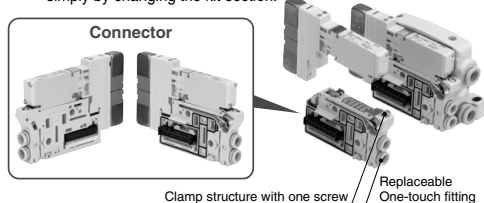

(Refer to the connector wiring diagram.)
Printed circuit board patterns between connectors are shifted at every station. This allows for viable connections to take place without necessarily specifying whether the manifold station is double, single, or mixed wiring.

Dual 3-port valves, 4 positions

VQC1000/2000 (Rubber seal only)

- Two 3-port valves built into one body
- The 3-port valves on the A and B sides can operate independently.
- When used as 3-port valves, only half the number of stations is required.
- Can also be used as a 4-position, 5-port type valve.

Exhaust center : **VQC1A01**
 : **VQC2A01**
Pressure center : **VQC1B01**
 : **VQC2B01**

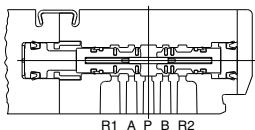

Model	Symbol
VQC1A01 VQC2A01	<p>A side: N.C. valve 4(A) B side: N.C. valve 2(B)</p> <p>5(R1) 1(P) 3(R2)</p>
VQC1B01 VQC2B01	<p>A side: N.O. valve 4(A) B side: N.O. valve 2(B)</p> <p>5(R1) 1(P) 3(R2)</p>
VQC1C01 VQC2C01	<p>A side: N.C. valve 4(A) B side: N.O. valve 2(B)</p> <p>5(R1) 1(P) 3(R2)</p>

VQC Series/Base Mounted: Variations

		Sonic conductance C [dm ² /(s·bar)] (CYL → EXH) 4/2 → 5/3		Single/Double 3-position (Closed center)		Applicable cylinder bore size		S kit					
								Serial transmission					
								Gateway-type	Integrated-type (I/O)			Integrated-type (for output)	
								EX500 <small>Compatible protocol</small> • EtherNet/IP™ • DeviceNet® • PROFINET	EX600 <small>Compatible protocol</small> • DeviceNet® • PROFIBUS DP • CC-Link • EtherNet/IP™* • PROFINET® <small>* Compatible with wireless systems</small>	EX245 <small>Compatible protocol</small> • PROFINET	EX250 <small>Compatible protocol</small> • DeviceNet® • AS-Interface • EtherNet/IP™	EX260 <small>Compatible protocol</small> • DeviceNet® • PROFIBUS DP • CC-Link • EtherCAT • PROFINET • EtherNet/IP™ • Ethernet POWERLINK • IO-Link • PROFI-safe	EX126 <small>Compatible protocol</small> • CC-Link
VQC1000 Series P. 1084	Metal seal	VQC1□00	0.72	0.72	Up to ø50	●	●	—	●	●	●		
	Rubber seal	VQC1□01	1.0	0.65		●	●	—	●	●	●		
VQC2000 Series P. 1090	Metal seal	VQC2□00	2.6	2.0	Up to ø80	●	●	●	●	●	●		
	Rubber seal	VQC2□01	3.2	2.2		●	●	●	●	●	●		

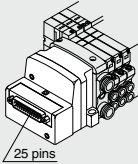
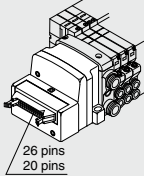
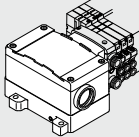
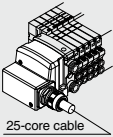
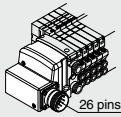
					Manifold Optional Parts P.1134	
F kit	P kit	T kit	L kit	M kit	Port size	
D-sub connector	Flat ribbon cable	Terminal block box	Electrical entry	Circular connector		
<p>D-sub connector</p> <p>(Conforming to MIL D-sub connector)</p>  <p>25 pins</p>	<p>Flat ribbon cable</p> <p>(Conforming to MIL flat ribbon cable connector)</p>  <p>26 pins 20 pins</p>	<p>Terminal block box (Terminal block)</p> <p>(Terminal block is compactly arranged on one side.)</p>  <p>IP67 compliant</p>	<p>Lead wire</p> <p>(IP67 enclosure with use of multiple wire cable with sheath and waterproof connector)</p>  <p>25-core cable</p> <p>IP67 compliant</p>	<p>Circular connector</p> <p>(IP67 enclosure with use of waterproof circular connector)</p>  <p>26 pins</p> <p>IP67 compliant</p>		
					SUP EXH port	Cylinder port
					1, 3 (P, R)	2, 4 (A, B)
					C8 (ø8)	C3 (ø3.2) C4 (ø4) C6 (ø6) M5 (M5 thread)
					N9 (ø5/16")	N1 (ø1/8") N3 (ø5/32") N7 (ø1/4")
					C10 (ø10)	C4 (ø4) C6 (ø6) C8 (ø8)
					N11 (ø3/8")	N3 (ø5/32") N7 (ø1/4") N9 (ø5/16")
					In case of branch type	
					C12 (ø12)	
					N13 (ø1/2")	

VQC1000/2000 Series

Cylinder Speed Chart

This chart is provided as guidelines only.
For performance under various conditions, use SMC's Model Selection Program before making a judgment.

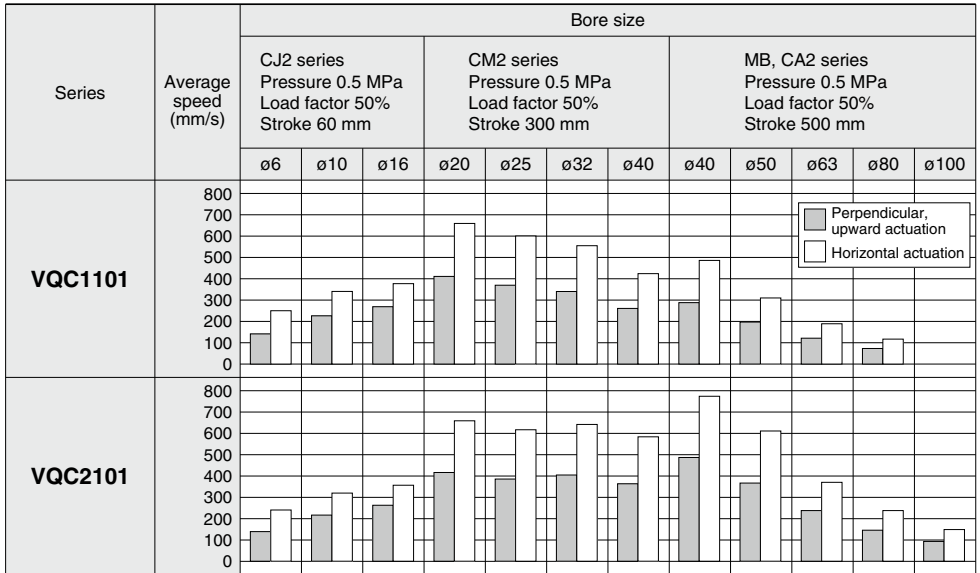

* It is when the cylinder is extending that is meter-out controlled by speed controller which is directly connected with cylinder, and its needle valve with being fully open.

* The average velocity of the cylinder is what the stroke is divided by the total stroke time.

* Load factor: $((\text{Load mass} \times 9.8) / \text{Theoretical force}) \times 100\%$

Conditions

Series	Conditions	CJ2 series	CM2 series	MB, CA2 series
VQC1101	Tube x Length	T0604 (O.D. ø6/I.D. ø4) x 1 m		
	Speed controller	AS3002F-06		
	Silencer	AN15-C08		
VQC2101	Tube x Length	T0806 (O.D. ø8/I.D. ø6) x 1 m		
	Speed controller	AS3002F-08		
	Silencer	AN20-C10		

INDEX

Features	P.1078
Variations	P.1080
Cylinder Speed Chart	P.1082
VQC1000 How to Order, Manifold Options.....	P.1084
VQC2000 How to Order, Manifold Options.....	P.1090
VQC1000/2000 Model, Standard/Manifold Specifications.....	P.1100
VQC1000/2000 S kit (Serial transmission) EX500 Gateway Decentralized System 2 (128 points)	P.1102
VQC1000/2000 S kit (Serial transmission) EX600	P.1106
VQC2000 S kit (Serial transmission) EX245	P.1110
VQC1000/2000 S kit (Serial transmission) EX250	P.1111
VQC1000/2000 S kit (Serial transmission) EX260	P.1112
VQC1000/2000 S kit (Serial transmission) EX126	P.1115
VQC1000/2000 F kit (D-sub connector)	P.1118
VQC1000/2000 P kit (Flat ribbon cable)	P.1120
VQC1000/2000 T kit (Terminal block box)	P.1122
VQC1000/2000 L kit (Lead wire)	P.1124
VQC1000/2000 M kit (Circular connector)	P.1126
VQC1000/2000 Construction	P.1128
VQC1000/2000 Exploded View of Manifold.....	P.1130
VQC1000/2000 Manifold Optional Parts.....	P.1134
VQC1000/2000 Specific Product Precautions	P.1141

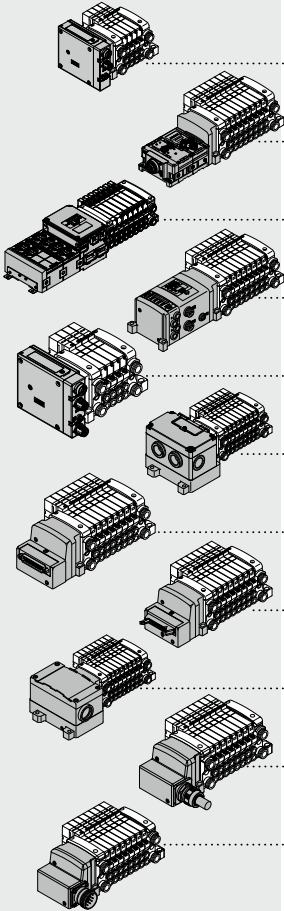

The EX250/500 series is to be discontinued. When designing new equipment and facilities, consider using another series (EX260/EX600) instead.



Base Mounted Plug-in Unit VQC1000 Series

Refer to page 1098 for details on manifolds that support safety communication (PROFISafe).

How to Order Manifold

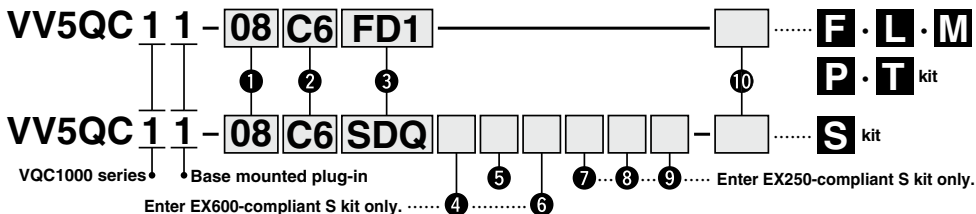

1 Valve stations

01	1 station
⋮	⋮

The maximum number of stations differs depending on the electrical entry. (Refer to 1 Kit type/Electrical entry/Cable length.)

Note) In case of compatibility with the S kit/AS-Interface, the maximum number of solenoids is as shown below, so please be careful of the number of stations.
 • 8 in/8 out: Maximum 8 solenoids
 • 4 in/4 out: Maximum 4 solenoids

2 Cylinder port size

C3	With ø3.2 One-touch fitting
C4	With ø4 One-touch fitting
C6	With ø6 One-touch fitting
M5	M5 thread
CM	Mixed sizes and with port plug
L3	Top ported elbow with ø3.2 One-touch fitting
L4	Top ported elbow with ø4 One-touch fitting
L6	Top ported elbow with ø6 One-touch fitting
L5	M5 thread
B3	Bottom ported elbow with ø3.2 One-touch fitting
B4	Bottom ported elbow with ø4 One-touch fitting
B6	Bottom ported elbow with ø6 One-touch fitting
B5	M5 thread
LM	Elbow port, mixed sizes (including upward, downward piping and mixed)
MM Note 2)	Mixed size for different types of piping, option installed

Note 1) Indicate the size by means of the manifold specification sheet in case of "CM", "LM", "NM".
 Note 2) When selecting the mixed size for different types of piping or dual flow fitting assembly, enter "MM" and give instructions in the manifold specification sheet.
 Note 3) Symbols for inch sizes are as follows:

- N1: ø1/8" • N3: ø5/32"
 - N7: ø1/4" • NM: Mixed
- The top ported elbow is LN□ and the bottom ported elbow is BN□.

5 SI unit output polarity

SI unit output polarity	EX250 integrated-type (I/O) serial transmission system		
	DeviceNet®	AS-Interface	EtherNet/IP™
NH Positive common	—	—	—
N Negative common	○	○	○

SI unit output polarity	EX500 Gateway Decentralized System 2 (128 points)	EX260 integrated-type (for output) serial transmission system						EX126 integrated-type (for output) serial transmission system		
		DeviceNet	PROFIBUS DP	CC-Link	EtherCAT	PROFINET	EtherNet/IP™	Ethernet POWERLINK	IO-Link	CC-Link
NH Positive common	—	○	○	○	○	○	○	—	—	—
N Negative common	—	○	○	○	○	○	○	—	—	—

SI unit output polarity	EX600 integrated-type (I/O) serial transmission system (Fieldbus system)							
	DeviceNet®	PROFIBUS DP	CC-Link	EtherNet/IP™	PROFINET	EtherNet/IP™ compatible wireless base	PROFINET compatible wireless base	Wireless remote
NH Positive common	○	○	○	○	○	○*2	○	○
N Negative common	○	○	○	○	○	○	○	○

*1 Select "Nil" for without SI unit (SD0□).

*2 Only negative common is available for PROFINET (OPC UA).

4 End plate type (Enter EX600-compliant S kit only.)

Nil	Without end plate
2	M12 power supply connector, B-coded
3	7/8 inch power supply connector
4	M12 power supply connector IN/OUT, A-coded, Pin arrangement 1
5	M12 power supply connector IN/OUT, A-coded, Pin arrangement 2

Note) Without SI unit, the symbol is nil.
 * The pin layout for "4" and "5" pin connector is different.

6 I/O unit stations (Enter EX600-compliant S kit only.)

Nil	None
1	1 station
⋮	⋮
9	9 stations

Note 1) Without SI unit, the symbol is nil.
 Note 2) SI unit is not included in I/O unit stations.
 Note 3) When I/O unit is selected, it is shipped separately, and assembled by customer. Refer to the attached operation manual for mounting method.

7 Number of input blocks (Enter EX250-compliant S kit only.)

Nil	Without SI unit/input block (SD0)
0	Without input block
1	With 1 input block
⋮	⋮
8	With 8 input blocks

Note) For the S kit compatible with AS-Interface, the maximum number of stations is limited. Refer to page 1364 for details.

8 Input block type (Enter EX250-compliant S kit only.)

Nil	Without input block
1	M12, 2 inputs
2	M12, 4 inputs
3	M8, 4 inputs (3 pins)

9 Input block specification (Enter EX250-compliant S kit only.)

Nil	PNP sensor input or without input block
N	NPN sensor input

10 Option

Nil	None
B Note 2)	All stations with back pressure check valve
D	With DIN rail (Rail length: Standard) Note 7)
D□ Note 9)	With DIN rail (Rail length: Special) Note 7)
K Note 4)	Special wiring spec. (Except double wiring)
N Note 10)	With name plate
R Note 5)	External pilot
S Note 6)	Direct EXH outlet with built-in silencer

Note 1) When two or more symbols are specified, indicate them alphabetically. Example - BRS
 Note 2) When a back pressure check valve is desired, and is to be installed only in certain manifold stations, specify the mounting position by means of the manifold specification sheet.
 Note 3) For special DIN rail length, indicate "D□". (Enter the number of stations inside □.) Example - D08
 In this case, stations will be mounted on a DIN rail for 8 stations regardless of the actual number of manifold stations.
 The specified number of stations must be larger than the number of stations on the manifold. Indicate "D0" for the option without DIN rail.
 Note 4) When single wiring and double wiring are mixed, specify wiring type of each station by means of the manifold specification sheet.
 Note 5) For external pilot option, "-R", indicate the external pilot specification "R" for the applicable valves as well.
 Note 6) Built-in silencer type does not satisfy IP67.
 Note 7) When "Without SI unit (SD0, SD60)" is specified, "With DIN rail (D)" cannot be selected.
 Note 8) When changing the specifications of the EX600 from no DIN rail to DIN rail mounting, please consult SMC.
 Note 9) DIN rail is not attached (but shipped together) on the manifold in case of the EX600 with DIN rail. Refer to back page 1143 for mounting method.
 Note 10) When mounting the blanking plate with connector and the slide locking manual type valve by ordering only the manifold, order the name plate separately. For details, refer to page 1135.

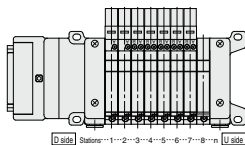

* Stations are counted from station 1 on the D-size.

Refer to the **Web Catalog** and the Operation Manual for the details of EX600 Integrated-type (For I/O) Serial Transmission System. Please download the Operation Manual via our website, <https://www.smwworld.com>

3 Kit type/Electrical entry/Cable length

* Numbers in parentheses represent the maximum number of solenoids in case of mixed single and double wiring. The maximum number of stations is determined by the total number of solenoids. When ordering mixed wiring, please add the option symbol "-K".

S kit
(Serial transmission:
EX500 gateway-type)

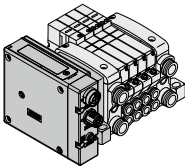

Note A separate gateway unit and communication cable are required.

IP67 compliant
SI unit: EX500

SD0	Without SI unit	—	—
SDA3	EX500 Gateway Decentralized System 2 (128 points)	32 outputs ^{Note 1)}	1 to 12 stations (24)

S kit
(Serial transmission
(Fieldbus system):
EX600 integrated-type (I/O))

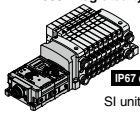

IP67 compliant
SI unit: EX600

SD60	Without SI unit		
SD6Q	DeviceNet [®]		
SD6N	PROFIBUS DP		
SD6V	CC-Link		
SD6FA	PROFINET (IO-Link unit)		1 to 12 stations
SD6FB	PROFINET (OPC UA, IO-Link unit) ^{Note 6)}		(24)
SD6EB	EtherNet/IP™ (IO-Link unit)		
SD6DA	EtherCAT (IO-Link unit)		
SD6WE	EtherNet/IP™ compatible wireless base ^{Note 5)}		
SD6WF	PROFINET compatible wireless base ^{Note 5)}		
SD6WS	Wireless remote ^{Note 5)}		

SI unit: EX250

S kit
(Serial transmission:
EX250 integrated-type (I/O))

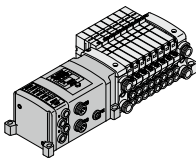

IP67 compliant

SD0	Without SI unit		1 to 12 stations
SDQ	DeviceNet [®]		(24)
SDTA	AS-Interface, 8 in/8 out, 2 power supply systems		1 to 4 stations (8)
SDTB	AS-Interface, 4 in/4 out, 2 power supply systems		1 to 2 stations (4)
SDTC	AS-Interface, 8 in/8 out, 1 power supply systems ^{Note 2)}		1 to 4 stations (8)
SDTD	AS-Interface, 4 in/4 out, 1 power supply systems ^{Note 2)}		1 to 2 stations (4)
SDZEN	EtherNet/IP™		1 to 12 stations (24)

S kit
(Serial transmission:
EX260 integrated-type (for output))

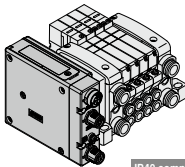

IP40 compliant
SI unit: EX260

Symbol	Protocol	Number of outputs	Communication connector		Stations
			Without SI unit		
SDQ		32			1 to 12 stations (24)
SQA	DeviceNet [®]	16	M12		1 to 8 stations (16)
SQB		32			1 to 12 stations (24)
SNA	PROFIBUS DP	16	M12		1 to 8 stations (16)
SNB		32			1 to 12 stations (24)
SNC		16			1 to 8 stations (16)
SND		32			1 to 12 stations (24)
SVA	CC-Link	16	M12	D-sub ^{Note 4)}	1 to 8 stations (16)
SVB		32			1 to 12 stations (24)
SDA	EtherCAT	16	M12		1 to 8 stations (16)
SDB		32			1 to 12 stations (24)
SFA	PROFINET	16	M12		1 to 8 stations (16)
SFB		32			1 to 12 stations (24)
SEA	EtherNet/IP™	16	M12		1 to 8 stations (16)
SEB		32			1 to 12 stations (24)
SGA	Ethernet POWERLINK	16	M12		1 to 8 stations (16)
SGB		32			1 to 12 stations (24)
SKA	IO-Link	32	M12		1 to 12 stations (24)

S kit
(Serial transmission:
EX126 integrated-type (for output))

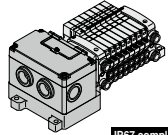

IP67 compliant
SI unit: EX126

SDVB	CC-Link		1 to 8 stations (16)
------	---------	--	----------------------

F kit
(D-sub connector)

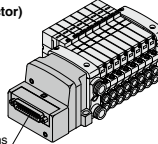

25 pins
IP40 compliant

FD0	D-sub connector (25P) without cable		
FD1	D-sub connector (25P) with 1.5 m cable		1 to 12 stations (24)
FD2	D-sub connector (25P) with 3.0 m cable		
FD3	D-sub connector (25P) with 5.0 m cable		

P kit
(Flat ribbon cable)

Note) For a 20P flat ribbon cable, the cable assembly must be ordered separately.

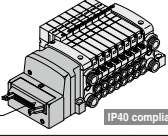

26 pins
20 pins
IP40 compliant

PDD	Flat ribbon cable (26P) without cable		
PD1	Flat ribbon cable (26P) with 1.5 m cable		1 to 12 stations (24)
PD2	Flat ribbon cable (26P) with 3.0 m cable		
PD3	Flat ribbon cable (26P) with 5.0 m cable		
PDC	Flat ribbon cable (20P) without cable		1 to 8 stations (16)

T kit
(Terminal block box)

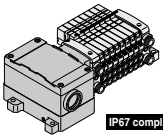

IP67 compliant

TD0	Terminal block box		1 to 10 stations (20)
-----	--------------------	--	-----------------------

L kit
(Lead wire)

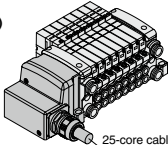

25-core cable
IP67 compliant

LD0	Lead wire (25 cores) 0.6 m lead wire		
LD1	Lead wire (25 cores) 1.5 m lead wire		1 to 12 stations (24)
LD2	Lead wire (25 cores) 3.0 m lead wire		

M kit
(Circular connector)

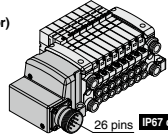

26 pins
IP67 compliant

MD0	Circular connector (26P) without cable		
MD1	Circular connector (26P) with 1.5 m cable		1 to 12 stations (24)
MD2	Circular connector (26P) with 3.0 m cable		
MD3	Circular connector (26P) with 5.0 m cable		

* The maximum number of stations displayed in parentheses is applied to the special wiring specifications. (Option "-K")
 Note 1) When using the SI unit with 32 outputs, use the GW unit compatible with the EX500 Gateway Decentralized System 2 (128 points).

Note 2) When selecting SI units with SDTC or SDTD specifications, there are limits to the supply current from the SI unit to the input block or valve. Refer to page 1364 for details.
 Note 3) When selecting SI units with SDZCN specifications only, IP40 is compatible. (All other SI units are IP67 compliant.)

Note 4) For the SI unit part no., refer to page 1086.
 Note 5) The wireless system is suitable for use only in a country where it is in accordance with the Radio Act and regulations of that country.
 Note 6) Only negative common (PNP) is available.

VQC1000 Series

SI Unit Part No.

EX500 Gateway Decentralized System 2 (128 points)

Symbol	SI unit part no.		Page
	Negative common (PNP)		
SDA3	EX500-S103		P.1131

EX600

Symbol	Compatible protocol	SI unit part no.		Page
		Positive common (NPN)	Negative common (PNP)	
SD6Q	DeviceNet®	EX600-SDN2A	EX600-SDN1A	P.1131
SD6N	PROFIBUS DP	EX600-SPR2A	EX600-SPR1A	
SD6V	CC-Link	EX600-SMJ2	EX600-SMJ1	
SD6FA	PROFINET (IO-Link unit)	EX600-SPN4	EX600-SPN3	
SD6FB	PROFINET (OPC UA, IO-Link unit)	—	EX600-SPN31	
SD6EB	EtherNet/IP™ (IO-Link unit)	EX600-SEN8	EX600-SEN7	
SD6DA	EtherCAT (IO-Link unit)	EX600-SEC4	EX600-SEC3	
SD6WE	EtherNet/IP™ compatible wireless base ^(Note)	EX600-WEN2	EX600-WEN1	
SD6WF	PROFINET compatible wireless base ^(Note)	EX600-WPN2	EX600-WPN1	
SD6WS	Wireless remote ^(Note)	EX600-WSV2	EX600-WSV1	

(Note) The wireless system is suitable for use only in a country where it is in accordance with the Radio Act and regulations of that country.

EX260

Symbol	Compatible protocol	Number of outputs	SI unit part no.		Communication connector	Page
			Positive common (NPN)	Negative common (PNP)		
SQA	DeviceNet®	32	EX260-SDN2	EX260-SDN1	M12	P.1132
SQB		16	EX260-SDN4	EX260-SDN3		
SNA	PROFIBUS DP	32	EX260-SPR2	EX260-SPR1	D-sub ^(Note)	
SNB		16	EX260-SPR4	EX260-SPR3		
SNC		32	EX260-SPR6	EX260-SPR5		
SND		16	EX260-SPR8	EX260-SPR7		
SVA	CC-Link	32	EX260-SMJ2	EX260-SMJ1	M12	
SVB		16	EX260-SMJ4	EX260-SMJ3		
SDA	EtherCAT	32	EX260-SEC2	EX260-SEC1	M12	
SDB		16	EX260-SEC4	EX260-SEC3		
SFA	PROFINET	32	EX260-SPN2	EX260-SPN1	M12	
SFB		16	EX260-SPN4	EX260-SPN3		
SEA	EtherNet/IP™	32	EX260-SEN4	EX260-SEN3	M12	
SEB		16	EX260-SEN4	EX260-SEN3		
SGB	Ethernet	32	—	EX260-SPL1	M12	
SGB	POWERLINK	16	—	EX260-SPL3		
SKA	IO-Link	32	—	EX260-SIL1	M12	

(Note) When the communication connector specification is D-sub, the enclosure is IP40. (IP67 for other specifications)

EX250

Symbol	Compatible protocol	SI unit part no.	Page
SDQ	DeviceNet®	EX250-SDN1	P.1132
SDTA	AS-Interface, 8 in/8 out, 2 power supply systems	EX250-SAS3	
SDTB	AS-Interface, 4 in/4 out, 2 power supply systems	EX250-SAS5	
SDTC	AS-Interface, 8 in/8 out, 1 power supply systems	EX250-SAS7	
SDTD	AS-Interface, 4 in/4 out, 1 power supply systems	EX250-SAS9	
SDZEN	EtherNet/IP™	EX250-SEN1	

EX126

Symbol	Compatible protocol	SI unit part no.	Page
SDVB	CC-Link	EX126D-SMJ1	P.1132

For details about the EX series (Serial transmission system), refer to the **Web Catalog** and the Operation Manual. Please download the Operation Manual via SMC website, <https://www.smworld.com>

How to Order Valves

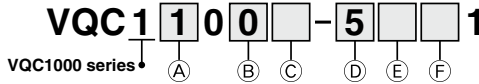

(A) Type of actuation

1	2-position single (A)4 2(B) (R)1 5 1 3(R)2 (P)	Note A	4-position dual 3-port valve (A) 4(A) 2(B) (R)1 5 1(P) 3(R)2 N.C. N.C.
	2-position double (Metal) (A)4 2(B) (R)1 5 1 3(R)2 (P)		4-position dual 3-port valve (B) 4(A) 2(B) (R)1 5 1(P) 3(R)2 N.O. N.O.
2	2-position double (Rubber) (A)4 2(B) (R)1 5 1 3(R)2 (P)	Note B	4-position dual 3-port valve (C) 4(A) 2(B) (R)1 5 1(P) 3(R)2 N.C. N.O.
	3-position closed center (A)4 2(B) (R)1 5 1 3(R)2 (P)		Note) Rubber seal only
3	3-position exhaust center (A)4 2(B) (R)1 5 1 3(R)2 (P)	Note C	4-position dual 3-port valve (C) 4(A) 2(B) (R)1 5 1(P) 3(R)2 N.C. N.O.
	3-position pressure center (A)4 2(B) (R)1 5 1 3(R)2 (P)		

(B) Seal

0	Metal seal
1	Rubber seal

(C) Function

Nil	Standard (0.4 W)
B	High-speed response type (0.95 W)
K Note 1)	High-pressure type (1.0 MPa, 0.95 W)
N Note 2)	Negative common
R Note 3)	External pilot

* When two or more symbols are specified, indicate them alphabetically. However, combination of "B" and "K" is not possible.

Note 1) Metal seal only

Note 2) When "COM" is specified for the SI unit, select and mount the valve of negative common.

Note 3) Dual 3-port is not applicable.

(D) Coil voltage

5 Note 1)	24 VDC
6	12 VDC

Note) Only 24 VDC is available with the S kit.

(E) Light/surge voltage suppressor

Nil	Yes
E Note 1, 2)	None (Non-polar)

Note 1) Not applicable to the S kit.

Note 2) A combination of "Function N (Negative common)" and "E" is unavailable.

Since "E" has no polarity, it can also be used as a negative common. Selection of "Function N" is not required.

(F) Manual override

Nil	Non-locking push type (Tool required)
B	Push-turn locking type (Tool required)
C	Turn locking type (Manual)
D	Slide locking type (Manual)

How to Order Manifold Assembly

Example

Manifold
Power supply with
M12 connector

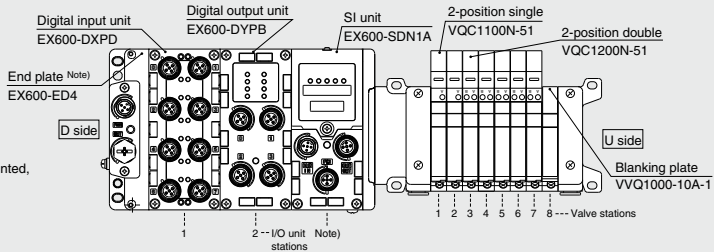

For the I/O unit part number mounted, refer to page 1393.

- Digital unit
- Analog unit

Serial transmission kit

- VV50C11-08C6SD604N2 1 set Manifold base part number
- * VQC1100N-51 2 sets Valve part number (Stations 1 to 2)
- * VQC1200N-51 5 sets Valve part number (Stations 3 to 7)
- * VVQ1000-10A-1 1 set Blanking plate number (Station 8)
- * EX600-DXPD 1 set I/O unit part number (Station 1)
- * EX600-DYPB 1 set I/O unit part number (Station 2)

The asterisk denotes the symbol for assembly. Prefix it to the part nos. of the solenoid valve, etc.

Enter in order starting from the first station on the D-side. When entry of part numbers becomes complicated, indicate with the manifold specification sheet.

Enter in order starting from the first station on the U-side. When entry of part numbers becomes complicated, indicate with the manifold specification sheet.

Note) Do not enter the SI unit part number and the end plate part number together.

VQC1000 Series

Manifold Options

Refer to pages 1134 through to 1137 for details.

Blanking plate assembly
VVQ1000-10A-1

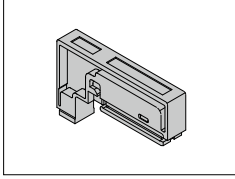

Individual SUP spacer
VVQ1000-P-1-C6-N7

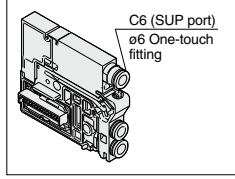

Individual EXH spacer
VVQ1000-R-1-C6-N7

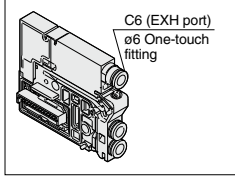

SUP block plate
VVQ1000-16A

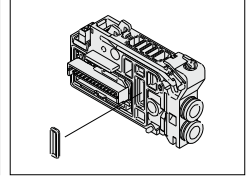

Blanking plate with connector
VVQ1000-1C-□-□

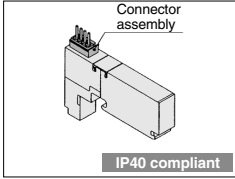

EXH block plate assembly
VVQC1000-19A-S-D-N1-N3-N7

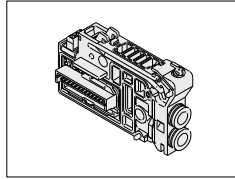

Back pressure check valve assembly [-B]
VVQ1000-18A

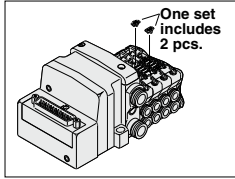

Name plate [-N]
VVQ1000-N-NC-(1 to Max. stations) (-X4)

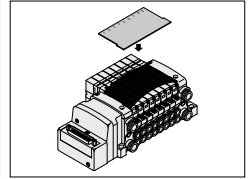

Blanking plug
VK2P-□

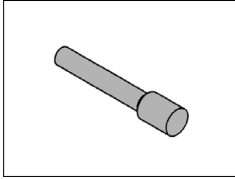

Port plug
VVQ0000-58A

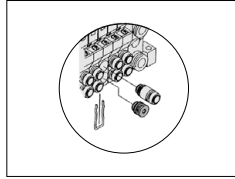

Elbow fitting assembly
VVQ1000-F-L□

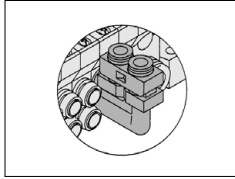

DIN rail mounting bracket [-D]
VVQ1000-57A
(For F/L/M/P/S (EX500) kit)
VVQC1000-57A-S
(For S (EX250) kit)
VVQC1000-57A-T (For T kit)

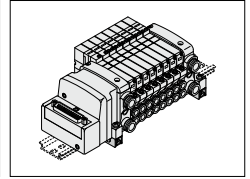

Direct EXH outlet with built-in silencer [-S]

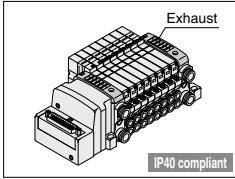

Dual flow fitting assembly
VVQ1000-52A-N9

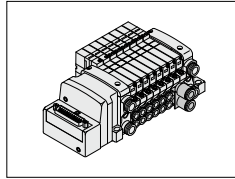

Special electrical wiring specifications [-K]

Wiring example)
D-sub connector

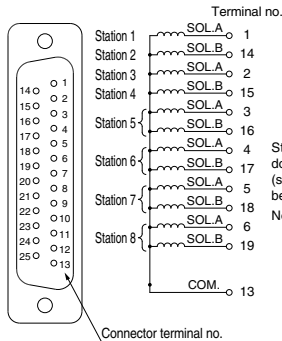

Standard manifolds are for double wiring, but mixed wiring (single and double wiring) can be specified as an option.

Note) Refer to the pages of each kit for details.

F kit P. 1118

P kit P. 1120

T kit P. 1122

L kit P. 1124

M kit P. 1126

Silencer (For EXH port)
AN15-C08

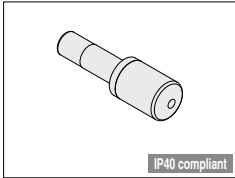

Double check block
VVQ1000-FPG-□-□

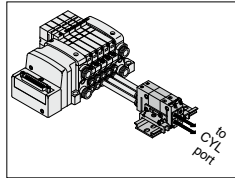

Base Mounted

Plug-in Unit

VQC2000 Series

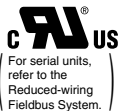

For serial units, refer to the Reduced-wiring Fieldbus System.

RoHS

The EX250/500 series is to be discontinued. When designing new equipment and facilities, consider using another series (EX260/EX600) instead.

Refer to page 1098 for details on manifolds that support safety communication (PROFIsafe).

How to Order Manifold

S kit

The selectable items vary for each series. Select from the applicable item numbers in the table below.

Series	Item number (Refer to pages 1090, 1091 and 1092)
EX600	①, ②, ④, ⑦, ⑧, ⑨, ⑩
EX245	①, ②, ④, ⑤, ⑥, ⑩
EX250	①, ②, ④, ⑧, ⑩, ⑪, ⑫, ⑬
EX500,260,126	①, ②, ④, ⑧, ⑩

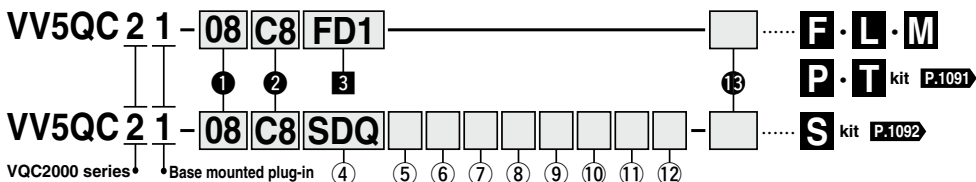

① Valve stations

01	1 station
⋮	⋮

The maximum number of stations differs depending on the electrical entry. (Refer to ④ Kit type/Electrical entry/Cable length.)

Note) In case of compatibility with the S kit/AS-Interface, the maximum number of solenoids is as shown below, so please be careful of the number of stations.

- 8 in/8 out: Maximum 8 solenoids
- 4 in/4 out: Maximum 4 solenoids

② Cylinder port size

C4	With ø4 One-touch fitting
C6	With ø6 One-touch fitting
C8	With ø8 One-touch fitting
CM	Mixed sizes and with port plug
L4	Top ported elbow with ø4 One-touch fitting
L6	Top ported elbow with ø6 One-touch fitting
L8	Top ported elbow with ø8 One-touch fitting
B4	Bottom ported elbow with ø4 One-touch fitting
B6	Bottom ported elbow with ø6 One-touch fitting
B8	Bottom ported elbow with ø8 One-touch fitting
LM	Elbow port, mixed sizes (Including upward, downward piping and mixed)

MM Note 2) Mixed size for different types of piping, option installed

Note 1) Indicate the size by means of the manifold specification sheet in case of "CM", "LM", "NM".
 Note 2) When selecting the mixed size for different types of piping or dual flow fitting assembly, enter "MM" and give instructions in the manifold specification sheet.

Note 3) Symbols for inch sizes are as follows:

- N3: ø5/32" • N7: ø1/4"
- N9: ø5/16" • NM: Mixed
- The top ported elbow is L \square and the bottom ported elbow is B \square .

⑤ With or without I/O modules (Enter EX245-compliant S kit only)

Nil	Without I/O module
Y	With I/O module

⑥ Number of I/O modules (Enter EX245-compliant S kit only)

Nil	Without I/O module (Without SI Unit)
1	1 station
⋮	⋮
8	8 stations

⑦ End plate type (Enter EX600-compliant S kit only)

Nil	Without end plate
2	M12 power supply connector, B-coded
3	7/8 inch power supply connector
4	M12 power supply connector INOUT, A-coded, Pin arrangement 1
5	M12 power supply connector INOUT, A-coded, Pin arrangement 2

Note) Without SI unit, the symbol is nil.
 * The pin layout for "4" and "5" pin connector is different.

⑨ I/O unit stations (Enter EX600-compliant S kit only)

Nil	None
1	1 station
⋮	⋮
9	9 stations

Note 1) Without SI unit, the symbol is nil.
 Note 2) SI unit is not included in I/O unit stations.
 Note 3) When I/O unit is selected, it is shipped separately, and assembled by customer. Refer to the attached operation manual for mounting method.

⑩ Number of input blocks (Enter EX250-compliant S kit only)

Nil	Without SI unit/input block (SDO)
0	Without input block
1	With 1 input block
⋮	⋮
8	With 8 input blocks

Note) For the S kit compatible with AS-Interface, the maximum number of stations is limited. Refer to page 1364 for details.

⑪ Input block type (Enter EX250-compliant S kit only)

Nil	Without input block
1	M12, 2 inputs
2	M12, 4 inputs
3	M8, 4 inputs (3 pins)

⑫ Input block specification (Enter EX250-compliant S kit only)

Nil	PNP sensor input or without input block
N	NPN sensor input

⑬ Option

Nil	None
B Note 2)	All stations with back pressure check valve
D	With DIN rail (Rail length: Standard) Note 9)
D \square Note 4)	With DIN rail (Rail length: Special) Note 9)
K Note 5)	Special wiring spec. (Except double wiring)
N Note 12)	With name plate
R Note 6)	External pilot
S Note 7)	Direct EXH outlet with built-in silencer
T Note 8)	Branched P and R ports on U-side

Note 1) When two or more symbols are specified, indicate them alphabetically. Example: -BRS
 Note 2) When a back pressure check valve is desired, and it is to be installed only in certain manifold stations, specify the mounting position by means of the manifold specification sheet.
 Note 3) When DIN rail mounting (with DIN rail) is selected with a power supply 7/8 inch connector for end plate of the VQC2000 series, and I/O unit station number is 9, and max. valve station number is 23, DIN rail mount cannot be specified for 24 stations. (Refer to the DIN rail full length on page 1109.)
 Note 4) For special DIN rail length, indicate "D \square ". (Enter the number of stations inside \square .) Example: -D08
 In this case, stations will be mounted on a DIN rail for 8 stations regardless of the actual number of manifold stations.
 The specified number of stations must be larger than the number of stations on the manifold. Indicate "-D0" for the option without DIN rail.
 Note 5) When single wiring and double wiring are mixed, specify wiring type of each station by means of the manifold specification sheet.
 Note 6) For external pilot option, "-R", indicate the external pilot specification "R" for the applicable valves as well.
 Note 7) Built-in silencer type does not satisfy IP67.
 Note 8) SUP and EXH ports on the U-side (on cylinder port side and coil side is branched.) Port is equipped with One-touch fitting for ø12.
 Note 9) When "Without SI unit (SDO, SD60)" and EX245 series are specified, "With DIN rail (D)" cannot be selected.
 Note 10) When changing the specifications of the EX600 from no DIN rail to DIN rail mounting, please consult SMC.
 Note 11) DIN rail is not attached (but shipped together) on the manifold in case of the EX600 with DIN rail. Refer to page 1143 for mounting method.
 Note 12) When mounting the slide locking manual type valve by ordering only the manifold, order the name plate separately. For details, refer to page 1139.

3 Kit type/Electrical entry/Cable length

* Numbers in parentheses represent the maximum number of solenoids in case of mixed single and double wiring. The maximum number of stations is determined by the total number of solenoids. When ordering mixed wiring, please add the option symbol "K".

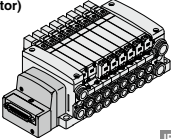
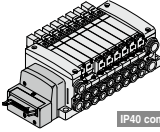
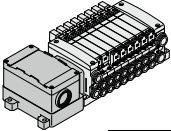
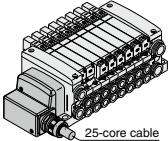
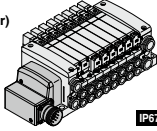
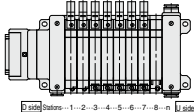
<p>F kit (D-sub connector)</p>  <p style="text-align: right;">IP40 compliant</p>		<p>P kit (Flat ribbon cable)</p> <p>Note) For a 20P flat ribbon cable, the cable assembly must be ordered separately.</p>  <p style="text-align: right;">IP40 compliant</p>		<p>T kit (Terminal block box)</p>  <p style="text-align: right;">IP67 compliant</p>		
<p>FD0 D-sub connector (25P) without cable</p>	<p>1 to 12 stations (24)</p>	<p>PD0 Flat ribbon cable (26P) without cable</p>	<p>1 to 12 stations (24)</p>	<p>TD0 Terminal block box</p>	<p>1 to 10 stations (20)</p>	
<p>FD1 D-sub connector (25P) with 1.5 m cable</p>		<p>PD1 Flat ribbon cable (26P) with 1.5 m cable</p>				
<p>FD2 D-sub connector (25P) with 3.0 m cable</p>		<p>PD2 Flat ribbon cable (26P) with 3.0 m cable</p>				
<p>FD3 D-sub connector (25P) with 5.0 m cable</p>		<p>PD3 Flat ribbon cable (26P) with 5.0 m cable</p>				
<p>L kit (Lead wire)</p>  <p style="text-align: right;">25-core cable IP67 compliant</p>		<p>M kit (Circular connector)</p>  <p style="text-align: right;">IP67 compliant</p>		 <p style="text-align: right;">IP67 compliant</p>		
<p>LD0 Lead wire (25 cores) 0.6 m lead wire</p>	<p>1 to 12 stations (24)</p>	<p>MD0 Circular connector (26P) without cable</p>	<p>1 to 12 stations (24)</p>			
<p>LD1 Lead wire (25 cores) 1.5 m lead wire</p>		<p>MD1 Circular connector (26P) with 1.5 m cable</p>				
<p>LD2 Lead wire (25 cores) 3.0 m lead wire</p>		<p>MD2 Circular connector (26P) with 3.0 m cable</p>				
		<p>MD3 Circular connector (26P) with 5.0 m cable</p>				

* Stations are counted from station 1 on the D-side.

VQC2000 Series

4 Kit type

* Numbers in parentheses represent the maximum number of solenoids in case of mixed single and double wiring. The maximum number of stations is determined by the total number of solenoids. When ordering mixed wiring, please add the option symbol "K".

S kit
(Serial transmission:
EX500 gateway-type)

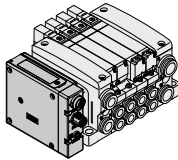

IP67 compliant
SI unit: EX500

Note A) A separate gateway unit and communication cable are required.

SD0	Without SI unit	—	—
SDA3	EX500 Gateway Decentralized System 2 (128 points)	32 outputs ^{Note 1)}	1 to 12 stations ⁽²⁴⁾

S kit
(Serial transmission:
EX260 integrated-type (for output))

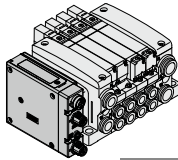

SI unit: EX260

IP40 compliant
IP67 compliant

The maximum number of stations displayed in parentheses is applied to the special wiring specifications. (Option "K")
Note 1) When using the SI unit with 32 outputs, use the GW unit compatible with the EX500 Gateway Decentralized System 2 (128 points).
Note 2) When selecting SI units with SDTC or SDTD

S kit
(Serial transmission:
EX600 integrated-type (I/O))

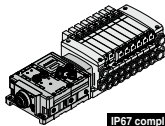

IP67 compliant
SI unit: EX600

SD60	Without SI unit	1 to 12 stations ⁽²⁴⁾
SD6Q	DeviceNet [®]	
SD6N	PROFIBUS DP	
SD6V	CC-Link	
SD6FA	PROFINET (IO-Link unit)	
SD6FB	PROFINET (OPC UA, IO-Link unit) ^{Note 5)}	
SD6EB	EtherNet/IP [™] (IO-Link unit)	
SD6DA	EtherCAT (IO-Link unit)	
SD6WE	EtherNet/IP [™] compatible wireless base ^{Note 5)}	
SD6WF	PROFINET compatible wireless base ^{Note 5)}	
SD6WS	Wireless remote ^{Note 5)}	

Symbol	Protocol	Number of outputs	Communication connector	Stations
SD0	Without SI unit			
SQA	DeviceNet [®]	32	M12	1 to 12 stations (24)
SQB		16		1 to 8 stations (16)
SNA		32		1 to 12 stations (24)
SNB		16		1 to 8 stations (16)
SNC		32		1 to 12 stations (24)
SD	PROFIBUS DP	32	D-sub ^{Note 3)}	1 to 8 stations (16)
SND		16		1 to 8 stations (16)
SVA		32		1 to 12 stations (24)
SVB		16		1 to 8 stations (16)
SDA		32		1 to 12 stations (24)
SDB	EtherCAT	16	M12	1 to 8 stations (16)
SFA		32		1 to 12 stations (24)
SFB	PROFINET	16	M12	1 to 8 stations (16)
SEA	EtherNet/IP [™]	32	M12	1 to 12 stations (24)
SEB		16		1 to 8 stations (16)
SGA		32		1 to 12 stations (24)
SGB	Ethernet POWERLINK	16	M12	1 to 8 stations (16)
SKA	IO-Link	32	M12	1 to 12 stations (24)

specifications, there are limits to the supply current from the SI unit to the input block or valve. Refer to page 1364 for details.
Note 3) When selecting SI units with SDZCN specifications only, IP40 is compatible.
Note 4) For the SI unit part no., refer to page 1093.

S kit
(Serial transmission:
EX245 integrated-type (I/O))

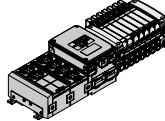

IP65 compliant
SI unit: EX245

Symbol	Protocol	Communication connector	Power supply connector	Stations
SD0	Without SI unit			
SDAAN	PROFINET	Push/Pull (SCR): 2 pcs.	Push/Pull (24 V): 2 pcs.	1 to 12 stations ⁽²⁴⁾
SDABN		Push/Pull (R45): 2 pcs.	Push/Pull (24 V): 2 pcs.	
SDACN		M12: 2 pcs.	7/8 inch: 2 pcs.	

S kit
(Serial transmission:
EX250 integrated-type (I/O))

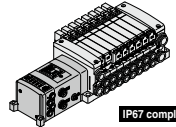

IP67 compliant
SI unit: EX250

SD0	Without SI unit	1 to 12 stations
SDQ	DeviceNet [®]	(24)
SDTA	AS-Interface, 8 in/8 out, 2 power supply systems	1 to 4 stations (8)
SDTB	AS-Interface, 4 in/4 out, 2 power supply systems	1 to 2 stations (4)
SDTC	AS-Interface, 8 in/8 out, 1 power supply systems	1 to 4 stations (8)
SDTD	AS-Interface, 4 in/4 out, 2 power supply systems	1 to 2 stations (4)
SDZEN	EtherNet/IP [™]	1 to 12 stations (24)

S kit
(Serial transmission:
EX126 integrated-type (for output))

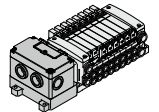

IP67 compliant
SI unit: EX126

SDVB	CC-Link	1 to 8 stations (16)
-------------	---------	----------------------

Note 5) The wireless system is suitable for use only in a country where it is in accordance with the Radio Act and regulations of that country.
Note 6) Only negative common (PNP) is available.

8) SI unit output polarity

SI unit output polarity	EX250 integrated-type (I/O) serial transmission system	EX500 Gateway Decentralized System 2 (128 points)	EX260 integrated-type (for output) serial transmission system
Nil	Positive common	—	—
N	Negative common	○	○

SI unit output polarity	EX245 integrated-type (I/O) serial transmission system	EX500 Gateway Decentralized System 2 (128 points)	EX260 integrated-type (for output) serial transmission system							EX126 integrated-type (for output) serial transmission system		
	PROFINET	PROFINET	DeviceNet [®]	PROFIBUS DP	CC-Link	EtherCAT	PROFINET	EtherNet/IP [™]	Ethernet POWERLINK	IO-Link	CC-Link	
Nil	—	—	○	○	○	○	○	○	○	○	○	
N	○	○	○	○	○	○	○	○	○	○	○	

SI unit output polarity	EX600 integrated-type (I/O) serial transmission system							Wireless remote
	DeviceNet [®]	PROFIBUS DP	CC-Link	EtherNet/IP [™]	EtherCAT	PROFINET	EtherNet/IP [™] compatible wireless base	PROFINET compatible wireless base
Nil	○	○	○	○	○	○	○	○
N	○	○	○	○	○	○	○	○

* Select "Nil" for without SI unit (SD0C).

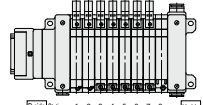

* Stations are counted from station 1 on the D-side.

Refer to the **Web Catalog** and the Operation Manual for the details of EX600 Integrated-type (For I/O) Serial Transmission System. Please download the Operation Manual via our website, <https://www.smworld.com>

SI Unit Part No.**EX500 Gateway Decentralized System 2 (128 points)**

Symbol	SI unit part no.		Page
	Negative common (PNP)		
SDA3	EX500-S103		P.1131

EX600

Symbol	Compatible protocol	SI unit part no.		Page
		Positive common (NPN)	Negative common (PNP)	
SD6Q	DeviceNet®	EX600-SDN2A	EX600-SDN1A	P.1131
SD6N	PROFIBUS DP	EX600-SPR2A	EX600-SPR1A	
SD6V	CC-Link	EX600-SMJ2	EX600-SMJ1	
SD6FA	PROFINET (IO-Link unit)	EX600-SPN4	EX600-SPN3	
SD6FB	PROFINET (OPC UA, IO-Link unit)	—	EX600-SPN31	
SD6EB	EtherNet/IP™ (IO-Link unit)	EX600-SEN8	EX600-SEN7	
SD6DA	EtherCAT (IO-Link unit)	EX600-SEC4	EX600-SEC3	
SD6WE	EtherNet/IP™ compatible wireless base ^{Note)}	EX600-WEN2	EX600-WEN1	
SD6WF	PROFINET compatible wireless base ^{Note)}	EX600-WPN2	EX600-WPN1	
SD6WS	Wireless remote ^{Note)}	EX600-WSV2	EX600-WSV1	

Note) The wireless system is suitable for use only in a country where it is in accordance with the Radio Act and regulations of that country.

EX245

Symbol	Compatible protocol	SI unit part no.	Page
SDAAN	PROFINET	EX245-SPN1A	P.1132
SDABN		EX245-SPN2A	
SDACN		EX245-SPN3A	

EX260

Symbol	Compatible protocol	Number of outputs	SI unit part no.		Communication connector	Page
			Positive common (NPN)	Negative common (PNP)		
SQA	DeviceNet®	32	EX260-SDN2	EX260-SDN1	M12	P.1132
SQB		16	EX260-SDN4	EX260-SDN3		
SNA	PROFIBUS DP	32	EX260-SPR2	EX260-SPR1	D-sub ^{Note)}	
SNB		16	EX260-SPR4	EX260-SPR3		
SNC		32	EX260-SPR6	EX260-SPR5		
SND		16	EX260-SPR8	EX260-SPR7		
SVA	CC-Link	32	EX260-SMJ2	EX260-SMJ1	M12	
SVB		16	EX260-SMJ4	EX260-SMJ3		
SDA	EtherCAT	32	EX260-SEC2	EX260-SEC1	M12	
SDB		16	EX260-SEC4	EX260-SEC3		
SFA	PROFINET	32	EX260-SPN2	EX260-SPN1	M12	
SFB		16	EX260-SPN4	EX260-SPN3		
SEA	EtherNet/IP™	32	EX260-SEN2	EX260-SEN1	M12	
SEB		16	EX260-SEN4	EX260-SEN3		
SGA	Ethernet POWERLINK	32	—	EX260-SPL1	M12	
SGB		16	—	EX260-SPL3		
SKA	IO-Link	32	—	EX260-SIL1	M12	

Note) When the communication connector specification is D-sub, the enclosure is IP40. (IP67 for other specifications)

EX250

Symbol	Compatible protocol	SI unit part no.	Page
SDQ	DeviceNet®	EX250-SDN1	P.1132
SDTA	AS-Interface, 8 in/8 out, 2 power supply systems	EX250-SAS3	
SDTB	AS-Interface, 4 in/4 out, 2 power supply systems	EX250-SAS5	
SDTC	AS-Interface, 8 in/8 out, 1 power supply systems	EX250-SAS7	
SDTD	AS-Interface, 4 in/4 out, 1 power supply systems	EX250-SAS9	
SDZEN	EtherNet/IP™	EX250-SEN1	

EX126

Symbol	Compatible protocol	SI unit part no.	Page
SDVB	CC-Link	EX126D-SMJ1	P.1132

For details about the EX series (Serial transmission system), refer to the **Web Catalog** and the Operation Manual. Please download the Operation Manual via SMC website, <https://www.smcworld.com>

How to Order Valves

VQC2000 series **1** **0** **0** **5** **1**

A
B
C
D
E
F

(A) Type of actuation

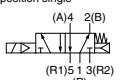
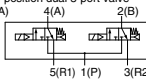
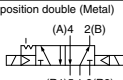
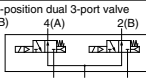
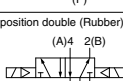
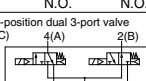
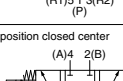
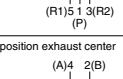
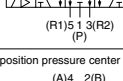
1	2-position single  (A)4 2(B) (R)1 5 1 3(R)2 (P)	A	4-position dual 3-port valve  (A) 4(A) 2(B) 5(R)1 1(P) 3(R)2 N.C. N.C.	(Note) A
2	2-position double (Metal)  (A)4 2(B) (R)1 5 1 3(R)2 (P)	B	4-position dual 3-port valve  (B) 4(A) 2(B) 5(R)1 1(P) 3(R)2 N.O. N.O.	(Note) B
	2-position double (Rubber)  (A)4 2(B) (R)1 5 1 3(R)2 (P)	C	4-position dual 3-port valve  (C) 4(A) 2(B) 5(R)1 1(P) 3(R)2 N.C. N.O.	(Note) C
3	3-position closed center  (A)4 2(B) (R)1 5 1 3(R)2 (P)	(Note) Rubber seal only		
4	3-position exhaust center  (A)4 2(B) (R)1 5 1 3(R)2 (P)			
5	3-position pressure center  (A)4 2(B) (R)1 5 1 3(R)2 (P)			

(B) Seal

0	Metal seal
1	Rubber seal

(C) Function

Nil	Standard (0.4 W)
B	High-speed response type (0.95 W)
K <small>Note 1</small>	High-pressure type (1.0 MPa, 0.95 W)
N <small>Note 2</small>	Negative common
R <small>Note 3</small>	External pilot

* When two or more symbols are specified, indicate them alphabetically. However, combination of "B" and "K" is not possible.

Note 1) Metal seal only

Note 2) When "COM." is specified for the SI unit, select and mount the valve of negative common.

Note 3) Dual 3-port type is not applicable.

(D) Coil voltage

5 <small>Note</small>	24 VDC
6	12 VDC

Note) Only 24 VDC is available with the S kit.

(E) Light/surge voltage suppressor

Nil	Yes
E <small>Note 1, 2</small>	None (Non-polar)

Note 1) Not applicable to the S kit.

Note 2) A combination of "Function N (Negative common)" and "E" is unavailable.

Since "E" has no polarity, it can also be used as a negative common. Selection of "Function N" is not required.

(F) Manual override

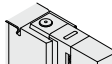
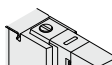
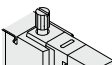
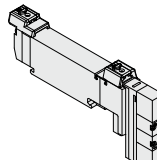
Nil	Non-locking push type (Tool required)	
B	Push-turn locking type (Tool required)	
C	Turn locking type (Tool required)	
D	Slide locking type (Manual)	

How to Order Manifold Assembly: EX600*

Example (VV5QC21-□SD6□)

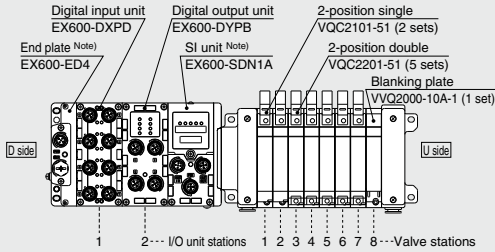

- VV5QC21-08C8SD6Q4N2...1 set (S kit 8-station manifold base part no.)
 *VQC2101-512 sets (2-position single part no.) (Stations 1 to 2)
 *VQC2201-515 sets (2-position double part no.) (Stations 3 to 7)
 *VVQ2000-10A-11 set (Blanking plate) (Station 8)
 *EX600-DXPD1 set I/O unit part number (Station 1)
 *EX600-DYPB1 set I/O unit part number (Station 2)
- ↳The asterisk denotes the symbol for assembly.
 Prefix it to the part numbers of the valve etc.

The valve arrangement is numbered as the 1st station from the D side.
 Under the manifold part number, state the valves to be mounted, then the I/O unit in order from the 1st station as shown in the figure above. If the arrangement becomes complicated, specify on a manifold specification sheet.

(Note) Do not enter the SI Unit part number and the end plate part number together.

How to Order Manifold Assembly: EX245*

Example (VV5QC21-□SDAAN□)

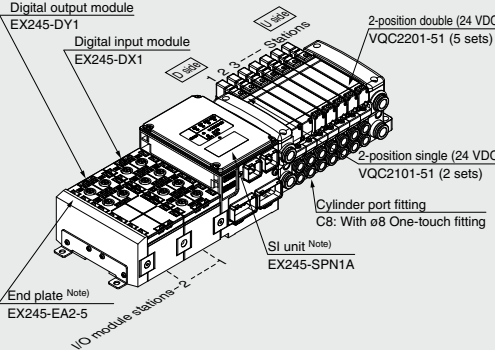

- VV5QC21-07C8SDAANY2...1 set (S kit 7-station manifold base part no.)
 *VQC2101-512 sets (Single solenoid part no.) (Stations 1 to 2)
 *VQC2201-515 sets (Double solenoid part no.) (Stations 3 to 7)
 *EX245-DX11 set (I/O unit part number) (Station 1)
 *EX245-DY11 set (I/O unit part number) (Station 2)
- ↳The asterisk denotes the symbol for assembly.
 Prefix it to the part numbers of the valve etc.

Specify the part numbers for valves and options together beneath the manifold base part number. Besides, when the arrangement will be complicated, specify them by means of the manifold specification sheet.

(Note) Do not enter the SI Unit part number and the end plate part number together.

* The EX245/250 I/O module (block) station arrangement is numbered starting from the SI unit side.

VQC2000 Series

Manifold Options Refer to pages 1138 through to 1140 for details.

Blanking plate assembly
VVQ2000-10A-1

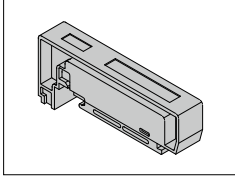

Individual SUP spacer
VVQ2000-P-1-C₈
N₉

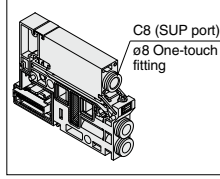

Individual EXH spacer
VVQ2000-R-1-C₈
N₉

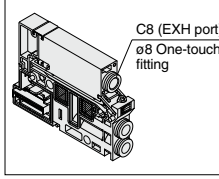

SUP block plate
VVQ2000-16A

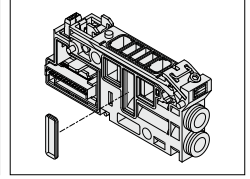

EXH block plate
VVQ2000-19A

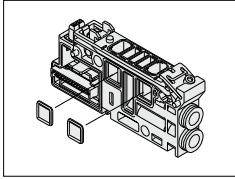

Back pressure check valve assembly [-B]
VVQ2000-18A

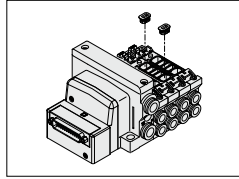

Name plate [-N]
VVQ2000-N-(1 to Max. stations) (-X4)

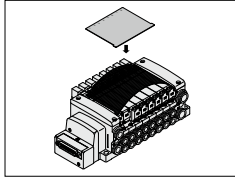

Blanking plug
KQ2P-□

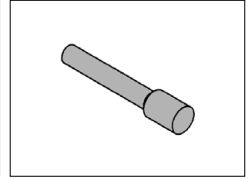

DIN rail mounting bracket [-D]

VVQ2000-57A
(For F/L/M/P/S (EX500) kit)

VVQC2000-57A-S
(For S (EX250) kit)

VVQC2000-57A-T (For T kit)

Port plug
VVQ1000-58A

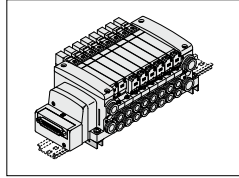
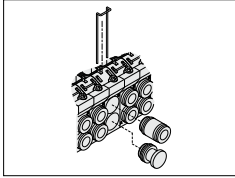

Direct EXH outlet with built-in silencer [-S]

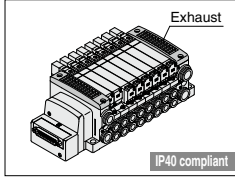

Silencer (For EXH port)
AN20-C10

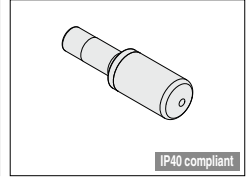

Elbow fitting assembly
VVQ2000-F-L-□

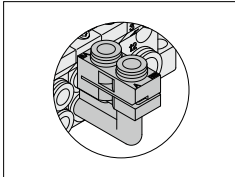

Dual flow fitting assembly
VVQ2000-52A-C₁₀
N₁₁

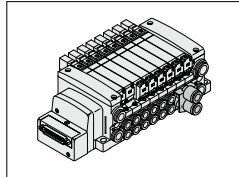

Double check block
VVQ2000-FPG-□-□-□

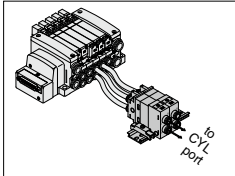

Special electrical wiring specifications [-K]

Wiring example)
D-sub connector

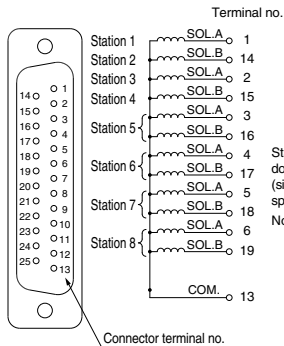

Standard manifolds are for double wiring, but mixed wiring (single and double wiring) can be specified as an option.

Note) Refer to the pages of each kit for details.

F kit P. 1118

P kit P. 1120

T kit P. 1122

L kit P. 1124

M kit P. 1126

Base Mounted Plug-in Unit

EX260 Safety Communication Protocol (PROFIsafe)

VQC1000/2000 Series



Using the safety communication protocol

Refer to the EX260 Web Catalog for details on units that support the safety communication protocol. When using a manifold valve within an ISO 13849-compliant safety system, the device needs to be considered from both the pneumatic circuit and the electric side. Devices (including valves) need to be selected based on whether their functions are in line with the safety level of the equipment as a whole. The use of valves that have been validated as being compliant with ISO 13849-2 may be required. For details on valves that have been validated, please contact SMC. In addition, refer to "Safety Instructions" for precautions on model selection.

Refer to pages 1084 and 1090 for details on manifolds that support Fieldbus and Industrial Ethernet.

How to Order Manifolds

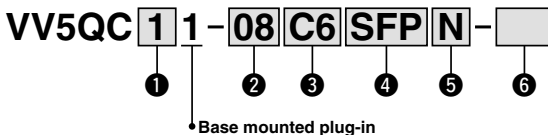

1 Series

1	VQC1000
2	VQC2000

2 Valve stations

Symbol	Stations	Note
01	1 station	Double wiring ^{Note 1)}
⋮	⋮	
12	12 stations	
01	1 station	Special wiring spec. ^{Note 2)} (Up to 24 solenoids available)
⋮	⋮	
24	24 stations	

Note 1) Double wiring: 2-position single, double, 3-position, and 4-position wiring can be used on all manifold stations.
Use of a 2-position single solenoid will result in an unused control signal. If this is not desired, order with a specified layout.

Note 2) Special wiring spec.: Indicate "K" for an option. Indicate the wiring specifications on the manifold specification sheet.
(Note that 2-position double, 3-position, and 4-position valves cannot be used where single wiring has been specified.)

3 Cylinder port size

		VQC1000	VQC2000
C3	With ø3.2 One-touch fitting	●	—
C4	With ø4 One-touch fitting	●	—
C6	With ø6 One-touch fitting	●	●
C8	With ø8 One-touch fitting	—	●
M5	M5 thread	●	—
CM	Mixed sizes and with port plug	●	—
L3	Top ported elbow with ø3.2 One-touch fitting	●	—
L4	Top ported elbow with ø4 One-touch fitting	●	—
L6	Top ported elbow with ø6 One-touch fitting	●	●
L8	Top ported elbow with ø8 One-touch fitting	—	●
L5	M5 thread	●	—
B3	Bottom ported elbow with ø3.2 One-touch fitting	●	—
B4	Bottom ported elbow with ø4 One-touch fitting	●	—
B6	Bottom ported elbow with ø6 One-touch fitting	●	●
B8	Bottom ported elbow with ø8 One-touch fitting	—	●
B5	M5 thread	●	—
LM	Elbow port, mixed sizes (including upward, downward piping and mixed)	●	●
MM ^{Note 2)}	Mixed size for different types of piping, option installed	●	●

Note 1) Indicate the size by means of the manifold specification sheet in case of "CM", "LM", "NM".
Note 2) When selecting the mixed size for different types of piping or dual flow fitting assembly, enter "MM" and give instructions in the manifold specification sheet.

Note 3) Symbols for inch sizes are as follows:

- N1: ø1/8" (VV5QC11 only) - N3: ø5/32"
- N7: ø1/4" - N9: ø5/16" (VV5QC21 only)
- NM: Mixed

The top ported elbow is LN□ and the bottom ported elbow is BN□.

4 Kit type

Serial transmission: EX260 integrated-type (for output) IP67 compliant

Symbol	Protocol	Number of outputs	Communication connector	SI unit part no.
SD0			Without SI unit	—
SFP	PROFIsafe	32	M12	EX260-FPS1

5 SI unit output polarity

SI unit output polarity	EX260 integrated-type (for output) serial transmission system	
	PROFIsafe	
N	Negative common	○

Note) Positive common (NPN) type is not applicable.

6 Option

NIL	None
B ^{Note 2)}	All stations with back pressure check valve
D	With DIN rail (Rail length: Standard) ^{Note 7)}
D□ ^{Note 3)}	With DIN rail (Rail length: Special) ^{Note 7)}
K ^{Note 4)}	Special wiring spec. (Except double wiring)
N ^{Note 10)}	With name plate
R ^{Note 5)}	External pilot
S ^{Note 6)}	Direct EXH outlet with built-in silencer
T ^{Note 9)}	Branched P and R ports on U-side

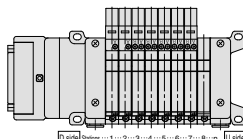

* Stations are counted from station 1 on the D-side.

- Note 1) When two or more symbols are specified, indicate them alphabetically. Example: -BRS
Note 2) When a back pressure check valve is desired, and it is to be installed only in certain manifold stations, specify the mounting position by means of the manifold specification sheet.
Note 3) For special DIN rail length, indicate "D□". (Enter the number of stations inside □). Example: -D08
In this case, stations will be mounted on a DIN rail for 8 stations regardless of the actual number of manifold stations. The specified number of stations must be larger than the number of stations on the manifold.
Indicate "D0" for the option without DIN rail.
Note 4) When single wiring and double wiring are mixed, specify wiring type of each station by means of the manifold specification sheet.
Note 5) For external pilot option, "-R", indicate the external pilot specification "R" for the applicable valves as well.
Note 6) Built-in silencer type does not satisfy IP67.
Note 7) When "Without SI unit (SD0)" is specified, "With DIN rail (D)" cannot be selected.
Note 8) When mounting the blanking plate with connector by ordering only the manifold, order the name plate separately. For details, refer to page 1135.
Note 9) VQC2000 only
SUP and EXH ports on the U-side (on cylinder port side and coil side is branched.) Port is equipped with One-touch fitting for ø12.

How to Order Valves

For details on valves that have been validated, please contact SMC.

SI Unit Part No.

EX260 SI Unit (Safety Communication)

EX260-F **PS1**

• **Communication protocol**

Symbol	Protocol	Number of outputs	SI unit output polarity	Communication connector	Manifold symbol	Page
PS1	PROFIsafe	32	Source/PNP (Negative common)	M12	SFPN	1132

For details about the EX series (Serial transmission system), refer to the **Web Catalog** and the Operation Manual. Please download the Operation Manual via SMC website, <https://www.smcworld.com>

Plug-in Unit

Model

Symbol

2-position single

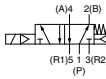

2-position double (Metal)

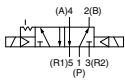

2-position double (Rubber)

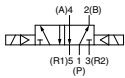

3-position closed center

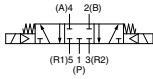

3-position exhaust center

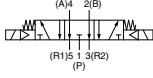

3-position pressure center

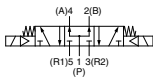

4-position dual 3-port valve (A)

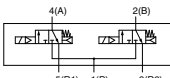

4-position dual 3-port valve (B)

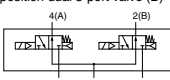

4-position dual 3-port valve (C)

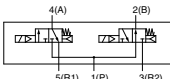

Series	Type of actuation	Model		Flow rate characteristics						Response time ^{Note 2)} (ms)		Weight (g)	
				1 → 4, 2 (P → A, B)			4, 2 → 5, 3 (A, B → R1, R2)			Standard: 0.4 W	High-speed response: 0.95 W		
				C [dm ³ /(s·bar)]	b	Cv	C [dm ³ /(s·bar)]	b	Cv				
VQC1000	2-position	Single	Metal seal	VQC1100	0.70	0.15	0.16	0.72	0.25	0.18	15 or less	12 or less	67
			Rubber seal	VQC1101	0.85	0.20	0.21	1.0	0.30	0.25	20 or less	15 or less	
	2-position	Double	Metal seal	VQC1200	0.70	0.15	0.16	0.72	0.25	0.18	13 or less	10 or less	77
			Rubber seal	VQC1201	0.85	0.20	0.21	1.0	0.30	0.25	20 or less	15 or less	
	3-position	Closed center	Metal seal	VQC1300	0.68	0.15	0.16	0.72	0.25	0.18	26 or less	20 or less	77
			Rubber seal	VQC1301	0.70	0.20	0.16	0.65	0.42	0.18	33 or less	25 or less	
		Exhaust center	Metal seal	VQC1400	0.68	0.15	0.16	0.72	0.25	0.18	26 or less	20 or less	
			Rubber seal	VQC1401	0.70	0.20	0.16	1.0	0.30	0.25	33 or less	25 or less	
	Pressure center	Metal seal	VQC1500	0.70	0.15	0.16	0.72	0.25	0.18	26 or less	20 or less	77	
		Rubber seal	VQC1501	0.85	0.20	0.21	0.65	0.42	0.18	33 or less	25 or less		
4-position	Dual 3-port valve	Rubber seal	VQC1 ^A _C 01	0.70	0.20	0.16	0.70	0.20	0.16	33 or less	25 or less	95	
		Metal seal	VQC2100	2.0	0.15	0.46	2.6	0.15	0.60	29 or less	22 or less		
VQC2000	2-position	Single	Metal seal	VQC2100	2.0	0.15	0.46	2.6	0.15	0.60	29 or less	22 or less	95
			Rubber seal	VQC2101	2.2	0.28	0.55	3.2	0.30	0.80	31 or less	24 or less	
	2-position	Double	Metal seal	VQC2200	2.0	0.15	0.46	2.6	0.15	0.60	20 or less	15 or less	105
			Rubber seal	VQC2201	2.2	0.28	0.55	3.2	0.30	0.80	26 or less	20 or less	
	3-position	Closed center	Metal seal	VQC2300	2.0	0.15	0.46	2.0	0.18	0.46	38 or less	29 or less	105
			Rubber seal	VQC2301	2.0	0.28	0.49	2.2	0.31	0.60	44 or less	34 or less	
	3-position	Exhaust center	Metal seal	VQC2400	2.0	0.15	0.46	2.6	0.15	0.60	38 or less	29 or less	105
			Rubber seal	VQC2401	2.0	0.28	0.49	3.2	0.30	0.80	44 or less	34 or less	
	3-position	Pressure center	Metal seal	VQC2500	2.4	0.17	0.57	2.0	0.18	0.46	38 or less	29 or less	105
			Rubber seal	VQC2501	3.2	0.28	0.80	2.2	0.31	0.60	44 or less	34 or less	
4-position	Dual 3-port valve	Rubber seal	VQC2 ^A _C 01	1.8	0.28	0.46	1.8	0.28	0.46	44 or less	34 or less	105	
		Metal seal	VQC2100	2.0	0.15	0.46	2.6	0.15	0.60	29 or less	22 or less		

Note 1) Values represented in this column are in the following conditions:

VQC1000: Cylinder port size C6 without a back pressure check valve

VQC2000: Cylinder port size C8 without a back pressure check valve

Note 2) Values represented in this column are based on JIS B 8419: 2010 (operating with clean air and a supply pressure of 0.5 MPa. Equipped with light/surge voltage suppressor. Values vary depending on the pressure as well as the air quality.) Values for double type are when the switch is turned ON.

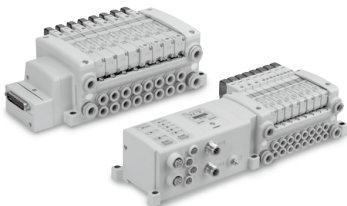

Standard Specifications

Valve specifications	Valve type	Metal seal	Rubber seal	
	Fluid	Air		
	Maximum operating pressure	0.7 MPa (High-pressure type: 1.0 MPa)		
	Minimum operating pressure	Single	0.1 MPa	0.15 MPa
		Double	0.1 MPa	
		3-position	0.1 MPa	0.2 MPa
		4-position	—	0.15 MPa
	Ambient and fluid temperature	-10 to 50°C ^{Note 1)}		
	Lubrication	Not required		
	Manual override	Push type, Locking type (Tool required) semi-standard		
Impact/Vibration resistance	150/30 m/s ² ^{Note 2)}			
Enclosure	Dustproof (IP67 compatible) ^{Note 3)}			
Electrical specifications	Rated coil voltage	24 VDC		
	Allowable voltage fluctuation	±10% of rated voltage		
	Coil insulation type	Equivalent to Class B		
	Power consumption (Current)	24 VDC	0.4 W DC (17 mA), 0.95 W DC (40 mA) ^{Note 4)}	
		12 VDC	0.4 W DC (34 mA), 0.95 W DC (80 mA) ^{Note 4)}	

Note 1) Use dry air to prevent condensation when operating at low temperatures.

Note 2) Impact resistance No malfunction resulted from the impact test using a drop impact tester. Test was performed one time each in the axial and right angle directions of the main valve and armature for both energized and de-energized states.

Vibration resistance ... No malfunction occurred in a one-sweep test between 45 and 2000 Hz. Test was performed in the axial and right angle directions of the main valve and armature for both energized and de-energized states.

Note 3) Refer to pages 1080 and 1081 for applicable variations.

Note 4) Value for high-speed response, high-pressure type (0.95 W)

Manifold Specifications

Series	Base model	Connection type	Piping specifications		Applicable stations ^{Note 2)}	Applicable solenoid valves	5-station weight (g)	
			Port direction	Port size ^{Note 1)}				
				1, 3 (P, R)				2, 4 (A, B)
VQC1000	VV5QC11-□□□	F kit: D-sub connector P kit: Flat ribbon cable T kit: Terminal block box S kit: Serial transmission L kit: Lead wire M kit: Circular connector	Side	C8 (ø8) [Option: Direct EXH outlet with built-in silencer]	C3 (ø3.2) C4 (ø4) C6 (ø6) M5 (M5 thread)	(F/L/M/P kit 1 to 12 stations) (T kit 1 to 10 stations)	VQC1□00-5 VQC1□01-5	643 (Single) 754 (Double, 3-position)
VQC2000	VV5QC21-□□□		Side	C10 (ø10) [Option: Direct EXH outlet with built-in silencer] Branch type C12 (ø12)	C4 (ø4) C6 (ø6) C8 (ø8)		(S kit ^{Note 3)} 1 to 8 stations: EX500 1 to 12 stations: EX250 EX245	VQC2□00-5 VQC2□01-5

Note 1) Inch-size One-touch fittings are also available.

Note 2) Special wiring specifications are available as semi-standard to increase the maximum number of stations.

Note 3) Depending on the protocol, there is a limit to the number of stations an S kit can be applied to. Refer to page 1099 for details.

VQC Series

S VQC1000 Series

Kit (Serial transmission) For EX500 Gateway Decentralized System 2 (128 points) IP67 compliant

VV5QC11

S kit (Serial transmission kit: EX500)

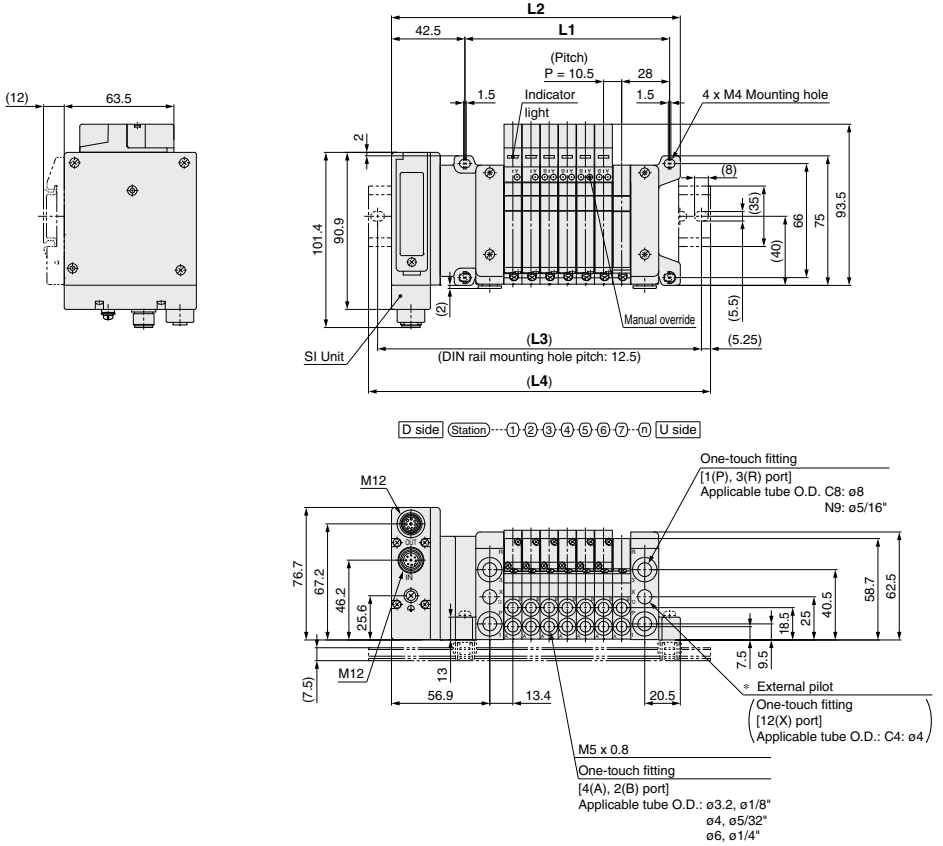

L: Dimensions

		n: Stations														
L	n	1	2	3	4	5	6	7	8	9	10	11	12	13	14	15
L1		55.5	66	76.5	87	97.5	108	118.5	129	139.5	150	160.5	171	181.5	192	202.5
L2		104.2	114.7	125.2	135.7	146.2	156.7	167.2	177.7	188.2	198.7	209.2	219.7	230.2	240.7	251.2
L3		125	137.5	150	162.5	175	187.5	187.5	200	212.5	225	237.5	250	250	262.5	275
L4		135.5	148	160.5	173	185.5	198	198	210.5	223	235.5	248	260.5	260.5	273	285.5
L	n	16	17	18	19	20	21	22	23	24						
L1		213	223.5	234	244.5	255	265.5	276	286.5	297						
L2		261.7	272.2	282.7	293.2	303.7	314.2	324.7	335.2	345.7						
L3		287.5	300	312.5	325	325	337.5	350	362.5	375						
L4		298	310.5	323	335.5	335.5	348	360.5	373	385.5						

S VQC2000 Series

Kit (Serial transmission) For EX500 Gateway Decentralized System 2 (128 points) IP67 compliant

VV5QC21 S kit (Serial transmission kit: EX500)

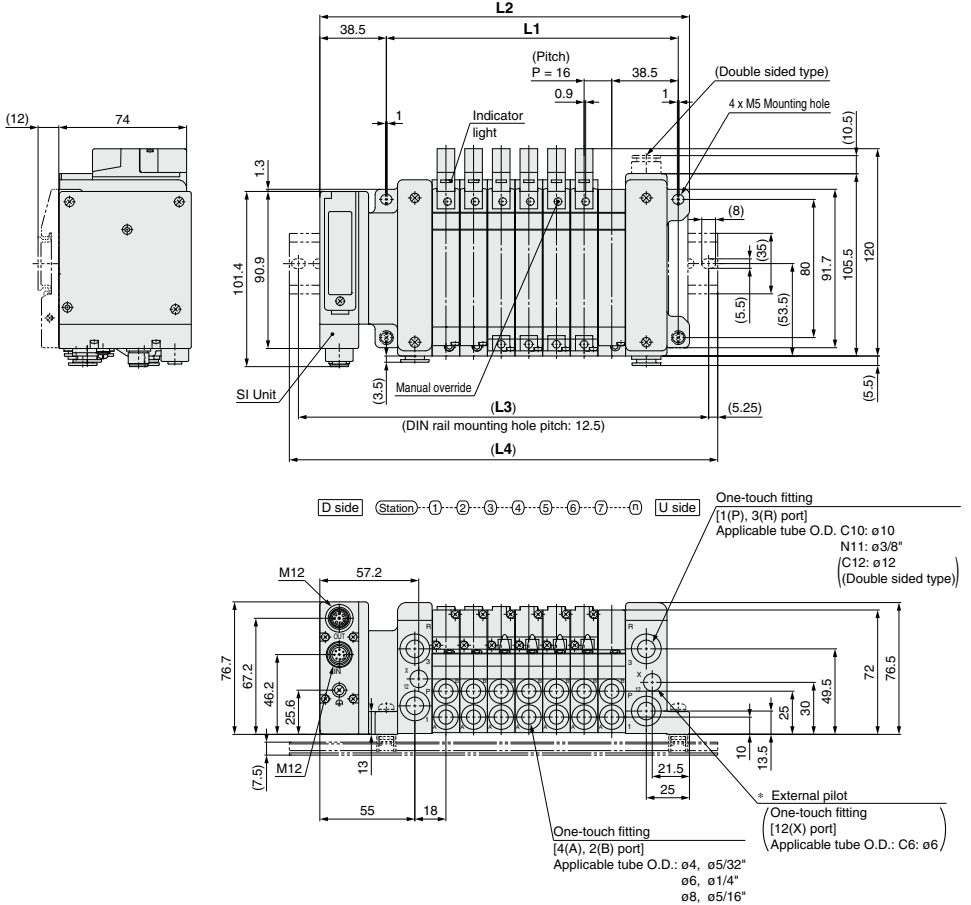

L: Dimensions

L \ n	1	2	3	4	5	6	7	8	9	10	11	12	13	14	15
L1	73	89	105	121	137	153	169	185	201	217	233	249	265	281	297
L2	118	134	150	166	182	198	214	230	246	262	278	294	310	326	342
L3	137.5	162.5	175	187.5	212.5	225	237.5	250	275	287.5	300	325	337.5	350	362.5
L4	148	173	185.5	198	223	235.5	248	260.5	285.5	298	310.5	335.5	348	360.5	373

L \ n	16	17	18	19	20	21	22	23	24
L1	313	329	345	361	377	393	409	425	441
L2	358	374	390	406	422	438	454	470	486
L3	387.5	400	412.5	437.5	450	462.5	475	500	512.5
L4	398	410.5	423	448	460.5	473	485.5	510.5	523

n: Stations

VQC Series

S VQC1000 Series

Kit (Serial transmission) For EX600 Integrated-type (I/O) Serial Transmission System IP67 compliant

VV5QC11

S kit (Serial transmission kit: EX600)

Power supply with M12 connector

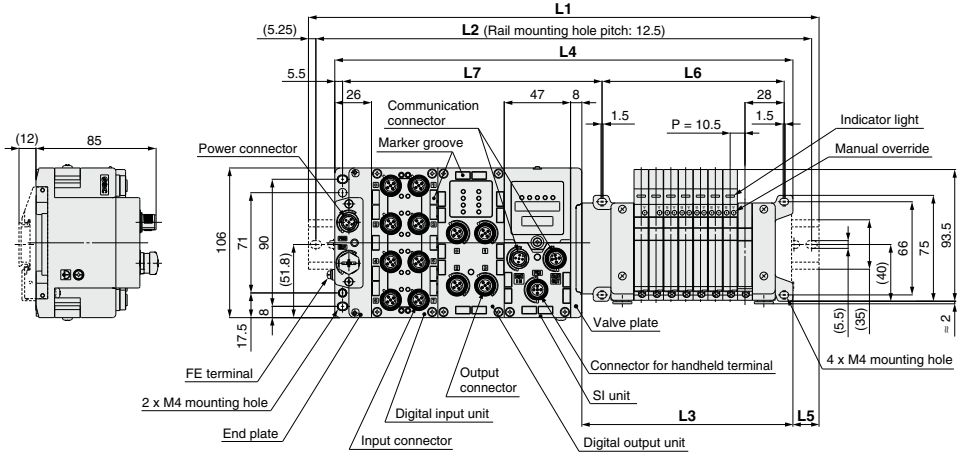

D side (Stations) ①②③④⑤⑥⑦⑧⑨⑩ U side

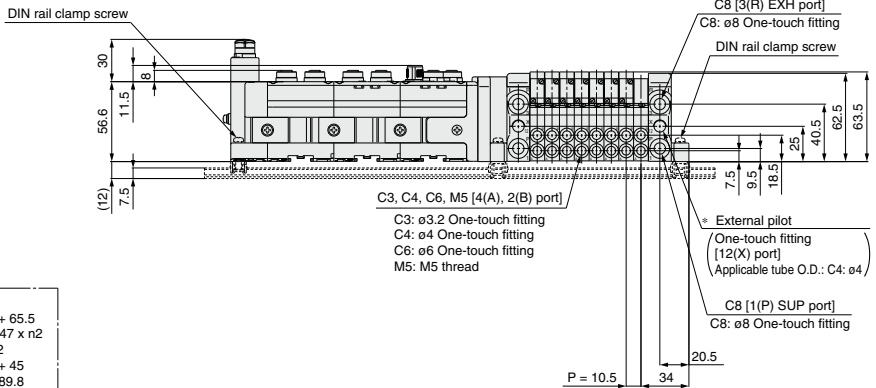

$$\begin{aligned}
 L2 &= L1 - 10.5 \\
 L3 &= 10.5 \times n1 + 65.5 \\
 L4 &= L3 + 81 + 47 \times n2 \\
 L5 &= (L1 - L4) / 2 \\
 L6 &= 10.5 \times n1 + 45 \\
 L7 &= 47 \times n2 + 89.8
 \end{aligned}$$

L1: DIN Rail Full Length

I/O unit stations (n2)	Valve stations (n1)																							
	1	2	3	4	5	6	7	8	9	10	11	12	13	14	15	16	17	18	19	20	21	22	23	24
0	198	198	210.5	223	235.5	248	260.5	260.5	273	285.5	298	310.5	323	335.5	335.5	348	360.5	373	385.5	398	398	410.5	423	435.5
1	235.5	248	260.5	273	285.5	298	298	310.5	323	335.5	348	360.5	360.5	373	385.5	398	410.5	423	423	435.5	448	460.5	473	485.5
2	285.5	298	310.5	323	323	335.5	348	360.5	373	385.5	398	398	410.5	423	435.5	448	460.5	473	485.5	498	498	510.5	523	523
3	335.5	348	360.5	360.5	373	385.5	398	410.5	423	423	435.5	448	460.5	473	485.5	498	510.5	523	523	535.5	548	560.5	560.5	573
4	385.5	385.5	398	410.5	423	435.5	448	460.5	460.5	473	485.5	498	510.5	523	523	535.5	548	560.5	573	585.5	598	598	610.5	623
5	423	435.5	448	460.5	473	485.5	485.5	498	510.5	523	535.5	548	548	560.5	573	585.5	598	610.5	623	623	635.5	648	660.5	673
6	473	485.5	498	510.5	523	523	535.5	548	560.5	573	585.5	585.5	598	610.5	623	635.5	648	648	660.5	673	685.5	698	710.5	710.5
7	523	535.5	548	548	560.5	573	585.5	598	610.5	610.5	623	635.5	648	660.5	673	685.5	685.5	698	710.5	723	735.5	748	748	760.5
8	573	585.5	585.5	598	610.5	623	635.5	648	648	660.5	673	685.5	698	710.5	710.5	723	735.5	748	760.5	773	773	785.5	798	810.5
9	610.5	623	635.5	648	660.5	673	673	685.5	698	710.5	723	735.5	748	748	760.5	773	785.5	798	810.5	810.5	823	835.5	848	860.5

S VQC1000 Series

Kit (Serial transmission) For EX600 Integrated-type (I/O) Serial Transmission System **IP67 compliant**

VV5QC11
S kit (Serial transmission kit: EX600)
 Power supply with 7/8 inch connector

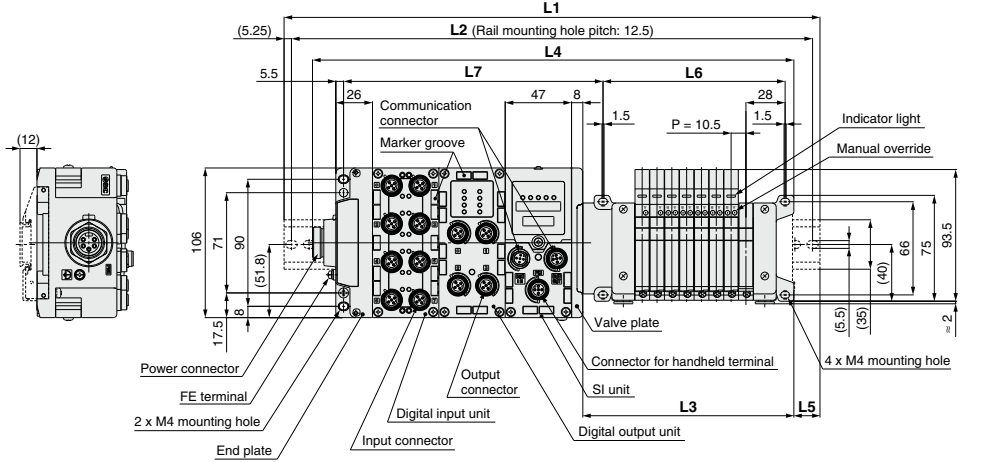

D side (Stations) ①-②-③-④-⑤-⑥-⑦-⑧-⑨ U side

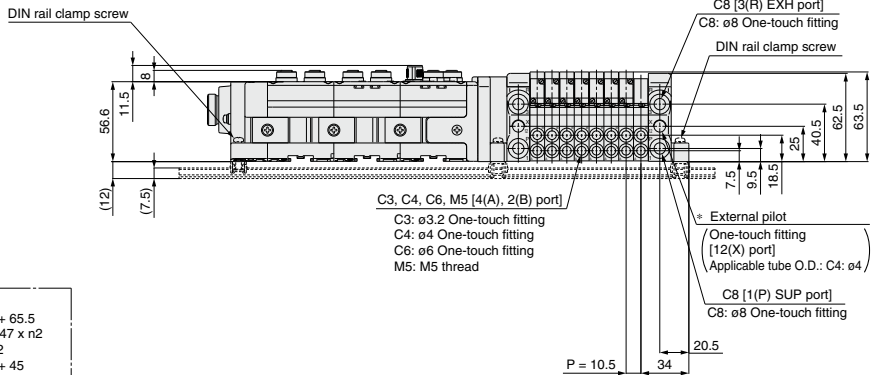

$L2 = L1 - 10.5$
 $L3 = 10.5 \times n1 + 65.5$
 $L4 = L3 + 81 + 47 \times n2$
 $L5 = (L1 - L4) / 2$
 $L6 = 10.5 \times n1 + 45$
 $L7 = 47 \times n2 + 89.8$

L1: DIN Rail Full Length

I/O unit stations (n2)	Valve stations (n1)																							
	1	2	3	4	5	6	7	8	9	10	11	12	13	14	15	16	17	18	19	20	21	22	23	24
0	210.5	223	235.5	235.5	248	260.5	273	285.5	298	298	310.5	323	335.5	348	360.5	373	373	385.5	398	410.5	423	435.5	435.5	448
1	260.5	273	273	285.5	298	310.5	323	335.5	335.5	348	360.5	373	385.5	398	398	410.5	423	435.5	448	460.5	460.5	473	485.5	498
2	298	310.5	323	335.5	348	360.5	360.5	373	385.5	398	410.5	423	435.5	448	460.5	473	485.5	498	510.5	523	535.5	548	558.5	598
3	348	360.5	373	385.5	398	398	410.5	423	435.5	448	460.5	473	485.5	498	510.5	523	535.5	548	560.5	573	585.5	598	610.5	623
4	398	410.5	423	423	435.5	448	460.5	473	485.5	498	498	510.5	523	535.5	548	560.5	573	585.5	598	610.5	623	635.5	648	660.5
5	448	460.5	460.5	473	485.5	498	510.5	523	523	535.5	548	560.5	573	585.5	598	610.5	623	635.5	648	660.5	673	685.5	698	710.5
6	485.5	498	510.5	523	535.5	548	560.5	560.5	573	585.5	598	610.5	623	623	635.5	648	660.5	673	685.5	698	710.5	723	735.5	748
7	535.5	548	560.5	573	585.5	585.5	598	610.5	623	635.5	648	648	660.5	673	685.5	698	710.5	723	723	735.5	748	760.5	773	785.5
8	585.5	598	610.5	623	623	635.5	648	660.5	673	685.5	685.5	698	710.5	723	735.5	748	748	760.5	773	785.5	798	810.5	810.5	823
9	635.5	648	648	660.5	673	685.5	698	710.5	710.5	723	735.5	748	760.5	773	785.5	785.5	798	810.5	823	835.5	848	848	860.5	873

VQC Series

S VQC2000 Series

Kit (Serial transmission) For EX600 Integrated-type (I/O) Serial Transmission System **IP67 compliant**

VV5QC21

S kit (Serial transmission kit: EX600)

Power supply with M12 connector

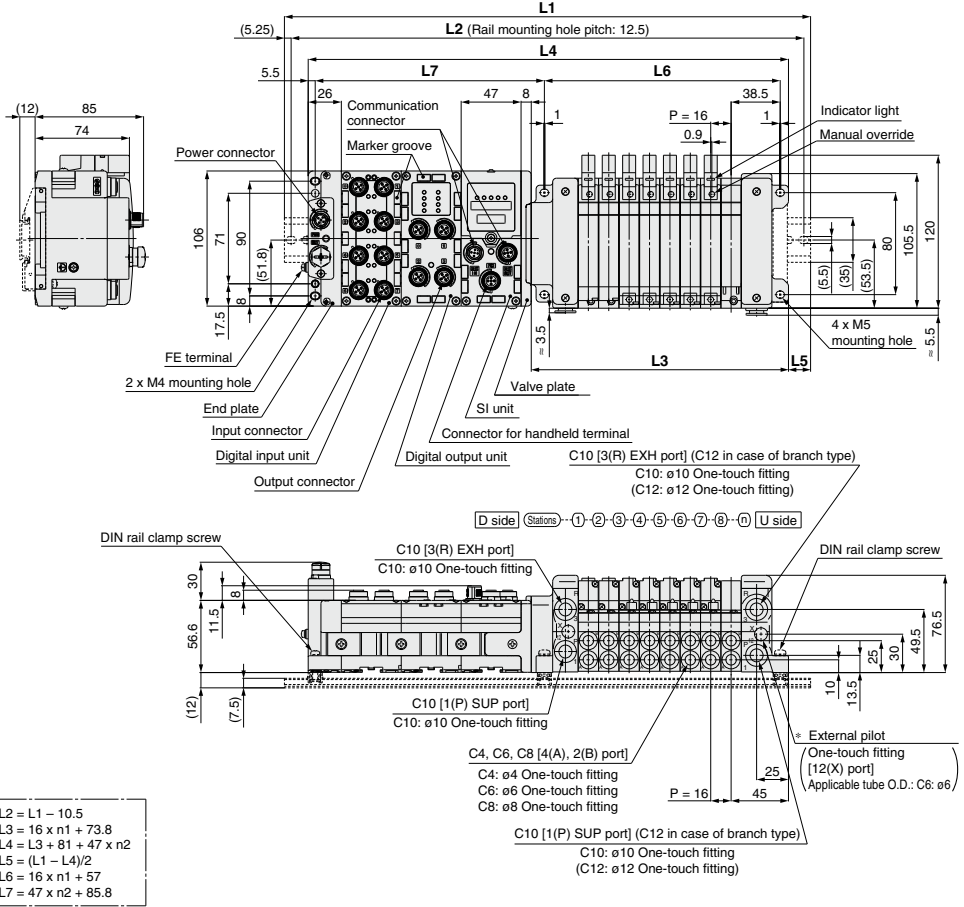

L1: DIN Rail Full Length

I/O unit stations (n2) \ Valve stations (n1)	1	2	3	4	5	6	7	8	9	10	11	12	13	14	15	16	17	18	19	20	21	22	23	24	
0	210.5	223	235.5	260.5	273	285.5	298	323	335.5	348	373	385.5	398	410.5	435.5	448	460.5	473	498	510.5	523	548	560.5	573	573
1	248	273	285.5	298	323	335.5	348	360.5	385.5	398	410.5	435.5	448	460.5	473	498	510.5	523	548	560.5	573	585.5	610.5	623	623
2	298	323	335.5	348	360.5	385.5	398	410.5	423	448	460.5	473	498	510.5	523	535.5	560.5	573	585.5	610.5	623	635.5	648	673	673
3	348	360.5	385.5	398	410.5	423	448	460.5	473	498	510.5	523	535.5	560.5	573	585.5	598	623	635.5	648	673	685.5	698	710.5	710.5
4	398	410.5	423	448	460.5	473	485.5	510.5	523	535.5	560.5	573	585.5	598	623	635.5	648	673	685.5	698	710.5	735.5	748	760.5	760.5
5	448	460.5	473	485.5	510.5	523	535.5	548	573	585.5	598	623	635.5	648	660.5	685.5	698	710.5	735.5	748	760.5	773	798	810.5	810.5
6	485.5	510.5	523	535.5	548	573	585.5	598	623	635.5	648	660.5	685.5	698	710.5	723	748	760.5	773	798	810.5	823	835.5	860.5	860.5
7	535.5	548	573	585.5	598	610.5	635.5	648	660.5	685.5	698	710.5	723	748	760.5	773	798	810.5	823	835.5	860.5	873	885.5	898	898
8	585.5	598	610.5	635.5	648	660.5	673	698	710.5	723	748	760.5	773	785.5	810.5	823	835.5	860.5	873	885.5	898	923	935.5	948	948
9	635.5	648	660.5	673	698	710.5	723	748	760.5	773	785.5	810.5	823	835.5	848	873	885.5	898	923	935.5	948	960.5	985.5	985.5	985.5

S VQC2000 Series

Kit (Serial transmission) For EX600 Integrated-type (I/O) Serial Transmission System **IP67 compliant**

VV5QC21
S kit (Serial transmission kit: EX600)
 Power supply with 7/8 inch connector

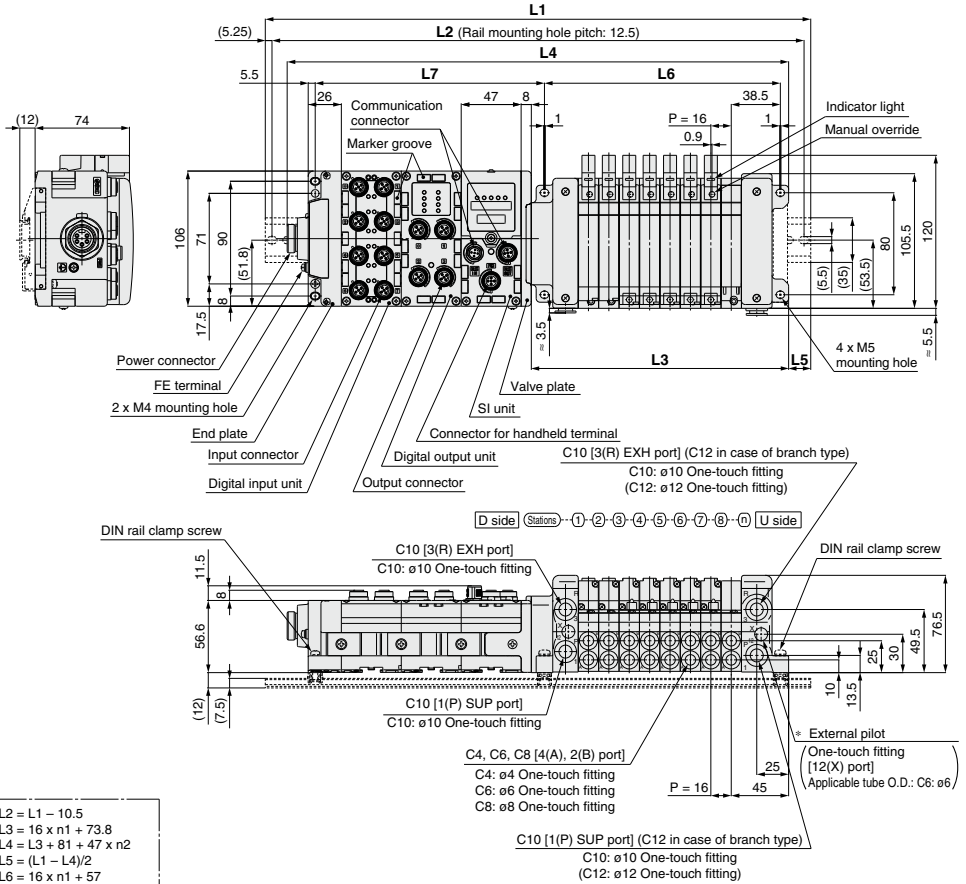

- L2 = L1 - 10.5
- L3 = 16 x n1 + 73.8
- L4 = L3 + 81 + 47 x n2
- L5 = (L1 - L4) / 2
- L6 = 16 x n1 + 57
- L7 = 47 x n2 + 85.8

L1: DIN Rail Full Length

I/O unit stations (n2) \ Valve stations (n1)	1	2	3	4	5	6	7	8	9	10	11	12	13	14	15	16	17	18	19	20	21	22	23	24
0	223	235.5	260.5	273	285.5	298	323	335.5	348	373	385.5	398	410.5	435.5	448	460.5	485.5	498	510.5	523	548	560.5	573	585.5
1	273	285.5	298	323	335.5	348	360.5	385.5	398	410.5	435.5	448	460.5	473	498	510.5	523	548	560.5	573	585.5	610.5	623	635.5
2	323	335.5	348	360.5	385.5	398	410.5	435.5	448	460.5	473	498	510.5	523	535.5	560.5	573	585.5	610.5	623	635.5	648	673	685.5
3	360.5	385.5	398	410.5	423	448	460.5	473	498	510.5	523	535.5	560.5	573	585.5	610.5	623	635.5	648	673	685.5	698	710.5	735.5
4	410.5	423	448	460.5	473	485.5	510.5	523	535.5	560.5	573	585.5	598	623	635.5	648	673	685.5	698	710.5	735.5	748	760.5	785.5
5	460.5	473	485.5	510.5	523	535.5	560.5	573	585.5	598	623	635.5	648	660.5	685.5	698	710.5	735.5	748	760.5	773	798	810.5	823
6	510.5	523	535.5	548	573	585.5	598	623	635.5	648	660.5	685.5	698	710.5	735.5	748	760.5	773	798	810.5	823	835.5	860.5	873
7	548	573	585.5	598	610.5	635.5	648	660.5	685.5	698	710.5	723	748	760.5	773	798	810.5	823	835.5	860.5	873	885.5	910.5	923
8	598	610.5	635.5	648	660.5	685.5	698	710.5	723	748	760.5	773	785.5	810.5	823	835.5	860.5	873	885.5	898	923	935.5	948	973
9	648	660.5	673	698	710.5	723	748	760.5	773	785.5	810.5	823	835.5	860.5	873	885.5	898	923	935.5	948	960.5	985.5	985.5	-

VQC Series

S VQC2000 Series Kit (Serial transmission) EX245

IP65 compliant

VV5QC21 S kit (Serial transmission kit: EX245)

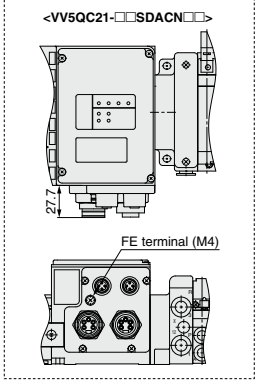
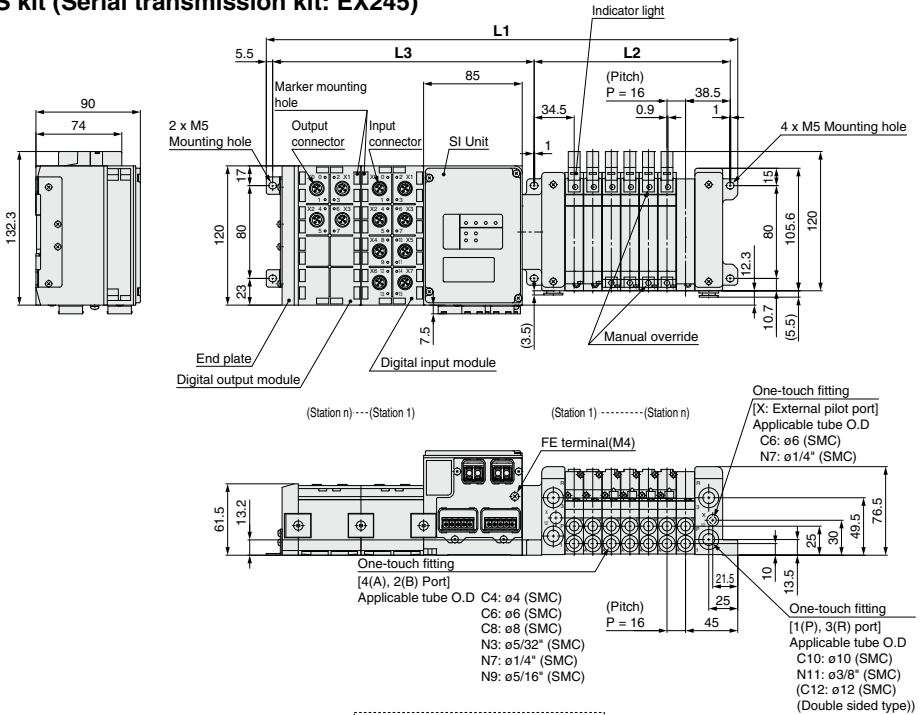

$L3 = 54n2 + 117.4$

L: Dimensions Formula: $L1 = 16n + 186.4$ $L2 = 16n 57$ * The L1 dimension is the dimension without an I/O module. Add 54 mm to this dimension for each I/O module. * n2 is the number of I/O module stations.

L \ n	1	2	3	4	5	6	7	8	9	10	11	12	13	14	15
L1	202.4	218.4	234.4	250.4	266.4	282.4	298.4	314.4	330.4	346.4	362.4	378.4	394.4	410.4	426.4
L2	73	89	105	121	137	153	169	185	201	217	233	249	265	281	297

L \ n	16	17	18	19	20	21	22	23	24
L1	442.4	458.4	474.4	490.4	506.4	522.4	538.4	554.4	570.4
L2	313	329	345	361	377	393	409	425	441

S VQC1000/2000 Series

Kit (Serial transmission) For EX250 Integrated-type (I/O) Serial Transmission System **IP67 compliant**

VV5QC11

S kit (Serial transmission kit: EX250)

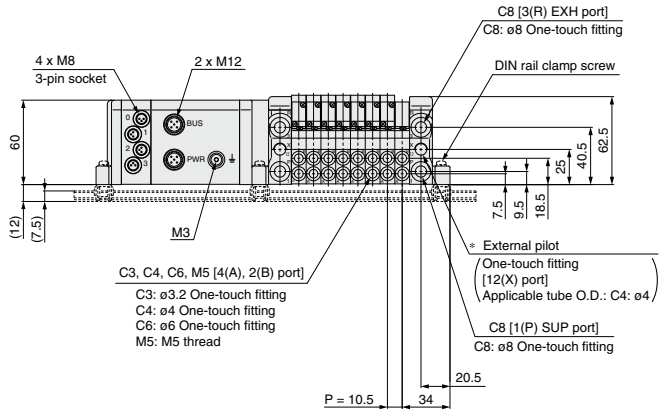
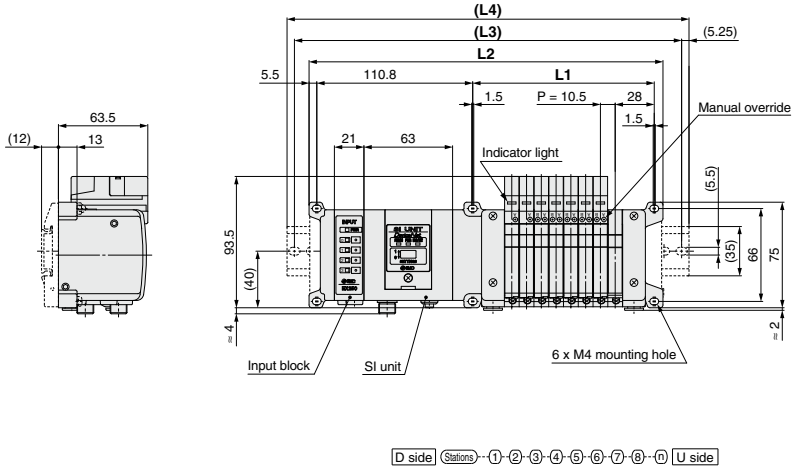

The dashed lines indicate DIN rail mounting [-D] (with DIN rail mounting bracket).

Formula: $L1 = 10.5n + 45$, $L2 = 10.5n + 167.5$ (For one input block. Add 21 mm for each additional input block.) n: Stations (Maximum 24 stations)

L \ n	1	2	3	4	5	6	7	8	9	10	11	12	13	14	15	16	17	18	19	20	21	22	23	24
L1	55.5	66	76.5	87	97.5	108	118.5	129	139.5	150	160.5	171	181.5	192	202.5	213	223.5	234	244.5	255	265.5	276	286.5	297
L2	178	188.5	199	209.5	220	230.5	241	251.5	262	272.5	283	293.5	304	314.5	325	335.5	346	356.5	367	377.5	388	398.5	409	419.5
L3	200	212.5	225	237.5	250	250	262.5	275	287.5	300	312.5	325	325	337.5	350	362.5	375	387.5	387.5	400	412.5	425	437.5	450
L4	210.5	223	235.5	248	260.5	260.5	273	285.5	298	310.5	323	335.5	335.5	348	360.5	373	385.5	398	398	410.5	423	435.5	448	460.5

VQC Series

S VQC1000 Series

Kit (Serial transmission) For EX260 Integrated-type (For Output) Serial Transmission System

IP40 compliant

IP67 compliant

VV5QC11

S kit (Serial transmission kit: EX260)

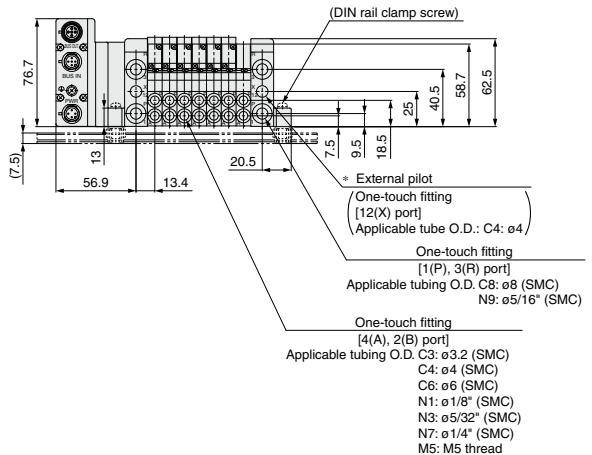
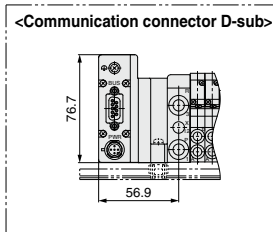
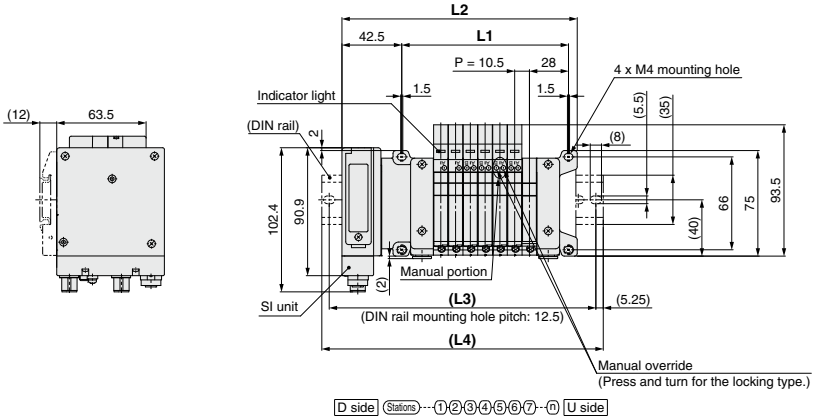

n: Stations (Maximum 24 stations)

L \ n	1	2	3	4	5	6	7	8	9	10	11	12	13	14	15	16	17	18	19	20	21	22	23	24
L1	55.5	66	76.5	87	97.5	108	118.5	129	139.5	150	160.5	171	181.5	192	202.5	213	223.5	234	244.5	255	265.5	276	286.5	297
L2	104.2	114.7	125.2	135.7	146.2	156.7	167.2	177.7	188.2	198.7	209.2	219.7	230.2	240.7	251.2	261.7	272.2	282.7	293.2	303.7	314.2	324.7	335.2	345.7
L3	125	137.5	150	162.5	175	187.5	187.5	200	212.5	225	237.5	250	250	262.5	275	287.5	300	312.5	325	325	337.5	350	362.5	375
L4	135.5	148	160.5	173	185.5	198	198	210.5	223	235.5	248	260.5	260.5	273	285.5	298	310.5	323	335.5	335.5	348	360.5	373	385.5

S VQC2000 Series
Kit (Serial transmission) For EX260 Integrated-type (For Output) Serial Transmission System

IP40 compliant

IP67 compliant

VV5QC21
S kit (Serial transmission kit: EX260)

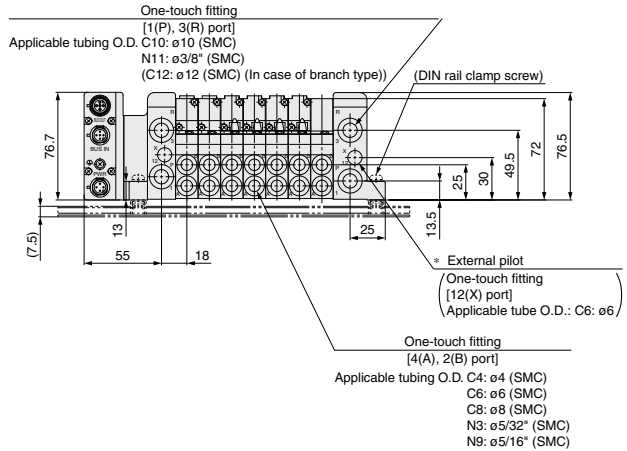
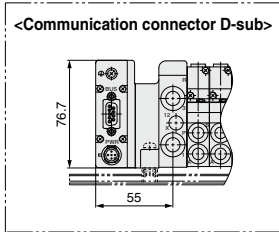
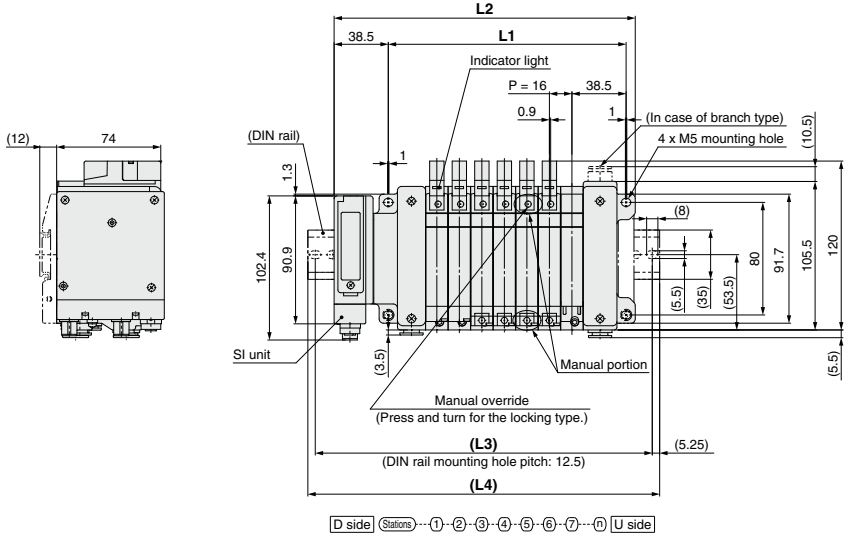

		n: Stations (Maximum 24 stations)																							
L \ n	1	2	3	4	5	6	7	8	9	10	11	12	13	14	15	16	17	18	19	20	21	22	23	24	
L1	73	89	105	121	137	153	169	185	201	217	233	249	265	281	297	313	329	345	361	377	393	409	425	441	
L2	118	134	150	166	182	198	214	230	246	262	278	294	310	326	342	358	374	390	406	422	438	454	470	486	
L3	137.5	162.5	175	187.5	212.5	225	237.5	250	275	287.5	300	325	337.5	350	362.5	387.5	400	412.5	437.5	450	462.5	475	500	512.5	
L4	148	173	185.5	198	223	235.5	248	260.5	285.5	298	310.5	335.5	348	360.5	373	398	410.5	423	448	460.5	473	485.5	510.5	523	

VQC Series

S VQC1000/2000 Series

Kit (Serial transmission) For EX250 Integrated-type (I/O) Serial Transmission System IP67 compliant

VV5QC21

S kit (Serial transmission kit: EX250)

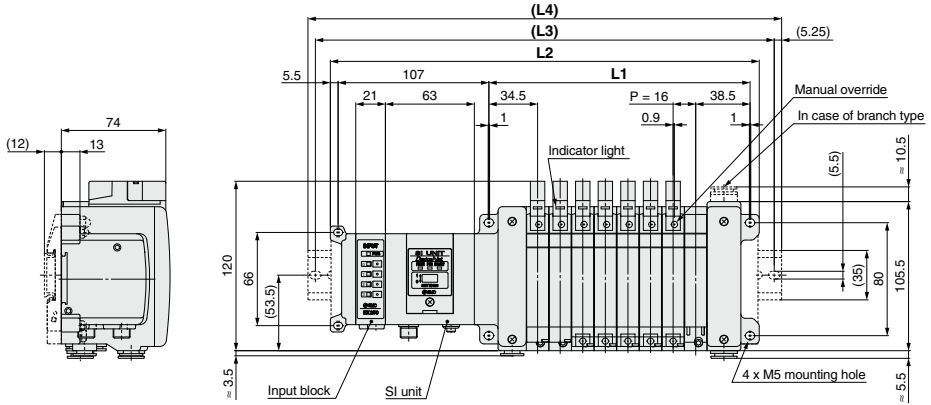

[D side Stations ①-②-③-④-⑤-⑥-⑦-⑧-⑨] [U side]

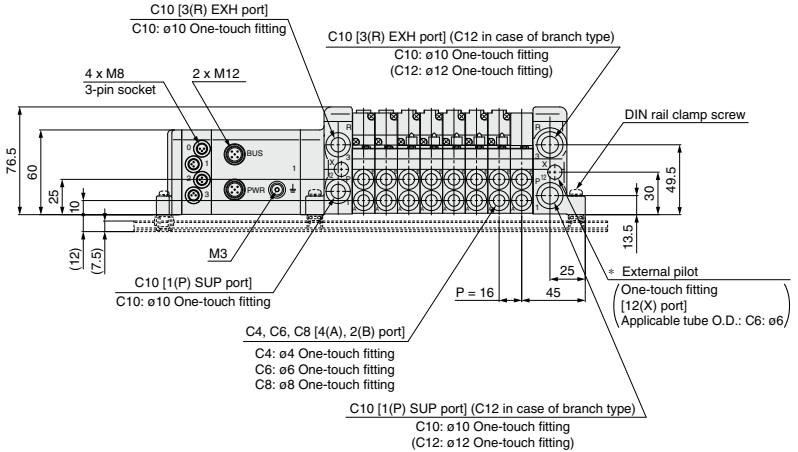

The dashed lines indicate DIN rail mounting [-D] (with DIN rail mounting bracket).

Formula: $L1 = 16n + 57$, $L2 = 16n + 176$ (For one input block. Add 21 mm for each additional input block.) n: Stations (Maximum 24 stations)

n	1	2	3	4	5	6	7	8	9	10	11	12	13	14	15	16	17	18	19	20	21	22	23	24
L1	73	89	105	121	137	153	169	185	201	217	233	249	265	281	297	313	329	345	361	377	393	409	425	441
L2	192	208	224	240	256	272	288	304	320	336	352	368	384	400	416	432	448	464	480	496	512	528	544	560
L3	212.5	237.5	250	262.5	275	287.5	312.5	325	337.5	362.5	375	387.5	400	425	437.5	450	462.5	487.5	500	512.5	537.5	550	562.5	587.5
L4	223	248	260.5	273	285.5	298	323	335.5	348	373	385.5	398	410.5	435.5	448	460.5	473	498	510.5	523	548	560.5	573	598

S VQC1000/2000 Series

Kit (Serial transmission) For EX126 Integrated-type (For Output) Serial Transmission System IP67 compliant

VV5QC11 S kit (Serial transmission kit: EX126)

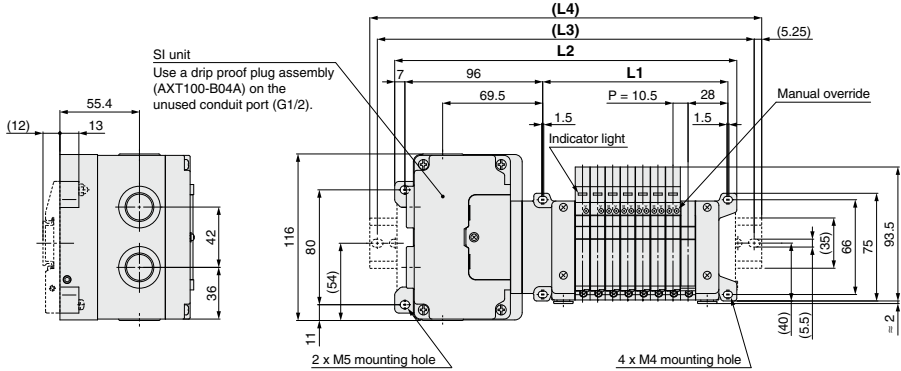

D side (Stations) ①-②-③-④-⑤-⑥-⑦-⑧-⑨-⑩ U side

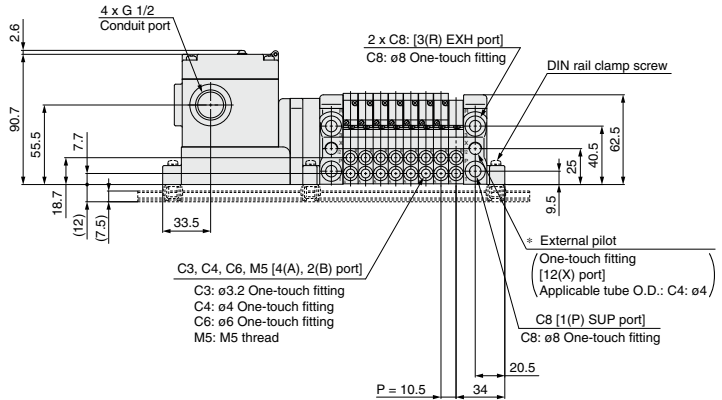

The dashed lines indicate DIN rail mounting [-D] (with DIN rail mounting bracket).

Formula: $L1 = 10.5n + 45$, $L2 = 10.5n + 154.5$ n: Stations (Maximum 16 stations)

L	n	1	2	3	4	5	6	7	8	9	10	11	12	13	14	15	16
L1		55.5	66	76.5	87	97.5	108	118.5	129	139.5	150	160.5	171	181.5	192	202.5	213
L2		165	175.5	186	196.5	207	217.5	228	238.5	249	259.5	270	280.5	291	301.5	312	322.5
L3		187.5	200	212.5	225	237.5	250	262.5	275	287.5	300	300	312.5	325	337.5	350	
L4		198	210.5	223	235.5	248	248	260.5	273	285.5	298	310.5	310.5	323	335.5	348	360.5

S VQC1000/2000 Series

Kit (Serial transmission) For EX126 Integrated-type (For Output) Serial Transmission System **IP67 compliant**

VV5QC21

S kit (Serial transmission kit: EX126)

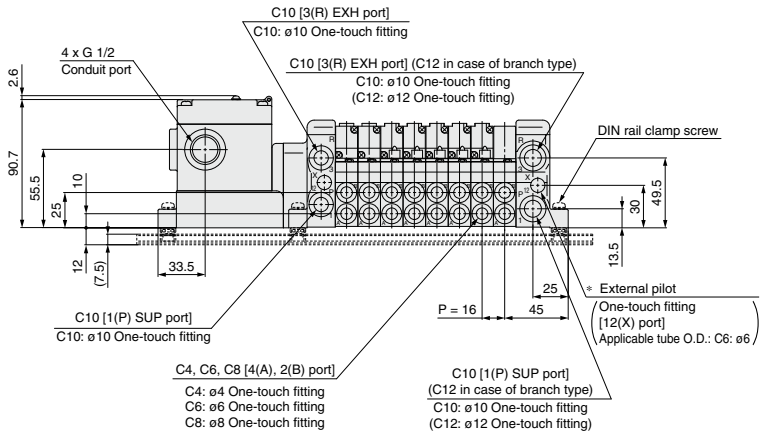
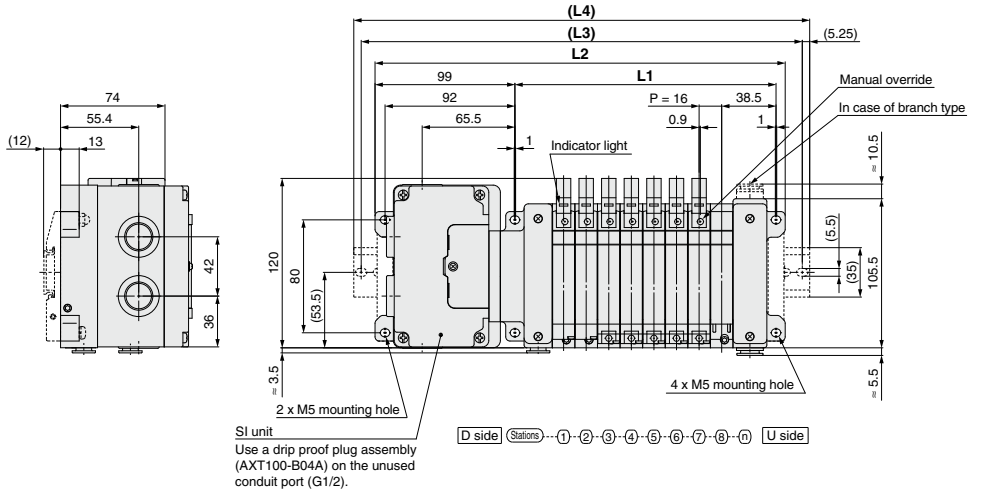

The dashed lines indicate DIN rail mounting [-D] (with DIN rail mounting bracket).

Formula: $L1 = 16n + 57$, $L2 = 16n + 163$ n: Stations (Maximum 16 stations)

L	n	1	2	3	4	5	6	7	8	9	10	11	12	13	14	15	16
L1		73	89	105	121	137	153	169	185	201	217	233	249	265	281	297	313
L2		179	195	211	227	243	259	275	291	307	323	339	355	371	387	403	419
L3		200	225	237.5	250	262.5	287.5	300	312.5	337.5	371	362.5	375	400	412.5	425	450
L4		210.5	235.5	248	260.5	273	298	310.5	323	348	360.5	373	385.5	410.5	423	435.5	460.5

VQC Series

F VQC1000/2000 Series Kit (D-sub connector) IP40 compliant

- Using our D-sub connector for electrical connections greatly reduces labor, while it also minimizes wiring and saves space.
- We use a D-sub connector (25P) that conforms to MIL standards and is therefore widely compatible with many standard commercial models.
- Top or side entry for the connector can be changed freely, allowing for changes even after mounting, to meet any changing needs for space.

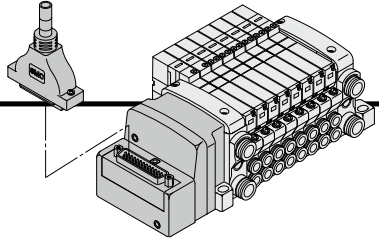

Electrical Wiring Specifications

D-sub connector

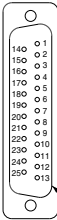

As the standard electrical wiring specifications, double wiring (connected to SOL. A and SOL. B) is adopted for the internal wiring of each station for 12 stations or less, regardless of valve and option types.
Mixed single and double wiring are available as an option. Refer to the below special wiring specifications (option).

Lead wire colors for D-sub connector assembly (AXT100-DS25-015/030/050)

Terminal no.	Polarity	Lead wire color	Dot marking
Station 1 SOL.A 1	(-)	(+) Black	None
Station 1 SOL.B 14	(+)	(-) Yellow	Black
Station 2 SOL.A 2	(-)	(+) Brown	None
Station 2 SOL.B 15	(+)	(-) Pink	Black
Station 3 SOL.A 3	(-)	(+) Red	None
Station 3 SOL.B 16	(+)	(-) Blue	White
Station 4 SOL.A 4	(-)	(+) Orange	None
Station 4 SOL.B 17	(+)	(-) Purple	None
Station 5 SOL.A 5	(-)	(+) Yellow	None
Station 5 SOL.B 18	(+)	(-) Gray	None
Station 6 SOL.A 6	(-)	(+) Pink	None
Station 6 SOL.B 19	(+)	(-) Orange	Black
Station 7 SOL.A 7	(-)	(+) Blue	None
Station 7 SOL.B 20	(+)	(-) Red	White
Station 8 SOL.A 8	(-)	(+) Purple	White
Station 8 SOL.B 21	(+)	(-) Brown	White
Station 9 SOL.A 9	(-)	(+) Gray	Black
Station 9 SOL.B 22	(+)	(-) Pink	Red
Station 10 SOL.A 10	(-)	(+) White	Black
Station 10 SOL.B 23	(+)	(-) Gray	Red
Station 11 SOL.A 11	(-)	(+) White	Red
Station 11 SOL.B 24	(+)	(-) Black	White
Station 12 SOL.A 12	(-)	(+) Yellow	Red
Station 12 SOL.B 25	(+)	(-) White	None
COM. 13	(+)	(-) Orange	Red

Note) When using the negative COM specification, use valves for negative COM.

Special Wiring Specifications (Option)

(25P)

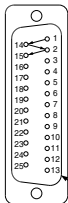

Mixed single and double wiring are available as an option. The maximum number of manifold stations is determined by the number of solenoids. Count one point for a single solenoid type and two points for a double solenoid type. The total number of solenoids (points) must not exceed 24.

Cable Assembly

AXT100-DS25-015/030/050

(D-sub connector cable assembly can be ordered with manifolds.)
Refer to "How to Order Manifold."

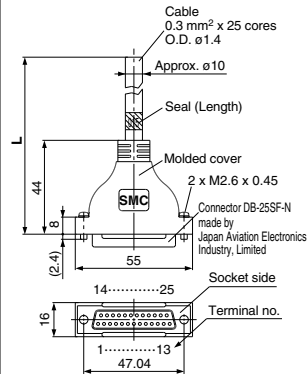

Lead wire colors for D-sub connector cable assembly terminal numbers

Terminal no.	Lead wire color	Dot marking
1	Black	None
2	Brown	None
3	Red	None
4	Orange	None
5	Yellow	None
6	Pink	None
7	Blue	None
8	Purple	White
9	Gray	Black
10	White	Black
11	White	Red
12	Yellow	Red
13	Orange	Red
14	Yellow	Black
15	Pink	Black
16	Blue	White
17	Purple	None
18	Gray	None
19	Orange	Black
20	Red	White
21	Brown	White
22	Pink	Red
23	Gray	Red
24	Black	White
25	White	None

D-sub connector cable assembly

Cable length (L)	Assembly part no.	Note
1.5 m	AXT100-DS25-015	Cable 0.3 mm² x 25 cores
3 m	AXT100-DS25-030	
5 m	AXT100-DS25-050	

- * When using a standard commercial connector, use a type 25P female connector conforming to MIL-C-24308.
- * Cannot be used for transfer wiring.
- * Lengths other than the above is also available. Please contact SMC for details.

Electrical characteristics

Item	Property
Conductor resistance Ω /km, 20°C	65 or less
Voltage limit V, 1 minute, AC	1000
Insulation resistance M Ω /km, 20°C	5 or more

Note) The minimum bending radius of the D-sub connector cable is 20 mm.

Connector Manufacturers' Example

- Fujitsu Limited
- Japan Aviation Electronics Industry, Limited
- J.S.T. Mfg. Co., Ltd.
- HIROSE ELECTRIC CO., LTD.

F VQC1000/2000 Series

Kit (D-sub connector) IP40 compliant

VV5QC11

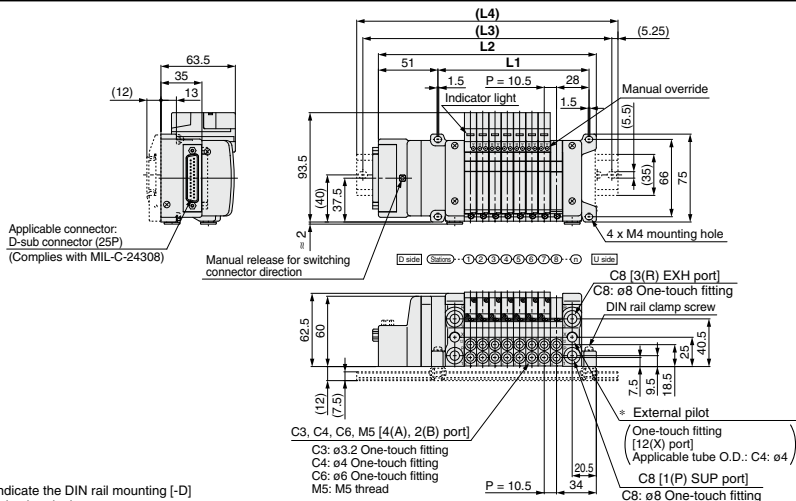

The dashed lines indicate the DIN rail mounting [-D] (with DIN rail mounting bracket).

Formula: $L1 = 10.5n + 45$, $L2 = 10.5n + 102$ n: Stations (Maximum 24 stations)

L	n	1	2	3	4	5	6	7	8	9	10	11	12	13	14	15	16	17	18	19	20	21	22	23	24
L1		55.5	66	76.5	87	97.5	108	118.5	129	139.5	150	160.5	171	181.5	192	202.5	213	223.5	234	244.5	255	265.5	276	286.5	297
L2		112.5	123	133.5	144	154.5	165	175.5	186	196.5	207	217.5	228	238.5	249	259.5	270	280.5	291	301.5	312	322.5	333	343.5	354
L3		137.5	150	162.5	175	175	187.5	200	212.5	225	237.5	237.5	250	262.5	275	287.5	300	300	312.5	325	337.5	350	362.5	375	375
L4		148	160.5	173	185.5	185.5	198	210.5	223	235.5	248	248	260.5	273	285.5	298	310.5	310.5	323	335.5	348	360.5	373	385.5	385.5

VV5QC21

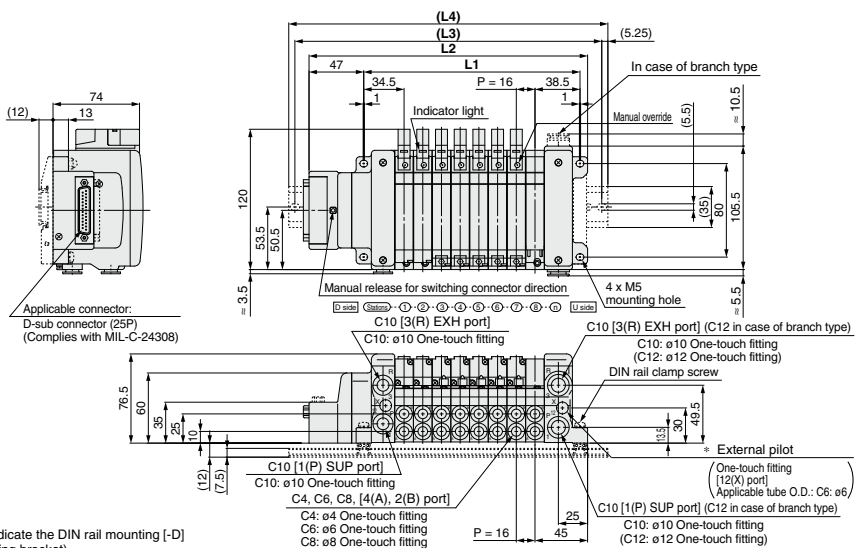

The dashed lines indicate the DIN rail mounting [-D] (with DIN rail mounting bracket).

Formula: $L1 = 16n + 57$, $L2 = 16n + 110.5$ n: Stations (Maximum 24 stations)

L	n	1	2	3	4	5	6	7	8	9	10	11	12	13	14	15	16	17	18	19	20	21	22	23	24
L1		73	89	105	121	137	153	169	185	201	217	233	249	265	281	297	313	329	345	361	377	393	409	425	441
L2		126.5	142.5	158.5	174.5	190.5	206.5	222.5	238.5	254.5	270.5	286.5	302.5	318.5	334.5	350.5	366.5	382.5	398.5	414.5	430.5	446.5	462.5	478.5	494.5
L3		150	162.5	187.5	200	212.5	237.5	250	262.5	275	300	312.5	325	350	362.5	375	387.5	412.5	425	437.5	450	475	487.5	500	525
L4		160.5	173	198	210.5	223	248	260.5	273	285.5	310.5	323	335.5	360.5	373	385.5	398	423	435.5	448	460.5	485.5	498	510.5	535.5

VQC Series

P VQC1000/2000 Series Kit (Flat ribbon cable) IP40 compliant

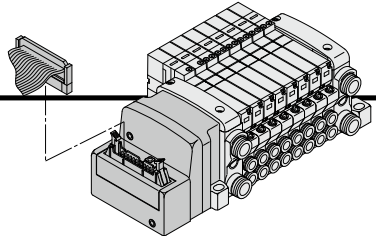

- Using our flat ribbon cable for electrical connections greatly reduces labor, while it also minimizes wiring and saves space.
- We use flat ribbon cables whose connectors (26P and 20P) conform to MIL standards, and are therefore widely compatible with many standard commercial models.
- Top or side entry for the connector can be changed freely, allowing for changes even after mounting, to meet any changing needs for space.

Electrical Wiring Specifications

Flat ribbon cable connector

Double wiring (connected to SOL. A and SOL. B) is adopted for the internal wiring of each station, regardless of valve and option types. Mixed single and double wiring are available as an option. Refer to the below special wiring specifications (option).

Connector terminal number

Triangle mark indicator position

<26P>		<20P>	
Terminal no.	Polarity	Terminal no.	Polarity
Station 1	SOL.A 1 (+)	Station 1	SOL.A 1 (-)
	SOL.B 2 (+)		SOL.B 2 (-)
Station 2	SOL.A 3 (-)	Station 2	SOL.A 3 (+)
	SOL.B 4 (-)		SOL.B 4 (+)
Station 3	SOL.A 5 (+)	Station 3	SOL.A 5 (-)
	SOL.B 6 (+)		SOL.B 6 (-)
Station 4	SOL.A 7 (-)	Station 4	SOL.A 7 (+)
	SOL.B 8 (-)		SOL.B 8 (+)
Station 5	SOL.A 9 (+)	Station 5	SOL.A 9 (-)
	SOL.B 10 (+)		SOL.B 10 (-)
Station 6	SOL.A 11 (-)	Station 6	SOL.A 11 (+)
	SOL.B 12 (-)		SOL.B 12 (+)
Station 7	SOL.A 13 (+)	Station 7	SOL.A 13 (-)
	SOL.B 14 (+)		SOL.B 14 (-)
Station 8	SOL.A 15 (-)	Station 8	SOL.A 15 (+)
	SOL.B 16 (-)		SOL.B 16 (+)
Station 9	SOL.A 17 (+)	Station 9	SOL.A 17 (-)
	SOL.B 18 (+)		SOL.B 18 (-)
Station 10	SOL.A 19 (-)		COM. 19 (+)
	SOL.B 20 (-)		COM. 20 (+)
Station 11	SOL.A 21 (+)		
	SOL.B 22 (+)		
Station 12	SOL.A 23 (-)		
	SOL.B 24 (-)		
	COM. 25 (+)		
	COM. 26 (-)		

Note) Positive COM spec. Negative COM spec.

Note) When using the negative COM specification, use valves for negative COM.

Cable Assembly

AXT100-FC $\begin{matrix} 20 \\ 26 \\ 3 \end{matrix}$

(Type 26P flat ribbon cable connector assembly can be ordered with manifolds. Refer to "How to Order Manifold.")

Terminal no. Red 28AWG

30 (20P) 37.5 (26P)

6

2

1

23

(15.6)

L

Flat ribbon cable connector assembly

Cable length (L)	Assembly part no.	
	26P	20P
1.5 m	AXT100-FC26-1	AXT100-FC20-1
3 m	AXT100-FC26-2	AXT100-FC20-2
5 m	AXT100-FC26-3	AXT100-FC20-3

- When using a standard commercial connector, use a type 26P connector conforming to MIL-C-83503 or a type 20P with strain relief.
- Cannot be used for transfer wiring.
- Lengths other than the above is also available. Please contact SMC for details.

Connector Manufacturers' Example

- HIROSE ELECTRIC CO., LTD.
- 3M Japan Limited
- Fujitsu Limited
- Japan Aviation Electronics Industry, Limited
- J.S.T. Mfg. Co., Ltd.
- Oki Electric Cable Co., Ltd.

Special Wiring Specifications (Option)

COM

COM

COM

COM

26 □ 25
24 □ 23
22 □ 21
20 □ 19
18 □ 17
16 □ 15
14 □ 13
12 □ 11
10 □ 9
8 □ 7
6 □ 5
4 □ 3
2 □ 1

(26P)

20 □ 19
18 □ 17
16 □ 15
14 □ 13
12 □ 11
10 □ 9
8 □ 7
6 □ 5
4 □ 3
2 □ 1

(20P)

Mixed single and double wiring are available as an option. The maximum number of manifold stations is determined by the number of solenoids. Count one point for a single solenoid type and two points for a double solenoid type. The total number of solenoids (points) must not exceed 24.

P VQC1000/2000 Series

Kit (Flat ribbon cable) IP40 compliant

VV5QC11

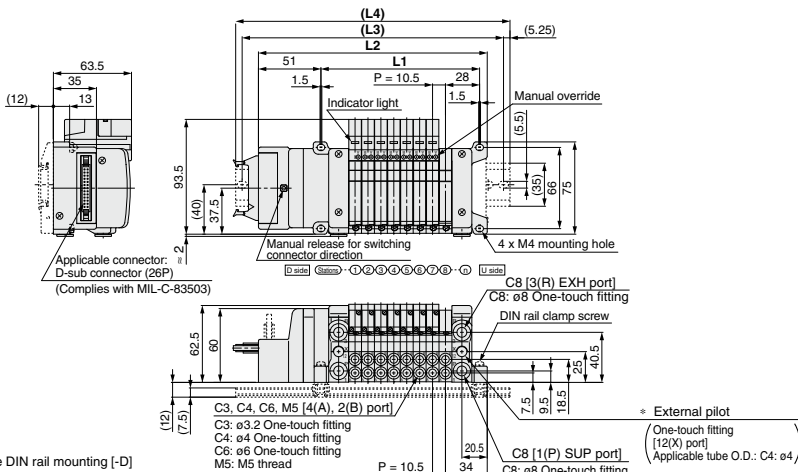

The dashed lines indicate the DIN rail mounting [-D] (with DIN rail mounting bracket).

Formula: $L1 = 10.5n + 45$, $L2 = 10.5n + 102$ n: Stations (Maximum 24 stations)

L	n	1	2	3	4	5	6	7	8	9	10	11	12	13	14	15	16	17	18	19	20	21	22	23	24
L1		55.5	66	76.5	87	97.5	108	118.5	129	139.5	150	160.5	171	181.5	192	202.5	213	223.5	234	244.5	255	265.5	276	286.5	297
L2		112.5	123	133.5	144	154.5	165	175.5	186	196.5	207	217.5	228	238.5	249	259.5	270	280.5	291	301.5	312	322.5	333	343.5	354
L3		137.5	150	162.5	175	175	187.5	200	212.5	225	237.5	237.5	250	262.5	275	287.5	300	300	312.5	325	337.5	350	362.5	375	375
L4		148	160.5	173	185.5	185.5	198	210.5	223	235.5	248	248	260.5	273	285.5	298	310.5	310.5	323	335.5	348	360.5	373	385.5	385.5

VV5QC21

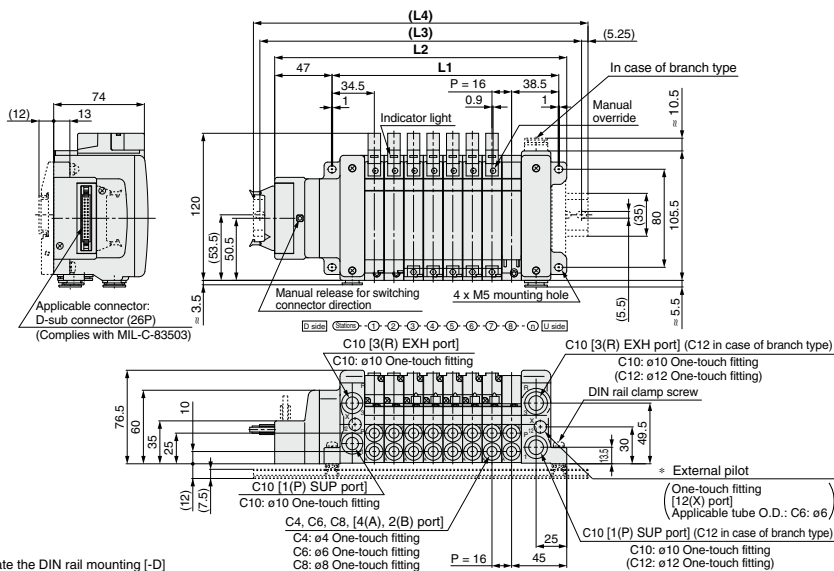

The dashed lines indicate the DIN rail mounting [-D] (with DIN rail mounting bracket).

Formula: $L1 = 16n + 57$, $L2 = 16n + 110.5$ n: Stations (Maximum 24 stations)

L	n	1	2	3	4	5	6	7	8	9	10	11	12	13	14	15	16	17	18	19	20	21	22	23	24
L1		73	89	105	121	137	153	169	185	201	217	233	249	265	281	297	313	329	345	361	377	393	409	425	441
L2		126.5	142.5	158.5	174.5	190.5	206.5	222.5	238.5	254.5	270.5	286.5	302.5	318.5	334.5	350.5	366.5	382.5	398.5	414.5	430.5	446.5	462.5	478.5	494.5
L3		150	162.5	187.5	200	212.5	237.5	250	262.5	275	300	312.5	325	350	362.5	375	387.5	412.5	425	437.5	450	475	487.5	500	525
L4		160.5	173	198	210.5	223	248	260.5	273	285.5	310.5	323	335.5	360.5	373	385.5	398	423	435.5	448	460.5	485.5	498	510.5	535.5

VQC Series

T VQC1000/2000 Series Kit (Terminal block box) IP67 compliant

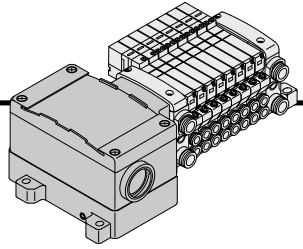

- This kit has a small terminal block inside a junction box. The electrical entry port of a G 3/4 permits connection of conduit fittings.

Terminal Block Connection

Step 1. Removing the terminal block cover

Loosen the 4 mounting screws (M4) and remove the terminal block cover.

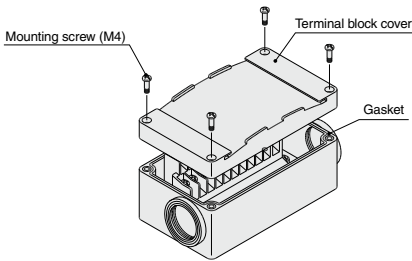

Step 3. Mounting the terminal block cover

Securely tighten the screws to the torque shown in the table below, after confirming that the gasket is installed correctly.

Proper tightening torque (N·m)
0.7 to 1.2

- Applicable crimped terminal: 1.25-3S, 1.25Y-3, 1.25Y-3N, 1.25Y-3.5
- Name plate: VVQ5000-N-T
- Drip-proof plug assembly (for G 3/4): AXT100-B06A

Step 2. The diagram below shows the terminal block wiring.

All stations are provided with double wiring regardless of the valves which are mounted.

Connect each wire to the power supply side, according to the markings provided inside the terminal block.

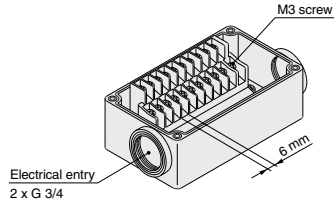

Electrical Wiring Specifications (IP67 compatible)

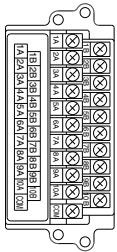

Double wiring (connected to SOL. A and SOL. B) is adopted for the internal wiring of each station, regardless of valve and option types. Mixed single and double wiring are available as an option.

Note) When using the negative COM specification, use valves for negative COM.

Standard wiring

	Terminal no.	Polarity
Station 1	SOL.A	1A (-) (+)
	SOL.B	1B (-) (+)
Station 2	SOL.A	2A (-) (+)
	SOL.B	2B (-) (+)
Station 3	SOL.A	3A (-) (+)
	SOL.B	3B (-) (+)
Station 4	SOL.A	4A (-) (+)
	SOL.B	4B (-) (+)
Station 5	SOL.A	5A (-) (+)
	SOL.B	5B (-) (+)
Station 6	SOL.A	6A (-) (+)
	SOL.B	6B (-) (+)
Station 7	SOL.A	7A (-) (+)
	SOL.B	7B (-) (+)
Station 8	SOL.A	8A (-) (+)
	SOL.B	8B (-) (+)
Station 9	SOL.A	9A (-) (+)
	SOL.B	9B (-) (+)
Station 10	SOL.A	10A (-) (+)
	SOL.B	10B (-) (+)
	COM	(+) (-) Note)

Positive COM spec. Negative COM spec.

Special Wiring Specifications (Option)

Mixed single and double wiring are available as an option. The maximum number of manifold stations is determined by the number of solenoids. Count one point for a single solenoid type and two points for a double solenoid type. The total number of solenoids (points) must not exceed 20.

1. How to Order

Indicate option symbol "K" in the manifold part number and be sure to specify station positions for single or double wiring on the manifold specification sheet.

2. Wiring specifications

Connector terminal numbers are connected from solenoid station 1 on the A side in the order indicated by the arrows without skipping any terminal numbers.



T VQC1000/2000 Series

Kit (Terminal block box) IP67 compliant

VV5QC11

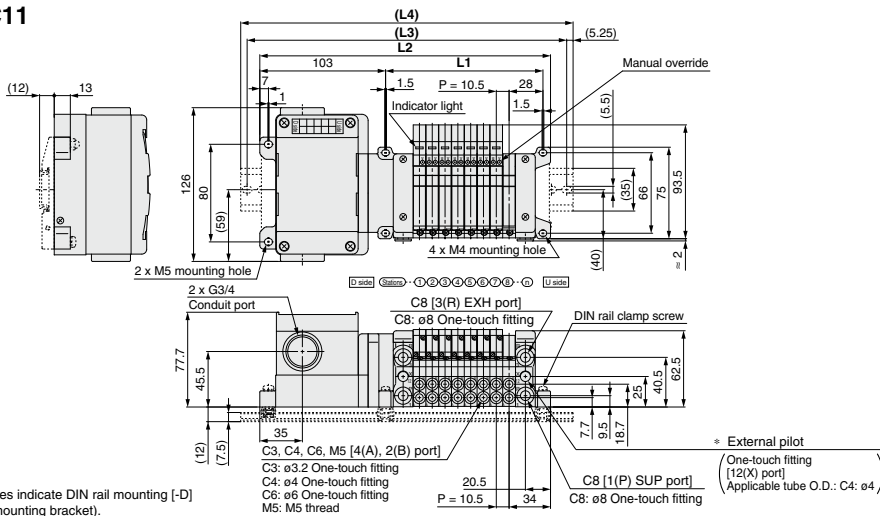

The dashed lines indicate DIN rail mounting [-D] (with DIN rail mounting bracket).

L \ n	1	2	3	4	5	6	7	8	9	10	11	12	13	14	15	16	17	18	19	20
L1	55.5	66	76.5	87	97.5	108	118.5	129	139.5	150	160.5	171	181.5	192	202.5	213	223.5	234	244.5	255
L2	165	175.5	186	196.5	207	217.5	228	238.5	249	259.5	270	280.5	291	301.5	312	322.5	333	343.5	354	364.5
L3	187.5	200	212.5	225	237.5	250	262.5	275	287.5	300	300	312.5	325	337.5	350	362.5	375	375	387.5	
L4	198	210.5	223	235.5	248	260.5	273	285.5	298	310.5	310.5	323	335.5	348	360.5	373	385.5	385.5	398	

VV5QC21

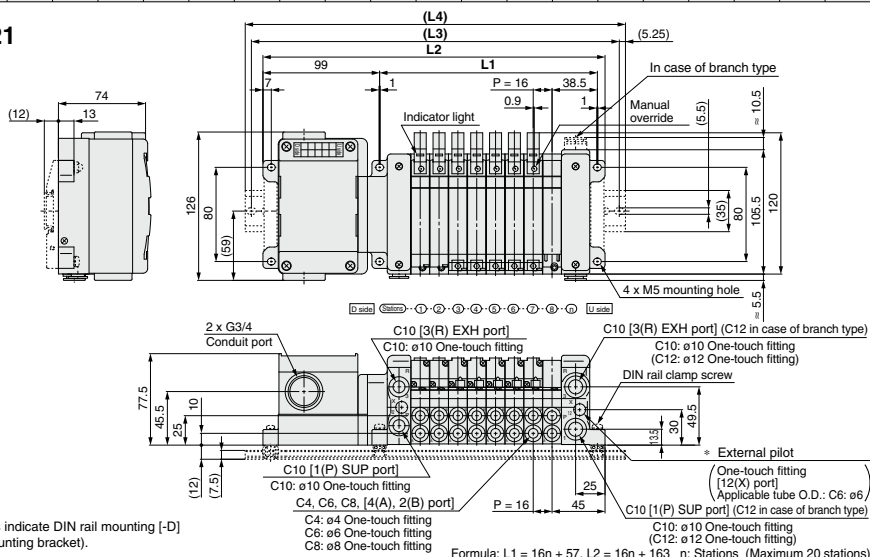

The dashed lines indicate DIN rail mounting [-D] (with DIN rail mounting bracket).

L \ n	1	2	3	4	5	6	7	8	9	10	11	12	13	14	15	16	17	18	19	20
L1	73	89	105	121	137	153	169	185	201	217	233	249	265	281	297	313	329	345	361	377
L2	179	195	211	227	243	259	275	291	307	323	339	355	371	387	403	419	435	451	467	483
L3	200	225	237.5	250	262.5	287.5	300	312.5	337.5	371	362.5	375	400	412.5	425	450	462.5	496	487.5	512.5
L4	210.5	235.5	248	260.5	273	298	310.5	323	348	360.5	373	385.5	410.5	423	435.5	460.5	473	485.5	498	523

VQC Series

VQC1000/2000 Series Kit (Lead wire) IP67 compliant

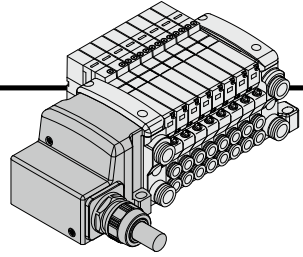

- Direct electrical entry type
- IP67 enclosure is available with use of cables with sheath and waterproof connectors.

Electrical Wiring Specifications

Lead wire specifications

Lead wire

0.3 mm² x 25 cores

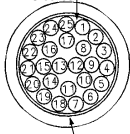

Sheath
Color: White

As the standard electrical wiring specifications, double wiring (connected to SOL. A and SOL. B) is adopted for the internal wiring of each station for 12 stations or less, regardless of valve and option types.

Mixed single and double wiring are available as an option. Refer to the below special wiring specifications (option).

	Terminal no.	Polarity	Lead wire color	Dot marking
Station 1	SOL.A 1	(-)	(+)	Black None
	SOL.B 14	(-)	(+)	Yellow Black
Station 2	SOL.A 2	(-)	(+)	Brown None
	SOL.B 15	(-)	(+)	Pink Black
Station 3	SOL.A 3	(-)	(+)	Red None
	SOL.B 16	(-)	(+)	Blue White
Station 4	SOL.A 4	(-)	(+)	Orange None
	SOL.B 17	(-)	(+)	Purple None
Station 5	SOL.A 5	(-)	(+)	Yellow None
	SOL.B 18	(-)	(+)	Gray None
Station 6	SOL.A 6	(-)	(+)	Pink None
	SOL.B 19	(-)	(+)	Orange Black
Station 7	SOL.A 7	(-)	(+)	Blue None
	SOL.B 20	(-)	(+)	Red White
Station 8	SOL.A 8	(-)	(+)	Purple White
	SOL.B 21	(-)	(+)	Brown White
Station 9	SOL.A 9	(-)	(+)	Gray Black
	SOL.B 22	(-)	(+)	Pink Red
Station 10	SOL.A 10	(-)	(+)	White Black
	SOL.B 23	(-)	(+)	Gray Red
Station 11	SOL.A 11	(-)	(+)	White Red
	SOL.B 24	(-)	(+)	Black White
Station 12	SOL.A 12	(-)	(+)	Yellow Red
	SOL.B 25	(-)	(+)	White None
	COM. 13	(+)	(-)	Orange Red

Positive COM spec. Negative COM spec. (Note)

Note) When using the negative COM specification, use valves for negative COM.

Lead wire length

VV5QC11-08C6LD0

Lead wire length

0	0.6 m
1	1.5 m
2	3.0 m

Electrical characteristics

Item	Property
Conductor resistance Ω/km, 20°C	65 or less
Voltage limit V, 1 minute, AC	1000
Insulation resistance MΩ/km, 20°C	5 or more

Note) Cannot be used for transfer wiring.
The minimum bending radius of the cable is 20 mm.

Special Wiring Specifications (Option)

Mixed single and double wiring are available as an option. The maximum number of manifold stations is determined by the number of solenoids. Count one point for a single solenoid type and two points for a double solenoid type. The total number of solenoids (points) must not exceed 24.

VQC1000/2000 Series

Kit (Lead wire) IP67 compliant

VV5QC11

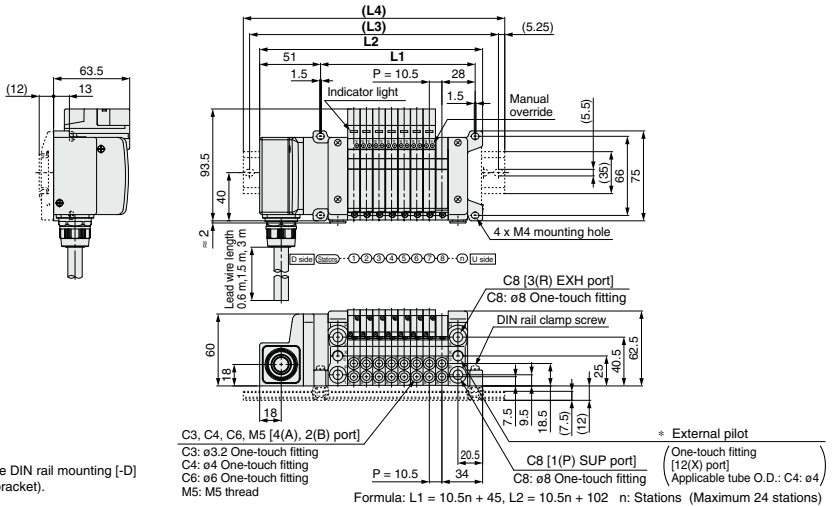

The dashed lines indicate DIN rail mounting [-D] (with DIN rail mounting bracket).

L	n	1	2	3	4	5	6	7	8	9	10	11	12	13	14	15	16	17	18	19	20	21	22	23	24
L1		55.5	66	76.5	87	97.5	108	118.5	129	139.5	150	160.5	171	181.5	192	202.5	213	223.5	234	244.5	255	265.5	276	286.5	297
L2		112.5	123	133.5	144	154.5	165	175.5	186	196.5	207	217.5	228	238.5	249	259.5	270	280.5	291	301.5	312	322.5	333	343.5	354
L3		137.5	150	162.5	175	187.5	200	212.5	225	237.5	250	262.5	275	287.5	300	312.5	325	337.5	350	362.5	375	387.5	400	412.5	425
L4		148	160.5	173	185.5	198	210.5	223	235.5	248	260.5	273	285.5	298	310.5	323	335.5	348	360.5	373	385.5	398.5	411.5	424.5	437.5

VV5QC21

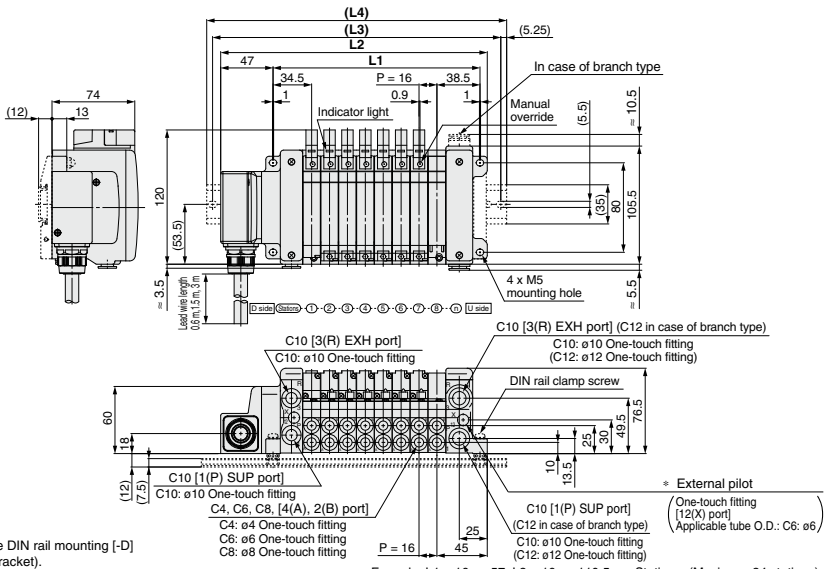

The dashed lines indicate DIN rail mounting [-D] (with DIN rail mounting bracket).

L	n	1	2	3	4	5	6	7	8	9	10	11	12	13	14	15	16	17	18	19	20	21	22	23	24
L1		73	89	105	121	137	153	169	185	201	217	233	249	265	281	297	313	329	345	361	377	393	409	425	441
L2		126.5	142.5	158.5	174.5	190.5	206.5	222.5	238.5	254.5	270.5	286.5	302.5	318.5	334.5	350.5	366.5	382.5	398.5	414.5	430.5	446.5	462.5	478.5	494.5
L3		150	162.5	187.5	200	212.5	237.5	250	262.5	275	300	312.5	325	350	362.5	375	387.5	412.5	425	437.5	450	475	487.5	500	525
L4		160.5	173	198	210.5	223	248	260.5	273	285.5	310.5	323	335.5	360.5	373	385.5	398	423	435.5	448	460.5	485.5	498	510.5	535.5

VQC Series

M VQC1000/2000 Series Kit (Circular connector) IP67 compliant

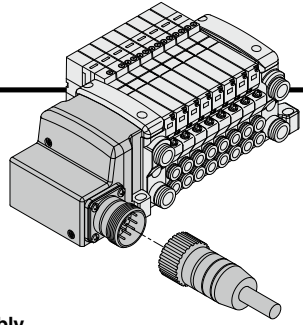

- Use of circular connectors helps streamline wiring procedure to save labor.
- IP67 enclosure is available with use of waterproof circular connectors.

Electrical Wiring Specifications

Circular connector

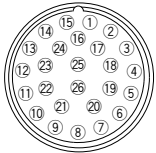

Double wiring (connected to SOL.A and SOL.B) is used for the internal wiring of each station, regardless of valve and option types. Mixed single and double wiring are available as an option. Refer to the below special wiring specifications (option).

Station	Terminal no.	SOL.A	SOL.B	Polarity	COM spec.
Station 1	1	(-)	(+)		
	2	(-)	(+)		
Station 2	3	(-)	(+)		
	4	(-)	(+)		
Station 3	5	(-)	(+)		
	6	(-)	(+)		
Station 4	7	(-)	(+)		
	8	(-)	(+)		
Station 5	9	(-)	(+)		
	10	(-)	(+)		
Station 6	11	(-)	(+)		
	12	(-)	(+)		
Station 7	13	(-)	(+)		
	14	(-)	(+)		
Station 8	15	(-)	(+)		
	16	(-)	(+)		
Station 9	17	(-)	(+)		
	18	(-)	(+)		
Station 10	19	(-)	(+)		
	20	(-)	(+)		
Station 11	21	(-)	(+)		
	22	(-)	(+)		
Station 12	23	(-)	(+)		
	24	(-)	(+)		
COM.	25	(+)	(-)		
	26	(+)	(-)		

(Note)
Positive COM spec. Negative COM spec.

Note) When using the negative COM specification, use valves for negative COM.

Special Wiring Specifications (Option)

Mixed single and double wiring are available as an option. The maximum number of manifold stations is determined by the number of solenoids. Count one point for a single solenoid type and two points for a double solenoid type. The total number of solenoids (points) must not exceed 24.

Cable Assembly

AXT100-MC26-030
015
050

(Type 26P circular connector cable assembly can be ordered with manifolds. Refer to "How to Order Manifold.")

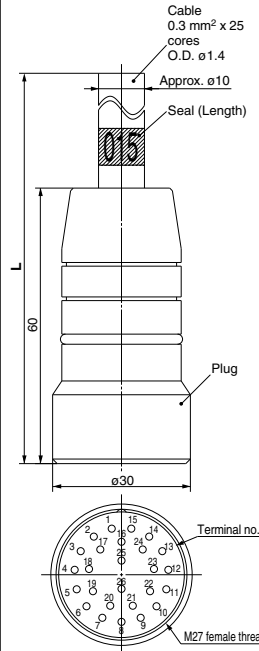

Lead wire colors for circular connector cable assembly terminal numbers

Terminal no.	Lead wire color	Dot marking
1	Black	None
2	Brown	None
3	Red	None
4	Orange	None
5	Yellow	None
6	Pink	None
7	Blue	None
8	Purple	White
9	Gray	Black
10	White	Black
11	White	Red
12	Yellow	Red
13	Orange	Red
14	Yellow	Black
15	Pink	Black
16	Blue	White
17	Purple	None
18	Gray	None
19	Orange	Black
20	Red	White
21	Brown	White
22	Pink	Red
23	Gray	Red
24	Black	White
25	White	None
26	White	None

Note) Terminal no. 26 is connected to 26 inside the connector.

Electrical characteristics

Item	Property
Conductor resistance Ω/km, 20°C	65 or less
Voltage limit V, 1 minute, AC	1000
Insulation resistance MΩ/km, 20°C	5 or more

Note) The minimum bending radius of the circular connector cable is 20 mm.

Circular connector cable assembly

Cable length (L)	Assembly part no.
1.5 m	AXT100-MC26-015
3 m	AXT100-MC26-030
5 m	AXT100-MC26-050

- * Cannot be used for transfer wiring.
- * Lengths other than the above is also available. Please contact SMC for details.

VQC1000/2000 Series Construction

VQC1000 Plug-in Unit: Main Parts/Replacement Parts

Metal seal

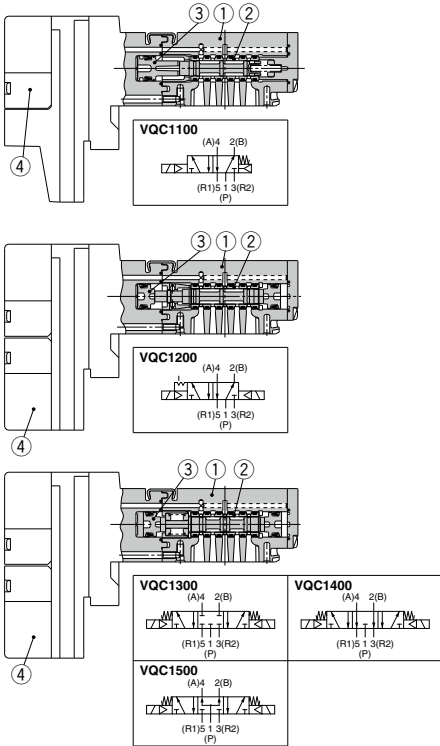

Rubber seal

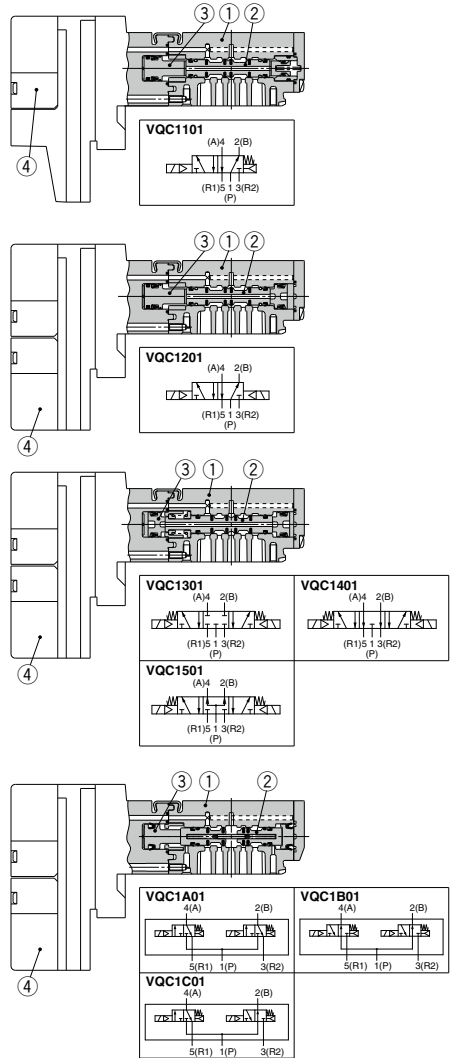

Component Parts

No.	Description	Material	Note
1	Body	Zinc die-casted	
2	Spool/Sleeve	Stainless steel	
3	Piston	Resin	
4	Pilot valve assembly	—	

Note) Refer to page 1133 for "How to Order Pilot Valve Assembly."

Component Parts

No.	Description	Material	Note
1	Body	Zinc die-casted	
2	Spool valve	Aluminum, HNBR	
3	Piston	Resin	
4	Pilot valve assembly	—	

Note) Refer to page 1133 for "How to Order Pilot Valve Assembly."

VQC2000 Plug-in Unit: Main Parts/Replacement Parts

Metal seal

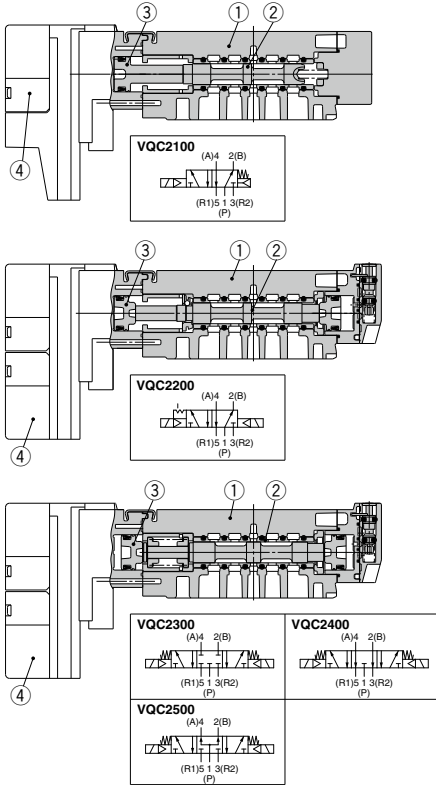

Rubber seal

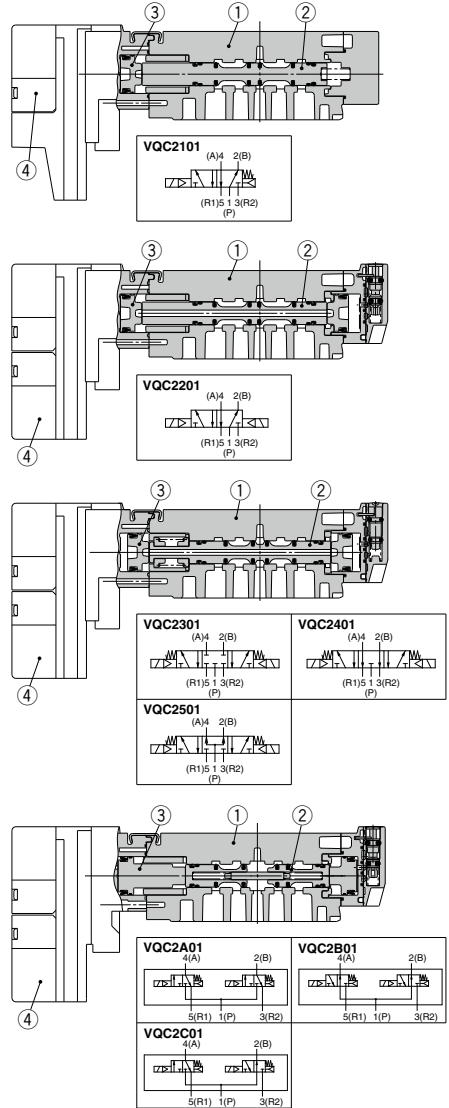

Component Parts

No.	Description	Material	Note
1	Body	Zinc die-casted	
2	Spool/Sleeve	Stainless steel	
3	Piston	Resin	
4	Pilot valve assembly	—	

Note) Refer to page 1133 for "How to Order Pilot Valve Assembly."

Component Parts

No.	Description	Material	Note
1	Body	Zinc die-casted	
2	Spool valve	Aluminum, HNBR	
3	Piston	Resin	
4	Pilot valve assembly	—	

Note) Refer to page 1133 for "How to Order Pilot Valve Assembly."

VQC1000/2000 Series

Exploded View of Manifold

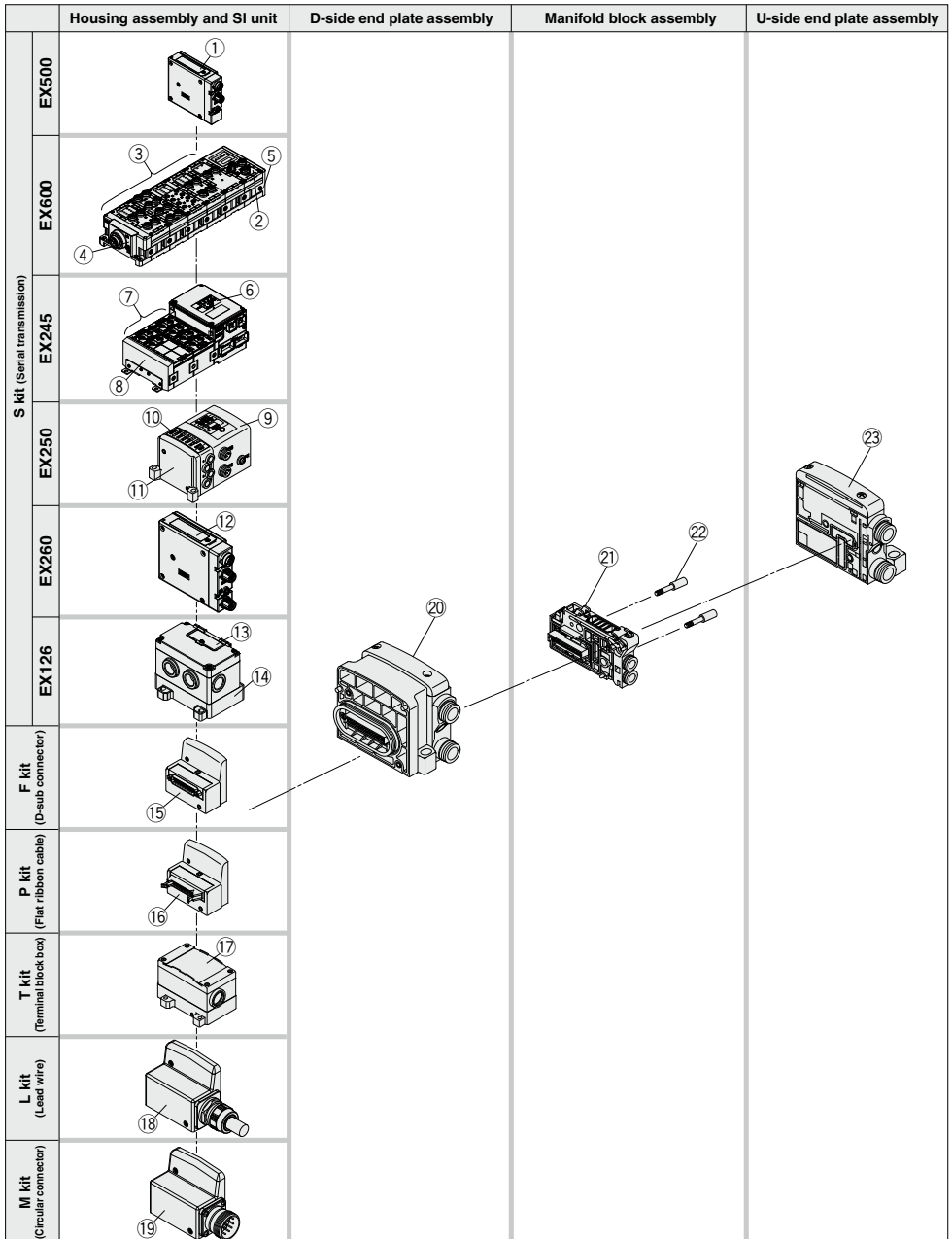

Manifold Assembly Part No.**Housing Assembly and SI Unit/Input Block**

No.	Description	Part no.	Note	
①	SI unit	EX600-S103	Gateway decentralized system 2 (128 points), PNP (Negative common)	
②	SI unit	EX600-SDN1A	DeviceNet® PNP (Negative common)	
		EX600-SDN2A	DeviceNet® NPN (Positive common)	
		EX600-SMJ1	CC-Link PNP (Negative common)	
		EX600-SMJ2	CC-Link NPN (Positive common)	
		EX600-SPR1A	PROFIBUS DP PNP (Negative common)	
		EX600-SPR2A	PROFIBUS DP NPN (Positive common)	
		EX600-SEN7	EtherNet/IP™ (IO-Link unit) PNP (Negative common)	
		EX600-SEN8	EtherNet/IP™ (IO-Link unit) NPN (Positive common)	
		EX600-SEC3	EtherCAT (IO-Link unit) PNP (Negative common)	
		EX600-SEC4	EtherCAT (IO-Link unit) NPN (Positive common)	
		EX600-SPN3	PROFINET (IO-Link unit) PNP (Negative common)	
		EX600-SPN4	PROFINET (IO-Link unit) NPN (Positive common)	
		EX600-SPN31	PROFINET (OPC UA, IO-Link unit) PNP (Negative common)	
		EX600-WEN1	Wireless base module EtherNet/IP™ PNP (Negative common)	
		EX600-WEN2	Wireless base module EtherNet/IP™ NPN (Positive common)	
		EX600-WPN1	Wireless base module PROFINET PNP (Negative common)	
		EX600-WPN2	Wireless base module PROFINET NPN (Positive common)	
		EX600-WSV1	Wireless remote module PNP (Negative common)	
		EX600-WSV2	Wireless remote module NPN (Positive common)	
		③	Digital input unit	EX600-DXNB
EX600-DXPB	PNP input, M12 connector, 5 pins (4 pcs.), 8 inputs			
EX600-DXNC	NPN input, M8 connector, 3 pins (8 pcs.), 8 inputs			
EX600-DXNC1	NPN input, M8 connector, 3 pins (8 pcs.), 8 inputs, with open circuit detection			
EX600-DXPC	PNP input, M8 connector, 3 pins (8 pcs.), 8 inputs			
EX600-DXPC1	PNP input, M8 connector, 3 pins (8 pcs.), 8 inputs, with open circuit detection			
EX600-DXND	NPN input, M12 connector, 5 pins (8 pcs.), 16 inputs			
EX600-DXPD	PNP input, M12 connector, 5 pins (8 pcs.), 16 inputs			
EX600-DXNE	NPN input, D-sub connector, 25 pins, 16 inputs			
EX600-DXPE	PNP input, D-sub connector, 25 pins, 16 inputs			
EX600-DXNF	NPN input, Spring type terminal box, 32 pins, 16 inputs			
EX600-DXPF	PNP input, Spring type terminal box, 32 pins, 16 inputs			
Digital output unit	EX600-DYNB		NPN output, M12 connector, 5 pins (4 pcs.), 8 outputs	
	EX600-DYPB		PNP output, M12 connector, 5 pins (4 pcs.), 8 outputs	
	EX600-DYNE		NPN output, D-sub connector, 25 pins, 16 outputs	
	EX600-DYPE		PNP output, D-sub connector, 25 pins, 16 outputs	
	EX600-DYNF		NPN output, Spring type terminal box, 32 pins, 16 outputs	
	EX600-DYPF		PNP output, Spring type terminal box, 32 pins, 16 outputs	
	Digital input/output unit		EX600-DMNE	NPN input/output, D-sub connector, 25 pins, 8 inputs/outputs
			EX600-DMPE	PNP input/output, D-sub connector, 25 pins, 8 inputs/outputs
EX600-DMNF		NPN input/output, Spring type terminal box, 32 pins, 8 inputs/outputs		
EX600-DMPF		PNP input/output, Spring type terminal box, 32 pins, 8 inputs/outputs		
Analog input unit	EX600-AXA	M12 connector, 5 pins (2 pcs.), 2-channel input		
Analog output unit	EX600-AYA	M12 connector, 5 pins (2 pcs.), 2-channel output		
Analog input/output unit	EX600-AMB	M12 connector, 5 pins (4 pcs.), 2-channel inputs/outputs		
IO-Link unit ^{Note 2)}	EX600-LAB1	Port class A, M12 connector, 5 pins (4 pcs.)		
	EX600-LBB1	Port class B, M12 connector, 5 pins (4 pcs.)		
④	End plate	EX600-ED2	M12 power supply connector, B-coded	
		EX600-ED2-2	M12 power supply connector, B-coded, with DIN rail mounting bracket	
		EX600-ED3	7/8 inch power supply connector	
		EX600-ED3-2	7/8 inch power supply connector, with DIN rail mounting bracket	
		EX600-ED4	M12 power supply connector IN/OUT, A-coded, Pin arrangement 1	
		EX600-ED4-2	M12 power supply connector IN/OUT, A-coded, Pin arrangement 1, with DIN rail mounting bracket	
		EX600-ED5	M12 power supply connector IN/OUT, A-coded, Pin arrangement 2	
		EX600-ED5-2	M12 power supply connector IN/OUT, A-coded, Pin arrangement 2, with DIN rail mounting bracket	
⑤	Valve plate	EX600-ZMV1	Enclosed parts: round head screws (M4 x 6) 2 pcs., round head screws (M3 x 8) 4 pcs.	

Note 1) The wireless system is suitable for use only in a country where it is in accordance with the Radio Act and regulations of that country.

Note 2) The compatible SI unit models are as shown below.

- PROFINET compatible: EX600-SPN3/EX600-SPN4/EX600-SPN31
- EtherNet/IP™ compatible: EX600-SEN7/EX600-SEN8
- EtherCAT compatible: EX600-SEC3/EX600-SEC4

VQC1000/2000 Series

Manifold Assembly Part No.

Housing Assembly and SI Unit/Input Block

No.	Description	Part no.	Note
⑥	SI unit	EX245-SPN1A	Communication connector: Push Pull connector (SCRJ); 2 pcs./Power supply connector: Push Pull connector (24 V); 2 pcs.
		EX245-SPN2A	Communication connector: Push Pull connector (RJ45); 2 pcs./Power supply connector: Push Pull connector (24 V); 2 pcs.
		EX245-SPN3A	Communication connector: M12 connector (4-pin, Socket, D-coded); 2 pcs./Power supply connector: 7/8 inch connector (5-pin, Plug); 1 pc. 7/8 inch connector (5-pin, Socket); 1 pc.
⑦	Digital input module	EX245-DX1	Digital input (16 inputs)
	Digital output module	EX245-DY1	Digital output (8 outputs)
	IO-Link module <small>Note 1)</small>	EX245-LA1	Port class A
EX245-LB1		Port class B	
⑧	End plate	EX245-EA2-5	
⑨	SI unit	EX250-SAS3	AS-Interface, 8 in/8 out, 2 power supply systems PNP (Negative common)
		EX250-SAS5	AS-Interface, 4 in/4 out, 2 power supply systems PNP (Negative common)
		EX250-SAS7	AS-Interface, 8 in/8 out, 1 power supply system PNP (Negative common)
		EX250-SAS9	AS-Interface, 4 in/4 out, 1 power supply system PNP (Negative common)
		EX250-SDN1	DeviceNet® PNP (Negative common)
		EX250-SEN1	EtherNet/IP™ PNP (Negative common)
⑩	Input block	EX250-IE1	M12, 2 inputs
		EX250-IE2	M12, 4 inputs
		EX250-IE3	M8, 4 inputs
⑪	End plate assembly	EX250-EA1	Standard
		EX250-EA2	For DIN rail mounting
⑫	SI unit	EX260-SDN1	DeviceNet®, M12 connector, 32 outputs PNP (Negative common)
		EX260-SDN2	DeviceNet®, M12 connector, 32 outputs NPN (Positive common)
		EX260-SDN3	DeviceNet®, M12 connector, 16 outputs PNP (Negative common)
		EX260-SDN4	DeviceNet®, M12 connector, 16 outputs NPN (Positive common)
		EX260-SPR1	PROFIBUS DP, M12 connector, 32 outputs PNP (Negative common)
		EX260-SPR2	PROFIBUS DP, M12 connector, 32 outputs NPN (Positive common)
		EX260-SPR3	PROFIBUS DP, M12 connector, 16 outputs PNP (Negative common)
		EX260-SPR4	PROFIBUS DP, M12 connector, 16 outputs NPN (Positive common)
		EX260-SPR5	PROFIBUS DP, D-sub connector, 32 outputs PNP (Negative common)
		EX260-SPR6	PROFIBUS DP, D-sub connector, 32 outputs NPN (Positive common)
		EX260-SPR7	PROFIBUS DP, D-sub connector, 16 outputs PNP (Negative common)
		EX260-SPR8	PROFIBUS DP, D-sub connector, 16 outputs NPN (Positive common)
		EX260-SMJ1	CC-Link, M12 connector, 32 outputs PNP (Negative common)
		EX260-SMJ2	CC-Link, M12 connector, 32 outputs NPN (Positive common)
		EX260-SMJ3	CC-Link, M12 connector, 16 outputs PNP (Negative common)
		EX260-SMJ4	CC-Link, M12 connector, 16 outputs NPN (Positive common)
		EX260-SEC1	EtherCAT, M12 connector, 32 outputs PNP (Negative common)
		EX260-SEC2	EtherCAT, M12 connector, 32 outputs NPN (Positive common)
		EX260-SEC3	EtherCAT, M12 connector, 16 outputs PNP (Negative common)
		EX260-SEC4	EtherCAT, M12 connector, 16 outputs NPN (Positive common)
		EX260-SPN1	PROFINET, M12 connector, 32 outputs PNP (Negative common)
		EX260-SPN2	PROFINET, M12 connector, 32 outputs NPN (Positive common)
		EX260-SPN3	PROFINET, M12 connector, 16 outputs PNP (Negative common)
		EX260-SPN4	PROFINET, M12 connector, 16 outputs NPN (Positive common)
		EX260-SEN1	EtherNet/IP™, M12 connector, 32 outputs PNP (Negative common)
		EX260-SEN2	EtherNet/IP™, M12 connector, 32 outputs NPN (Positive common)
		EX260-SEN3	EtherNet/IP™, M12 connector, 16 outputs PNP (Negative common)
		EX260-SEN4	EtherNet/IP™, M12 connector, 16 outputs NPN (Positive common)
		EX260-SPL1	Ethernet POWERLINK, M12 connector, 32 outputs PNP (Negative common)
		EX260-SPL3	Ethernet POWERLINK, M12 connector, 16 outputs PNP (Negative common)
EX260-SIL1	IO-Link M12 connector, 32 outputs PNP (Negative common)		
EX260-FPS1	PROFIsafe, M12 connector, 32 outputs PNP (Negative common)		
⑬	SI unit	EX126D-SMJ1	CC-Link NPN (Positive common)
⑭	Terminal block plate	VVQC1000-74A-2	For EX126 SI unit mounting
⑮	D-sub connector housing assembly	VVQC1000-F25-1	F kit, 25 pins
⑯	Flat ribbon cable housing assembly	VVQC1000-P26-1	P kit, 26 pins
		VVQC1000-P20-1	P kit, 20 pins
⑰	Terminal block box housing assembly	VVQC1000-T0-1	T kit
⑱	Lead wire housing assembly	VVQC1000-L25-0-1	L kit with 0.6 m lead wire
		VVQC1000-L25-1-1	L kit with 1.5 m lead wire
		VVQC1000-L25-2-1	L kit with 3.0 m lead wire
⑲	Circular connector housing assembly	VVQC1000-M26-1	M kit, 26 pins

Note 1) The only available SI unit part number is "EX245-SPN□A" (PROFINET compatible).

Manifold Assembly Part No.

<D-Side End Plate Assembly>

⑳ D-side end plate assembly part no.

VVQC 1 000-3A-1-□-□

Series

1	VQC1000
2	VQC2000

Port size

Symbol	VQC1000	VQC2000
C8	●	
C10		●
N9	●	
N11		●

Option

Nil	Common EXH
R	External pilot
S	Direct EXH outlet with built-in silencer

<U-Side End Plate Assembly>

㉓ U-side end plate assembly part no.

VVQC 1 000-2A-1-C8-□

Series

1	VQC1000
2	VQC2000

Supply/Exhaust port entry direction

1	Cylinder port side
2 ^{Note)}	Branch type

Note) VQC2000 only

Port size

Symbol	VQC1000	VQC2000
C8	●	
C10		●
C12		●
N9	●	
N11		●
N13		●

Option

Nil	Common EXH
R	External pilot
S	Direct EXH outlet with built-in silencer

<Manifold Block Assembly>

㉑ Manifold block assembly part no.

VVQC 1 000-1A-D-C6-□

Series

1	VQC1000
2	VQC2000

Note) Tie-rods (2 pcs.) for additional stations included.

Wiring specifications

D	Double wiring
S	Single wiring

Port size

Symbol	Port size	VQC1000	VQC2000
C3	For ø3.2 One-touch fitting	●	
C4	For ø4 One-touch fitting	●	●
C6	For ø6	●	●
C8	For ø8		●
N1	For ø1/8"	●	
N3	For ø5/32"	●	●
N7	For ø1/4"	●	●
N9	For ø5/16"		●
M5	For M5 thread	●	

Option

Nil	None
B	With back pressure check valve

* As the interface gasket is the same as that of the VQ series, refer to the **Web Catalog** for the part number.

<Replacement Parts>

Pilot valve assembly

V112 □ - 5 A

Coil voltage

5	24 VDC
6	12 VDC

Function

Nil	Standard (0.4 W)
B	High-speed response type (0.95 W)
K	High-pressure type (1.0 MPa, 0.95 W)

Note 1) Common to single solenoid and double solenoid

Note 2) The voltage (including light/surge voltage suppressor), positive common and negative common cannot be changed by changing the pilot valve assembly.

㉒ Tie-rod assembly part no. (2 pcs.)

VQC1000	VVQC1000-TR-□
VQC2000	VVQC2000-TR-□

Note 1) Please order when reducing the number of manifold stations. When increasing the number of stations, additional orders are not required since they are included in the manifold block assembly.

Note 2) □: Stations 02 to 24

VQC1000 Series

VQC1000: Manifold Optional Parts

Blanking plate assembly VVQ1000-10A-1

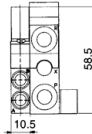
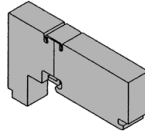

It is used by attaching on the manifold block for being prepared for removing a valve for maintenance reasons or planning to mount a spare valve, etc.

Individual SUP spacer VVQ1000-P-1-C6-N7

When the same manifold is to be used for different pressures, individual SUP spacers are used as SUP ports for different pressures. (One station space is occupied.) Block both sides of the station, for which the supply pressure from the individual SUP spacer is used, with SUP block plates. (Refer to the application example.)

* Specify the spacer mounting position and SUP block plate position by means of the manifold specification sheet.

The block plate is used in one or two places for one set. (Two SUP block plates for blocking SUP passage are attached to the individual SUP spacer.)

* As a standard, electric wiring is connected to the position of the manifold station where the individual SUP spacer is mounted.

* If wiring is not required for stations equipped with spacers, enter "X" in the special wiring specifications column in the manifold specification sheet.

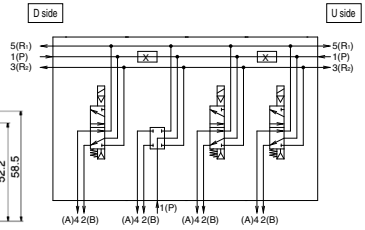
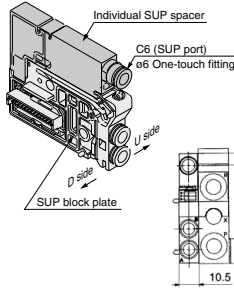

Individual EXH spacer VVQ1000-R-1-C6-N7

When valve exhaust affects other stations due to the circuit configuration, this spacer is used for individual valve exhaust. (One station space is occupied.) Block both sides of the individual valve EXH station. (Refer to the application example.)

* Specify the spacer mounting position, as well as the EXH passage blocking position by means of the manifold specification sheet. The block plate is used in one or two places for one set.

* An EXH block base assembly is used in the blocking position when ordering an EXH spacer incorporated with a manifold. However, do not order an EXH block base assembly because it is attached to the spacer.

When separately ordering an individual EXH spacer, separately order an EXH block base assembly because it is not attached to the spacer.

* As a standard, electric wiring is connected to the position of the manifold station where the individual EXH spacer is mounted.

* If wiring is not required for stations equipped with spacers, enter "X" in the special wiring specifications column in the manifold specification sheet.

* Do not install any back pressure check valve on the manifold station, on which the spacer is to be mounted. When installing the back pressure check valve on other manifold station, be sure to specify the manifold station position on the manifold specification sheet instead of ordering by specifying the manifold option symbol "B".

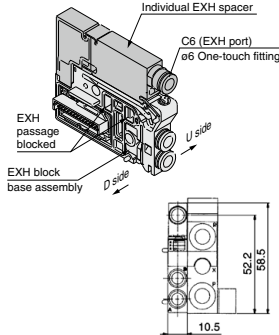

Description/Model		Stations						
		1	2	3	4	5	6	7
Valve	Single	●	●	●				
Option	Individual EXH spacer VVQ1000-R-1-C6	●						
	EXH blocking position: Specify 2 places.	●	●					

Individual EXH spacer + Valve + EXH block base assembly

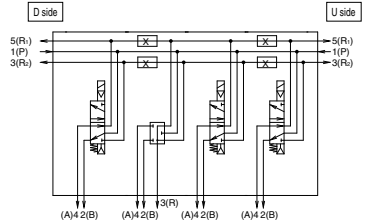

SUP block plate VVQ1000-16A

When different pressures are supplied to a manifold, a SUP block plate is used to block the stations under different pressures.

* Specify the mounting position by means of the manifold specification sheet.

<Block indication label>

Indication labels to confirm the blocking position are attached (Each for SUP passage and SUP/EXH passage blocking positions).

* When ordering a block plate incorporated with a manifold, a block indication label is attached to the manifold.

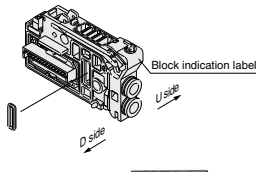

SUP passage blocked

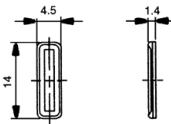

SUP/EXH passage blocked

Blanking plate with connector

VVQ1000-1C

Connector	Nil	300	20	2000
1 Without connector	6	600	25	2500
1 With connector/2-wire	10	1000	30	3000
2 With connector/4-wire	15	1500		

Connector lead wire length (mm)	Nil	300	20	2000
6	600	25	2500	
10	1000	30	3000	
15	1500			



Connector on the power supply side is not attached. Connector assembly

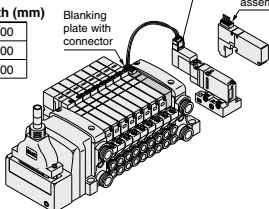

Connector assembly part no.

AXT661-43 A-6

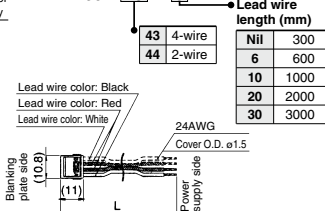

Blanking plate with a connector for individually outputting electricity to drive a single valve or equipment that are not on the manifold base.

* When "N" is suffixed to the end of the name plate, the plate will be different from a standard shape.

Note) Electric current should be 1A or less (including the mounted valves).

EXH block base assembly

VVQC1000-19A-(C3/C4/C6/M5/N1/N3/N7)

Wiring specifications

S	Single wiring
D	Double wiring

The manifold block assembly is used between stations for which exhaust is desired to be divided when valve exhaust affects other stations due to the circuit configuration. The EXH passage on the D-side is blocked in the EXH block base assembly. It is also used in combination with an individual EXH spacer for individual exhaust.

<Block indication labels>

Indication labels to confirm the blocking position are attached (Each for EXH passage and SUP/EXH passage blocking positions).

* When ordering this option incorporated with a manifold, a block indication label is attached to the manifold.

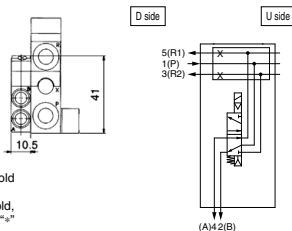
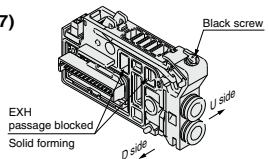

- * Specify the mounting position by means of the manifold specification sheet.
- * When ordering this option incorporated with a manifold, specify the EXH block base assembly part number with "-M" in front of it beneath the manifold part number.



EXH passage blocked



SUP/EXH passage blocked

Back pressure check valve assembly [-B]

VVQ1000-18A

It prevents cylinder from malfunctioning by other valve's exhaust entry. Insert it into R (EXH) port on the manifold side of a valve which is affected. It is effective when a single-acting cylinder is used or an exhaust center type solenoid valve is used.

* When ordering it being mounted on all manifold stations, suffix "-B" to the end of the manifold part number.

Note) When a back pressure check valve is desired, and is to be installed only in certain manifold stations, clearly indicate the part number and specify the mounting station by means of the manifold specification sheet.

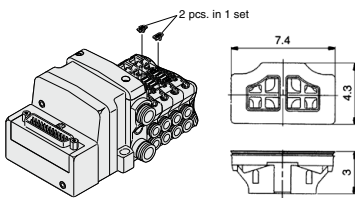

(Precautions)

- The manifold installed type back pressure check valve assembly is assembly parts with a check valve structure. However, since slight air leakage against the back pressure is allowed due to its structure, adverse effects of the back pressure due to increase in exhaust resistance cannot be prevented if the manifold exhaust port and other exhaust ports are put together for piping or if the piping diameter is narrowed. As a result, this may cause the actuator and air operated equipment to malfunction. So, be careful not to restrict the exhaust air.
- When a back pressure check valve is mounted, the effective area of the valve will decrease by about 20%.

Name plate [-N]

VVQ1000-NC -Station (1 to Max. stations) (-X4)

N: Standard
NC: For mounting blanking plate with connector

-X4: For mounting slide locking type manual valve

It is a transparent resin plate for placing a label that indicates solenoid valve function, etc. Insert it into the groove on the side of the end plate and bend it as shown in the figure.

* When the blanking plate with connector is mounted, it automatically will be "VVQ1000-NC-n"

* When the slide locking type manual valve is mounted, it automatically will be "VVQ1000-N-X4"

* When ordering this option incorporated with a manifold, suffix "-N" to the end of the manifold part number.

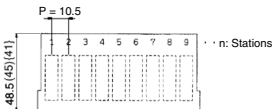
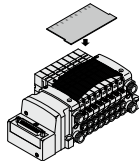

Note) { } : VVQ1000-NC-n
Note) [] : VVQ1000-N-X4

Blanking plug (For One-touch fittings)

KQ2P-□

It is inserted into an unused cylinder port and SUP/EXH ports. Purchasing order is available in units of 10 pieces.

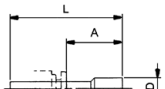

Dimensions

Applicable fitting size	Model	A	L	D	Applicable fitting size	Model	A	L	D
3.2	KQ2P-23	16	31.5	5	1/8"	KQ2P-01	16	31.5	5
4	KQ2P-04	16	32	6	5/32"	KQ2P-03	16	32	6
6	KQ2P-06	18	35	8	1/4"	KQ2P-07	18	35	8.5
8	KQ2P-08	20.5	39	10	5/16"	KQ2P-09	20.5	39	10

VQC1000 Series

VQC1000: Manifold Optional Parts

Port plug

VVQ0000-58A

The plug is used to block the cylinder port.

- * When ordering this option incorporated with a manifold, indicate "CM" for the port size of the manifold part number, as well as: the mounting position and number of stations and cylinder port mounting positions, 4(A) and 2(B) by means of the manifold specification sheet.
- * Gently screw an M3 screw in the port plug hole and pull it for removal.

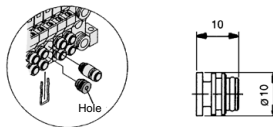

Elbow fitting assembly

VVQ1000-F-L(C3/C4/C6/M5/N1/N3/N7)

It is used for piping that extends upward or downward from the manifold.

- * When ordering this option incorporated with a manifold, indicate "L□" or "B□" for the manifold port size (when installed in all stations.)
- When installing it in part of the manifold stations, specify the elbow fitting assembly part number and the mounting position and number of stations by means of the manifold specification sheet.
- * When mounting elbow fitting assembly on the edge of manifold station and a silencer on EXH port, select a silencer, AN15-C08. A silencer (AN200-KM8) is interfered with fittings.

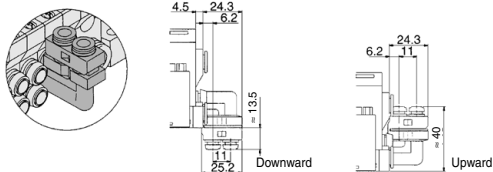

DIN rail mounting bracket [-D]

VVQ1000-57A

{For F/L/M/P/S (EX500) kit}

VVQC1000-57A-S

{For S (EX250) kit}

VVQC1000-57A-T (For T kit)

It is used for mounting a manifold on a DIN rail.

- * When ordering this option incorporated with a manifold, suffix "-D" to the end of the manifold part number.

1 set of DIN rail mounting bracket is used for 1 manifold (2 DIN rail mounting brackets).

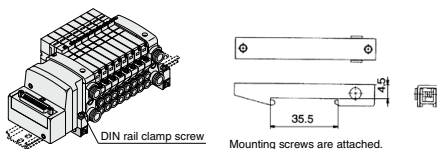

Direct EXH outlet with built-in silencer [-S]

This is a type with an exhaust outlet atop the manifold end plate. The built-in silencer exhibits an excellent noise suppression effect. (Noise reduction: 30 dB)

- * When ordering this option incorporated with a manifold, suffix "-S" to the end of the manifold part number.

Note) A large quantity of drainage generated in the air source results in exhaust of air together with drainage.

- Refer to page 1143 for maintenance.

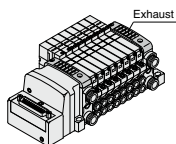

Dual flow fitting assembly

VVQ1000-52A-C₈N₃

This is a fitting to multiply the flow rate by combining the outputs of 2-valve stations. It is used for driving a large bore cylinder. This is a One-touch fitting for a port size of ø8 or ø5/16".

- * The port size of the manifold part number is "MM".
- Clearly indicate the dual flow fitting assembly part number and specify the mounting positions by means of the manifold specification sheet.
- * In dual flow fitting assembly, a special clip which is combined in one-piece of 2 stations is attached as a holding clip.

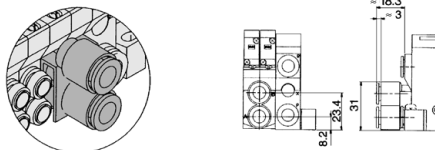

Silencer (For EXH port)

This silencer is to be inserted into the EXH port (One-touch fittings) of the common exhaust type.

- * When mounting elbow fitting assembly (VVQ1000-F-L□) on the edge of manifold station, select a silencer, AN15-C08. A silencer (AN200-KM8) is interfered with fittings.

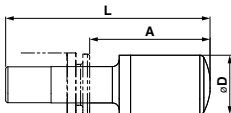

Dimensions

Series	Applicable fitting size øD	Model	A	L	D	Effective area (mm ²)	Noise reduction (dB)
VQC1000	8	AN15-C08	26.5	45	13	20	30

Double check block (Separated) for VQC1000
VQ1000-FPG-□□-□□

It is used on the outlet side piping to keep the cylinder in the intermediate position for long periods of time. Combining the double check block with a built-in pilot type double check valve and a 3-position exhaust center solenoid valve will enable the cylinder to stop in the middle or maintain its position for a long time. The combination with a 2-position single/double solenoid valve will permit this block to be used for preventing the dropping at the cylinder stroke end when the SUP residual pressure is released.

Specifications

Max. operating pressure	0.8 MPa
Min. operating pressure	0.15 MPa
Ambient and fluid temp.	-5 to 50°C
Flow rate characteristics: C	0.60 dm ³ /(s·bar)
Max. operating frequency	180 c.p.m

Note) Based on JIS B 8375-1981
 (Supply pressure: 0.5 MPa)

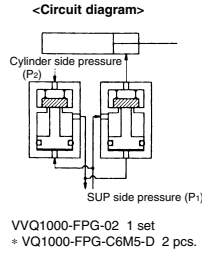
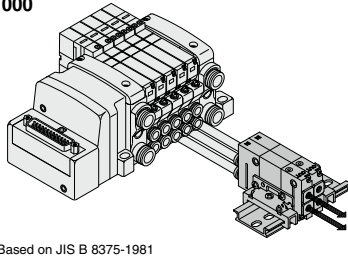

Dimensions

Single unit

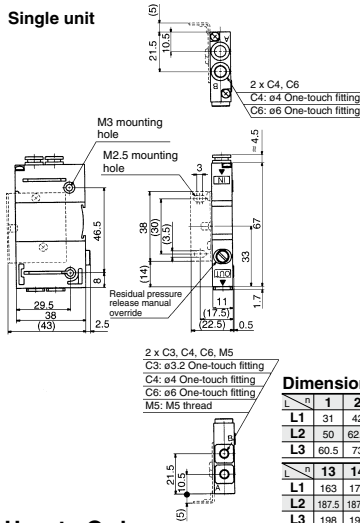

Manifold

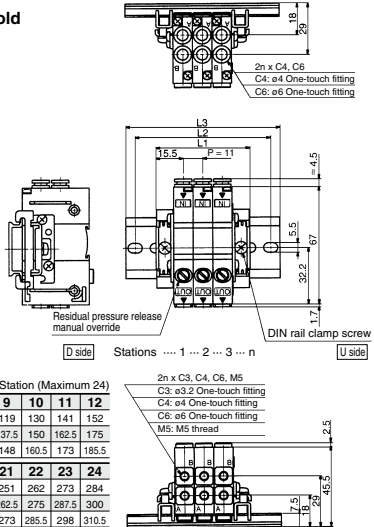

Dimensions

Formula L1 = 11n + 20 n: Station (Maximum 24)

	1	2	3	4	5	6	7	8	9	10	11	12
L1	31	42	53	64	75	86	97	108	119	130	141	152
L2	50	62.5	75	87.5	100	112.5	125	137.5	150	162.5	175	
L3	60.5	73	85.5	98	110.5	123	135.5	148	160.5	173	185.5	

	13	14	15	16	17	18	19	20	21	22	23	24
L1	163	174	185	196	207	218	229	240	251	262	273	284
L2	187.5	187.5	200	212.5	225	237.5	250	250	262.5	275	287.5	300
L3	198	198	210.5	223	235.5	248	260.5	260.5	273	285.5	298	310.5

How to Order

Double check block

VQ1000-FPG- **C4** **M5** - **F**

IN side port size

M5	M5 thread
C3	ø3.2 One-touch fitting
C4	ø4 One-touch fitting
C6	ø6 One-touch fitting
N3	ø5/32" One-touch fitting
N7	ø1/4" One-touch fitting

OUT side port size

M5	M5 thread
C3	ø3.2 One-touch fitting
C4	ø4 One-touch fitting
C6	ø6 One-touch fitting
N3	ø5/32" One-touch fitting
N7	ø1/4" One-touch fitting

Option

Nil	None
F	With bracket
D	DIN rail mounting (For manifold)
N	Name plate

Note) When two or more symbols are specified, indicate them alphabetically. Example) -DN

Caution

- Air leakage from the pipe between the valve and cylinder or from the fittings will prevent the cylinder from stopping for long periods of time. Check the leakage using neutral household detergent, such as dish washing soap. Also, check the cylinder's tube gasket, piston packing and rod packing for air leakage.
- Since One-touch fittings allow slight air leakage, screw piping (with M5 thread) is recommended when stopping the cylinder in the middle for long periods of time.
- Combining double check block with 3-position closed center or pressure center solenoid valve will not work.
- M5 fitting assembly is attached, not incorporated into the double check block. After screwing in the M5 fittings, mount the assembly on the double check block. (Tightening torque: 0.8 to 1.2 N·m)
- If the exhaust of the double check block is restricted too much, the cylinder may not operate properly and may not stop intermediately.
- Set the cylinder load so that the cylinder pressure will be within two times that of the supply pressure.

Manifold (DIN rail mounting)

VVQ1000-FPG- **06**

When ordering a double check block, order the DIN rail mounting [-D].

<Ordering example>

VVQ1000-FPG-06-6-station manifold
 *VQ1000-FPG-C4M5-D, 3 sets
 *VQ1000-FPG-C6M5-D, 3 sets

Stations

01	1 station
...	...
16	16 stations

Bracket Assembly

Part no.	Tightening torque
VQ1000-FPG-FB	0.22 to 0.25 N·m

Double check block

VQC2000 Series

VQC2000: Manifold Optional Parts

Blanking plate assembly VVQ2000-10A-1



It is used by attaching on the manifold block for being prepared for removing a valve for maintenance reasons or planning to mount a spare valve, etc.

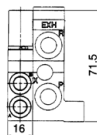
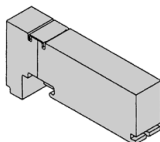

Individual SUP spacer VVQ2000-P-1- $\overline{C8}$

Individual SUP spacer

When the same manifold is to be used for different pressures, individual SUP spacers are used as SUP ports for different pressures. (One station space is occupied.)

Block both sides of the station, for which the supply pressure from the individual SUP spacer is used, with SUP block plates. (Refer to the application example.)

* Specify the spacer mounting position and SUP passage blocking position by means of the manifold specification sheet. The block plate is used in one or two places for one set. (Two SUP block plates for blocking SUP passage are attached to the individual SUP spacer.)

* As a standard, electric wiring is connected to the position of the manifold station where the individual SUP spacer is mounted.

* If wiring is not required for stations equipped with spacers, enter "X" in the special wiring specifications column in the manifold specification sheet.

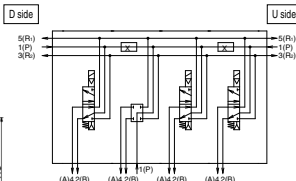
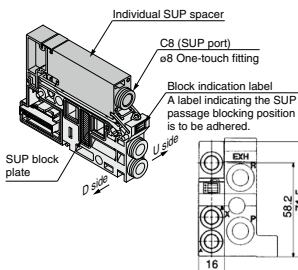

Individual EXH spacer VVQ2000-R-1- $\overline{C8}$

Individual EXH spacer

When valve exhaust affects other stations due to the circuit configuration, this spacer is used for individual valve exhaust. (One station space is occupied.)

Block both sides of the individual valve EXH station. (Refer to the application example.)

* Specify the spacer mounting position, as well as the EXH passage blocking position by means of the manifold specification sheet. The block plate is used in one or two places for one set. (Four EXH block plates (2 sets) for blocking EXH passage are attached to the individual EXH spacer.)

* As a standard, electric wiring is connected to the position of the manifold station where the individual EXH spacer is mounted.

* If wiring is not required for stations equipped with spacers, enter "X" in the special wiring specifications column in the manifold specification sheet.

* Do not install any back pressure check valve on other manifold station, on which the spacer is to be mounted. When installing the back pressure check valve on other manifold station, be sure to specify the manifold station position on the manifold specification sheet instead of ordering by specifying the manifold option symbol "B".

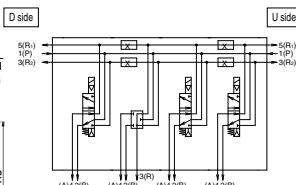
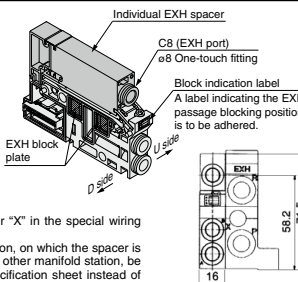

SUP block plate VVQ2000-16A

SUP block plate

When different pressures are supplied to a manifold, a SUP block plate is used to block the stations under different pressures.

* Specify the mounting position by means of the manifold specification sheet.

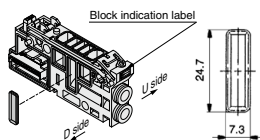

<Block indication label>

Indication labels to confirm the blocking position are attached. (Each for SUP passage and SUP/EXH passage blocking positions)



SUP passage blocked SUP/EXH passage blocked

* When ordering a block plate incorporated with a manifold, a block indication label is attached to the manifold.

EXH block plate VVQ2000-19A

EXH block plate

The EXH block plate is used between stations for which exhaust is desired to be divided when valve exhaust affects other stations configuration. It is also used in combination with an individual EXH spacer for individual exhaust.

* Specify the mounting position by means of the manifold specification sheet.

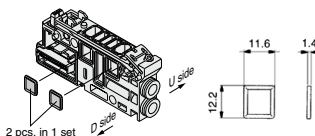

<Block indication label>

Indication labels to confirm the blocking position are attached. (Each for EXH passage and SUP/EXH passage blocking positions)



EXH passage blocked SUP/EXH passage blocked

* When ordering a block plate incorporated with a manifold, a block indication label is attached to the manifold.

Back pressure check valve assembly [-B] VVQ2000-18A

Back pressure check valve assembly [-B]

It prevents cylinder malfunction caused by other valve exhaust entry. Insert it into R (EXH) port on the manifold side of a valve which is actuated. It is effective when a single-acting cylinder is used or an exhaust center type solenoid valve is used.

* When ordering this option incorporated with a manifold, suffix "-B" to the end of the manifold part number.

Note) When a back pressure check valve is desired, and is to be installed only in certain manifold stations, clearly indicate the part number and specify the mounting position by means of the manifold specification sheet.

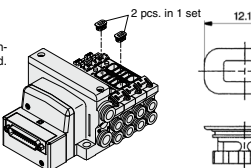

<Precautions>

- The manifold installed type back pressure check valve assembly is assembly parts with a check valve structure. However, since slight air leakage against the back pressure is allowed due to its structure, adverse effects of the back pressure due to increase in exhaust resistance cannot be prevented if the manifold exhaust port and other exhaust ports are put together for piping or if the piping diameter is narrowed. As a result, this may cause the actuator and air operated equipment to malfunction. So, be careful not to restrict the exhaust air.
- When a back pressure check valve is mounted, the effective area of the valve will decrease by about 20%.

Name plate [-N]

VVQ2000-N-Station (1 to Max. stations) (-X4)

-X4: For mounting slide locking type manual valve

It is a transparent resin plate for placing a label that indicates solenoid valve function, etc. Insert it into the groove on the side of the end plate and bend it as shown in the figure.
 * When the slide locking type manual valve is mounted, it automatically will be "VVQ2000-N-n-X4"
 * When ordering this option incorporated with a manifold, suffix "-N" to the end of the manifold part number.

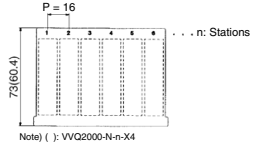
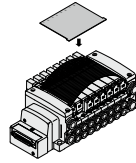

Blanking plug (For One-touch fittings)

KQ2P-□

It is inserted into an unused cylinder port and SUP/EXH ports.
 Purchasing order is available in units of 10 pieces.

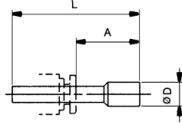
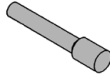

Dimensions

Applicable fitting size ϕd	Model	A	L	D
4	KQ2P-04	16	32	6
6	KQ2P-06	18	35	8
8	KQ2P-08	20.5	39	10
10	KQ2P-10	22	43	12
5/32"	KQ2P-03	16	32	6
1/4"	KQ2P-07	18	35	8.5
5/16"	KQ2P-09	20.5	39	10
3/8"	KQ2P-11	22	43	11.5

Port plug

VVQ1000-58A

The plug is used to block the cylinder port.
 * When ordering this option incorporated with a manifold, indicate "CM" for the port size of the manifold part number, as well as, the mounting station and cylinder port mounting positions, A and B, by means of the manifold specification sheet.

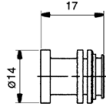
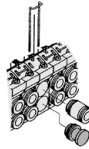

DIN rail mounting bracket [-D]

VVQC2000-57A

{For F/L/M/P/S (EX500) kit}

VVQC2000-57A-S

{For S (EX250) kit}

VVQC2000-57A-T (For T kit)

It is used for mounting a manifold on a DIN rail.
 * When ordering this option incorporated with a manifold, suffix "-D" to the end of the manifold part number.

1 set of DIN rail mounting bracket is used for 1 manifold (2 DIN rail mounting brackets).

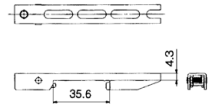
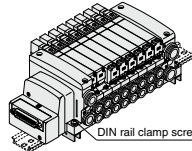

Direct EXH outlet with built-in silencer [-S]

This is a type with an exhaust outlet atop the manifold end plate. The built-in silencer exhibits an excellent noise suppression effect. (Noise reduction: 30 dB)
 * When ordering this option incorporated with a manifold, suffix "-S" to the end of the manifold part number.

Note) A large quantity of drainage generated in the air source results in exhaust of air together with drainage.

● Refer to page 1143 for maintenance.

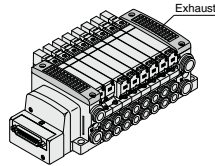

Silencer (For EXH port)

This silencer is to be inserted into the EXH port (One-touch fittings).

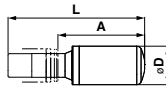

Dimensions

Series	Applicable fitting size ϕd	Model	A	L	D	Effective area (mm ²) (Cv factor)	Noise reduction (dB)
VQC2000	10	AN20-C10	36.5	57.5	16.5	30	30

Elbow fitting assembly

VVQ2000-F-L(C4/C6/C8/N3/N7/N9)

It is used for piping that extends upward or downward from the manifold.

When installing it only in some manifold stations, specify the elbow fitting assembly part number and the mounting position by means of the manifold specification sheet.

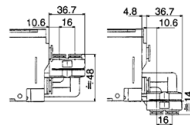

Dual flow fitting assembly

VVQ2000-52A-C10

This is a fitting to multiply the flow rate by combining the outputs of 2-valve stations. It is used for driving a large bore cylinder. This is a One-touch fitting for a port size of $\phi 10$ or $\phi 3/8"$.

* The port size of the manifold part number is "MM".
 Clearly indicate the dual flow fitting assembly part number and specify the mounting position by means of the manifold specifications.

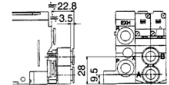

VQC2000 Series

VQC2000: Manifold Optional Parts

Double check block (Separated) for VQC2000

VQ2000-FPG-□□-□□

It is mounted on the outlet side piping to keep the cylinder in the intermediate position for long periods of time. Combining with a 3-position exhaust center solenoid valve will enable the cylinder to stop in the middle or maintain its position for a long time. Combining with a 2-position single/double solenoid valve will prevent a cylinder from dropping at the stroke end when the residual pressure of SUP is released.

Specifications

Max. operating pressure	0.8 MPa
Min. operating pressure	0.15 MPa
Ambient and fluid temp.	-5 to 50°C
Flow rate characteristics: C	3.0 dm ³ /(s·bar)
Max. operating frequency	180 c.p.m

(Note) Based on JIS B 8375-1981
(Supply pressure: 0.5 MPa)

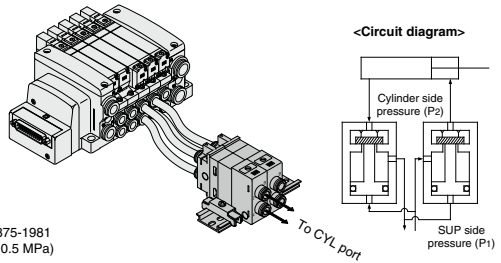

Dimensions

Single unit

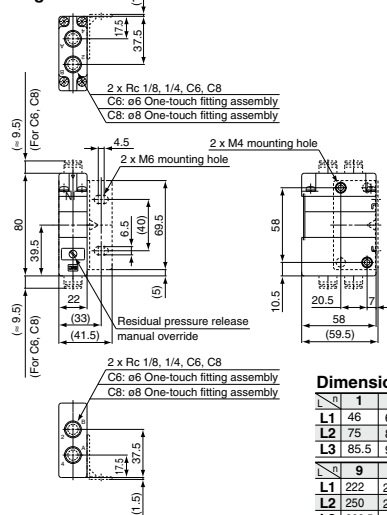

Manifold

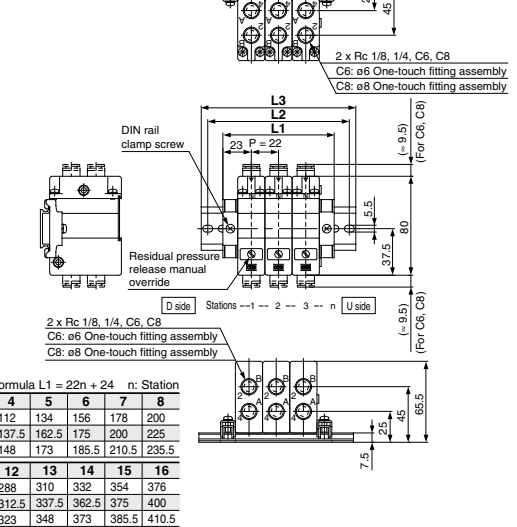

Dimensions

Formula L1 = 22n + 24 n: Station

	1	2	3	4	5	6	7	8
L1	46	68	90	112	134	156	178	200
L2	75	87.5	112.5	137.5	162.5	175	200	225
L3	85.5	98	123	148	173	185.5	210.5	235.5

	9	10	11	12	13	14	15	16
L1	222	244	266	288	310	332	354	376
L2	250	262.5	287.5	312.5	337.5	362.5	375	400
L3	260.5	273	298	323	348	373	385.5	410.5

How to Order

Double check block

VQ2000-FPG-01 01 - F

IN side port size

01	Rc 1/8
02	Rc 1/4
C6	ø6 One-touch fitting
C8	ø8 One-touch fitting
N7	ø1/4" One-touch fitting
N9	ø5/16" One-touch fitting

OUT side port size

01	Rc 1/8
02	Rc 1/4
C6	ø6 One-touch fitting
C8	ø8 One-touch fitting
N7	ø1/4" One-touch fitting
N9	ø5/16" One-touch fitting

Option

Nil	None
D	DIN rail mounting (For manifold)
F	With bracket
N	Name plate

(Note) When two or more symbols are specified, indicate them alphabetically.
Example) -DN

<Example>

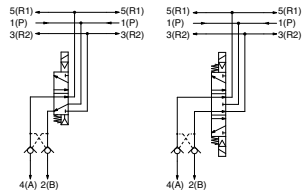

Manifold (DIN rail mounting)

VVQ2000-FPG-06

When ordering a double check block, order the DIN rail mounting [-D].

Stations	
01	1 station
⋮	⋮
16	16 stations

<Ordering example>

VVQ2000-FPG-06-6-station manifold

*VQ2000-FPG-C6C6-D, 3set
*VQ2000-FPG-C8C8-D, 3set

Bracket Assembly

Part no.	Tightening torque
VQ2000-FPG-FB	0.8 to 1.0 N·m

⚠ Caution

- Air leakage from the pipe between the valve and cylinder or from the fittings will prevent the cylinder from stopping for long periods of time. Check the leakage using neutral household detergent, such as dish washing soap. Also, check the cylinder's tube gasket, piston packing and rod packing for air leakage.
- Since One-touch fittings allow slight air leakage, screw piping is recommended when stopping the cylinder in the middle for long periods of time.
- Combining double check block with 3-position closed center or pressure center solenoid valve will not work.
- When fittings, etc. are being screwed to the double check block, tighten them with the torque below.

Connection thread	Proper tightening torque (N·m)
Rc 1/8	7 to 9
Rc 1/4	12 to 14

- If the exhaust of the double check block is restricted too much, the cylinder may not operate properly and may not stop intermediately.
- Set the cylinder load so that the cylinder pressure will be within two times that of the supply pressure.



VQC1000/2000 Series Specific Product Precautions 1

Be sure to read this before handling the products. For safety instructions and 3/4/5-port solenoid valve precautions, refer to the "Handling Precautions for SMC Products" and the "Operation Manual" on the SMC website: <https://www.smcworld.com>

Manual Override

Warning

Connected actuator is started by manual operation. Use the manual override after confirming that there is no danger. Push type is standard. (Tool required) Locking type is semi-standard. (Tool required)

Non-locking push type (Tool required)

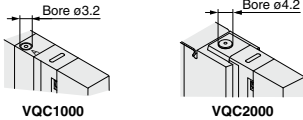

Push down on the manual override with a small screwdriver until it stops. Release the screwdriver and the manual override will return.

Locking type (Tool required) <Semi-standard>

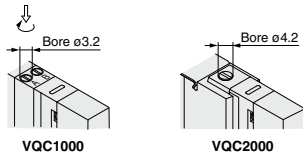

Push down on the manual override with a small flat head screwdriver until it stops. Turn it clockwise by 90° to lock it. Turn it counterclockwise to release it.

Locking type (Manual) <Semi-standard>

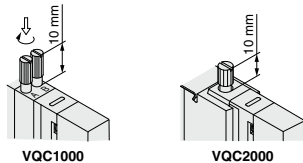

Push down on the manual override with a small screwdriver or with your fingers until it stops. Turn it clockwise by 90° to lock it. Turn it counterclockwise to release it.

Caution

Do not apply excessive torque when turning the locking type manual override. (0.1 N·m or less)

Warning

Slide locking type (Manual) <Semi-standard>

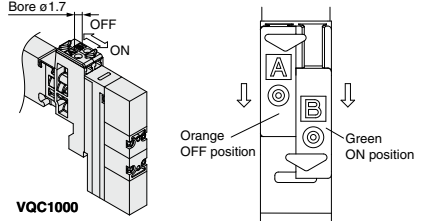

VQC1000

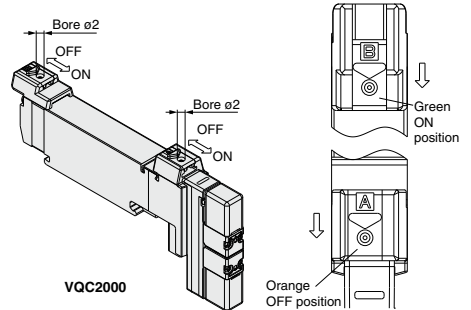

VQC2000

The manual override is locked by sliding it all the way to the pilot valve side (ON side) with a small flat head screwdriver or with your fingers. Slide it to the fitting side (OFF side) to release it. In addition, it can also be used as a push type by using a screwdriver, etc., of ø1.7 or less. (ø2 or less for VQC2000)

How to Mount/Remove Solenoid Valves

Caution

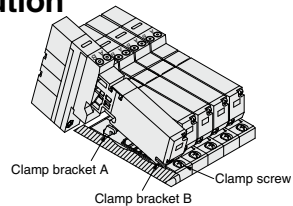

Removing

1. Loosen the clamp screw until it turns freely. (The screw is captive.)
2. Lift the coil side of the valve body while pressing down slightly on the screw head and remove it from the clamp bracket B. When the screw head cannot be pressed easily, gently press the area near the manual override of the valve.

Mounting

1. Press down on the clamp screw. Clamp bracket A opens. Diagonally insert the hook on the valve end plate side into clamp B.
2. Press the valve body downward. (When the screw is released, it will be locked by clamp bracket A.)
3. Tighten the clamp screw. (Proper tightening torque: VQC1000, 0.25 to 0.35 N·m; VQC2000, 0.5 to 0.7 N·m)

Caution

Dust on the sealing surface of the gasket or solenoid valve can cause air leakage.



VQC1000/2000 Series Specific Product Precautions 2

Be sure to read this before handling the products. For safety instructions and 3/4/5-port solenoid valve precautions, refer to the "Handling Precautions for SMC Products" and the "Operation Manual" on the SMC website: <https://www.smcworld.com>

Cylinder Port Fittings Replacement

⚠ Caution

One-touch fittings on the cylinder port are a cassette for easy replacement. The fittings are blocked by a clip. After removing the corresponding valve and take out the clip with a flat head screwdriver, etc., then replace the fittings.

For mounting, insert the fitting until it strikes against the inside wall and then insert the clip to the specified position.

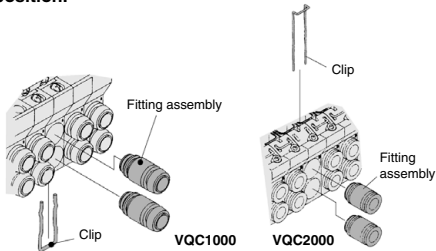

Applicable tubing O.D.	Fitting assembly part no.	
	VQC1000	VQC2000
Applicable tubing ø3.2	VVQ1000-50A-C3	—
Applicable tubing ø4	VVQ1000-50A-C4	VVQ1000-51A-C4
Applicable tubing ø6	VVQ1000-50A-C6	VVQ1000-51A-C6
Applicable tubing ø8	—	VVQ1000-51A-C8
M5	VVQ1000-50A-M5	—
Applicable tubing ø1/8"	VVQ1000-50A-N1	—
Applicable tubing ø5/32"	VVQ1000-50A-N3	VVQ1000-51A-N3
Applicable tubing ø1/4"	VVQ1000-50A-N7	VVQ1000-51A-N7
Applicable tubing ø5/16"	—	VVQ1000-51A-N9

* Refer to "Manifold Optional Parts" on pages 1136 and 1139 for other types of fittings.

⚠ Caution

- 1) Use caution that O-rings must be free from scratches and dust. Otherwise, air leakage may result.
- 2) After screwing in the fittings, mount the M5 fitting assembly on the manifold base. (Tightening torque: 0.8 to 1.2 N·m)
- 3) Purchasing order is available in units of 10 pieces.

Light/Surge Voltage Suppressor

⚠ Caution

The lighting positions are concentrated on one side for both single solenoid type and double solenoid type. In the double solenoid type, A side and B side energization are indicated by two colors which match the colors of the manual overrides.

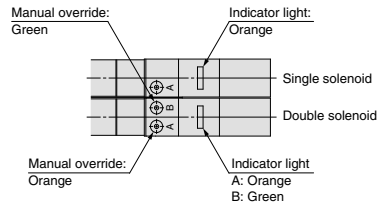

(Drawing shows a VQC1000 case.)

DC circuit diagram

Single solenoid

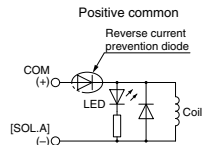

Double solenoid

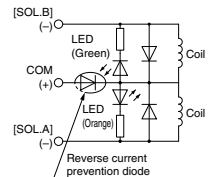

Note) A-side energization:

A light (Orange) illuminates.

B-side energization:

B light (Green) illuminates.

With wrong wiring prevention (stop diode) mechanism

With a surge absorption (surge absorption diode) mechanism

Continuous Duty

⚠ Caution

If a valve is energized continuously for long periods of time, the rise in temperature due to heat-up of the coil assembly may cause a decline in solenoid valve performance, reduce service life, or have adverse effects on peripheral equipment. In particular, if three or more adjacent stations on the manifold are energized simultaneously for extended periods of time or if the valves on A side and B side are energized simultaneously for long periods of time, take special care as the temperature rise will be greater. In such cases, if it is possible to select a valve with a power-saving circuit, be sure to do so.

UL Approved Product

⚠ Caution

When conformity to UL is required, the product should be used with a UL1310 Class 2 power supply.

The product is a UL approved product only if it has a  mark on the body.



VQC1000/2000 Series

Specific Product Precautions 3

Be sure to read this before handling the products. For safety instructions and 3/4/5-port solenoid valve precautions, refer to the "Handling Precautions for SMC Products" and the "Operation Manual" on the SMC website: <https://www.smcworld.com>

How to Mount/Remove DIN Rail

⚠ Caution

Removing

- Loosen the clamp screw on side (a) of the end plate on both sides.
- Lift side (a) of the manifold base and slide the end plate in the direction of (2) shown in the figure to remove.

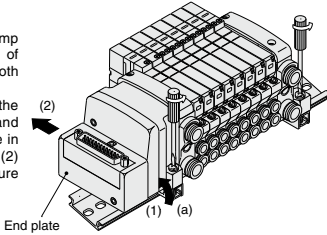

Mounting

- Hook side (b) of the manifold base on the DIN rail.
- Press down side (a) and mount the end plate on the DIN rail. Tighten the clamp screw on side (a) of the end plate. (Proper tightening torque: VQC1000, 1.1 to 1.3 N·m; VQC2000, 1.4 to 1.6 N·m.)

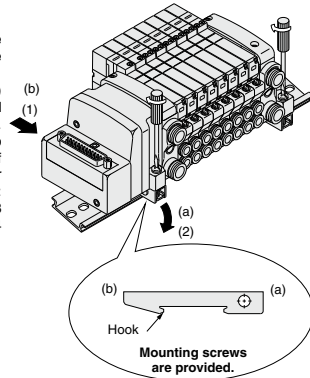

IP67 Enclosure

⚠ Caution

Wiring connection for models conforming to IP67 should also have enclosures equivalent to or of stricter than IP67.

Built-in Silencer Element

⚠ Caution

A filter element is incorporated in the end plate on both sides of the manifold base. A dirty and choked element may reduce cylinder speed or cause malfunction. Clean or replace the dirty element.

Element Part No.

Type	Element part no.	
	VQC1000	VQC2000
Direct EXH outlet with built-in silencer	VVQ1000-82A-1	VVQ2000-82A-1 (D-side end plate) VVQC2000-82A-1 (U-side end plate)

The minimum order quantity is 10 pcs.

Remove the cover from the top of the end plate and remove the old element with a flat head screwdriver, etc.

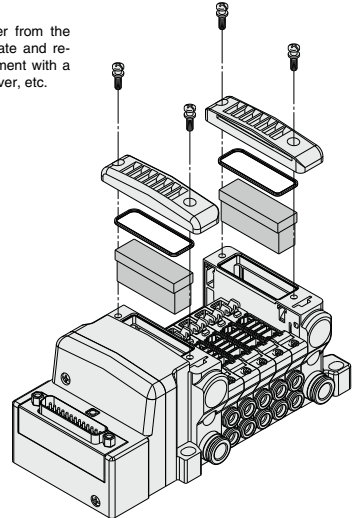

How to Calculate Flow Rate

Refer to the **Web Catalog** for obtaining the flow rate.



VQC1000/2000 Series

Specific Product Precautions 4

Be sure to read this before handling the products. For safety instructions and 3/4/5-port solenoid valve precautions, refer to the “Handling Precautions for SMC Products” and the “Operation Manual” on the SMC website: <https://www.smcworld.com>

EX500/EX260/EX250/EX126 Precautions

Warning

1. These products are intended for use in general factory automation equipment.
Avoid using these products in machinery/equipment which affects human safety, and in cases where malfunction or failure can result in extensive damage.
2. Do not use in explosive environments, in the presence of inflammable gases, or in corrosive environments. This can cause injury or fire.
3. Work such as transporting, installing, piping, wiring, operation, control and maintenance should be performed by knowledgeable and qualified personnel only. As handling involves the risk of a danger of electrocution, injury or fire.
4. Install an external emergency stop circuit that can promptly stop operation and shut off the power supply.
5. Do not modify these products. Modifications done to these products carry the risk of injury and damage.

Caution

1. Read the Operation Manual carefully, strictly observe the precautions and operate within the range of the specifications.
2. Do not drop these products or submit them to strong impacts. This can cause damage, failure or malfunction.
3. In locations with poor electrical conditions, take steps to ensure a steady flow of the rated power supply. Use of a voltage outside of the specifications can cause malfunction, damage to the unit, electrocution or fire.
4. Do not touch connector terminals or internal circuit elements when current is being supplied. There is a danger of malfunction, damage to the unit or electrocution if connector terminals or internal circuit elements are touched when current is being supplied.

Be sure that the power supply is OFF when adding or removing manifold valves or input blocks or when connecting or disconnecting connectors.

5. Operate at an ambient temperature that is within the specifications. Even when the ambient temperature range is within the specifications, do not use in locations where there are rapid temperature changes.
6. Keep wire scraps and other extraneous materials from getting inside these products. This can cause fire, failure or malfunction.
7. Give consideration to the operating environment depending on the type of enclosure being used.

To achieve IP65 and IP67 protection class, provide appropriate wiring between all units using electrical wiring cables, communication connectors and cables with M12 connectors. Also, provide waterproof caps when there are unused ports, and perform proper mounting of input units, input blocks, SI units and manifold valves. Provide a cover or other protection for applications in which there is constant exposure to water.

8. Use the proper tightening torques.
There is a possibility of damaging threads if tightening exceeds the tightening torque range.
9. Provide adequate protection when operating in locations such as follows:
 - Where noise is generated by static electricity
 - Where there is a strong electric field
 - Where there is a danger of exposure to radiation
 - When in close proximity to power supply lines

Caution

10. When these products are installed in equipment, provide adequate protection against noise by using noise filters.
11. Since these products are components whose end usage is obtained after installation in other equipment, the customer should confirm conformity to EMC directives for the finished product.
12. Do not remove the name plate.
13. Perform periodic inspections and confirm normal operation, otherwise it may be impossible to guarantee safety due to unexpected malfunction or erroneous operation.
14. Do not use in places where there are cyclic temperature changes.
In case that the cyclic temperature is beyond normal temperature changes, the inside product is likely to be adversely affected.
15. Do not use in direct sunlight.
Do not use in direct sunlight. It may cause malfunction or damage.
16. Do not use in places where there is radiated heat around it.
Such a place is likely to cause malfunction.

Safety Instructions on Power Supply

Caution

1. Operation is possible with a single power supply or a separate power supply. However, be sure to provide two wiring systems (one for solenoid valves, and one for input and control units).
2. When it is UL compliant, use a class 2 power supply unit in accordance with UL1310 for a combined direct current power supply.

Safety Instructions on Cable

Caution

1. Avoid miswiring, as this can cause malfunction, damage and fire in the unit.
2. To prevent noise and surge in signal lines, keep all wiring separate from power lines and high-voltage lines. Otherwise, this can cause malfunction.
3. Check wiring insulation, as defective insulation can cause damage to the unit when excessive voltage or current is applied.
4. Do not bend or pull cables repeatedly, and do not place heavy objects on them or allow them to be pinched. This can cause broken lines.



VQC1000/2000 Series

Specific Product Precautions 5

Be sure to read this before handling the products. For safety instructions and 3/4/5-port solenoid valve precautions, refer to the "Handling Precautions for SMC Products" and the "Operation Manual" on the SMC website: <https://www.smcworld.com>

EX600 Precautions

Design/Selection

Warning

- 1. Use this product within the specification range.**
Using beyond the specified specifications range can cause fire, malfunction, or damage to the system.
Confirm the specifications when operating.
- 2. When using for an interlock circuit:**
 - Provide a multiple interlock system which is operated by another system (such as mechanical protection function).
 - Perform an inspection to check that it is working properly.

This may cause possible injury due to malfunction.

Caution

- 1. When it is UL compliant, use a class 2 power supply unit in accordance with UL1310 for a combined direct current power supply.**
- 2. Use this product within the specified voltage range.**
Using beyond the specified voltage range is likely to cause the units and connecting devices to be damaged or to malfunction.
- 3. The power supply for the unit should be 0 V as the standard for both power supply for output as well as power supply for control/input.**

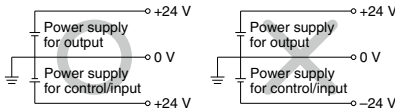

- 4. Do not install a unit in a place where it can be used as a foothold.**
Applying any excessive load such as stepping on the unit by mistake or placing a foot on it, will cause it to break.
- 5. Keep the surrounding space free for maintenance.**
When designing a system, take into consideration the amount of free space needed for performing maintenance.
- 6. Do not remove the name plate.**
Improper maintenance or incorrect use of the Operation Manual can cause failure and malfunction. Also, there is a risk of losing conformity with safety standards.
- 7. Beware of inrush current when the power supply is turned on.**
Some connected loads can apply an initial charge current which will trigger the over current protection function, causing the unit to malfunction.

Mounting

Caution

- 1. When handling and assembling units:**
 - Do not touch the sharp metal parts of the connector or plug.
 - Do not apply excessive force to the unit.
The connecting portions of the unit are firmly joined with seals.
 - When joining units, take care not to get fingers caught between units.
Injury can result.
- 2. Do not drop, bump, or apply excessive impact.**
Otherwise, the unit can become damaged, malfunction, or fail to function.
- 3. Observe the tightening torque range.**
Tightening outside of the allowable torque range will likely damage the product.
IP67 protection class cannot be guaranteed if the screws are not tightened to the specified torque.
- 4. When lifting a large size manifold solenoid valve unit, take care to avoid causing stress to the valve connection joint.**
The connection parts of the unit may be damaged.
Because the unit may be heavy, carrying and installation should be performed by more than one operator to avoid strain or injury.
- 5. When placing a manifold, mount it on a flat surface.**
Torsion in the whole manifold can lead to trouble such as air leakage or defective insulation.

Wiring

Caution

- 1. Confirm grounding to maintain the safety of the reduced wiring system and for anti-noise performance.**
Provide a specific grounding as close to the unit as possible to minimize the distance to grounding.
- 2. Avoid repeatedly bending or stretching the cable and applying a heavy object or force to it.**
Wiring applying repeated bending and tensile stress to the cable can break the circuit.
- 3. Avoid miswiring.**
If miswired, there is a danger of malfunction or damage to the reduced wiring system.
- 4. Do not wire while energizing the product.**
There is a danger of malfunction or damage to the reduced wiring system or input/output equipment.

■ Trademark

DeviceNet® is a registered trademark of ODVA, Inc.
EtherNet/IP® is a registered trademark of ODVA, Inc.
EtherCAT® is registered trademark and patented technology, licensed by Beckhoff Automation GmbH, Germany.



VQC1000/2000 Series

Specific Product Precautions 6

Be sure to read this before handling the products. For safety instructions and 3/4/5-port solenoid valve precautions, refer to the "Handling Precautions for SMC Products" and the "Operation Manual" on the SMC website: <https://www.smcworld.com>

EX600 Precautions

Wiring

Caution

5. Avoid wiring the power line and high-pressure line in parallel.

Noise or surge produced by signal line resulting from the power line or high pressure line could cause malfunction.

Wiring of the reduced wiring system or input/output device and the power line or high-pressure line should be separated from each other.

6. Confirm the wiring insulation.

Defective insulation (contact with other circuits, improper insulation between terminals, etc.) may cause damage to the reduced wiring system or input/output device due to excessive voltage or current.

7. When a reduced wiring system is installed in machinery/equipment, provide adequate protection against noise by using noise filters, etc.

Noise in signal lines may cause malfunction.

8. When connecting wires of input/output device or handheld terminal, prevent water, solvent or oil from entering inside from the connector section.

This can cause damage, equipment failure, or malfunction.

9. Avoid wiring patterns in which excessive stress is applied to the connector.

This may cause malfunction or damage to the unit due to contact failure.

Operating Environment

Warning

1. Do not use in an atmosphere containing an inflammable gas or explosive gas.

Use in such an atmosphere is likely to cause a fire or explosion. This system is not explosion-proof.

Caution

1. Select the proper type of enclosure according to the environment of operation.

IP65/67 protection class is achieved when the following conditions are met.

1) The units are connected properly with wiring cable for power supply, communication connector, and cable with M12 connector.

2) Suitable mounting of each unit and manifold valve.

3) Be sure to mount a seal cap on any unused connectors.

If using in an environment that is exposed to water splashes, please take measures such as using a cover.

For IP40 protection class, do not use in atmospheres with corrosive gas, chemicals, sea water, water, steam, or where there is direct contact with any of these.

When EX600-D□□E or EX600-D□□F are connected, the enclosure of the manifold should be IP40.

Also, the Handheld Terminal confirms to IP20, so prevent foreign matter from entering inside, and water, solvent or oil from coming in direct contact with it.

Operating Environment

Caution

2. Provide adequate protection when operating in locations such as the following.

Failure to do so may cause damage or malfunction.

The effect of countermeasures should be checked in individual equipment and machine.

1) Where noise is generated by static electricity, etc.

2) Where there is a strong electric field

3) Where there is a danger of exposure to radiation

4) When in close proximity to power supply lines

3. Do not use in an environment where oil and chemicals are used.

Operating in environments with coolants, cleaning solvents, various oils or chemicals may cause adverse effects (damage, malfunction) to the unit even in a short period of time.

4. Do not use in an environment where the product could be exposed to corrosive gas or liquid.

This may damage the unit and cause it to malfunction.

5. Do not use in locations with sources of surge generation.

Installation of the unit in an area around the equipment (electromagnetic lifters, high frequency induction furnaces, welding machine, motors etc.), which generates the large surge voltage could cause to deteriorate an internal circuitry element of the unit or result in damage. Implement countermeasures against the surge from the generating source, and avoid touching the lines with each other.

6. Use the product type that has an integrated surge absorption element when directly driving a load which generates surge voltage by relay, solenoid valves or lamp.

When a surge generating load is directly driven, the unit may be damaged.

7. The product is CE/UKCA marked, but not immune to lightning strikes. Take measures against lightning strikes in your system.

8. Keep dust, wire scraps and other extraneous material from getting inside the product.

This may cause malfunction or damage.

9. Mount the unit in such locations, where no vibration or shock is affected.

This may cause malfunction or damage.

10. Do not use in places where there are cyclic temperature changes.

In case that the cyclic temperature is beyond normal temperature changes, the internal unit is likely to be adversely effected.

11. Do not use in direct sunlight.

Do not use in direct sunlight. It may cause malfunction or damage.

12. Use this product within the specified ambient temperature range.

This may cause malfunction.

13. Do not use in places where there is radiated heat around it.

Such a place is likely to cause malfunction.



VQC1000/2000 Series

Specific Product Precautions 7

Be sure to read this before handling the products. For safety instructions and 3/4/5-port solenoid valve precautions, refer to the "Handling Precautions for SMC Products" and the "Operation Manual" on the SMC website: <https://www.smcworld.com>

EX600 Precautions

Adjustment/Operation

Warning

1. Do not perform operation or setting with wet hands.

There is a risk of electrical shock.

<Handheld Terminal>

2. Do not apply pressure to the LCD display.

There is a possibility of the crack of LCD display and injuring.

3. The forced input/output function is used to change the signal status forcibly. When operating this function, be sure to check the safety of the surroundings and installation.

Otherwise, injury or equipment damage could result.

4. Incorrect setting of parameters can cause malfunction. Be sure to check the settings before use.

This may cause injury or equipment damage.

Caution

1. Use a watchmaker's screwdriver with thin blade for the setting of each switch of the SI unit.

When setting the switch, do not touch other unrelated parts.

This may cause parts damage or malfunction due to a short circuit.

2. Provide adequate setting for the operating conditions.

Failure to do so could result in malfunction.

Refer to the Operation Manual for setting of the switches.

3. For the details of programming and address setting, refer to the manual from the PLC manufacturer.

The content of programming related to protocol is designed by the manufacturer of the PLC used.

<Handheld Terminal>

4. Do not press the setting buttons with a sharp pointed object.

This may cause damage or malfunction.

5. Do not apply excessive load and impact to the setting buttons.

This may cause damage, equipment failure or malfunction.

When the order does not include the SI unit, the valve plate to connect the manifold and SI unit is not mounted. Use attached valve fixing screws and mount the valve plate.
(Tightening torque: 0.6 to 0.7 N·m)

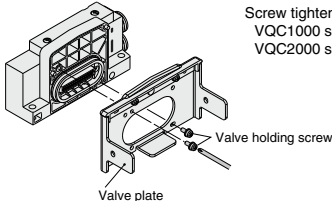

Screw tightened parts
VQC1000 series: 2 places
VQC2000 series: 3 places

Maintenance

Warning

1. Do not disassemble, modify (including circuit board replacement) or repair this product.

Such actions are likely to cause injuries or breakage.

2. When an inspection is performed,

- Turn off the power supply.
- Stop the air supply, exhaust the residual pressure in piping and verify that the air is released before performing maintenance work.

Unexpected malfunction of system components and injury can result.

Caution

1. When handling and replacing the unit:

- Do not touch the sharp metal parts of the connector or plug.

- Do not apply excessive force to the unit.

The connecting portions of the unit are firmly joined with seals.

- When joining units, take care not to get fingers caught between units.

Injury can result.

2. Perform periodic inspection.

Unexpected malfunction in the system composition devices is likely to occur due to malfunction of machinery or equipment.

3. After maintenance, make sure to perform an appropriate functionality inspection.

In cases of abnormality such as faulty operation, stop operation. Unexpected malfunction in the system composition devices is likely to occur.

4. Do not use benzene and thinner for cleaning units.

Damage to the surface or erasure of the display can result. Wipe off any stains with a soft cloth.

If the stain is persistent, wipe off with a cloth soaked in a dilute solution of neutral detergent and wrung out tightly, and then finish with a dry cloth.

■ Trademark

DeviceNet® is a registered trademark of ODVA, Inc.

EtherNet/IP® is a registered trademark of ODVA, Inc.

EtherCAT® is registered trademark and patented technology, licensed by Beckhoff Automation GmbH, Germany.

