

Blow Gun

VMG Series

RoHS

20% reduction in power consumption

with the SMC "Blow gun" + "S coupler" + "Coil tube"

*10% reduction with the "Blow gun (VMG)" only

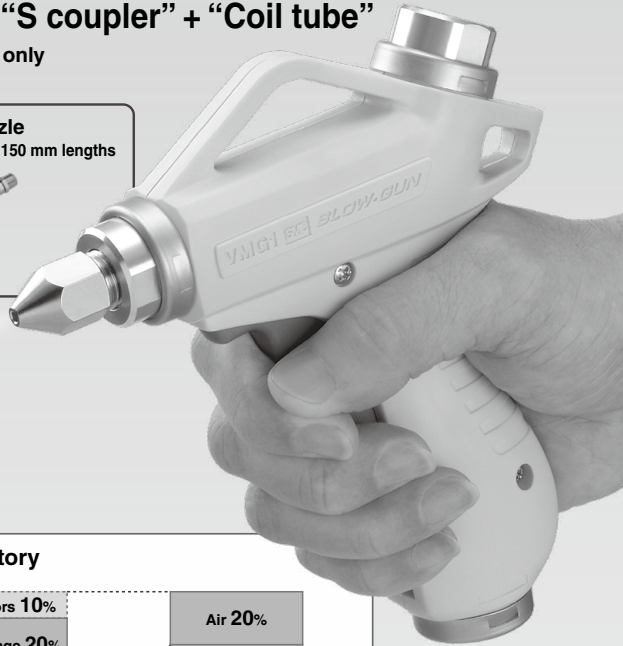
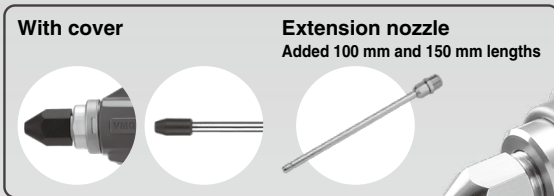

Pressure loss 1% or less

■ Amount of electricity used in a factory

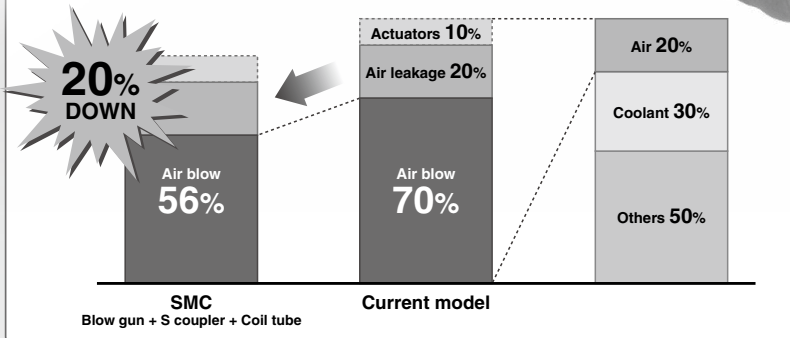

The electricity used by compressors for air accounts for **approximately 20%** of that consumed by the entire factory. Also, **70%** of the air consumed in the process is used for air blowing. SMC blow guns have minimal pressure loss compared with current models, so they can achieve equivalent performance at lower pressures and with less volume of air consumption. As a result, it is possible to achieve a **20% reduction** in power consumption.

Energy Saving Pneumatic System Proposal

Energy Saving Effects

When the yearly total working hours spent on air blowing amounts to 8,300 hours, use of current models results in power consumption costs totaling 194,220 yen. When using the SMC system (Blow gun + S coupler + Coil tube), however, the yearly cost is reduced to 155,625 yen, for a total yearly saving of **38,595 yen**, or **20%** of the total.

Energy saving effects with **Blow gun (VMG) + S coupler + Coil tube**

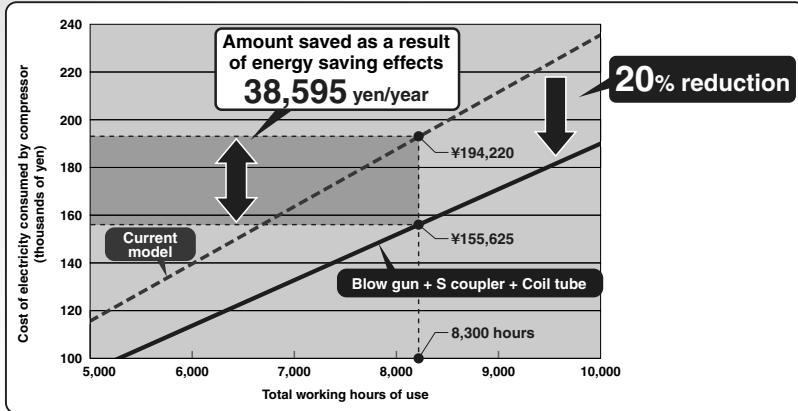

Energy saving effects with **Blow gun (VMG) only**

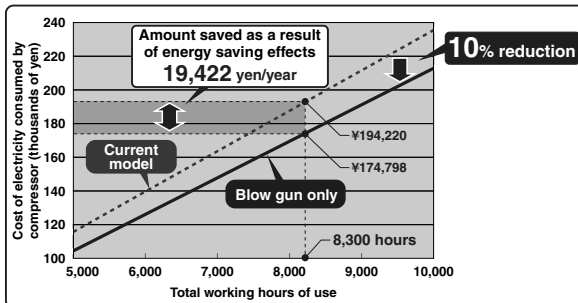

Calculation conditions

- Blowing distance: 100 mm
- Impact pressure: 0.011 MPa
- Cost of electricity: 15 yen/kWh

Work model

- Blow time: 10 seconds
- Frequency: 12 times/hour
- Working hours: 10 hours/day
- Working days: 250 days/year
- Units used: 100
- Resulting total working hours: 8,300 hours

Valve Construction and Pressure Loss

Straighter flowing fluid
"improves pressure loss!"

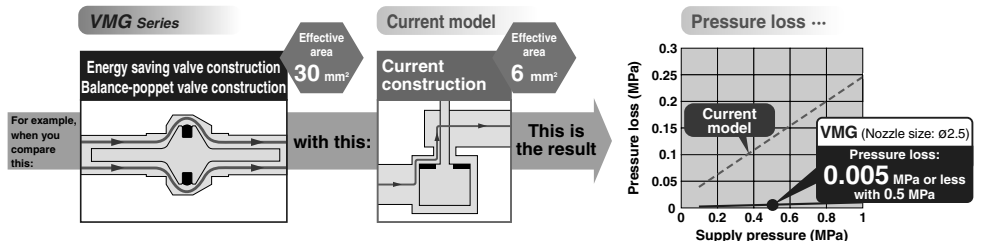



SMC helps you work toward a revolutionized production system with a focus on saving-energy.

Example of Improvement

Review the air-blow job and change to the SMC blow gun, S coupler and coil tube to create a larger effective area.

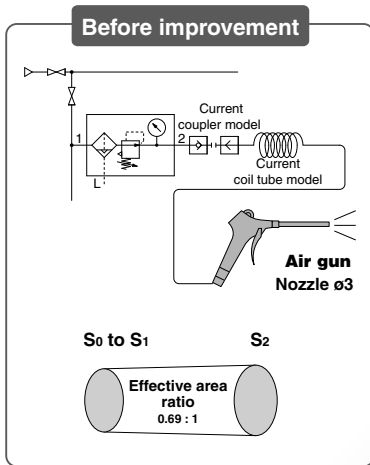
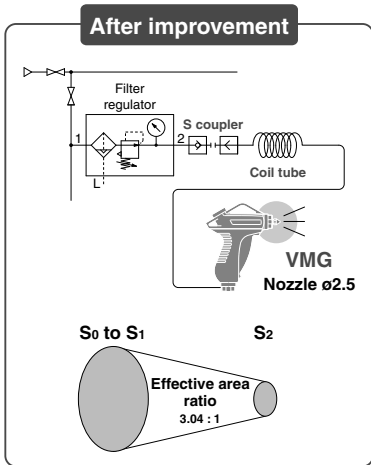

		After improvement	Before improvement
Equipment	Coupler	S coupler	Current model
	Piping	TCU1065-1-20-X6	Current coil tube model (I.D. ø5, equivalent length 5 m)
	Air gun	VMG (Nozzle size ø2.5)	Current model (Nozzle size ø3)
Effective area	Coupler, Piping (S ₀)	13.45 mm ²	5.1 mm ²
	Air gun (S ₁)	30 mm ²	6 mm ²
	Nozzle (S ₂)	4.4 mm ²	6.3 mm ²
Effective area ratio (S ₀ to S ₁ : S ₂)		3.04 : 1	0.69 : 1
Impact pressure		0.011 MPa (at a distance of 100 mm)	0.011 MPa (at a distance of 100 mm)
Regulator pressure		0.4 MPa	0.5 MPa
Pressure inside nozzle		0.385 MPa	0.276 MPa
Compressor pressure		0.5 MPa	0.6 MPa
Air consumption		257 dm ³ /min (ANR)	287 dm ³ /min (ANR)
Power consumption by compressor		1.25 kW	1.56 kW

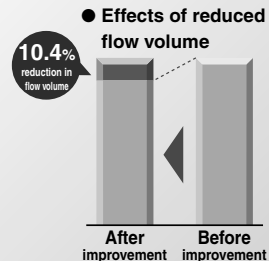
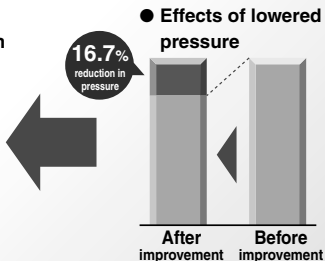
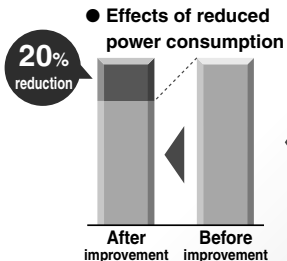

Blow Gun, Coil Tube and S Coupler Selection

Recommended system in accordance with the distance

Energy saving effects are enhanced through the appropriate blow gun model selection in accordance with the distance from the target object.

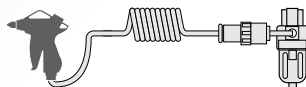

Distance	Recommended system				
	Blow gun	Nozzle size	Fitting	Coil tube*	S coupler
Up to 20 mm	VMG1□□-02-01	ø1	KQ2H06-02AS	TCU0604□-1-20-X6	KK4P-06H
Up to 40 mm	VMG1□□-02-02	ø1.5	KQ2H06-02AS	TCU0604□-1-20-X6	KK4P-06H
Up to 60 mm	VMG1□□-02-03	ø2	KQ2H08-02AS	TCU0805□-1-20-X6	KK4P-08H
Over 60 mm	VMG1□□-02-04	ø2.5	KQ2H10-02AS	TCU1065□-1-20-X6	KK4P-10H

*□: B (Black), W (White), R (Red), BU (Blue), Y (Yellow), G (Green), C (Clear), YR (Orange)

Energy Saving Flow

Air guns with an effective area around 6 mm² are most commonly used. But the SMC blow gun achieves a 30 mm² effective area.

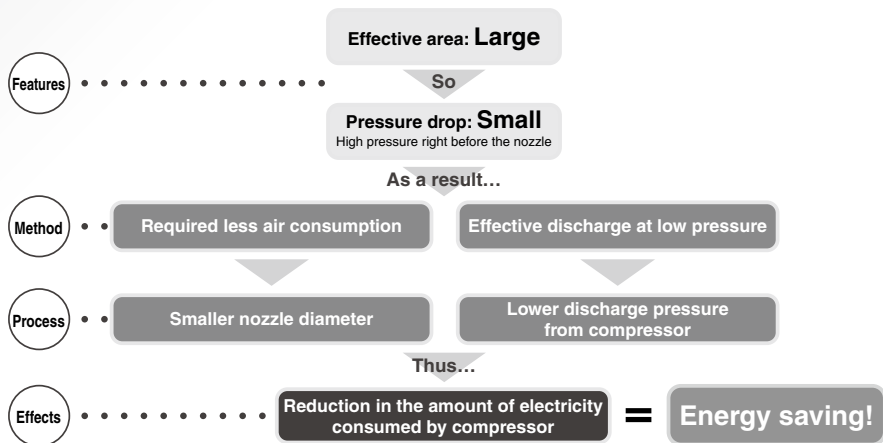

Related Product

For pressure loss improvement **S coupler: KK Series**

Improved fitting's restrictor and leakage



■ **Special method of connection and fixation**

With a structure that employs no steel balls, the coupler achieves a slim body without narrowing of the channel, allowing coverage of a wide effective area.

■ **Smooth channel with minimal unevenness**

By not blocking the channel with the valve spring, the loss of effective area can be minimized.

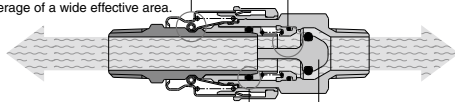

■ **Seal structure with minimal leakage**

The surface-to-surface design allows super-tight sealing.

■ **Conical structure of check valve tip**

This structure achieves smooth flow through the channel.

Variations

Nozzle type

Low noise nozzle

Mono-porous nozzle (ø2) 90 to 100 dB
 ø1 x 4 low noise nozzles 80 dB or less

Note) Supply pressure: 0.5 MPa
 Measured at a 45 degree angle
 according to JIS B 8379



* Achieving lower noise by dividing the air blow slit

Male thread nozzle

Nozzle size: ø1, ø1.5, ø2, ø2.5, ø3, ø3.5, ø4



* Powerful and economical

High efficiency nozzle

This nozzle prevents any pressure buildup when the outlet is blocked for safety.
 (Compliant with OSHA Standards: Operating pressure at 0.5 MPa or less.)



* Makes use of the Bernoulli effect to amplify the air blow flow rate

Copper extension nozzle

Nozzle length: 100 mm, 150 mm, 300 mm, 600 mm

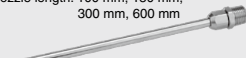

* Secures more power even at a greater distance from a workpiece.



One-touch fitting type



With cover

Cover for male thread nozzle



Cover for copper extension nozzle
 (Outside diameter ø6 only)



Bottom
 <Dark blue>

S coupler plug type

Top
 <White>

Connection type

Screw-in type

Port size

Rc, NPT, G 1/4

Rc, NPT, G 3/8

S coupler plug type

Plug part no.

KK4P-02MS

KK130P-02MS

One-touch fitting type

Applicable tube O.D.

Metric size: ø6, ø8, ø10

Inch size: ø1/4", ø5/16", ø3/8"

With Flow Rate Adjustment Function (Made to Order) p. 1558

The flow rate can be easily adjusted according to the amount of force applied to the lever.

Relationship between the amount of force applied to the lever and the flow rate (Image)

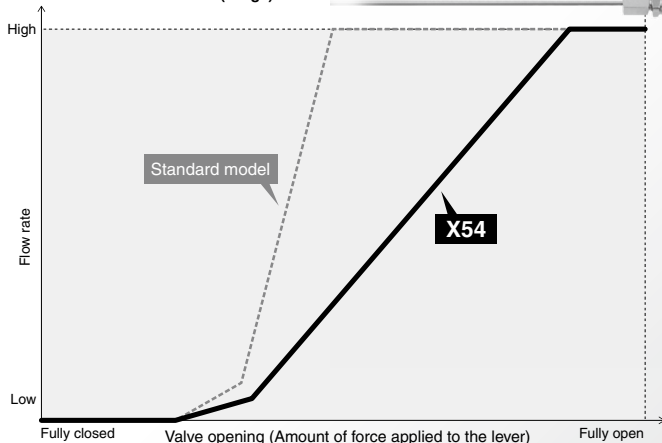

Operability, Safety, Environment

Not affected by supply pressure, assured operability

When using this product even at a high pressure, the same gripping force is required as for a lower pressure due to the unique balance-poppet construction.

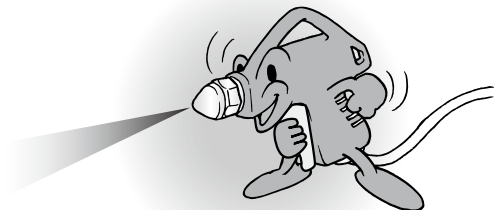

Use of shockresistant resin

Shock-resistant resin is used in the main body. No cracks, breaks or other damage occurred in a drop test from a 2-meter height or in a human stomp test.



Components are separable. Environmentally friendly

Resin parts are inscribed with the name of the material. Additionally, all parts can be separated by material.

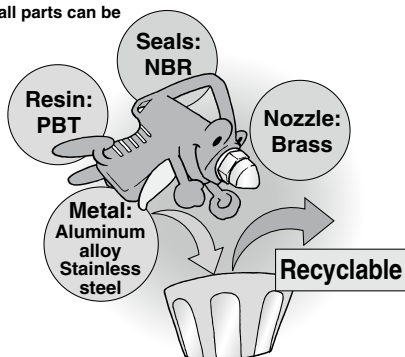

Blow Gun VMG Series

RoHS



How to Order

VMG 1 1 W - 02 - 32 - C

Piping entry

1	Bottom
2	Top

Body color

W	White
BU	Dark blue

Connection size

Symbol	Piping connection method	Size and model no.
02	Threaded	Rc1/4
03		Rc3/8
N02		NPT1/4
N03		NPT3/8
F02		G1/4
F03		G3/8
11	S coupler	Model no. of KK4P-02MS
12	plug	coupler used KK130P-02MS
H06	Metric size One-touch fitting	Model no. of KK2H06-02AS
H08		fitting used KQ2H08-02AS
H10	Inch size One-touch fitting	Model no. of KK2H10-02AS
H07		fitting used KQ2H07-35AS
H09		fitting used KQ2H09-35AS
H11		fitting used KQ2H11-35AS

Note 1) S coupler and fitting are included in the same package.

Note 2) Port size is Rc1/4 if using the S coupler plug.

Note 3) The blow gun port size is Rc1/4 if using the metric size One-touch fitting.

Note 4) The blow gun port size is NPT1/4 if using the inch size One-touch fitting.



Made to Order

(For details, refer to page 1558.)

Symbol	Specifications
-X54	With flow rate adjustment function

With nozzle cover (Only for male thread nozzle, ø6 extension nozzle)

Symbol	None
C	With nozzle cover/HNBR
CF	With nozzle cover/Fluororubber

Nozzle

Symbol	Type	Nozzle size	Nozzle part no.
NII		Without nozzle	
01	Male thread nozzle	ø1	KN-R02-100
02		ø1.5	KN-R02-150
03		ø2	KN-R02-200
04		ø2.5	KN-R02-250
05		ø3	VMG1-R02-300
06		ø3.5	VMG1-R02-350
07	High efficiency nozzle	ø4	VMG1-R02-400
11		ø1	KNH-R02-100
12		ø1.5	KNH-R02-150
13	Low noise nozzle with male thread	ø2	KNH-R02-200
21		ø0.75 x 4	KNS-R02-075-4
22		ø0.9 x 8	KNS-R02-090-8
23		ø1 x 4	KNS-R02-100-4
24		ø1.1 x 8	KNS-R02-110-8

Extension nozzle

Symbol	Type	Nozzle length	Nozzle size	Nozzle part no.
31	ø6 copper extension nozzle ^{Note)}	300 mm	ø1.5	VMG1-06-150-300
32			ø2	VMG1-06-200-300
33			ø1.5	VMG1-06-150-600
34		100 mm	ø2	VMG1-06-200-600
35			ø1.5	VMG1-06-150-100
36			ø2	VMG1-06-200-100
37	ø8 copper extension nozzle ^{Note)}	150 mm	ø1.5	VMG1-06-150-150
38			ø2	VMG1-06-200-150
41		100 mm	ø2.5	VMG1-08-250-100
42			ø3	VMG1-08-300-100
43			ø3.5	VMG1-08-350-100
44			ø2.5	VMG1-08-250-150
45	150 mm		ø3	VMG1-08-300-150
46			ø3.5	VMG1-08-350-150
47	300 mm	ø2.5	VMG1-08-250-300	
48		ø3	VMG1-08-300-300	
49		ø3.5	VMG1-08-350-300	
50		ø2.5	VMG1-08-250-600	
51		600 mm	ø3	VMG1-08-300-600
52			ø3.5	VMG1-08-350-600

Note) Part number for set of extension nozzle and fitting. Extension nozzle and fitting are included in the same package.

Refer to "How to attach extension nozzle" in the operation manual for assembly procedures.

Specifications

Fluid	Air
Operating pressure range	0 to 1.0 MPa
Proof pressure	1.5 MPa
Ambient and fluid temperature	-5 to 60°C (No freezing)
Flow rate characteristics (With nozzle removed)	C (dm ³ /s-bar): 6.0, b: 0.25 (Effective area: 30 mm ²)
Port size	Rc, NPT, G 1/4, 3/8
Piping entry	Bottom Top
Nozzle port size	Rc1/4
Weight (Main unit only)	165 g
Operational force (when the valve is fully open)	7 N

VMG Series

Construction

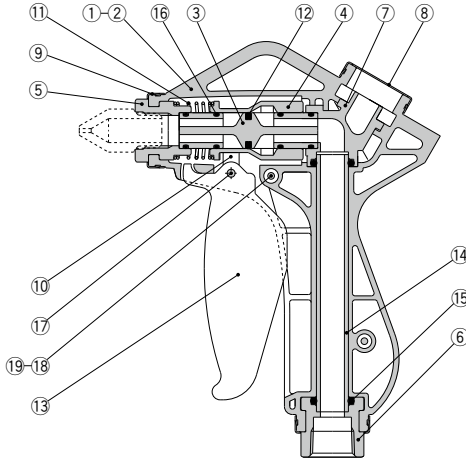

Component Parts

No.	Description	Material	Note
1	Body L	PBT	
2	Body R	PBT	
3	Main valve	PBT	
4	Valve guide	POM	
5	Nozzle holder	Aluminium alloy	Anodized
6	Port	Aluminium alloy	Anodized
7	Elbow	PBT	Only for the VMG1□
8	Cover	Stainless steel	
9	Ring	Stainless steel	
10	Arm	PBT	
11	Spring	Stainless steel	
12	Main valve seal	HNBR	
13	Lever	PBT	
14	Piping (bottom)	POM	Only for the VMG11□ Combined with the elbow (7).
15	O-ring	NBR	
16	O-ring	NBR	
17	Parallel pin	Stainless steel	
18	Cross recessed round head screw	Stainless steel	
19	Hexagon nut	Stainless steel	

Note) Grease is used on rubber and sliding sections.

Flow Rate Characteristics

Note) Values when the main valve is fully open

Male thread nozzle

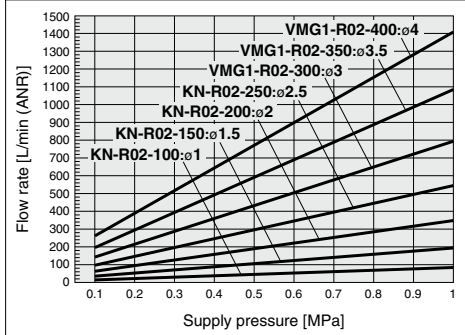

High efficiency nozzle

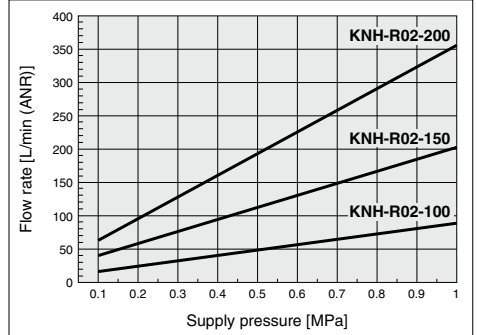

Low noise nozzle with male thread

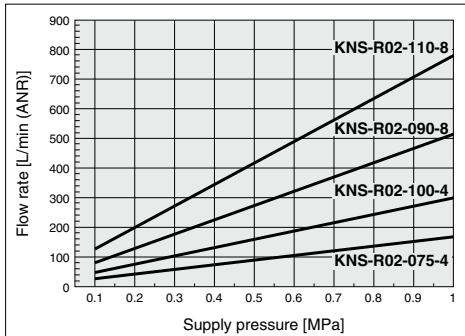

Copper extension nozzle

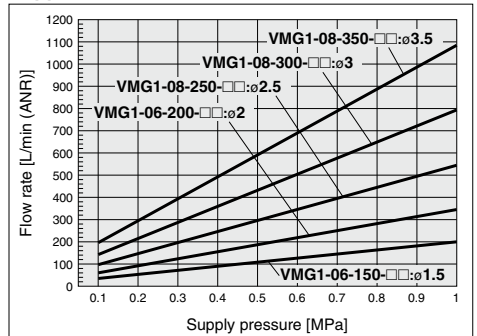

Dimensions

VMG11/Piping entry: Bottom

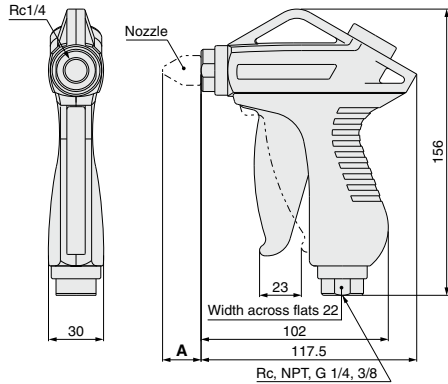

Note) Reference dimensions after installation

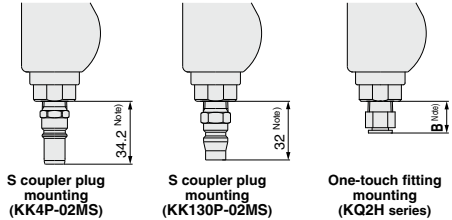

VMG12/Piping entry: Top

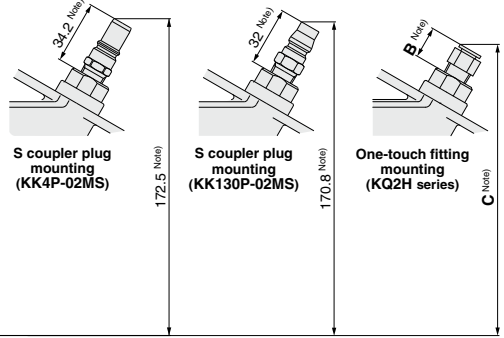
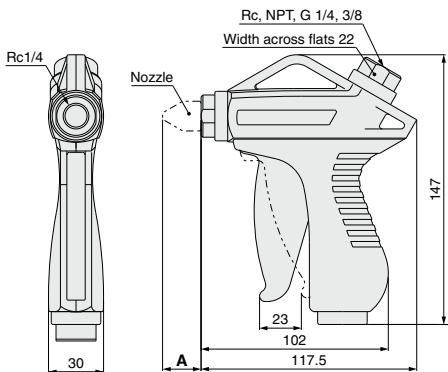

Symbol	Type	Nozzle part no.	Nozzle size	A ^{Note)}	
01	Male thread nozzle	KN-R02-100	ø1	23.4	
02		KN-R02-150	ø1.5	23	
03		KN-R02-200	ø2	22.5	
04		KN-R02-250	ø2.5	22.1	
05		VMG1-R02-300	ø3	22	
06		VMG1-R02-350	ø3.5	21.5	
07		VMG1-R02-400	ø4	21.5	
11	High efficiency nozzle	KNH-R02-100	ø1	44	
12		KNH-R02-150	ø1.5		
13		KNH-R02-200	ø2		
21	Low noise nozzle with male thread	KNS-R02-075-4	ø0.75 x 4	12	
22		KNS-R02-090-8	ø0.9 x 8		
23		KNS-R02-100-4	ø1 x 4		
24		KNS-R02-110-8	ø1.1 x 8		
31	ø6 copper extension nozzle ^{Note)}	Nozzle length: 300 mm	VMG1-06-150-300	ø1.5	298
32		Nozzle length: 600 mm	VMG1-06-200-300	ø2	
33		Nozzle length: 600 mm	VMG1-06-150-600	ø1.5	598
34		Nozzle length: 600 mm	VMG1-06-200-600	ø2	
35		Nozzle length: 100 mm	VMG1-06-150-100	ø1.5	
36		Nozzle length: 100 mm	VMG1-06-200-100	ø2	
37	Nozzle length: 150 mm	VMG1-06-150-150	ø1.5	148	
38	Nozzle length: 150 mm	VMG1-06-200-150	ø2		

Note) Reference dimensions after installation

Symbol	Type	Nozzle part no.	Nozzle size	A ^{Note)}
41	Nozzle length: 100 mm	VMG1-08-250-100	ø2.5	98
42		VMG1-08-300-100	ø3	
43		VMG1-08-350-100	ø3.5	
44		VMG1-08-250-150	ø2.5	
45	Nozzle length: 150 mm	VMG1-08-300-150	ø3	148
46		VMG1-08-350-150	ø3.5	
47	Nozzle length: 300 mm	VMG1-08-250-300	ø2.5	298
48		VMG1-08-300-300	ø3	
49		VMG1-08-350-300	ø3.5	
50		VMG1-08-250-600	ø2.5	
51	Nozzle length: 600 mm	VMG1-08-300-600	ø3	598
52		VMG1-08-350-600	ø3.5	

Type	One-touch fitting model	B ^{Note)}	C ^{Note)}
Metric size One-touch fitting	KQ2H06-02AS	12	153.2
	KQ2H08-02AS	17.3	158.6
	KQ2H10-02AS	22.6	163.8
Inch size One-touch fitting	KQ2H07-35AS	12.3	153.2
	KQ2H09-35AS	17.7	158.9
	KQ2H11-35AS	20.7	162

Note) Reference dimensions after installation

VMG Series

Dimensions: Nozzles/KN Series

Male thread nozzle: KN



Part no.	Nozzle size D	Connection thread	Width across flats H ₁	L ₁	A*
KN-R02-100	ø1	R1/4	14	31.4	25.4
KN-R02-150	ø1.5			31	25
KN-R02-200	ø2			30.5	24.5
KN-R02-250	ø2.5			30.1	24.1
VMG1-R02-300	ø3			30	24
VMG1-R02-350	ø3.5			29.5	23.5
VMG1-R02-400	ø4			29.5	23.5

* Reference dimensions after R thread installation

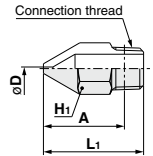

High efficiency nozzle: KNH (Compliant with OSHA Standards: Operating pressure at 0.5 MPa or less.)



Part no.	Nozzle size D	Connection thread	Width across flats H ₁	L ₁	A*	Nozzle diameter identification groove
KNH-R02-100	ø1	R1/4	14	52	46	—
KNH-R02-150	ø1.5					1 pc.
KNH-R02-200	ø2					2 pcs.

* Reference dimensions after R thread installation

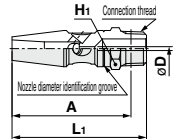

Low noise nozzle with male thread: KNS



Part no.	Nozzle size D	Connection thread	Width across flats H ₁	L ₁	A*
KNS-R02-075-4	ø0.75 x 4	R1/4	14	20	14
KNS-R02-090-8	ø0.9 x 8				
KNS-R02-100-4	ø1 x 4				
KNS-R02-110-8	ø1.1 x 8				

* Reference dimensions after R thread installation

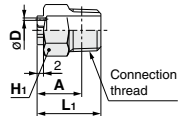

Copper extension nozzle set



Part no.	Nozzle size D	Outside diameter	L ₁	L ₂ (Note 1)	L (Note 1)	Width across flats H ₁		
VMG1-06-150-100	ø1.5	ø6	100	100	106	12		
VMG1-06-200-100	ø2		150	150	156			
VMG1-06-150-150	ø1.5		300	300	306			
VMG1-06-200-150	ø2		600	600	606			
VMG1-06-150-600	ø1.5		ø8	100	100		106	14
VMG1-06-200-600	ø2			150	150		156	
VMG1-08-250-100	ø2.5	300		300	306			
VMG1-08-300-100	ø3	600		600	606			
VMG1-08-350-100	ø3.5	600		600	606			
VMG1-08-250-150	ø2.5							
VMG1-08-300-150	ø3							
VMG1-08-350-150	ø3.5							
VMG1-08-250-300	ø2.5							
VMG1-08-300-300	ø3							
VMG1-08-350-300	ø3.5	600	600	606				
VMG1-08-250-600	ø2.5							
VMG1-08-300-600	ø3							
VMG1-08-350-600	ø3.5							

Note 1) Reference dimensions after installation

Note 2) Copper extension nozzle and self-align fitting are included in the same package, (but unassembled).

Refer to "How to attach extension nozzle" in the operation manual for assembly procedures.

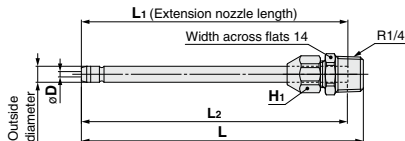

Dimension: Nozzle Cover

Cover for male thread nozzle

(mm)

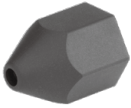

Nozzle cover part no.	Material	Applicable blow gun model	
		Model	Nozzle type
P5670129-01	HNBR	VMG1□□-□-01 to 04	Male thread nozzle ø1 to ø2.5
P5670129-01F	Fluororubber		
P5670129-02	HNBR	VMG1□□-□-05 to 07	Male thread nozzle ø3 to ø4
P5670129-02F	Fluororubber		

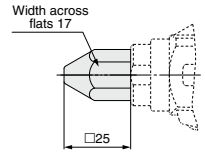

VMG1□□-□-01 to 04

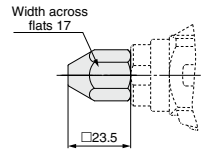

VMG1□□-□-05 to 07

Cover for copper extension nozzle

(mm)



Nozzle cover part no.	Material	Applicable blow gun model	
		Model	Nozzle type
P5670129-11	HNBR	VMG1□□-□-31 to 38	ø6 copper extension nozzle
P5670129-11F	Fluororubber		

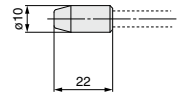

VMG1□□-□-31 to 38

VMG Series Made to Order

Please contact SMC for detailed dimensions, specifications, and delivery times.



1 With Flow Rate Adjustment Function

Symbol
-X54

The flow rate can be easily adjusted according to the amount of force applied to the lever.

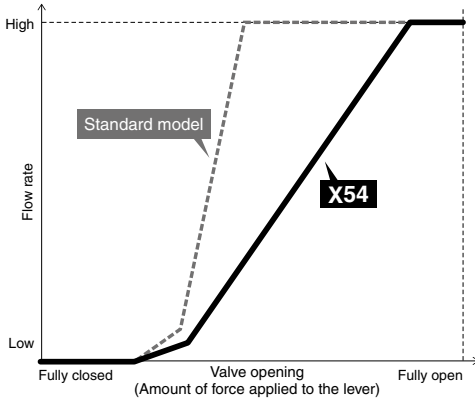

How to Order

VMG11 [] - [] - [] - C - X54

Enter the standard product number.

- With flow rate adjustment function
- With nozzle cover (Only for male thread nozzle, $\phi 6$ extension nozzle)

Nil	None
C	With nozzle cover/HNBR
CF	With nozzle cover/Fluororubber

Specifications

Flow rate characteristics (With nozzle removed)	C ($\text{dm}^3/\text{s} \cdot \text{bar}$): 3.3 *1 (Effective area: 16.5 mm^2)
Piping entry	Bottom
Operational force (when the valve is fully open)	9 N *2

*1) Though the value is smaller than that of the standard model, the flow rate characteristics when a nozzle is mounted are the same as those of the standard model.

*2) The operational force is higher than that of the standard model for ease of flow adjustment with the lever.

Dimensions

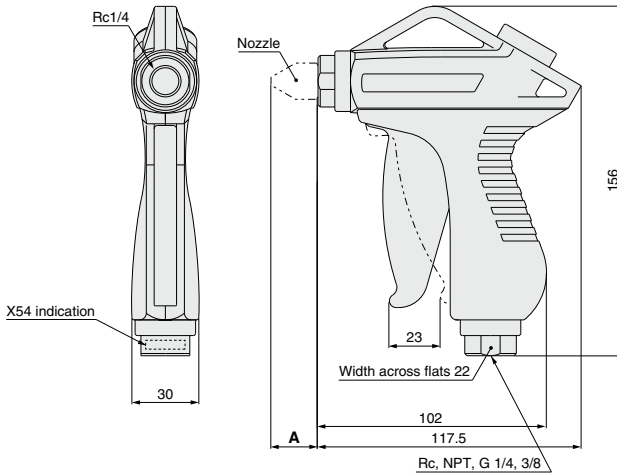



VMG Series

Specific Product Precautions 1

Be sure to read this before handling the products.

Selection

⚠ Warning

1. Check the specifications.

The products in this catalog are designed to be used in compressed air systems only. If the products are used in an environment where pressure or temperature is out of the specified range, damage and/or malfunction may result. Do not use under such conditions.

⚠ Caution

1. Do not apply the blow gun to flammable, explosive or toxic substances such as gas, fuel gas or refrigerant. Such substances may exude from inside the blow gun.

Mounting

⚠ Warning

1. Install a stop valve on the supply pressure side of the blow gun to enable emergency shut off in case of unexpected leakage or damage.
2. When installing a nozzle on the blow gun, wrap pipe tape around the threads of the nozzle.
3. When installing the nozzle, secure the nozzle holder of the blow gun by applying a wrench of 22 mm width across flats to the two chamfered surfaces of the holder without applying force to the body. Then, tighten the nozzle with force within the torque range below. As a guideline, it is equivalent to 2 to 3 additional turns with a tool after manual tightening.

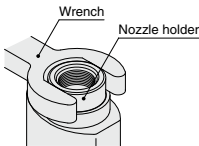

Nozzle tightening torque range	12 to 14 N·m
--------------------------------	--------------

Insufficient tightening may cause loosening of the nozzle.

Piping

⚠ Caution

1. Check the model, type and size before installation.

Also, confirm that there is no scratches, gouges or cracks on the product.

2. Before piping

Before piping, it should be thoroughly blown out with air (flushing) or washed to remove chips, cutting oil and other debris from inside the pipe.

Piping

⚠ Caution

3. Winding of sealant tape

When screwing together pipes and fittings, etc., be certain that chips from the pipe threads and sealing material do not get inside the blow gun. Also, when the sealant tape is used, leave 1.5 to 2 thread ridges exposed at the end of the threads.

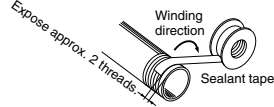

4. When tightening the threads, secure the nozzle holder of the blow gun by applying a wrench of 22 mm width across flats to the two chamfered surfaces of the holder without applying force to the body. Then, tighten the nozzle with torque specified in the table below. As a guideline, it is equivalent to 2 to 3 additional turns with a tool after manual tightening.

Be careful that tightening with torque beyond the ranges in the table below may cause damage to the body.

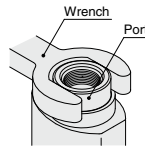

Male thread	Tightening torque N·m
R1/4	12 to 14
R3/8	22 to 24

5. Allow extra length when connecting a tube to accommodate changes in tube length due to pressure.
6. Confirm that no twisting, turning or tensile force or moment load is applied to the port or tube. This may cause fittings to fracture or tubes to be crushed, burst or come loose.
7. Do not abrade, entangle or scratch the tube. This may cause the tube to be crushed, burst or come loose.

Lubrication

⚠ Warning

1. Do not lubricate the product.

It may contaminate or damage the target object.

Air Supply

⚠ Warning

1. Use clean air.

Do not use compressed air which includes chemicals, synthetic oils containing organic solvents, salt or corrosive gases, etc., as it can cause damage or malfunction.



VMG Series

Specific Product Precautions 2

Be sure to read this before handling the products.

Air Supply

Caution

1. Install air filters.

Install air filters at the upstream side of blow gun. Choose the filtration degree of 5 μm or finer.

2. Install an after-cooler, air dryer or water droplet separator, etc.

Air excessive drainage may cause a malfunction of blow gun and contaminate or damage the target object. To prevent this, install an after-cooler, air dryer or water droplet separator, etc.

Operating Environment

Warning

- 1. Do not use in an atmosphere of corrosive gases, chemicals, sea water, water or water vapor or in an environment where such substances may adhere.**
- 2. Provide shading in an environment where the product is exposed to the sunlight.**
- 3. Do not use in an environment where a heat source is at a close distance.**
- 4. Do not use in an environment where static electricity is a problem. It may cause malfunction or failure of the system. Please contact SMC for use in such an environment.**
- 5. Do not use in an environment where spatters are generated. There is danger of fires caused by spattering. Please contact SMC for use in such an environment.**
- 6. Do not use in an environment where the product is exposed to cutting oil, lubricating oil or coolant oil. Please contact SMC for use in an environment where the product is exposed to such liquid as cutting oil, lubricating oil or coolant oil.**

Maintenance

Caution

- 1. In periodical inspections, check the following items and replace the parts if necessary.**
 - a) Scratches, gouges, abrasion, corrosion
 - b) Air leakage
 - c) Twisting, crushing and turning of connected tubes
 - d) Hardening, deterioration and softening of connected tubes
 - e) Loosening of nozzles
- 2. When removing the product, first stop the pressure supply, exhaust compressed air in the piping and check the condition of atmospheric release.**
- 3. Do not disassemble or remodel the body of the product.**

Handling

Warning

- 1. To prevent lurching of the nozzle due to air pressure, confirm that the nozzle is not loosened or rattling by pulling it by hand before operation.**
- 2. Make sure to wear safety goggles to protect yourself from splashed substances.**
- 3. Do not direct the tip of the nozzle at the face or other parts of a human body. It may cause danger to personnel.**
- 4. Do not use the product to clean or remove toxic substances or chemicals.**
- 5. Do not drop, step on or hit the product. It may cause damage to the product.**
- 6. Do not use the product to disturb public order or public hygiene.**
- 7. This product is not a toy.**
- 8. After blowing, make sure to hang the product on a hook, etc.**

If leaving the product in a dusty place, particles will enter the product and may result in a malfunction.

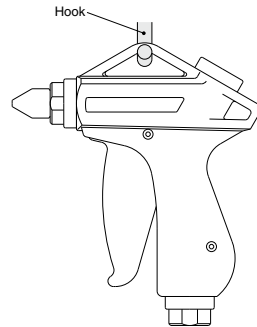

- 9. When the blow gun is used or stored, confirm that no twisting, turning or tensile force or moment load is applied to the port or tube. This may cause fittings to fracture or tubes to be crushed, burst or come loose.**
- 10. When attaching a nozzle cover, align the hex parts of the nozzle and nozzle cover before covering. When attaching an extension nozzle cover, confirm that the nozzle tip is completely inserted into the extension nozzle cover.**
- 11. Do not use a nozzle cover or extension nozzle cover if it is cracked or does not fit securely, and replace with a new cover.**