

4 Port Solenoid Valve Cassette Type Manifold

SJ2000/3000 Series

Rubber Seal

CE c **UL** US RoHS

Plug-in cable type manifold is added !

SJ
SY
SY
S0700
S0700

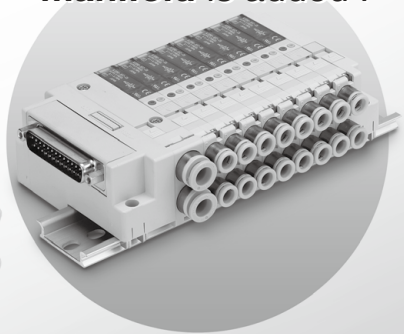
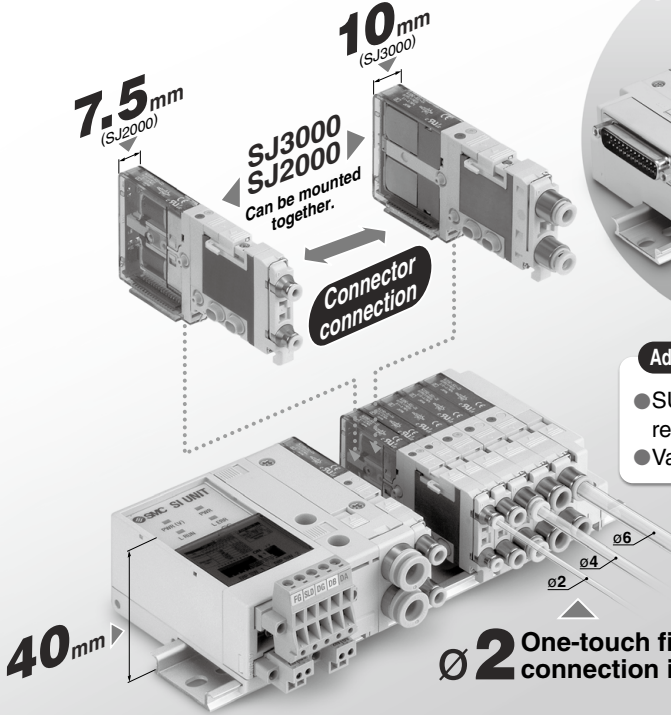

Additional options are now available.

- SUP/EXH block assembly with regulator and pressure switch
- Valve with speed controller

An additional type of manual override is now available.

- Slide locking type

● **Non plug-in type**
Individual wiring manifold

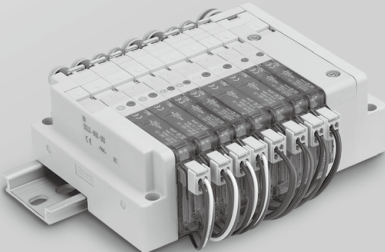

● **Vacuum release valve with restrictor**
Suction and release can be controlled with a single unit.

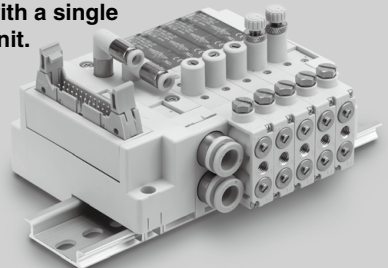

4 Port Solenoid Valve Cassette Type Manifold

● Power consumption

0.15 W * (SJ3000 with power saving circuit)
 0.23 W * (SJ2000 with power saving circuit)
 Note) Refer to page 117 for details.

● Connector type (Card edge type)

SJ2000 and SJ3000 series can be mounted together.

- Can easily increase or decrease stations and replace valves.
- 34 pins connector allows up to 16 stations with double solenoids, 32 stations with single solenoids.



● Non plug-in individual wiring compliant, too

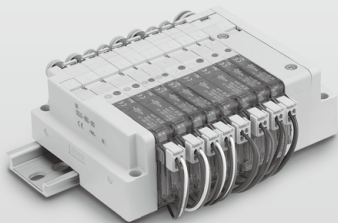

● Manifold uses halogen-free lead wires.

● Plug-in cable type manifold

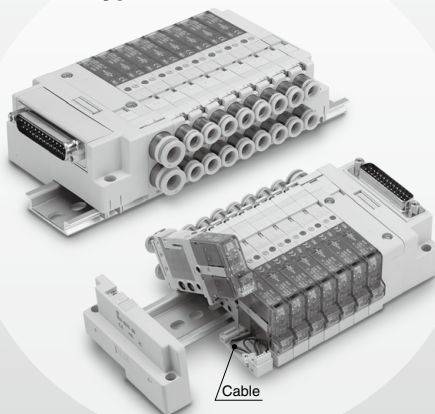

Piping variations

With One-touch fittings

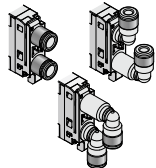

Threaded type



Threaded type is not available for 1(P), 3/5(E) port.

Fittings are replaceable.

Fittings (including type and size) can be easily changed by removing a clip.

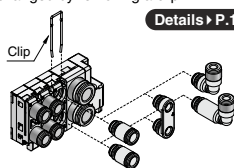

With switch (Connector type)

- Possible to shut the signal of each valves individually.
- Manual operation is possible by switching OFF, even when the valve is in the energized state.

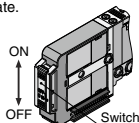

The valve coil is kept in a deenergized state even when there is an electric signal from the manifold side connector, and this enables manifold operation.

Manual locking

Prevents wrong operation by sliding the switch to avoid a manual button from being pressed.

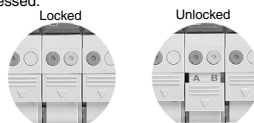

Valve connection mechanism

Connection between valves can be fixed by the valve lock switch. Connection can be confirmed with the connection hook inserted into the connection groove of the adjacent valve.

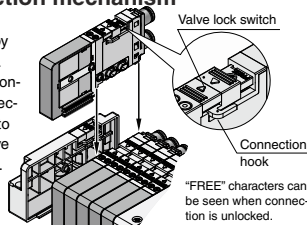

"FREE" characters can be seen when connection is unlocked.

Connector mounting direction

Connector mounting direction can be changed by sliding the switch.

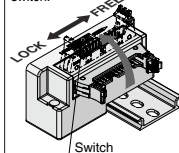

Light indication

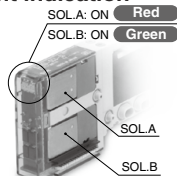

Type of manual override

Non-locking push type

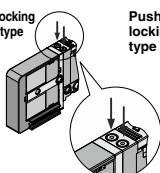

Push-turn locking slotted type

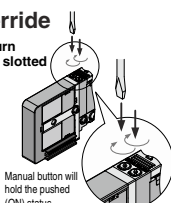

Slide locking type

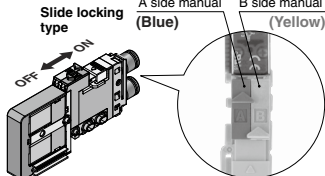

SJ2000/3000 Series



D-sub connector

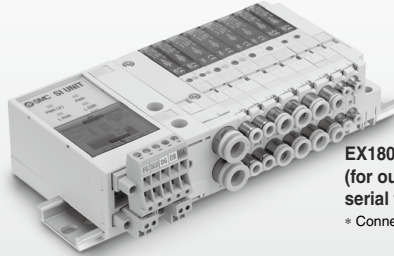
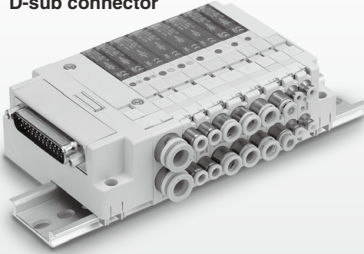

**EX180 Integrated-type
(for output)
serial transmission system**
* Connector type only.

SJ
SY
SY
S0700
S0700

Flat ribbon cable

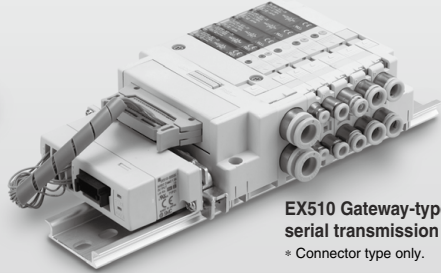
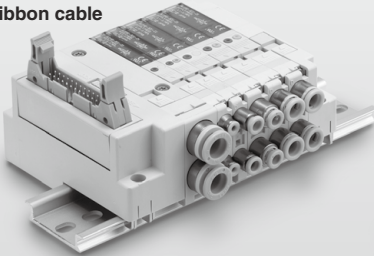

**EX510 Gateway-type
serial transmission system**
* Connector type only.

EX180 Integrated-type (for output) serial transmission system*

* Connector type only.

- **CC-Link (32 outputs), DeviceNet (32, 16 outputs)**
- **Easy attaching/detaching of the SI unit and wiring by the connector**
- Separated valve power unit and transmission power unit/Ensuring safety at maintenance
- Selectable between T-branch and straight type of communication connector

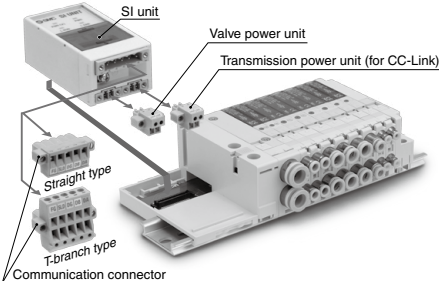

In case of DeviceNet, transmission power unit exists in the communication connector side of T-branch or straight type.

EX510 Gateway-type serial transmission system*

* Connector type only.

- **Max. 128 points (Input 64 points/ Output 64 points)**
- **All wires can be plugged into the connector units.**
- **CC-Link, DeviceNet, PROFIBUS-DP compliant**

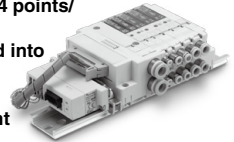

System configuration

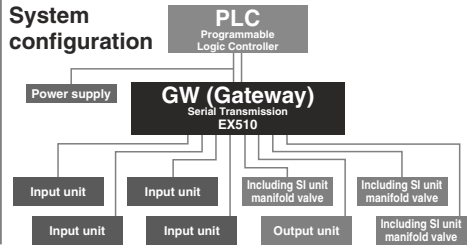

4 position dual 3 port valve

- Integrated to a single valve from 3-port valve
- Possible to control 4(A), 2(B) port individually.
- Can be mounted on the same manifold with a 4-port valve.
- Prepared 3 types of combination
- Label with the same colors of the manual override is attached to show the functions of A side and B side.

A side	B side	Symbol
N.C. valve	N.C. valve	
N.O. valve	N.O. valve	
N.C. valve	N.O. valve	

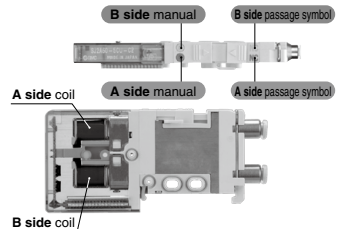

4 Port Solenoid Valve Cassette Type Manifold

Regulator block Details ▶ P.92

This is a regulator block with the same width (10 mm) as the SJ3000. Pressure supplied from the D side is used to reduce pressure in the manifold. The U side valves are all depressurized from the regulator block.

Regulator block

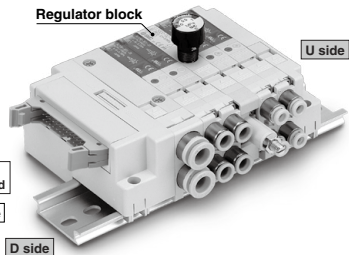

● Pneumatic circuit (example of regulator block installation)

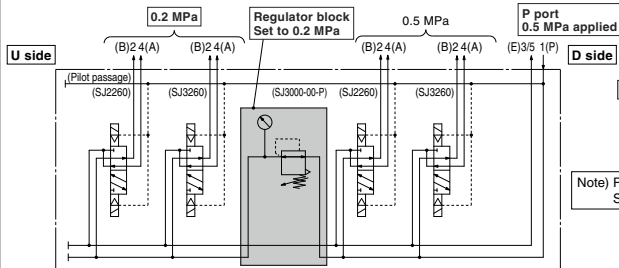

(Note) Reduces supply pressure from the D side of the manifold. Supply pressure from the U side cannot be reduced.

● Both the pressure gauge mounting position and the method of operating the pressure adjustment screw can be selected.

SJ3000-00-P(H)

SJ3000-01-P(H)

SJ3000-M1-P(H)

With manual operation of the pressure adjustment screw

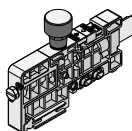

Pressure gauge, top mounting

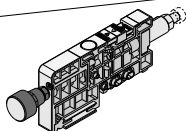

Pressure gauge, side mounting

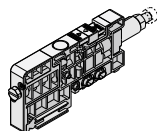

Without pressure gauge

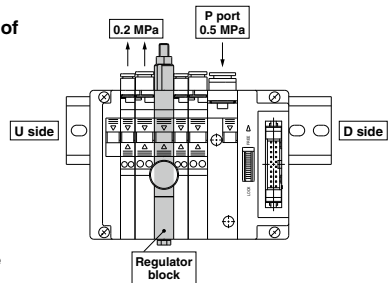

Intermediate connector block assembly Details ▶ P.98

This connector block can be used by inserting it into the middle of the manifold. This can be used, for example, when you wish to separate electrical control of valves in the same manifold, or when the number of control points is insufficient.

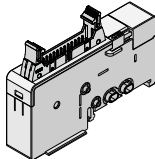

Intermediate connector block assembly

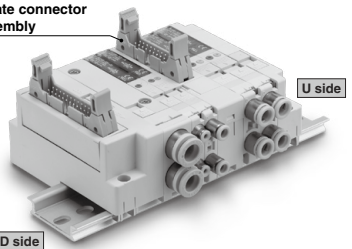

● Intermediate connector block assembly wiring example

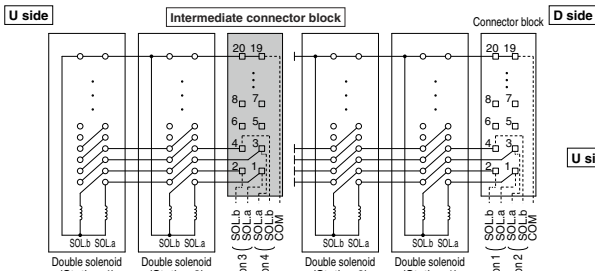

* The U side solenoid valves can be controlled from the position where the intermediate connector block assembly is mounted.

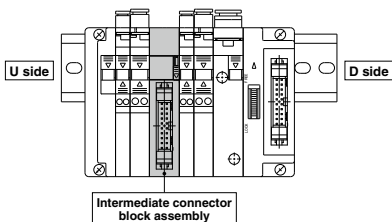

SUP/EXH block assembly with regulator and pressure switch

Details ▶ P.94

This pressure regulator is intended to adjust the SUP pressure of the manifold. Additionally, pressure switch and pressure gauge can be mounted.

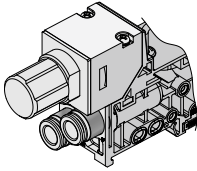

Lateral handle

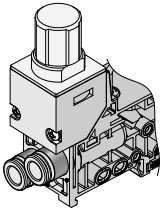

Upward handle

SUP/EXH block assembly with regulator and pressure switch

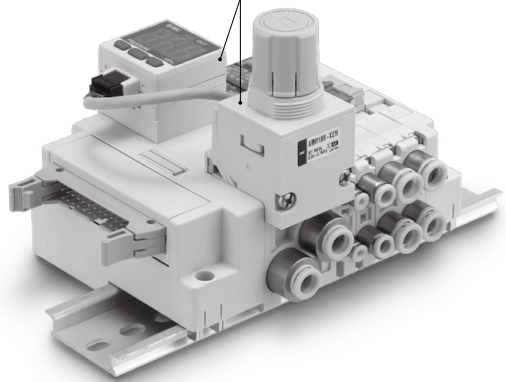

Valve with speed controller

Details ▶ P.94

As a speed controller is built-into this valve, the cylinder speed can be adjusted on the valve side. Two types, meter-in and meter-out, are set.

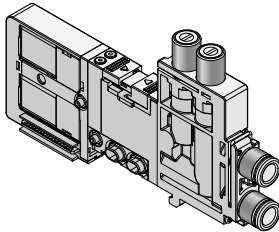

Valve with speed controller
Meter-in: Black
Meter-out: Silver

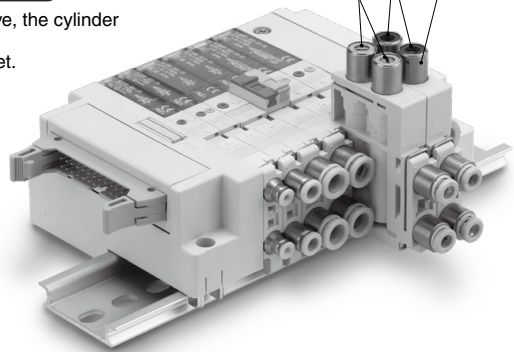

Pneumatic circuit (Installation example of SUP/EXH block assembly with regulator and pressure switch, valve with speed controller)

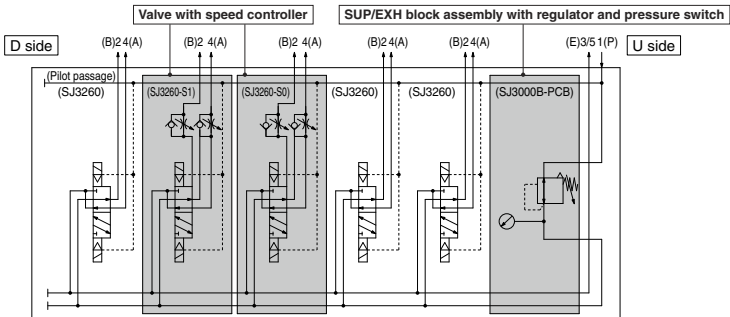

SJ
SY
SY
S0700
S0700

Vacuum Release Valve with Restrictor



RoHS

Two spool valves are built-in.
Vacuum suction and release can be controlled with a single valve.

Plug-in
Connector connection
Cable connection

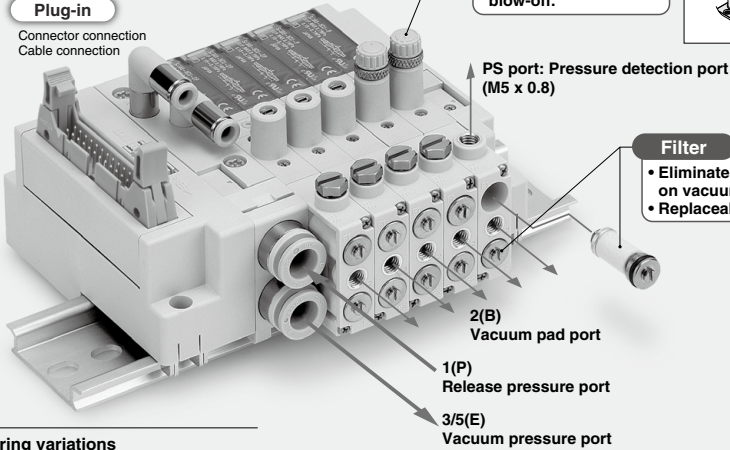

Manual

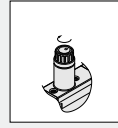

Slotted locking type

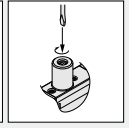

Wiring variations

<Connector connection>

- D-sub connector
- Serial (EX180)
- Flat ribbon cable
- Serial (EX510)

<Cable connection>

- D-sub connector
- Flat ribbon cable

Non plug-in

- Individual wiring

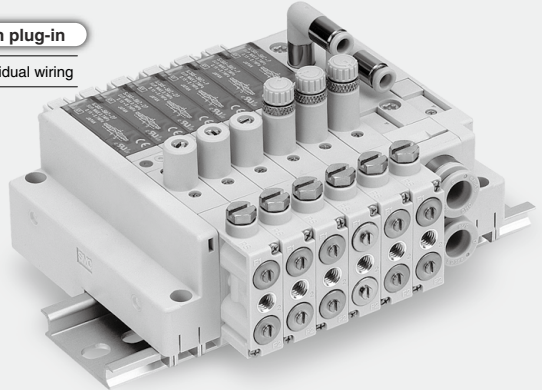

SJ3A6 Series

- Power consumption 0.15 W * (with power saving circuit)
- Width: 10 mm (same as SJ3000 series)
- Equipped with restrictor to enable flow rate adjustment of release air.
- Replaceable filters are built-in on the vacuum and release sides.
- Equipped with a pressure detection port enabling connection of a pressure switch, etc.
- Can be combined with 4 port solenoid valve, SJ2000/3000 series (Special order).
(Please consult with SMC.)
- Enables 2-system pressure switching where the 1(P) port and 3/5(E) are set to different positive pressures.
(In this case, flow can be adjusted on the P-port side only.)

Note) Refer to page 117 for details.

Adsorbing and Transferring System Circuit Example

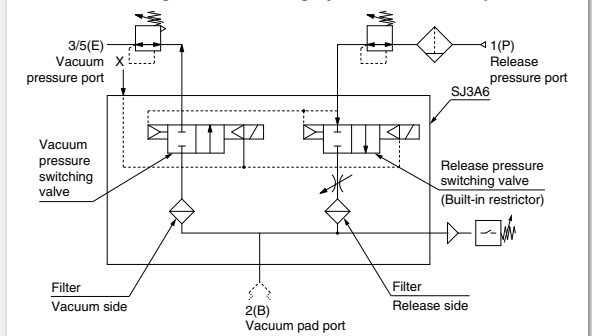

● 4 Port Solenoid Valve *SJ2000/3000 Series*

Common Specifications P.22
Construction P.25

Plug-in Connector Type Manifold
P.33 Cable Type Manifold

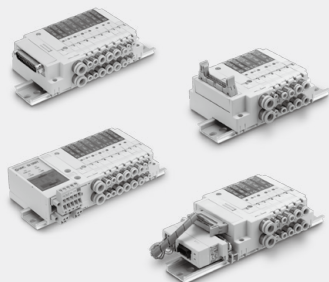

D-sub Connector/Flat Ribbon Cable
 How to Order/Connector Type P.34
 How to Order/Cable Type P.36
 Manifold Electrical Wiring/Connector Type, Cable Type P.38
 Dimensions/Connector Type, Cable Type P.40
EX180 Integrated-type (For Output) Serial Transmission System
 How to Order/Connector Type P.60
 Dimensions/Connector Type P.62
EX510 Gateway-type Serial Transmission System
 How to Order/Connector Type P.68
 Dimensions/Connector Type P.70
Manifold Exploded View/Connector Type, Cable Type P.75, 76
How to Increase Manifold Stations/Connector Type, Cable Type P.77, 78

SJ
SY
SY
S0700
S0700

Non plug-in Individual Wiring Manifold
P.79



Individual Wiring
 How to Order P.80
 Dimensions P.82
Manifold Exploded View/Individual Wiring P.87

Manifold Options P.88
Made to Order P.99

● Vacuum Release Valve with Restrictor *SJ3A6 Series* P.101

Common Specifications P.102
Construction P.103

Plug-in Connector Type Manifold
Cable Type Manifold

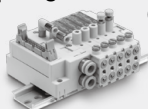

D-sub Connector/Flat Ribbon Cable
Serial Wiring (EX180/EX510)
 How to Order/Connector Type P.104
 How to Order/Cable Type P.106
 Dimensions/Connector Type, Cable Type P.108
Manifold Exploded View/Connector Type, Cable Type ... P.75, 76

Non plug-in Individual Wiring Manifold







Individual Wiring
 How to Order P.110
 Dimensions P.112
Manifold Exploded View/Individual Wiring P.113

Specific Product Precautions P.115

Manifold Variations

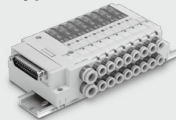
4 Port Solenoid Valve SJ2000/3000 Series

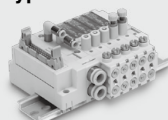
Vacuum Release Valve with Restrictor SJ3A6 Series

Manifold type			Items	Connection method				
				Parallel wiring		Serial wiring		Individual wiring
			D-sub connector	Flat ribbon cable connector	EX180 (For output)	EX510 (Gateway-type)		
4 port solenoid valve	Plug-in	Connector Type 	SS5J2/3-60□	● P.34	● P.34	● P.60	● P.68	Note 1) ● P.35 P.53 P.61 P.69
		Cable Type 	SS5J2/3-60L□	● P.36	● P.36	—	—	—
	Non plug-in		SS5J2/3-60-□	—	—	—	—	● P.81
Vacuum release valve with restrictor	Plug-in	Connector Type 	SS3J3-60□	● P.104	● P.104	● P.104	● P.104	Note 1) ● P.105
		Cable Type 	SS3J3-60L□	● P.106	● P.106	—	—	—
	Non plug-in		SS3J3-60-□	—	—	—	—	● P.111

Note 1) A linkage printed circuit board is built-into the individual wiring valve so as to combine with the plug-in type.

Note 2) Specify the required specifications in the manifold specification sheet.

Note 3) The all single wiring or all double wiring can be specified.

Note 4) The vacuum release valve uses only the double wiring.

Note 5) Only SJ3000 size is provided.

Note 6) Adding 1 additional station is possible up to the maximum number of stations.

Manifold options											Solenoid valve specifications				
Mixed wiring Single/Double	Mixed type M60 SJ2000/3000	Different pressure pneumatic circuit diagram/ Block disk assembly	Blanking block assembly	Dual flow fitting	Regulator block	SUP/EXH block assembly with regulator and pressure switch	Valve with speed controller	Intermediate connector block assembly	Increase of manifold stations	Voltage suppressor			With individual switch	Main valve fluororubber specifications	
										Non-polar	+/- common Polar	With power saving circuit			
Note 2) ●	● P.34	● P.88	● P.89	Note 5) ● P.91	● P.92	● P.94	Note 5) ● P.94	● P.98	● P.77	●	●	●	●	● P.99	
Note 3) —	—	● P.88	● P.89	Note 5) ● P.91	—	—	Note 5) ● P.94	—	Note 6) ● P.78	—	●	●	—	● P.99	
●	● P.80	● P.88	● P.89	Note 5) ● P.91	● P.92	● P.94	Note 5) ● P.94	—	● P.77	—	●	—	—	● P.99	
Note 4) —	—	● P.88	● P.89	—	—	—	—	● P.98	● P.77	●	●	●	●	● P.99	
Note 4) —	—	● P.88	● P.89	—	—	—	—	—	Note 6) ● P.78	—	●	●	—	● P.99	
Note 4) —	—	● P.88	● P.89	—	—	—	—	—	● P.77	—	●	—	—	● P.99	

SJ
SY
SY
S0700
S0700

4 Port Solenoid Valve SJ2000/3000 Series



Common Specifications 1

Manifold Specifications

Model	D-sub connector		Flat ribbon cable				Serial wiring		Individual wiring
	Type 60F (Connector type/ Cable type)	Type 60P (Connector type/ Cable type)	Type 60PG (Connector type/ Cable type)	Type 60PH (Connector type/ Cable type)	Type 60S□ EX180/ (Connector type)	Type 60S6B EX510/ (Connector type)	Type 60		
Manifold type	Plug-in, Connector type/Cable type				Plug-in, Connector type		Non plug-in		
1(P: SUP), 3/5(E: EXH)	Common SUP, EXH								
Valve stations	Connector type: 1 to 24 stations Cable type: 2 to 20 stations		1 to 18 stations (Type PG)	1 to 8 stations	1 to 32 stations	1 to 16 stations	1 to 20 stations		
Applicable connector	D-sub connector Conforming to MIL-C-24308 JIS-X-5101	Flat ribbon cable connector Socket: 26 pins MIL type with strain relief Conforming to MIL-C-83503	Flat ribbon cable connector Socket: 20 pins MIL type with strain relief Conforming to MIL-C-83503	Flat ribbon cable connector Socket: 10 pins MIL type with strain relief Conforming to MIL-C-83503	—	—	—		
Internal wiring	Connector type: non-polar, positive common, negative common/Cable type: positive common, negative common								
4(A), 2(B) port piping spec.	Location	Valve							
	Direction	Horizontal, Upward, Downward (Using elbow fittings for upward or downward)							
Port size	1(P), 3/5(E) port		C6, C8, N7, N9 (Inch size elbow fitting is not available.)						
	4(A), 2(B) port	SJ2000	C2, C4, N1, N3, M3						
		SJ3000	C2, C4, C6, N1, N3, N7, M5						
Weight W (g)^{Note 2)} (n: Number of SUP/EXH blocks m: Weight of DIN rail)		W = 51n + m + 133							

Note 1) When many valves are operated simultaneously, use B type (SUP/EXH both sides), applying pressure to the 1(P) ports on both sides and exhaust from the 3/5(E) ports on both sides.

Note 2) The weight W is the value for the D-sub connector manifold only with internal pilot, SUP/EXH block straight fittings specifications. To obtain the weight with solenoid valves attached, add the solenoid valve weights given on page 24 for the appropriate number of stations. Refer to page 90 for the weight of DIN rail. (Please contact SMC for the weight of external pilot specifications, elbow fittings.)

Flow Rate Characteristics

SJ2000

Port size		Flow rate characteristics					
1(P) 3/5(E)	4, 2 (A, B)	1→2/4 (P→A/B)			4/2→3/5 (A/B→E)		
		C[dm ³ /(s·bar)]	b	Cv	C[dm ³ /(s·bar)]	b	Cv
C8	C2	0.13	0.55	0.04	0.13	0.50	0.04
	C4	0.33	0.16	0.08	0.36	0.13	0.08
	M3	0.18	0.52	0.06	0.20	0.29	0.06

SJ3000

Port size		Flow rate characteristics					
1(P) 3/5(E)	4, 2 (A, B)	1→2/4 (P→A/B)			4/2→3/5 (A/B→E)		
		C[dm ³ /(s·bar)]	b	Cv	C[dm ³ /(s·bar)]	b	Cv
C8	C2	0.13	0.56	0.04	0.14	0.51	0.04
	C4	0.42	0.17	0.11	0.45	0.16	0.11
	C6	0.55	0.10	0.12	0.56	0.11	0.12
	M5	0.40	0.28	0.11	0.45	0.15	0.11

Note) The value is for manifold base with 5 stations and individually operated 2 position type.
Please contact SMC for 4 position dual 3 port valves.

Solenoid Valve Specifications



D-sub connector

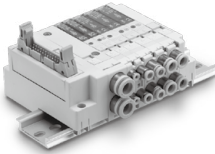

Flat ribbon cable

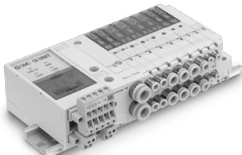

EX180 Integrated-type (for output) serial transmission system

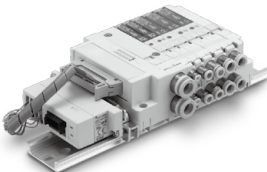

EX510 Gateway-type serial transmission system

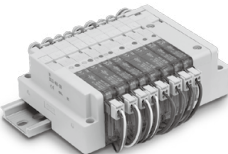

Individual wiring

Fluid		Air	
Internal pilot operating pressure range (MPa)	2 position single	0.15 to 0.7	
	4 position dual 3 port valve		
	2 position double	0.1 to 0.7	
	3 position	0.2 to 0.7	
External pilot operating pressure range (MPa)	Operating pressure range		
	Pilot pressure range	2 position single	0.25 to 0.7
		2 position double	
		3 position	
Ambient and fluid temperature (°C)		-10 to 50 (No freezing)	
Maximum operating frequency (Hz)	2 position single, double	10	
	4 position dual 3 port valve		
	3 position	3	
Manual override (Manual operation)		Non-locking push type Push-turn locking slotted type	
Pilot exhaust method	Internal pilot	Main and pilot valve common exhaust	
	External pilot	Pilot valve individual exhaust	
Lubrication		Not required	
Mounting orientation		Unrestricted	
Impact/Vibration resistance (m/s²)		150/30	
Enclosure		Dustproof	

Note) Impact resistance: No malfunction occurred when it is tested with a drop tester in the axial direction and at the right angles to the main valve and armature in both energized and de-energized states every once for each condition. (Value in the initial state)

Vibration resistance: No malfunction occurred in one sweep test between 45 and 2000Hz. Test was performed to axis and right angle directions of the main valve when pilot signal is ON and OFF. (Value in the initial state)

Solenoid Specifications

Coil rated voltage		24 VDC, 12 VDC	
Allowable voltage fluctuation		±10% of rated voltage *	
Power consumption (W)	Standard	SJ2000	0.55
		SJ3000	0.4
	With power saving circuit (Continuous duty type)	SJ2000	0.23 * [Starting 0.55, Holding 0.23]
		SJ3000	0.15 * [Starting 0.4, Holding 0.15]
Surge voltage suppressor		Diode	
Indicator light		LED	

* For the allowable voltage fluctuation for Z and T types (with power saving circuit), please observe the following range because they have voltage drop due to internal circuit.

Z type 24 VDC: -7% to +10%

12 VDC: -4% to +10%

T type 24 VDC: -5% to +10%

12 VDC: -6% to +10%

Note) Refer to page 117 for details.

Response Time

Type of actuation	Response time ms (at 0.5 MPa)	
	SJ2000	SJ3000
2 position single	16 or less	16 or less
2 position double	10 or less	10 or less
3 position	34 or less	22 or less
4 position dual 3 port valve	30 or less	30 or less

Note) Based on dynamic performance test, JIS B 8419: 2010. (Coil temperature: 20°C, at rated voltage)

4 Port Solenoid Valve SJ2000/3000 Series

Common Specifications 2

Weight

Model/SJ2000

Valve model	Type of actuation		Port size 4(A), 2(B)	Weight (g)
SJ2□60-C2	2 position	Single	C2 ø2 One-touch fitting	43
		Double		46
	3 position	Closed center		50
		Exhaust center		
		Pressure center		
4 position	Dual 3 port valve	46		
SJ2□60-C4	2 position	Single	C4 ø4 One-touch fitting	41
		Double		44
	3 position	Closed center		48
		Exhaust center		
		Pressure center		
4 position	Dual 3 port valve	44		
SJ2□60-M3	2 position	Single	M3 x 0.5	39
		Double		42
	3 position	Closed center		46
		Exhaust center		
		Pressure center		
4 position	Dual 3 port valve	42		

Note) Please contact SMC for the weight of elbow fittings.

Model/SJ3000

Valve model	Type of actuation		Port size 4(A), 2(B)	Weight (g)
SJ3□60-C2	2 position	Single	C2 ø2 One-touch fitting	63
		Double		71
	3 position	Closed center		75
		Exhaust center		
		Pressure center		
4 position	Dual 3 port valve	71		
SJ3□60-C4	2 position	Single	C4 ø4 One-touch fitting	65
		Double		73
	3 position	Closed center		77
		Exhaust center		
		Pressure center		
4 position	Dual 3 port valve	73		
SJ3□60-C6	2 position	Single	C6 ø6 One-touch fitting	61
		Double		69
	3 position	Closed center		73
		Exhaust center		
		Pressure center		
4 position	Dual 3 port valve	69		
SJ3□60-M5	2 position	Single	M5 x 0.8	57
		Double		65
	3 position	Closed center		69
		Exhaust center		
		Pressure center		
4 position	Dual 3 port valve	65		

Note) Please contact SMC for the weight of elbow fittings.

Connector Wiring Diagram

For both serial and parallel wiring, additional valves are sequentially assigned pins on the connector.

This makes it completely unnecessary to disassemble the connector unit.

■ Single solenoid and double solenoid

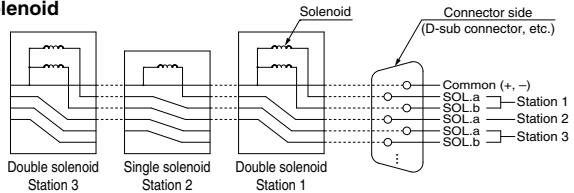

■ Single solenoid with double wiring spec.

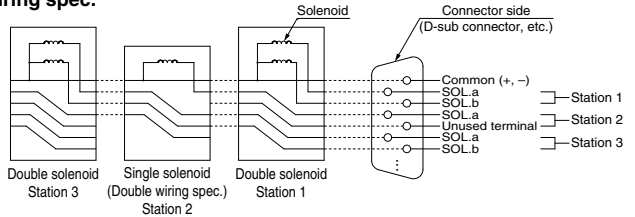

■ Mounting a valve with individual wiring

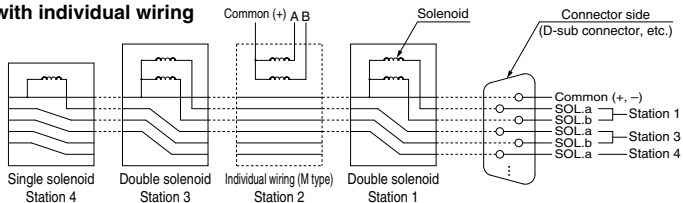

SJ2000/3000 Series Construction 1

SJ2000: Connector Type

Symbol

2 position single

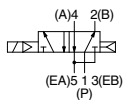

2 position single with back pressure check valve

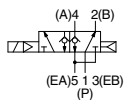

2 position double

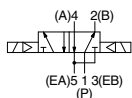

2 position double with back pressure check valve

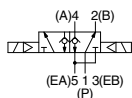

3 position closed center

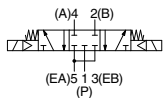

3 position exhaust center

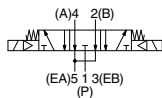

3 position pressure center

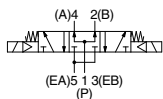

2 position single

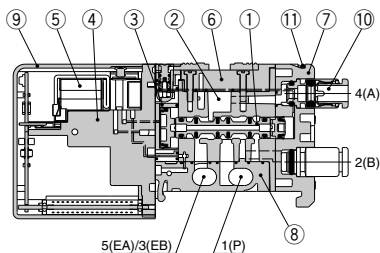

2 position double

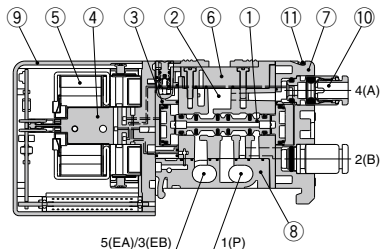

3 position closed center/exhaust center/pressure center

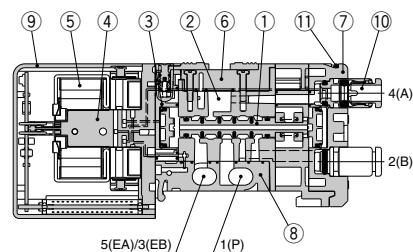

Component Parts

No.	Description	Material	Note
1	Spool valve assembly	Resin/HNBR (3 position solenoid valve: Aluminum/HNBR)	—
2	Body	Zinc die-cast	—
3	Adapter plate	Resin	White
4	Pilot adapter	Resin	White
5	Pilot valve assembly	—	—
6	Body cover	Resin	White
7	Port block	Resin	White
8	Bottom cover	Resin	White
9	Light cover	Resin	Light blue

Replacement Parts

No.	Description	Part no.
10	One-touch fitting	Refer to the One-touch fitting part no. on page 118.
11	Clip	SJ2000-CL-1 (10 pcs.)

SJ2260K with back pressure check valve

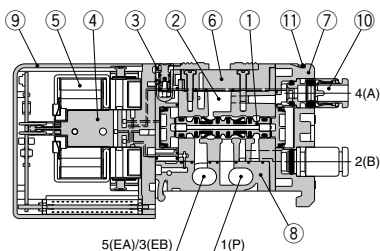

SJ

SY

SY

S0700

S0700

SJ2000/3000 Series Construction 2

SJ2000: Connector Type

Symbol

4 position dual 3 port valve
SJ2A60 [N.C. valve x 2]

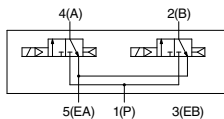

SJ2A60K with back pressure
check valve

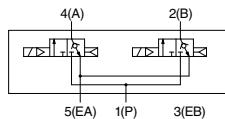

SJ2B60 [N.O. valve x 2]

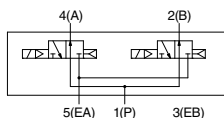

SJ2B60K with back pressure
check valve

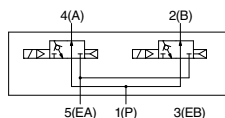

SJ2C60 [N.C., N.O. valve x 1
(each)]

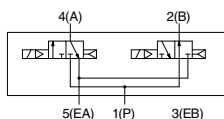

SJ2C60K with back pressure
check valve

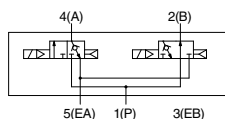

SJ2A60 [N.C. valve x 2]

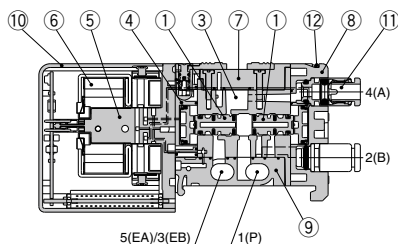

SJ2B60 [N.O. valve x 2]

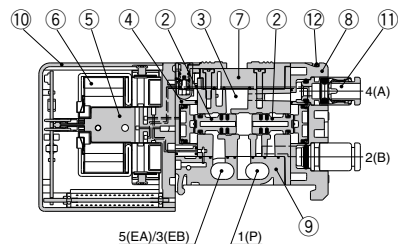

SJ2C60 [N.C. valve, N.O. valve x 1 (each)]

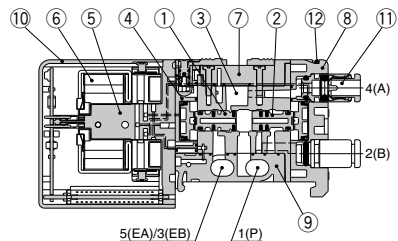

Component Parts

No.	Description	Material	Note
1	Spool valve assembly	Resin/HNBR	N.C. (Normally closed)
2	Spool valve assembly	Resin/HNBR	N.O. (Normally open)
3	Body	Zinc die-cast	—
4	Adapter plate	Resin	White
5	Pilot adapter	Resin	White
6	Pilot valve assembly	—	—
7	Body cover	Resin	White
8	Port block	Resin	White
9	Bottom cover	Resin	White
10	Light cover	Resin	Light blue

Replacement Parts

No.	Description	Part no.
11	One-touch fitting	Refer to the One-touch fitting part no. on page 118.
12	Clip	SJ2000-CL-1 (10 pcs.)

SJ2A60K with back pressure check valve

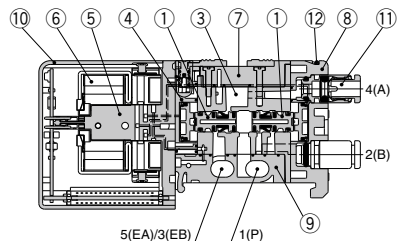

SJ3000: Connector Type

Symbol

2 position single

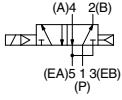

2 position single with back pressure check valve

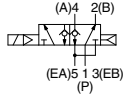

2 position double

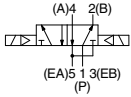

2 position double with back pressure check valve

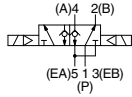

3 position closed center

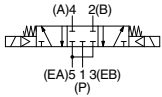

3 position exhaust center

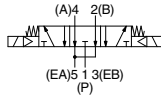

3 position pressure center

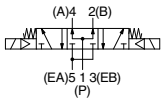

2 position single

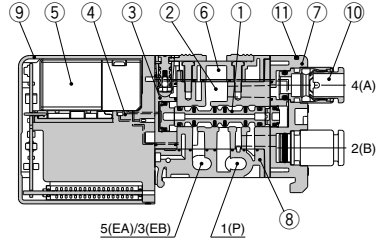

2 position double

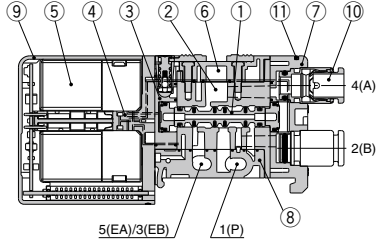

3 position closed center/exhaust center/pressure center

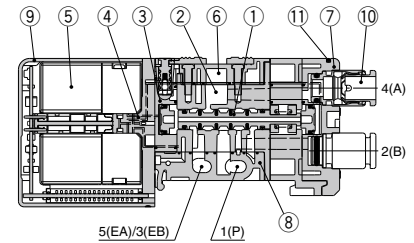

Component Parts

No.	Description	Material	Note
1	Spool valve assembly	Resin/HNBR (3 position solenoid valve: Aluminum/HNBR)	—
2	Body	Zinc die-cast	—
3	Adapter plate	Resin	White
4	Pilot adapter	Resin	White
5	Pilot valve assembly	—	—
6	Body cover	Resin	White
7	Port block	Resin	White
8	Bottom cover	Resin	White
9	Light cover	Resin	Light blue

Replacement Parts

No.	Description	Part no.
10	One-touch fitting	Refer to the One-touch fitting part no. on page 118.
11	Clip	SJ3000-CL-1 (10 pcs.)

SJ3260K with back pressure check valve

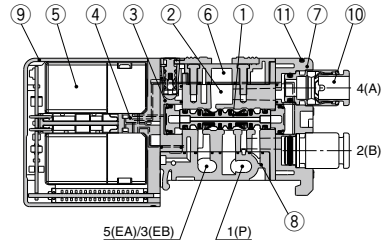

SJ

SY

SY

S0700

S0700

SJ2000/3000 Series Construction 3

SJ3000: Connector Type

Symbol

4 position dual 3 port valve
SJ3A60 [N.C. valve x 2]

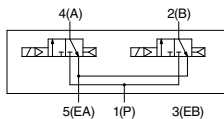

SJ3A60K with back pressure
check valve

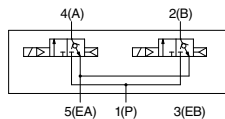

SJ3B60 [N.O. valve x 2]

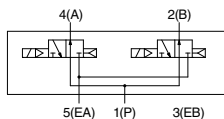

SJ3B60K with back pressure
check valve

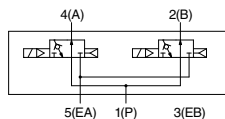

SJ3C60 [N.C., N.O. valve x 1
(each)]

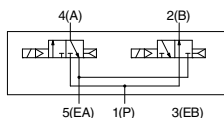

SJ3C60K with back pressure
check valve

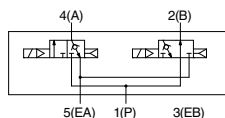

SJ3A60 [N.C. valve x 2]

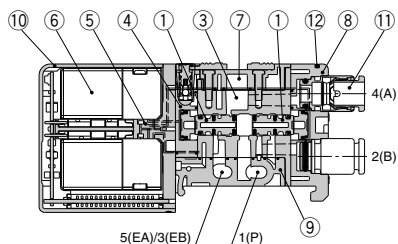

SJ3B60 [N.O. valve x 2]

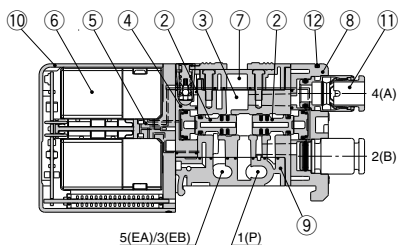

SJ3C60 [N.C. valve, N.O. valve x 1 (each)]

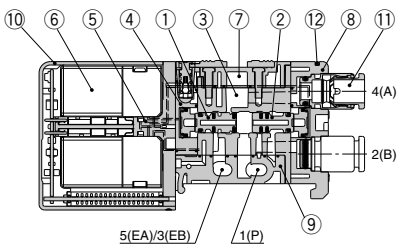

Component Parts

No.	Description	Material	Note
1	Spool valve assembly	Resin/HNBR	N.C. (Normally closed)
2	Spool valve assembly	Resin/HNBR	N.O. (Normally open)
3	Body	Zinc die-cast	—
4	Adapter plate	Resin	White
5	Pilot adapter	Resin	White
6	Pilot valve assembly	—	—
7	Body cover	Resin	White
8	Port block	Resin	White
9	Bottom cover	Resin	White
10	Light cover	Resin	Light blue

Replacement Parts

No.	Description	Part no.
11	One-touch fitting	Refer to the One-touch fitting part no. on page 118.
12	Clip	SJ3000-CL-1 (10 pcs.)

SJ3A60K with back pressure check valve

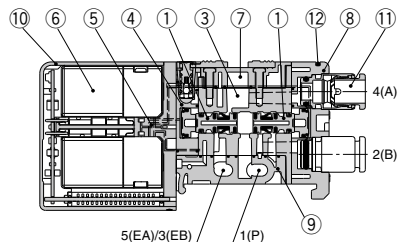

SJ2000: Cable Type

Symbol

2 position single

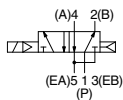

2 position single with back pressure check valve

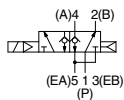

2 position double

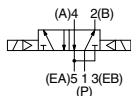

2 position double with back pressure check valve

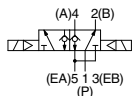

3 position closed center

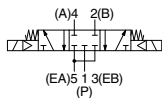

3 position exhaust center

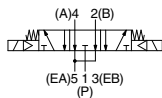

3 position pressure center

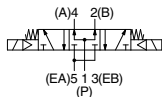

Component Parts

No.	Description	Material	Note
1	Spool valve assembly	Resin/HNBR (3 position solenoid valve: Aluminum/HNBR)	—
2	Body	Zinc die-cast	—
3	Adapter plate	Resin	White
4	Pilot adapter	Resin	White
5	Pilot valve assembly	—	—
6	Body cover	Resin	White
7	Port block	Resin	White
8	Bottom cover assembly	Resin	White
9	Light cover	Resin	Light blue

Replacement Parts

No.	Description	Part no.
10	One-touch fitting	Refer to the One-touch fitting part no. on page 118.
11	Clip	SJ2000-CL-1 (10 pcs.)

2 position single

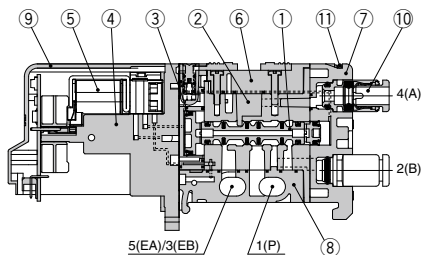

2 position double

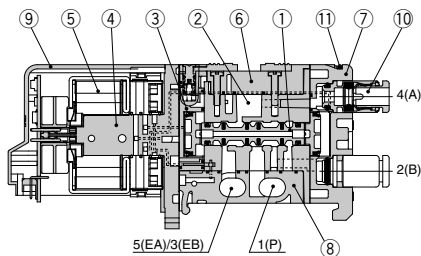

3 position closed center/exhaust center/pressure center

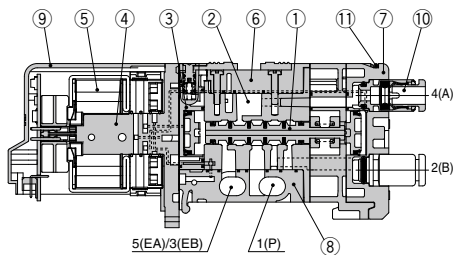

SJ2260K with back pressure check valve

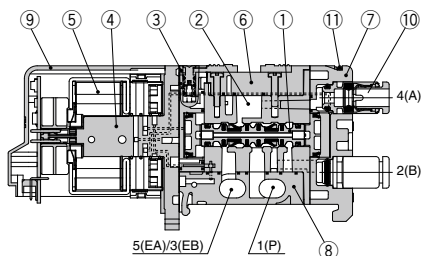

SJ

SY

SY

S0700

S0700

SJ2000/3000 Series Construction 4

SJ2000: Cable Type

Symbol

4 position dual 3 port valve
SJ2A60 [N.C. valve x 2]

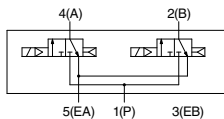

SJ2A60K with back pressure
check valve

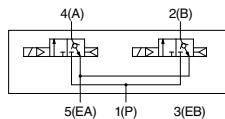

SJ2B60 [N.O. valve x 2]

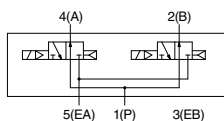

SJ2B60K with back pressure
check valve

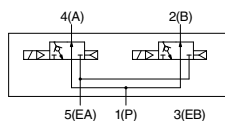

SJ2C60 [N.C., N.O. valve x 1
(each)]

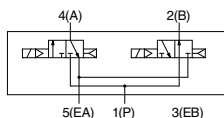

SJ2C60K with back pressure
check valve

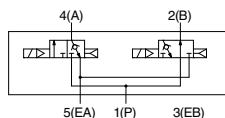

SJ2A60 [N.C. valve x 2]

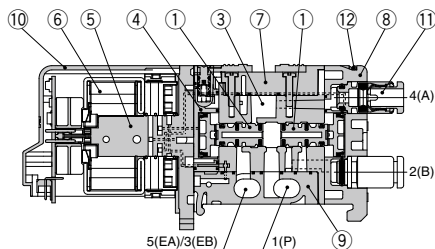

SJ2B60 [N.O. valve x 2]

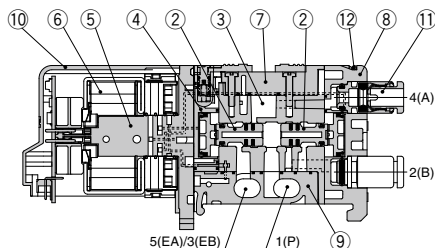

SJ2C60 [N.C. valve, N.O. valve x 1 (each)]

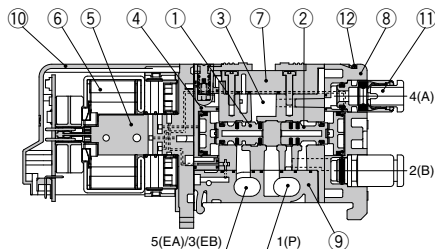

Component Parts

No.	Description	Material	Note
1	Spool valve assembly	Resin/HNBR	N.C. (Normally closed)
2	Spool valve assembly	Resin/HNBR	N.O. (Normally open)
3	Body	Zinc die-cast	—
4	Adapter plate	Resin	White
5	Pilot adapter	Resin	White
6	Pilot valve assembly	—	—
7	Body cover	Resin	White
8	Port block	Resin	White
9	Bottom cover assembly	Resin	White
10	Light cover	Resin	Light blue

Replacement Parts

No.	Description	Part no.
11	One-touch fitting	Refer to the One-touch fitting part no. on page 118.
12	Clip	SJ2000-CL-1 (10 pcs.)

SJ2A60K with back pressure check valve

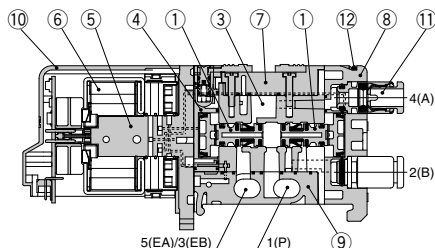

SJ3000: Cable Type

Symbol

2 position single

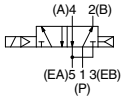

2 position single with back pressure check valve

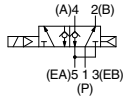

2 position double

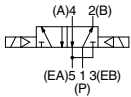

2 position double with back pressure check valve

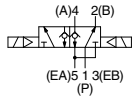

3 position closed center

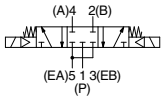

3 position exhaust center

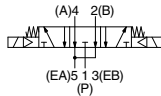

3 position pressure center

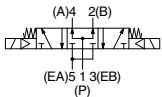

Component Parts

No.	Description	Material	Note
1	Spool valve assembly	Resin/HNBR (3 position solenoid valve: Aluminum/HNBR)	—
2	Body	Zinc die-cast	—
3	Adapter plate	Resin	White
4	Pilot adapter	Resin	White
5	Pilot valve assembly	—	—
6	Body cover	Resin	White
7	Port block	Resin	White
8	Bottom cover assembly	Resin	White
9	Light cover	Resin	Light blue

Replacement Parts

No.	Description	Part no.
10	One-touch fitting	Refer to the One-touch fitting part no. on page 118.
11	Clip	SJ3000-CL-1 (10 pcs.)

2 position single

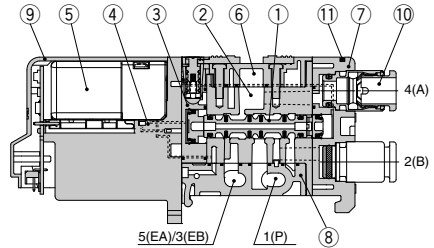

2 position double

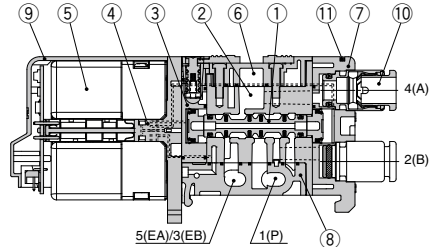

3 position closed center/exhaust center/pressure center

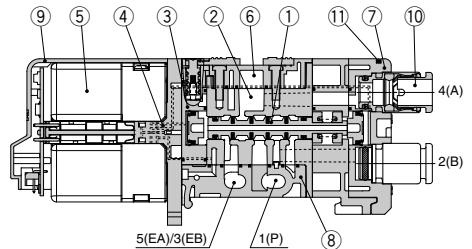

SJ3260K with back pressure check valve

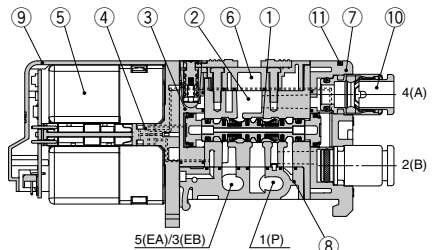

SJ

SY

SY

S0700

S0700

SJ2000/3000 Series Construction 5

SJ3000: Cable Type

Symbol

4 position dual 3 port valve
SJ3A60 [N.C. valve x 2]

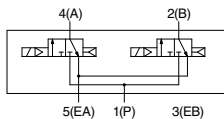

SJ3A60K with back pressure
check valve

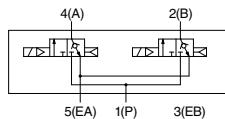

SJ3B60 [N.O. valve x 2]

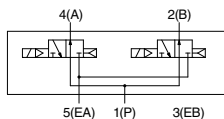

SJ3B60K with back pressure
check valve

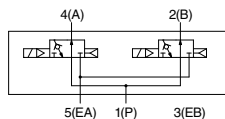

SJ3C60 [N.C., N.O. valve x 1
(each)]

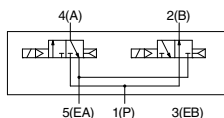

SJ3C60K with back pressure
check valve

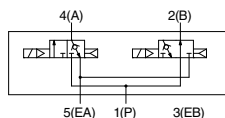

SJ3A60 [N.C. valve x 2]

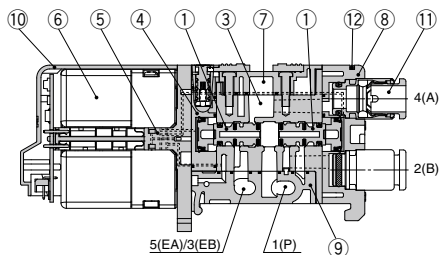

SJ3B60 [N.O. valve x 2]

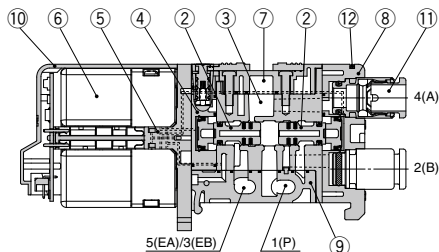

SJ3C60 [N.C. valve, N.O. valve x 1 (each)]

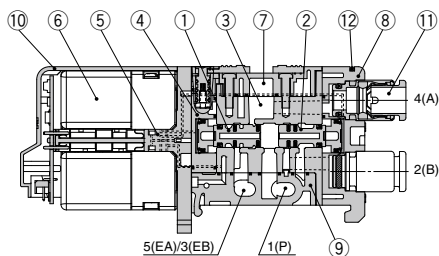

Component Parts

No.	Description	Material	Note
1	Spool valve assembly	Resin/HNBR	N.C. (Normally closed)
2	Spool valve assembly	Resin/HNBR	N.O. (Normally open)
3	Body	Zinc die-cast	—
4	Adapter plate	Resin	White
5	Pilot adapter	Resin	White
6	Pilot valve assembly	—	—
7	Body cover	Resin	White
8	Port block	Resin	White
9	Bottom cover assembly	Resin	White
10	Light cover	Resin	Light blue

Replacement Parts

No.	Description	Part no.
11	One-touch fitting	Refer to the One-touch fitting part no. on page 118.
12	Clip	SJ3000-CL-1 (10 pcs.)

SJ3A60K with back pressure check valve

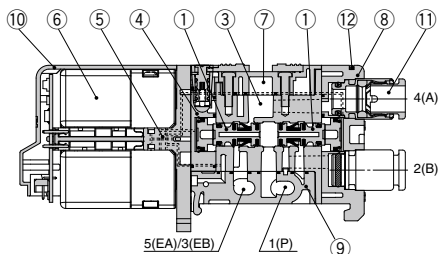

**Plug-in
Connector Type Manifold
Cable Type Manifold**

SJ2000/3000 Series

SJ

SY

SY

S0700

S0700

P.34

**Connector Type Manifold
D-sub Connector/Flat Ribbon Cable**

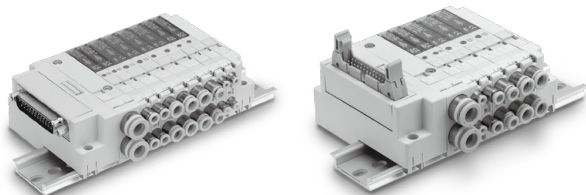

P.36

**Cable Type Manifold
D-sub Connector/Flat Ribbon Cable**

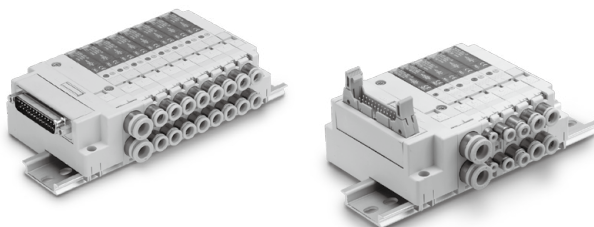

P.60

**Connector Type Manifold
EX180 Integrated-type (For
Output) Serial Transmission
System**

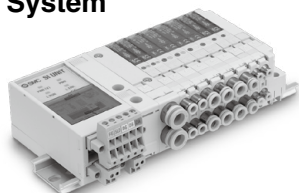

P.68

**Connector Type Manifold
EX510 Gateway-type
Serial Transmission System**

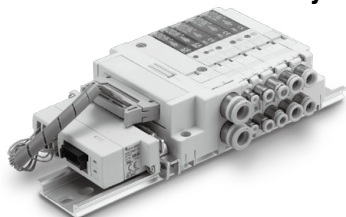

Plug-in Connector Type

D-sub Connector/Flat Ribbon Cable



SJ2000/3000 Series



An order cannot be placed with only the manifold part no. Be sure to order solenoid valves for mounting at the same time while referring to the ordering example.

How to Order

● Connector type manifold

SS5J3 - 60FD1 - 05U

Series

2	SJ2000
3	SJ3000 (SJ2000/3000 mixed)

Mixed mounting type

NII	Standard <small>Note 1)</small>
M	Mixed mounting <small>Note 2)</small>

Note 1) There is no need to enter anything when you operate either the SJ2000 or SJ3000 series alone.

Note 2) Enter "M" when the SJ2000 or SJ3000 series will be mounted on the same manifold base together.

Connector mounting position

Symbol	Mounting position
D	D side

Connector entry direction

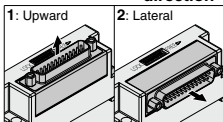

Connector type

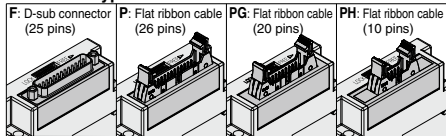

DIN rail length specified

NII	Standard length	
2	2 stations	Specify a longer rail than the
:	:	standard length.
24	24 stations	

* Specify the valve stations not exceeding the maximum stations.

SUP/EXH block fitting spec.

NII	Straight fitting	
	With external pilot spec. X, PE port	
L	Elbow fitting (Upward)	
	With external pilot spec. X, PE port	
B	Elbow fitting (Downward)	
	With external pilot spec. X, PE port	

* There is no need to enter anything when the SUP/EXH block mounting position "M" is selected.

Pilot spec.

NII	Internal pilot
S	Internal pilot/Built-in silencer
R	External pilot
RS	External pilot/Built-in silencer

* There is no need to enter anything when the SUP/EXH block mounting position "M" is selected.

* For built-in silencers, the 3/5(E) ports are plugged.

SUP/EXH block mounting position

U	U side (1 to 10 stations)
D	D side (1 to 10 stations)
B	Both sides (1 to 24 stations)
M*	Special specifications

* Specify the required specifications (including port sizes other than ø8) by means of the manifold specification sheet.

How to Order Manifold Assembly

Ordering example (SS5J3-60PD2-□)

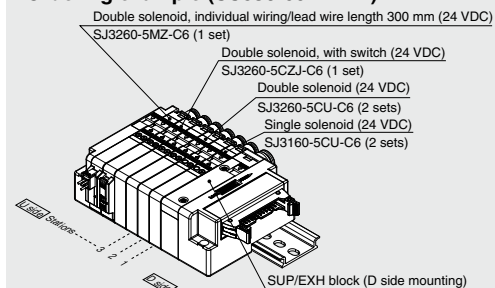

SS5J3-60PD2-06D ... 1 set (Manifold part no.)

- * SJ3160-5CU-C6 2 sets (Single solenoid part no.)
- * SJ3260-5CU-C6 2 sets (Double solenoid part no.)
- * SJ3260-5CZJ-C6 1 set (Double solenoid, with switch part no.)
- * SJ3260-5MZ-C6 1 set (Double solenoid, individual wiring/lead wire length 300 mm part no.)

→ The asterisk denotes the symbol for assembly. Prefix to the part no. of the solenoid valve, etc.

• The valve arrangement is numbered as the 1st station from D side.

• Indicate the valves to be attached below the manifold part number, in order starting from station 1 as shown in the drawing. In the case of complex arrangement, specify them in the manifold specification sheet.

Note) When ordering a manifold, specify the part nos. of valves to be mounted together.

(An order cannot be placed with only the manifold part no.)

Valve stations

F: D-sub connector

Symbol	Stations	Note
01	1 station	Up to 24 solenoids possible.
:	:	
24	24 stations	

P: Flat ribbon cable (26 pins)

Symbol	Stations	Note
01	1 station	Up to 24 solenoids possible.
:	:	
24	24 stations	

PG: Flat ribbon cable (20 pins)

Symbol	Stations	Note
01	1 station	Up to 18 solenoids possible.
:	:	
18	18 stations	

PH: Flat ribbon cable (10 pins)

Symbol	Stations	Note
01	1 station	Up to 8 solenoids possible.
:	:	
08	8 stations	

* The number of the blanking block assembly is also included. Since single and double wiring are available with the blanking block assembly, select a model compatible with the valve wiring spec. planned for the future. (Refer to page 89.)

How to Order Solenoid Valves

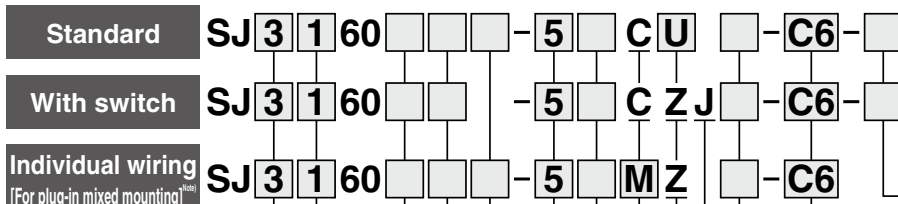

Note) Refer to pages 80 and 81 for the dedicated non plug-in individual wiring.

Series

2	SJ2000
3	SJ3000

Back pressure check valve

Nil	None
K	Built-in

* Back pressure check valve is not applicable for 3 position valve.

Rated voltage

5	24 VDC
6	12 VDC

Common specifications

Nil	Positive common
N	Negative common

* For the non-polar type, there is no need to select a symbol.

Single solenoid wiring spec.

Nil	Single wiring
D	Double wiring

* There is no need to enter anything for 2 position double, 3 position and 4 position solenoid valves. Select this when the unused numbers to wiring are set. Refer to page 24 for details.

Type of actuation

1	2 position single solenoid
2	2 position double solenoid
3	3 position closed center
4	3 position exhaust center
5	3 position pressure center
A	Dual 3 port valve: N.C./N.C.
B	Dual 3 port valve: N.O./N.O.
C	Dual 3 port valve: N.C./N.O.

* Refer to pages 25 through to 32 for the symbol.

Pilot spec.

Nil	Internal pilot
R	External pilot

* External pilot spec. is not applicable for 4 position dual 3 port valves.

Coil spec.

Nil	Standard
T	With power saving circuit (Continuous duty type)

* Be sure to select "with power saving circuit" when the solenoid valve will be energized continuously for long period.

Light/surge voltage suppressor

U	With light/surge voltage suppressor (Non-polar type)
Z	With light/surge voltage suppressor (Polar type)

* When the types with power saving circuit, with switches, and individual wiring are used, the non-polar type cannot be selected.

A, B port size

Straight

(Metric size)

- C2:** ø2 One-touch fitting
- C4:** ø4 One-touch fitting
- C6:** ø6 One-touch fitting (SJ3000 only)

(Inch size)

- N1:** ø1/8" One-touch fitting
- N3:** ø5/32" One-touch fitting
- N7:** ø1/4" One-touch fitting (SJ3000 only)

- M3:** M3 x 0.5 (SJ2000 only)
- M5:** M5 x 0.8 (SJ3000 only)



Connector entry

C: Dedicated for centralized wiring

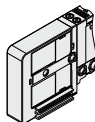

M: Individual wiring, With lead wire
Length 300 mm

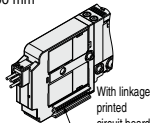

MN: Individual wiring, Without lead wire
(With connector, socket)

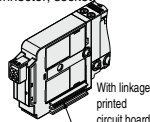

MO: Individual wiring, Without connector

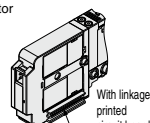

* Connector entries with the symbol "M□" can not use the switch signal from the common wiring on the manifold. For details, refer to "Connector Wiring Diagram" on page 24.
* When ordering a connector assembly separately, refer to pages 120 and 121.

With switch

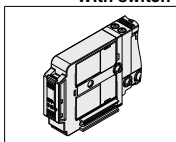

Manual override

Nil: Non-locking push type

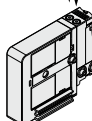

D: Push-turn locking slotted type

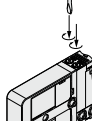

F: Slide locking type

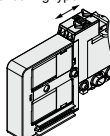

Elbow fitting assembly (Upward entry)

(Metric size)

- L2:** ø2 elbow fitting assembly
- L4:** ø4 elbow fitting assembly
- L6:** ø6 elbow fitting assembly (SJ3000 only)

(Inch size)

- LN1:** ø1/8" elbow fitting assembly
- LN3:** ø5/32" elbow fitting assembly
- LN7:** ø1/4" elbow fitting assembly (SJ3000 only)

Elbow fitting assembly (Downward entry)

(Metric size)

- B2:** ø2 elbow fitting assembly
- B4:** ø4 elbow fitting assembly
- B6:** ø6 elbow fitting assembly (SJ3000 only)

(Inch size)

- BN1:** ø1/8" elbow fitting assembly
- BN3:** ø5/32" elbow fitting assembly
- BN7:** ø1/4" elbow fitting assembly (SJ3000 only)

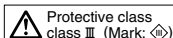

Plug-in Cable Type

D-sub Connector/Flat Ribbon Cable



SJ2000/3000 Series



An order cannot be placed with only the manifold part no. Be sure to order solenoid valves for mounting at the same time while referring to the ordering example.

How to Order

● Cable type manifold

SS5J3-60LFD1-05U

Series

2	SJ2000
3	SJ3000

Cable type

Connector mounting position

Symbol	Mounting position
D	D side

Connector entry direction

1: Upward 2: Lateral

Connector type

F: D-sub connector (25 pins) P: Flat ribbon cable (26 pins)

PG: Flat ribbon cable (20 pins) PH: Flat ribbon cable (10 pins)

Manifold wiring spec.

Nil	All double wiring <small>Note 1)</small>
S	All single wiring <small>Note 2)</small>

DIN rail length specified

Nil	Standard length
3	3 stations Specify a longer rail than the standard length.
⋮	⋮
20	20 stations

SUP/EXH block fitting spec.

Nil	Straight fitting
L <th>Elbow fitting (Upward)</th>	Elbow fitting (Upward)
B <th>Elbow fitting (Downward)</th>	Elbow fitting (Downward)

* Specify the valve stations not exceeding the maximum stations.

* There is no need to enter anything when the SUP/EXH block mounting position "M" is selected.

How to Order Manifold Assembly

Ordering example (SS5J3-60LPD2)

Double solenoid (24 VDC)
SJ3260-5FZ-C6 (4 sets)

Single solenoid (24 VDC)
SJ3160-5FZ-C6 (2 sets)

SS5J3-60LPD2-06D... 1 set (Manifold part no.)

*** SJ3160-5FZ-C6... 2 sets (Single solenoid part no.)**

*** SJ3260-5FZ-C6... 4 sets (Double solenoid part no.)**

The asterisk denotes the symbol for assembly. Prefix to the part no. of the solenoid valve, etc.

* The valve arrangement is numbered as the 1st station from D side.

* Indicate the valves to be attached below the manifold part number, in order starting from station 1 as shown in the drawing. In the case of complex arrangement, specify them in the manifold specification sheet.

Note) When ordering a manifold, specify the part nos. of valves to be mounted together. (An order cannot be placed with only the manifold part no.)

SUP/EXH block mounting position

U	U side (2 to 10 stations)
D	D side (2 to 10 stations)
B	Both sides (2 to 20 stations)
M*	Special specifications

* Specify the required specifications (including port sizes other than ø8) by means of the manifold specification sheet.

Pilot spec.

Nil	Internal pilot
S	Internal pilot/ Built-in silencer
R	External pilot
RS	External pilot/ Built-in silencer

* There is no need to enter anything when the SUP/EXH block mounting position "M" is selected.

Valve stations

F: D-sub connector (25 pins)	P: Flat ribbon cable (26 pins)	PG: Flat ribbon cable (20 pins)						
Symbol	Stations	Note	Symbol	Stations	Note	Symbol	Stations	Note
02	2 stations	All double wiring	02	2 stations	All double wiring	02	2 stations	All double wiring
10	10 stations	All double wiring	10	10 stations	All double wiring	09	9 stations	All double wiring
02	2 stations	All single wiring	02	2 stations	All single wiring	02	2 stations	All single wiring
20	20 stations	All single wiring	20	20 stations	All single wiring	18	18 stations	All single wiring

PH: Flat ribbon cable (10 pins)

Symbol	Stations	Note
02	2 stations	All double wiring
04	4 stations	All double wiring
02	2 stations	All single wiring
08	8 stations	All single wiring

* The number of the blanking block assembly is also included.

* The cable type is applicable to 2 or more stations.

How to Order Solenoid Valves

SJ 3 1 60 - 5 F Z - C6

Series

2	SJ2000
3	SJ3000

Type of actuation

1	2 position single solenoid
2	2 position double solenoid
3	3 position closed center
4	3 position exhaust center
5	3 position pressure center
A	Dual 3 port valve: N.C./N.C.
B	Dual 3 port valve: N.O./N.O.
C	Dual 3 port valve: N.C./N.O.

* Refer to pages 25 through to 32 for the symbol.

Pilot spec.

Nil	Internal pilot
R	External pilot

* External pilot spec. is not applicable for 4 position dual 3 port valves.

Back pressure check valve

Nil	None
K	Built-in

* Back pressure check valve is not applicable for 3 position valve.

Coil spec.

Nil	Standard
T	With power saving circuit (Continuous duty type)

* Be sure to select "with power saving circuit" when the solenoid valve will be energized continuously for long period.

Rated voltage

5	24 VDC
6	12 VDC

Common specifications

Nil	Positive common
N	Negative common

Connector entry

F: Dedicated for centralized wiring, cable type

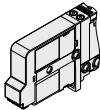

Light/surge voltage suppressor

Z | With light/surge voltage suppressor

Manual override

Nil: Non-locking push type

D: Push-turn locking slotted type

F: Slide locking type

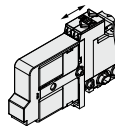
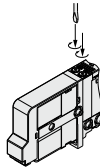
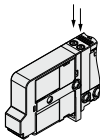

A, B port size

Straight

(Metric size)

C2: ø2 One-touch fitting

C4: ø4 One-touch fitting

C6: ø6 One-touch fitting (SJ3000 only)

(Inch size)

N1: ø1/8" One-touch fitting

N3: ø5/32" One-touch fitting

N7: ø1/4" One-touch fitting (SJ3000 only)



M3: M3 x 0.5 (SJ2000 only)

M5: M5 x 0.8 (SJ3000 only)



Elbow fitting (Upward entry)
 (Metric size)

L2: ø2 elbow fitting

L4: ø4 elbow fitting

L6: ø6 elbow fitting (SJ3000 only)

(Inch size)

LN1: ø1/8" elbow fitting

LN3: ø5/32" elbow fitting

LN7: ø1/4" elbow fitting (SJ3000 only)



Elbow fitting (Downward entry)
 (Metric size)

B2: ø2 elbow fitting

B4: ø4 elbow fitting

B6: ø6 elbow fitting (SJ3000 only)

(Inch size)

BN1: ø1/8" elbow fitting

BN3: ø5/32" elbow fitting

BN7: ø1/4" elbow fitting (SJ3000 only)

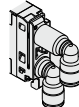

SJ2000/3000 Series

Manifold Electrical Wiring/Connector Type (Non-polar Type)

Type 60F: D-sub connector (25 pins)

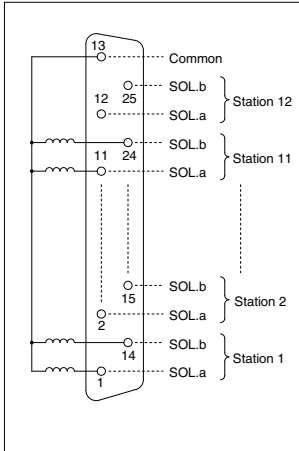

Note) This circuits are for the specifications with up to 12 stations of 2 position double, 3 position and 4 position dual 3 port valve. There should be wired in order 1→14→2→15 without skipping or leaving any connectors remaining.

Type 60P: Flat ribbon cable (26 pins)

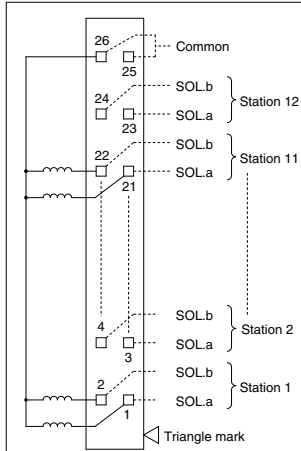

Note) This circuits are for the specifications with up to 12 stations of 2 position double, 3 position and 4 position dual 3 port valve. There should be wired in order 1→2→3→4 without skipping or leaving any connectors remaining.

Type 60PG: Flat ribbon cable (20 pins)

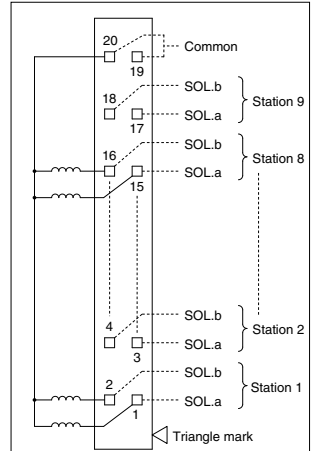

Note) This circuits are for the specifications with up to 9 stations of 2 position double, 3 position and 4 position dual 3 port valve. There should be wired in order 1→2→3→4 without skipping or leaving any connectors remaining.

Type 60PH: Flat ribbon cable (10 pins)

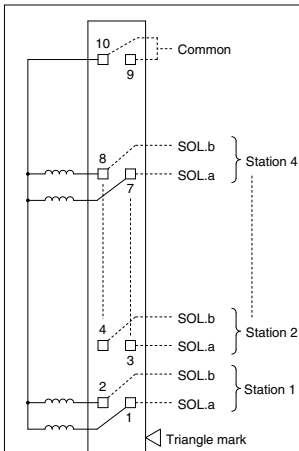

Note) This circuits are for the specifications with up to 4 stations of 2 position double, 3 position and 4 position dual 3 port valve. There should be wired in order 1→2→3→4 without skipping or leaving any connectors remaining.

⚠ Caution

When the non-polar U type valves are used, either positive common or negative common wiring of the manifold is possible. However, when the Z type valves are used, select the positive common or negative common according to the wiring specifications.

Manifold Electrical Wiring/Cable Type

Type 60LF: D-sub connector (25 pins)

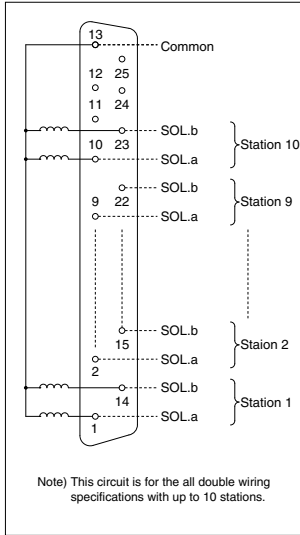

Type 60LP: Flat ribbon cable (26 pins)

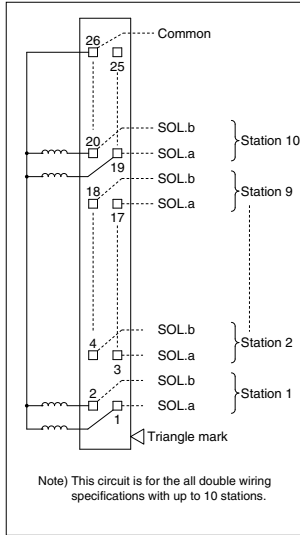

Type 60LPG: Flat ribbon cable (20 pins)

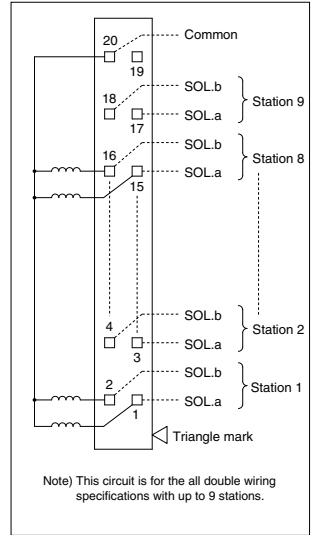

SJ
SY
SY
S0700
S0700

Type 60LPH: Flat ribbon cable (10 pins)

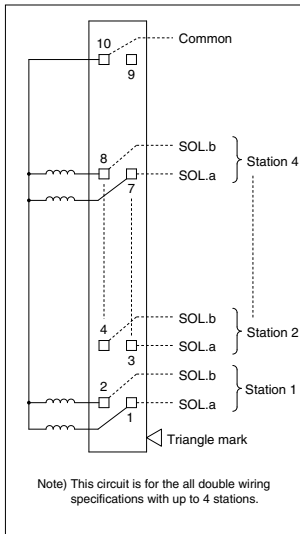

⚠ Caution

When the non-polar U type valves are used, either positive common or negative common wiring of the manifold is possible. However, when the Z type valves are used, select the positive common or negative common according to the wiring specifications.

SJ2000/3000 Series

Dimensions: SJ2000 Series for D-sub Connector

SS5J2-60FD₂-[Stations]U(S, R, RS)

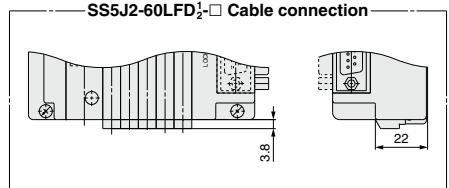
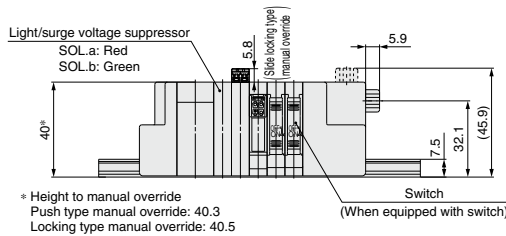
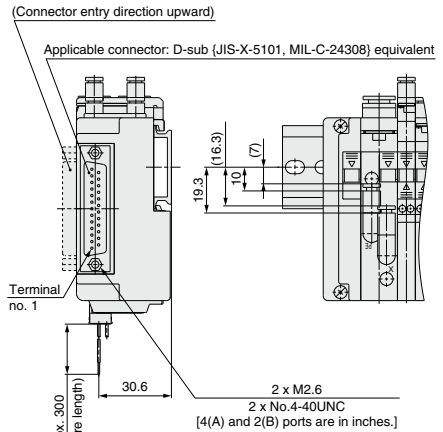
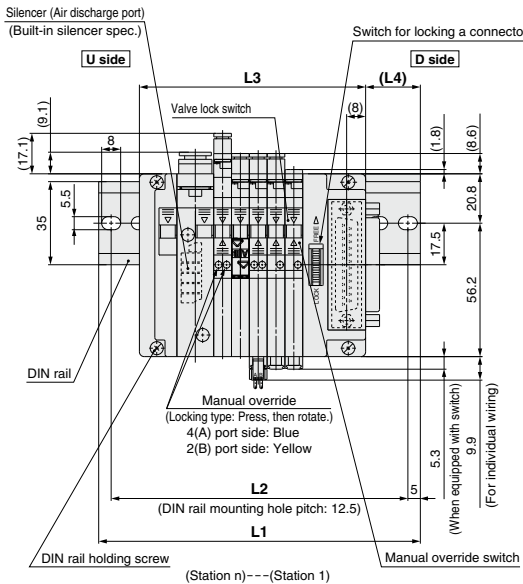
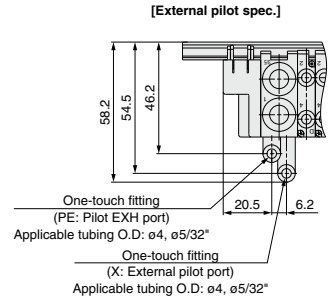
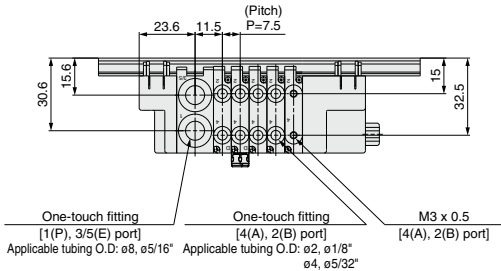

L: Dimensions

L	n	1	2	3	4	5	6	7	8	9	10
L1		98	110.5	110.5	123	135.5	135.5	148	148	160.5	173
L2		87.5	100	100	112.5	125	125	137.5	137.5	150	162.5
L3		65.3	72.8	80.3	87.8	95.3	102.8	110.3	117.8	125.3	132.8
L4		19.5	22	18	20.5	23	19.5	22	18	20.5	23

Note) For manifold dimensions including elbow fitting, refer to page 50.

Dimensions: SJ2000 Series for D-sub Connector

SS5J2-60FD₂ - Stations B(S, R, RS)

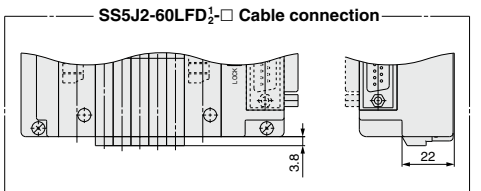
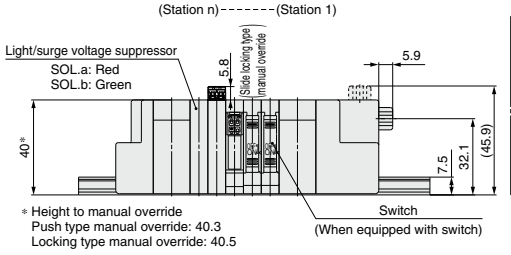
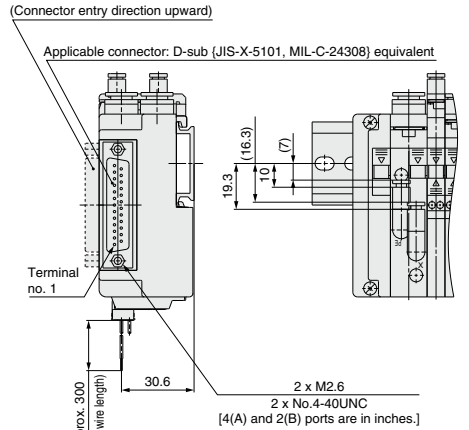
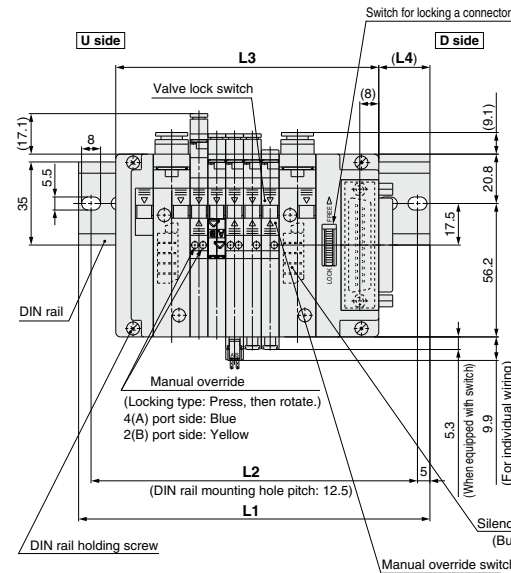
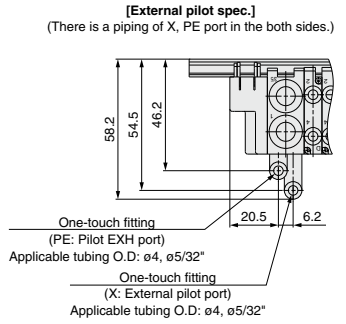
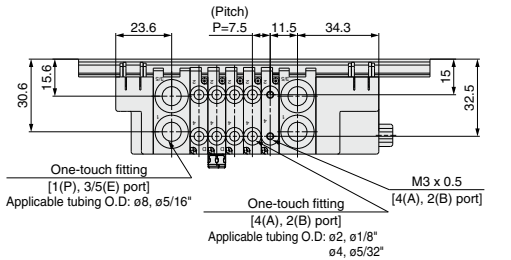

* Height to manual override
Push type manual override: 40.3
Locking type manual override: 40.5

Note) For manifold dimensions including elbow fitting, refer to page 50.

L: Dimensions		n: Stations																							
L	n	1	2	3	4	5	6	7	8	9	10	11	12	13	14	15	16	17	18	19	20	21	22	23	24
L1		110.5	123	135.5	135.5	148	148	160.5	173	173	185.5	185.5	198	210.5	210.5	223	223	235.5	248	248	260.5	260.5	273	285.5	285.5
L2		100	112.5	125	125	137.5	137.5	150	162.5	162.5	175	175	187.5	200	200	212.5	212.5	225	237.5	237.5	250	250	262.5	275	275
L3		80.8	88.3	95.8	103.3	110.8	118.3	125.8	133.3	140.8	148.3	155.8	163.3	170.8	178.3	185.8	193.3	200.8	208.3	215.8	223.3	230.8	238.3	245.8	253.3
L4		18	20.5	23	19	21.5	18	20.5	23	19	21.5	18	20.5	23	19	21.5	18	20.5	23	19	21.5	18	20.5	23	19

SJ

SY

SY

S0700

S0700

SJ2000/3000 Series

Dimensions: SJ3000 Series for D-sub Connector

SS5J3-60FD₂-[Stations]U(S, R, RS)

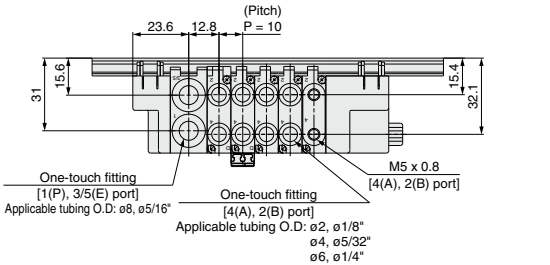

[External pilot spec.]

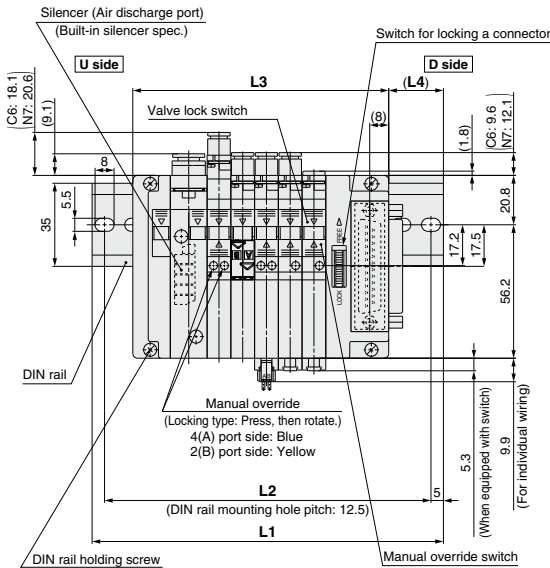
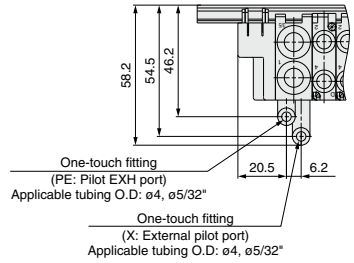

(Connector entry direction upward)

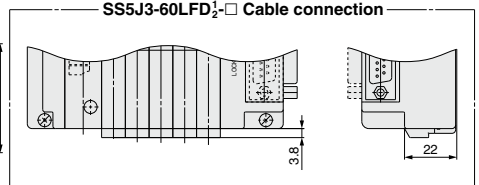
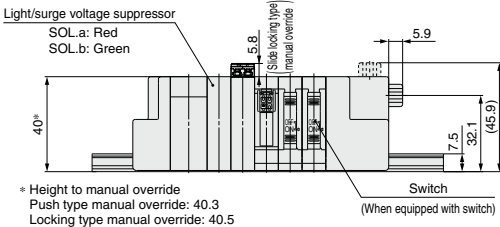
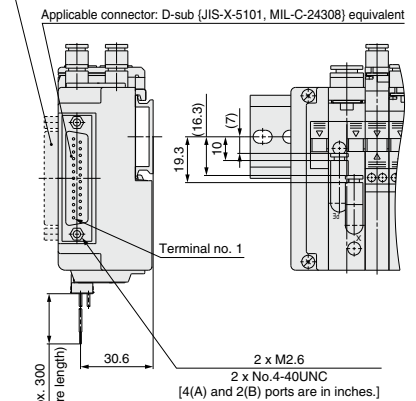

Note) For manifold dimensions including elbow fitting, refer to page 51.

L: Dimensions

	n: Stations									
n	1	2	3	4	5	6	7	8	9	10
L1	98	110.5	123	135.5	148	148	160.5	173	185.5	198
L2	87.5	100	112.5	125	137.5	137.5	150	162.5	175	187.5
L3	67.8	77.8	87.8	97.8	107.8	117.8	127.8	137.8	147.8	157.8
L4	18	19	20.5	21.5	22.5	17.5	18.5	20	21	22

Dimensions: SJ3000 Series for D-sub Connector

SS5J3-60FD₂-[Stations]B(S, R, RS)

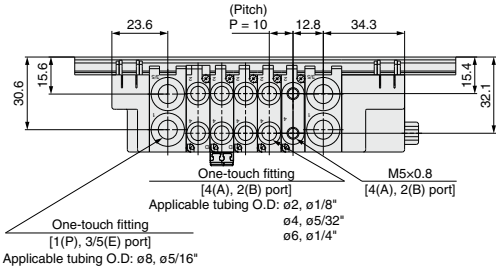

[External pilot spec.]
(There is a piping of X, PE port in the both sides.)

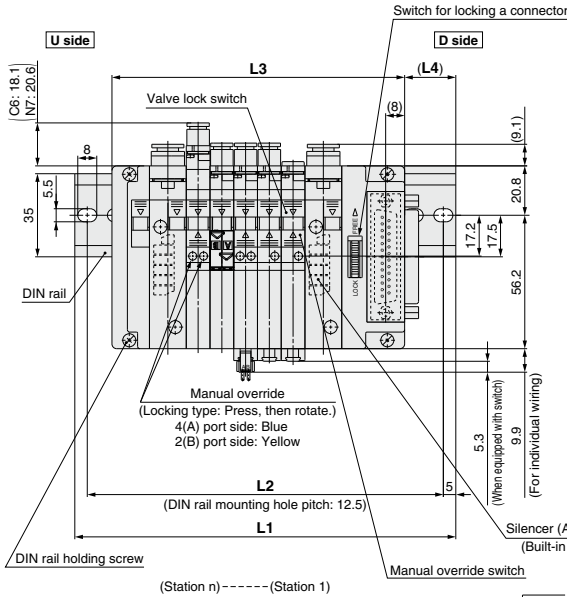
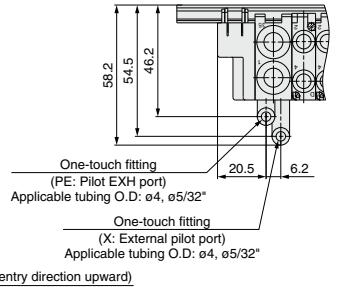

(Connector entry direction upward)

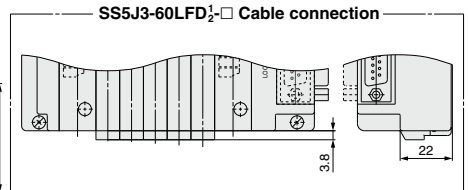
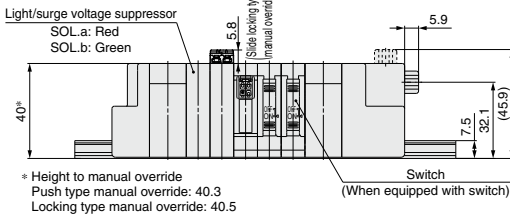
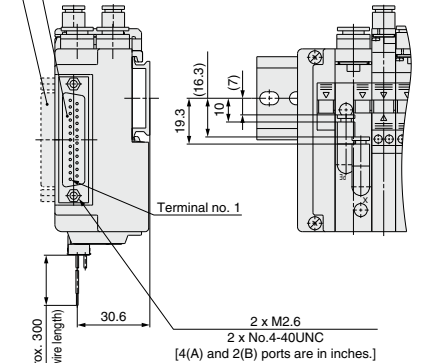

Note) For manifold dimensions including elbow fitting, refer to page 51.

L: Dimensions

L	n	1	2	3	4	5	6	7	8	9	10	11	12	13	14	15	16	17	18	19	20	21	22	23	24
L1		123	123	135.5	148	160.5	173	185.5	185.5	198	210.5	223	235.5	235.5	248	260.5	273	285.5	298	298	310.5	323	335.5	348	348
L2		112.5	112.5	125	137.5	150	162.5	175	175	187.5	200	212.5	225	225	237.5	250	262.5	275	287.5	287.5	300	312.5	325	337.5	337.5
L3		83.3	93.3	103.3	113.3	123.3	133.3	143.3	153.3	163.3	173.3	183.3	193.3	203.3	213.3	223.3	233.3	243.3	253.3	263.3	273.3	283.3	293.3	303.3	313.3
L4		22.5	17.5	19	20	21	22	23.5	18.5	19.5	20.5	21.5	23	18	19	20	21	22.5	23.5	18.5	19.5	20.5	22	23	18

n: Stations

SJ2000/3000 Series

Dimensions: SJ2000/3000 Mixed Manifold

SS5J3-M60FD₂-[Stations] U(S, R, RS)

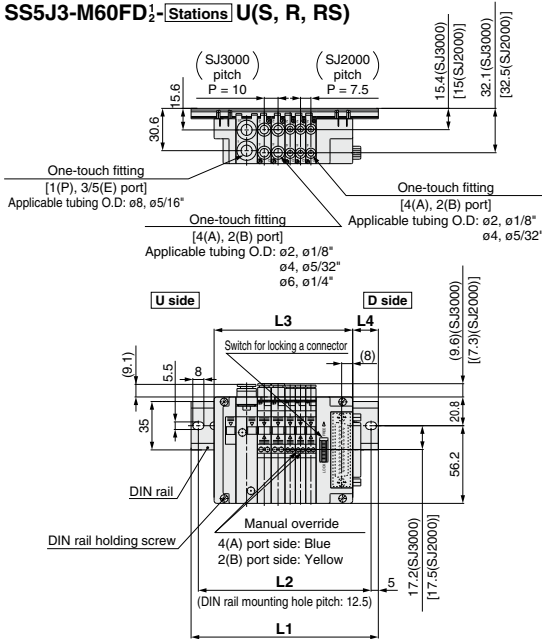

L dimension: Formula, L1 to L4
 $L3 = 7.5 \times n1 + 10 \times n2 + 57.8$
 $M = (L3 + 9.9) / 12.5 + 1$
 Remove all numbers after the decimal.
 $L1 = M \times 12.5 + 23$
 $L2 = L1 - 10.5$
 $L4 = (L1 - L3) / 2 + 1$

n1: Quantity of SJ2000
 n2: Quantity of SJ3000

* The dimensions of L1 to L4 for SS5J3-M60FD_{1/2}-[Stations] D are the same as those of SS5J3-M60FD_{1/2}-[Stations] U.

Applicable connector: D-sub (JIS-X-5101, MIL-C-24308) equivalent

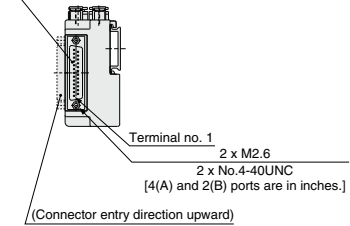

SS5J3-M60FD₂-[Stations] B(S, R, RS)

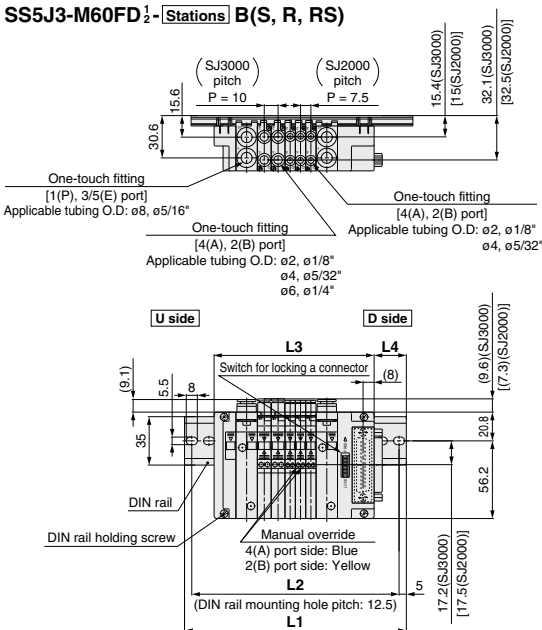

L dimension: Formula, L1 to L4
 $L3 = 7.5 \times n1 + 10 \times n2 + 73.3$
 $M = (L3 + 9.9) / 12.5 + 1$
 Remove all numbers after the decimal.
 $L1 = M \times 12.5 + 23$
 $L2 = L1 - 10.5$
 $L4 = (L1 - L3) / 2 + 1$

n1: Quantity of SJ2000
 n2: Quantity of SJ3000

Applicable connector: D-sub (JIS-X-5101, MIL-C-24308) equivalent

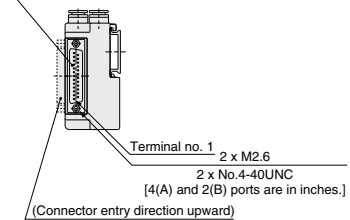

Dimensions: SJ2000 Series for Flat Ribbon Cable

SS5J2-60PD₂- Stations U(S, R, RS)

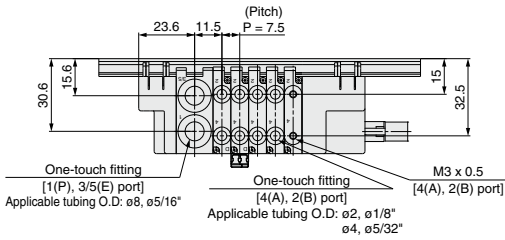

[External pilot spec.]

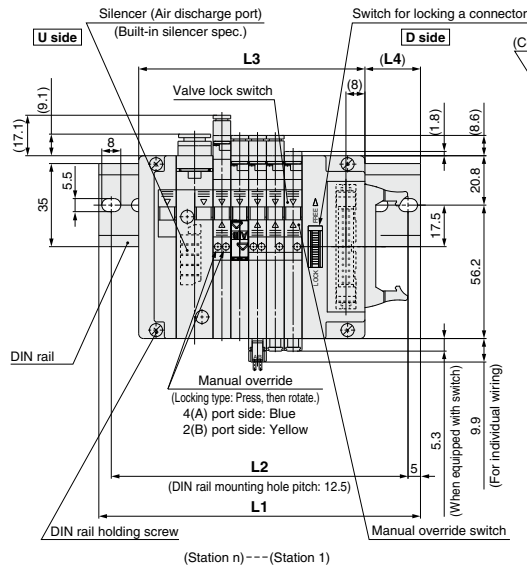
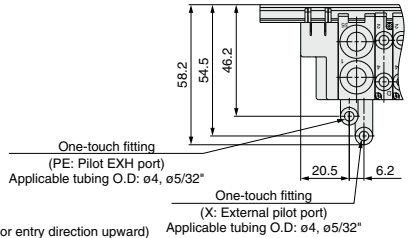

(Connector entry direction upward)
Applicable connector: 26 pin MIL type with strain relief (MIL-C-83503 compliant)

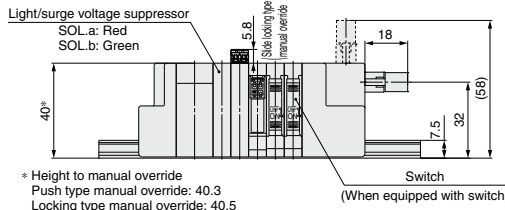
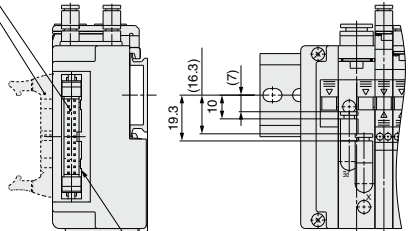

Applicable connector: 20 pin MIL type with strain relief (MIL-C-83503 compliant)

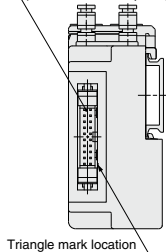

Applicable connector: 10 pin MIL type with strain relief (MIL-C-83503 compliant)

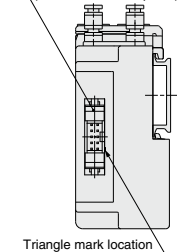

In case of 60PG (20 pins)

In case of 60PH (10 pins)

Note 1) Type 60PG and 60PH differ only in their connectors, and the L1 through L4 dimensions are the same as type 60P.
Note 2) For manifold dimensions including elbow fitting, refer to page 50.

L: Dimensions

L	n	n: Stations									
		1	2	3	4	5	6	7	8	9	10
L1	98	110.5	110.5	123	135.5	135.5	148	148	160.5	173	
L2	87.5	100	100	112.5	125	125	137.5	137.5	150	162.5	
L3	65.3	72.8	80.3	87.8	95.3	102.8	110.3	117.8	125.3	132.8	
L4	19.5	22	18.5	21	23.5	19.5	22	18.5	21	23.5	

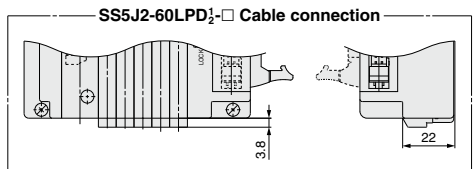

SJ2000/3000 Series

Dimensions: SJ2000 Series for Flat Ribbon Cable

SS5J2-60PD₂ - Stations B(S, R, RS)

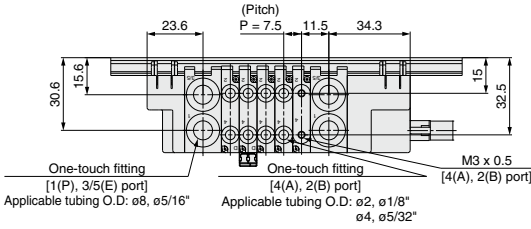

[External pilot spec.]
(There is a piping of X, PE port in the both sides.)

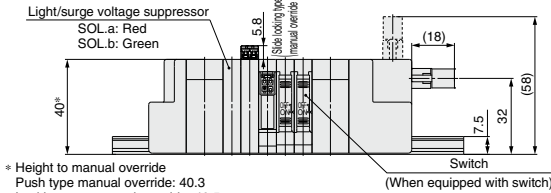
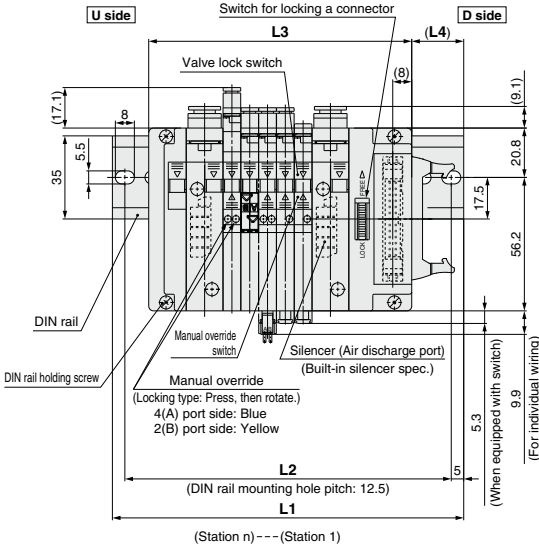
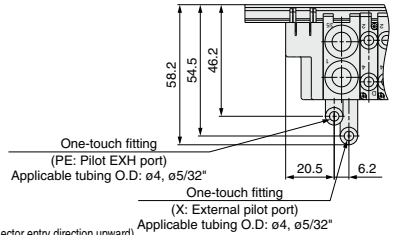

SS5J2-60LPD₂ - Cable connection

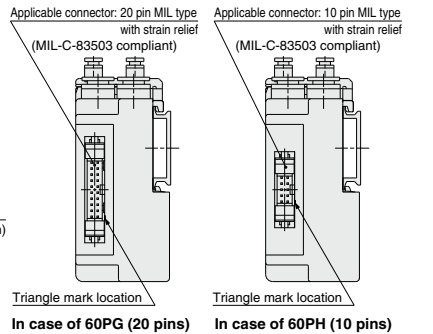
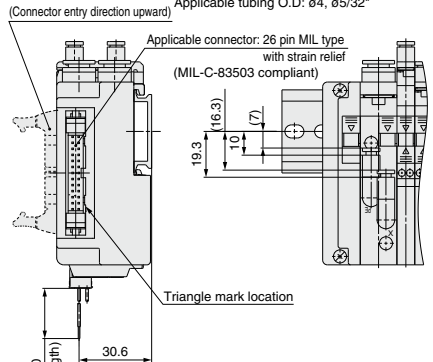
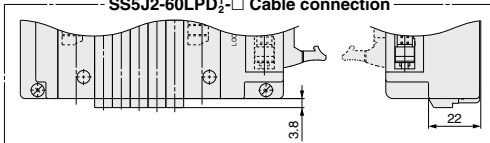

Note 1) Type 60PG and 60PH differ only in their connectors, and the L1 through L4 dimensions are the same as type 60P.
Note 2) For manifold dimensions including elbow fitting, refer to page 50.

L: Dimensions

L \ n	1	2	3	4	5	6	7	8	9	10	11	12	13	14	15	16	17	18	19	20	21	22	23	24
L1	110.5	123	135.5	135.5	148	148	160.5	173	173	185.5	185.5	198	210.5	210.5	223	223	235.5	248	248	260.5	260.5	273	285.5	285.5
L2	106	112.5	125	125	137.5	137.5	150	162.5	162.5	175	175	187.5	200	200	212.5	212.5	225	237.5	237.5	250	250	262.5	275	275
L3	80.8	88.3	95.8	103.3	110.8	118.3	125.8	133.3	140.8	148.3	155.8	163.3	170.8	178.3	185.8	193.3	200.8	208.3	215.8	223.3	230.8	238.3	245.8	253.3
L4	18	20.5	23	19.5	22	18	20.5	23	19.5	22	18	20.5	23	19.5	22	18	20.5	23	19.5	22	18	20.5	23	19.5

n: Stations

Dimensions: SJ3000 Series for Flat Ribbon Cable

SS5J3-60PD₂-Stations U(S, R, RS)

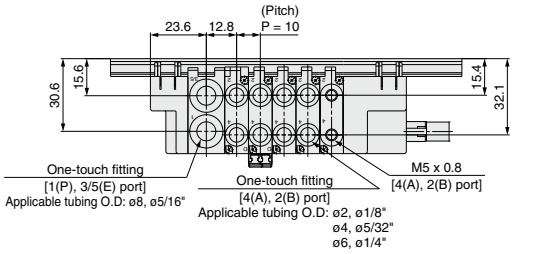

[External pilot spec.]

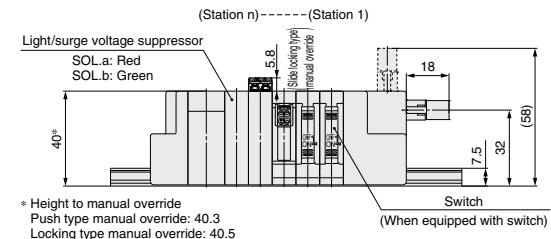
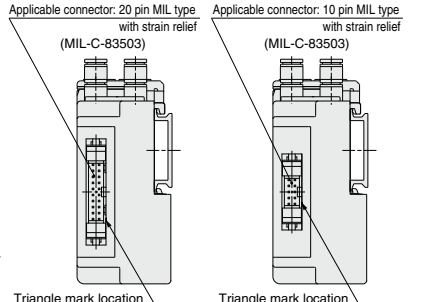
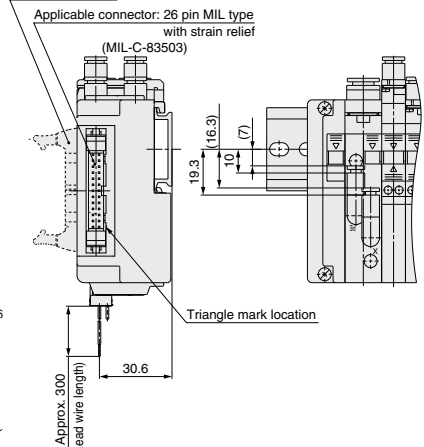
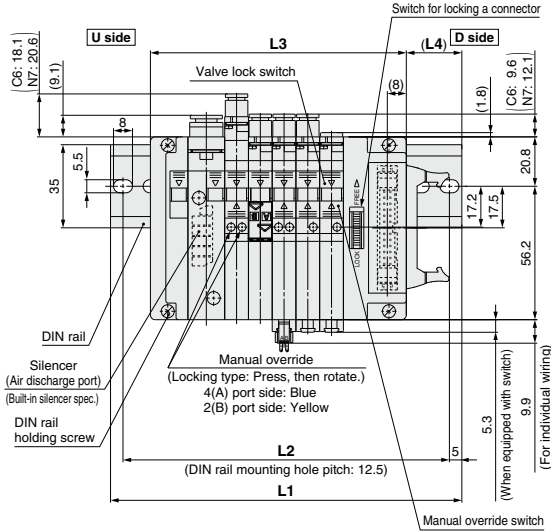
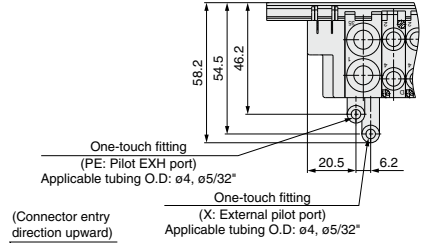

Note 1) Type 60PG and 60PH differ only in their connectors, and the L1 through L4 dimensions are the same as type 60P.
Note 2) For manifold dimensions including elbow fitting, refer to page 51.

In case of 60PG (20 pins) In case of 60PH (10 pins)

L: Dimensions

L	n	n: Stations									
		1	2	3	4	5	6	7	8	9	10
L1	98	110.5	123	135.5	148	160.5	160.5	173	185.5	198	
L2	87.5	100	112.5	125	137.5	150	150	162.5	175	187.5	
L3	67.8	77.8	87.8	97.8	107.8	117.8	127.8	137.8	147.8	157.8	
L4	18.5	19.5	20.5	22	23	24	19	20	21.5	22.5	

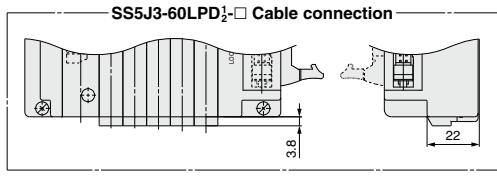

SJ
SY
SY
S0700
S0700

SJ2000/3000 Series

Dimensions: SJ3000 Series for Flat Ribbon Cable

SS5J3-60PD₂ - Stations B(S, R, RS)

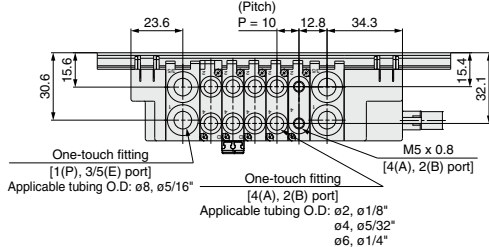

[External pilot spec.]
(There is a piping of X, PE port in the both sides.)

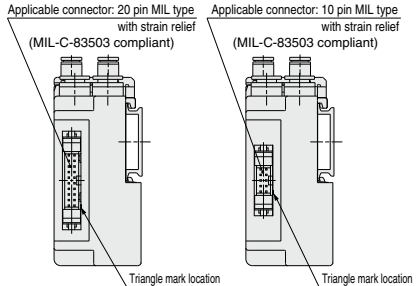
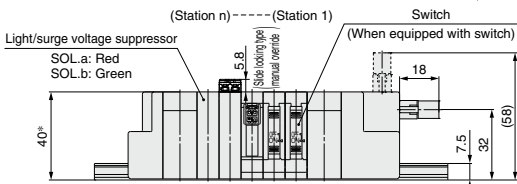
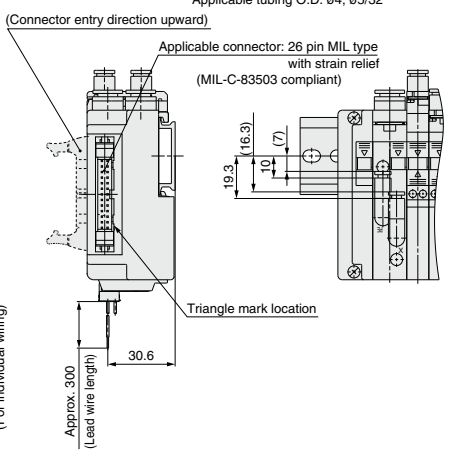
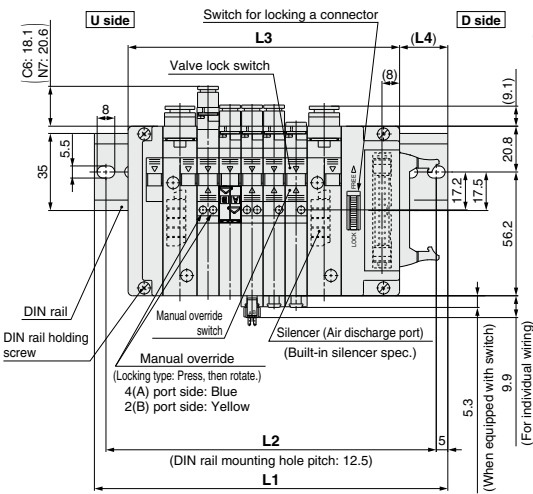
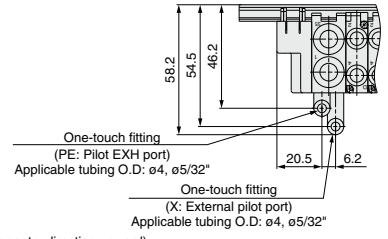

* Height to manual override
Push type manual override: 40.3
Locking type manual override: 40.5

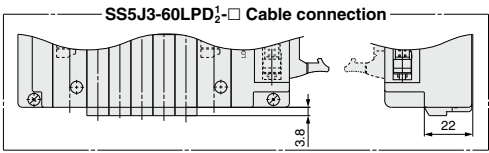

In case of 60PG (20 pins) In case of 60PH (10 pins)

Note 1) Type 60PG and 60PH differ only in their connectors, and the L1 through L4 dimensions are the same as type 60P.
Note 2) For manifold dimensions including elbow fitting, refer to page 51.

L: Dimensions

L	n	1	2	3	4	5	6	7	8	9	10	11	12	13	14	15	16	17	18	19	20	21	22	23	24
L1		123	135.5	135.5	148	160.5	173	185.5	185.5	198	210.5	223	235.5	248	248	260.5	273	285.5	298	298	310.5	323	335.5	348	348
L2		112.5	125	125	137.5	150	162.5	175	175	187.5	200	212.5	225	237.5	237.5	250	262.5	275	287.5	287.5	300	312.5	325	337.5	337.5
L3		83.3	93.3	103.3	113.3	123.3	133.3	143.3	153.3	163.3	173.3	183.3	193.3	203.3	213.3	223.3	233.3	243.3	253.3	263.3	273.3	283.3	293.3	303.3	313.3
L4		23	24	19	20.5	21.5	22.5	23.5	18.5	20	21	22	23	24.5	19.5	20.5	21.5	22.5	24	19	20	21	22	23.5	18.5

n: Stations

Dimensions: SJ2000/3000 Mixed Manifold

SS5J3-M60PD₂-[Stations]U(S, R, RS)

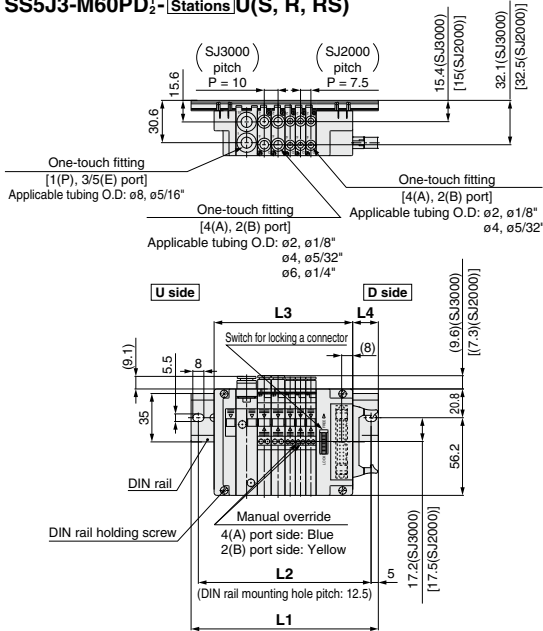

L dimension: Formula, L1 to L4
 $L3 = 7.5 \times n1 + 10 \times n2 + 57.8$
 $M = (L3 + 10.6)/12.5 + 1$
 Remove all numbers after the decimal.
 $L1 = M \times 12.5 + 23$
 $L2 = L1 - 10.5$
 $L4 = (L1 - L3)/2 + 1.3$

n1: Quantity of SJ2000
 n2: Quantity of SJ3000

* The dimensions of L1 to L4 for **SS5J3-M60PD1/2-[Stations]D** are the same as those of **SS5J3-M60PD1/2-[Stations]U**.

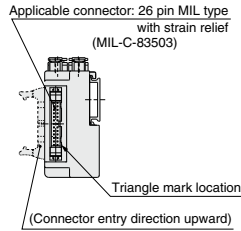

SS5J3-M60PD₂-[Stations]B(S, R, RS)

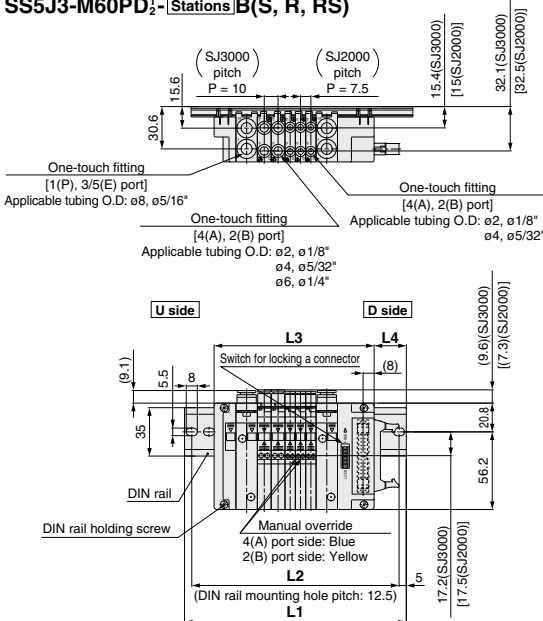

L dimension: Formula, L1 to L4
 $L3 = 7.5 \times n1 + 10 \times n2 + 73.3$
 $M = (L3 + 10.6)/12.5 + 1$
 Remove all numbers after the decimal.
 $L1 = M \times 12.5 + 23$
 $L2 = L1 - 10.5$
 $L4 = (L1 - L3)/2 + 1.3$

n1: Quantity of SJ2000
 n2: Quantity of SJ3000

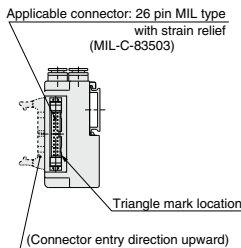

SJ2000/3000 Series

Dimensions: SJ2000 Series with Elbow Fittings

SS5J2-60FD₂-[Stations]U₁

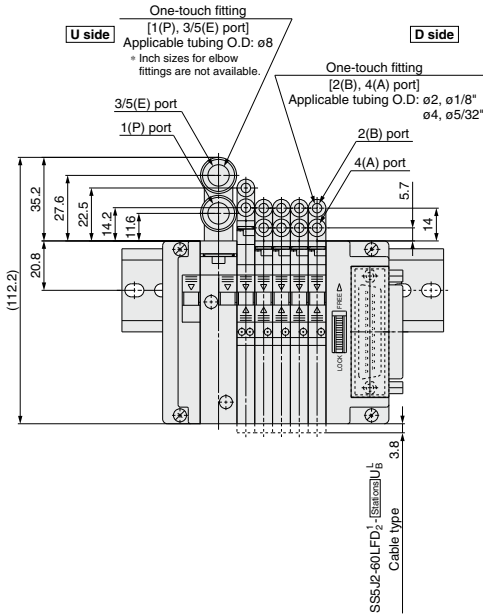
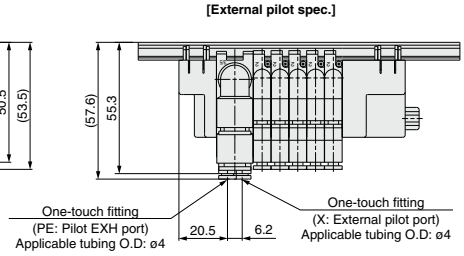
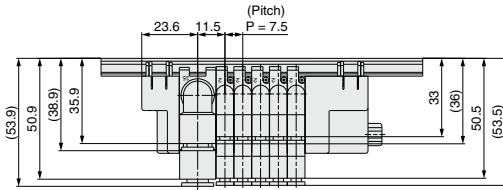

[SUP/EXH block (External pilot spec.)]

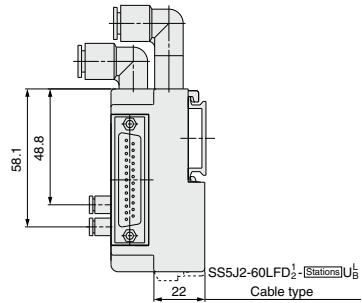

Downward (B type)

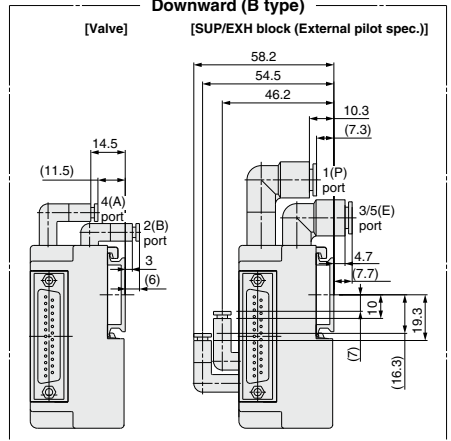

(Station n) --- (Station 1)

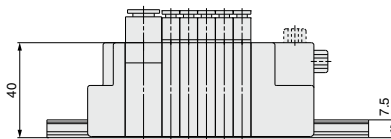

Dimensions: SJ3000 Series with Elbow Fittings

SS5J3-60FD₂-(Stations) U₆

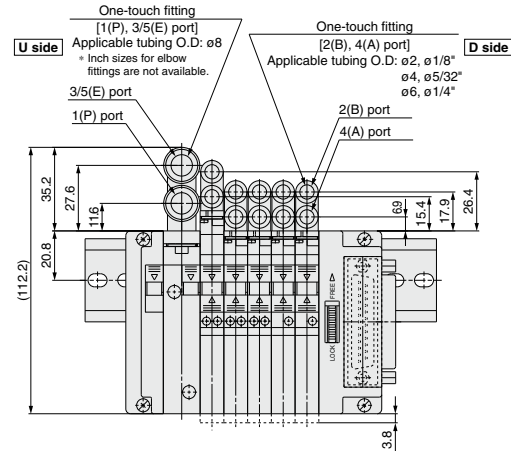
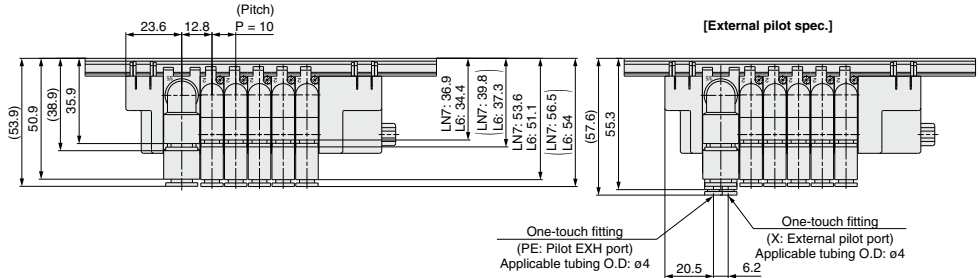

[SUP/EXH block (External pilot spec.)]

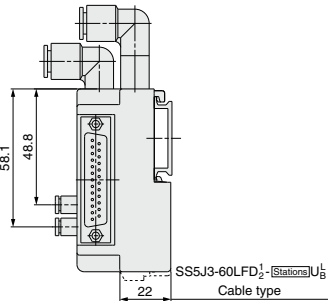

Downward (B type)

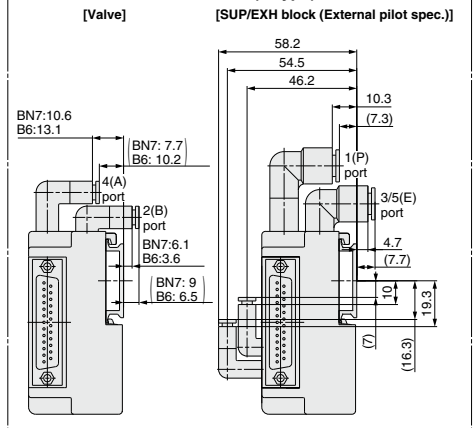

SJ
SY
SY
S0700
S0700

Plug-in Connector Type

EX180 Integrated-type (For Output) Serial Transmission System



Type **60S**

SJ2000/3000 Series

An order cannot be placed with only the manifold part no. Be sure to order solenoid valves for mounting at the same time while referring to the ordering example.

How to Order

SS5J3 - **60S** **V2** **D** - **05** **U**

Series	
2	SJ2000
3	SJ3000 (SJ2000/3000 mixed)

Mixed mounting type	
Nil	Standard (Note 1)
M	Mixed mounting (Note 2)

Note 1) There is no need to enter anything when you operate either the SJ2000 or SJ3000 series alone.

Note 2) Enter "M" when the SJ2000 or SJ3000 series will be mounted on the same manifold base together.

Component module	
0	Without SI unit
V2	CC-Link compliant (32 points)
Q2	DeviceNet compliant (32 points)
Q3	DeviceNet compliant (16 points)

* Please contact SMC for a specification of the SI unit.

Communication connector spec.	
Nil	T-branch type
A	Straight type

* Communication connector, power connector are shipped together with manifold. Power connector is available of straight type only.

SI unit common spec.	
Nil	Positive common
N	Negative common

Unit mounting position	
D	D side

Symbol	Stations	Note
01	1 station	Up to 32 solenoids possible.
⋮	⋮	
32	32 stations	

* The number of the blanking block assembly is also included. Since single and double wiring are available with the blanking block assembly, select a model compatible with the valve wiring spec. planned for the future. (Refer to page 89.)

DIN rail length specified		
Nil	Standard length	
2	2 stations	Specify a longer rail than the
⋮	⋮	⋮
32	32 stations	standard length.

* Specify the valve stations not exceeding the maximum stations.

SUP/EXH block fitting spec.	
Nil	Straight fitting
L	Elbow fitting (Upward)
B	Elbow fitting (Downward)

* There is no need to enter anything when the SUP/EXH block mounting position "M" is selected.

Pilot spec.	
Nil	Internal pilot
S	Internal pilot/Built-in silencer
R	External pilot
RS	External pilot/Built-in silencer

* There is no need to enter anything when the SUP/EXH block mounting position "M" is selected.

* For built-in silencers, the 3/5(E) ports are plugged.

How to Order Manifold Assembly

Ordering example (SS5J3-60SV2□-□)

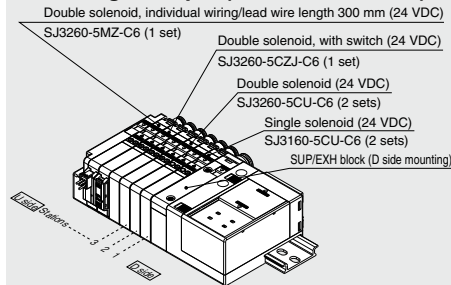

- SS5J3-60SV2-D06 ...1 set (Manifold part no.)**
- * SJ3160-5CU-C6 2 sets (Single solenoid part no.)
 - * SJ3260-5CU-C6 2 sets (Double solenoid part no.)
 - * SJ3260-5CZJ-C6 1 set (Double solenoid, with switch part no.)
 - * SJ3260-5MZ-C6 1 set (Double solenoid, individual wiring/lead wire length 300 mm part no.)

The asterisk denotes the symbol for assembly. Prefix to the part no. of the solenoid valve, etc.

- * The valve arrangement is numbered as the 1st station from D side.
- * Indicate the valves to be attached below the manifold part number, in order starting from station 1 as shown in the drawing. In the case of complex arrangement, specify them in the manifold specification sheet.

Note) When ordering a manifold, specify the part nos. of valves to be mounted together. (An order cannot be placed with only the manifold part no.)

SUP/EXH block mounting position

U	U side (1 to 10 stations)
D	D side (1 to 10 stations)
B	Both sides (1 to 32 stations)
M*	Special specifications

* Specify the required specifications (including port sizes other than ø8) by means of the manifold specification sheet.

SI Unit Part No.

Symbol	Component module/Communication connector specifications	Common spec.	SI unit part no.
V2	CC-LINK compliant	NPN output (Positive common)	EX180-SMJ3
V2N	(32 points), T-branch type	PNP output (Negative common)	EX180-SMJ5
V2A	CC-LINK compliant	NPN output (Positive common)	EX180-SMJ3A
V2AN	(32 points), Straight type	NPN output (Negative common)	EX180-SMJ5A
Q2	DeviceNet compliant	NPN output (Positive common)	EX180-SDN3
Q2N	(32 points), T-branch type	PNP output (Negative common)	EX180-SDN5
Q2A	DeviceNet compliant	NPN output (Positive common)	EX180-SDN3A
Q2AN	(32 points), Straight type	PNP output (Negative common)	EX180-SDN5A
Q3	DeviceNet compliant	NPN output (Positive common)	EX180-SDN4
Q3N	(16 points), T-branch type	PNP output (Negative common)	EX180-SDN6
Q3A	DeviceNet compliant	NPN output (Positive common)	EX180-SDN4A
Q3AN	(16 points), Straight type	PNP output (Negative common)	EX180-SDN6A

Item	Specifications
Power source	Non-polar 24 VDC + 10%/−5%
for driving valve	With energy saving circuit (Continuous duty) 24 VDC + 10%/0%

Refer to page 786 and the Operation Manual for the details of EX180 Integrated-type (For Output) Serial Transmission System. Please download it via our website. <http://www.smcworld.com>

How to Order Solenoid Valves

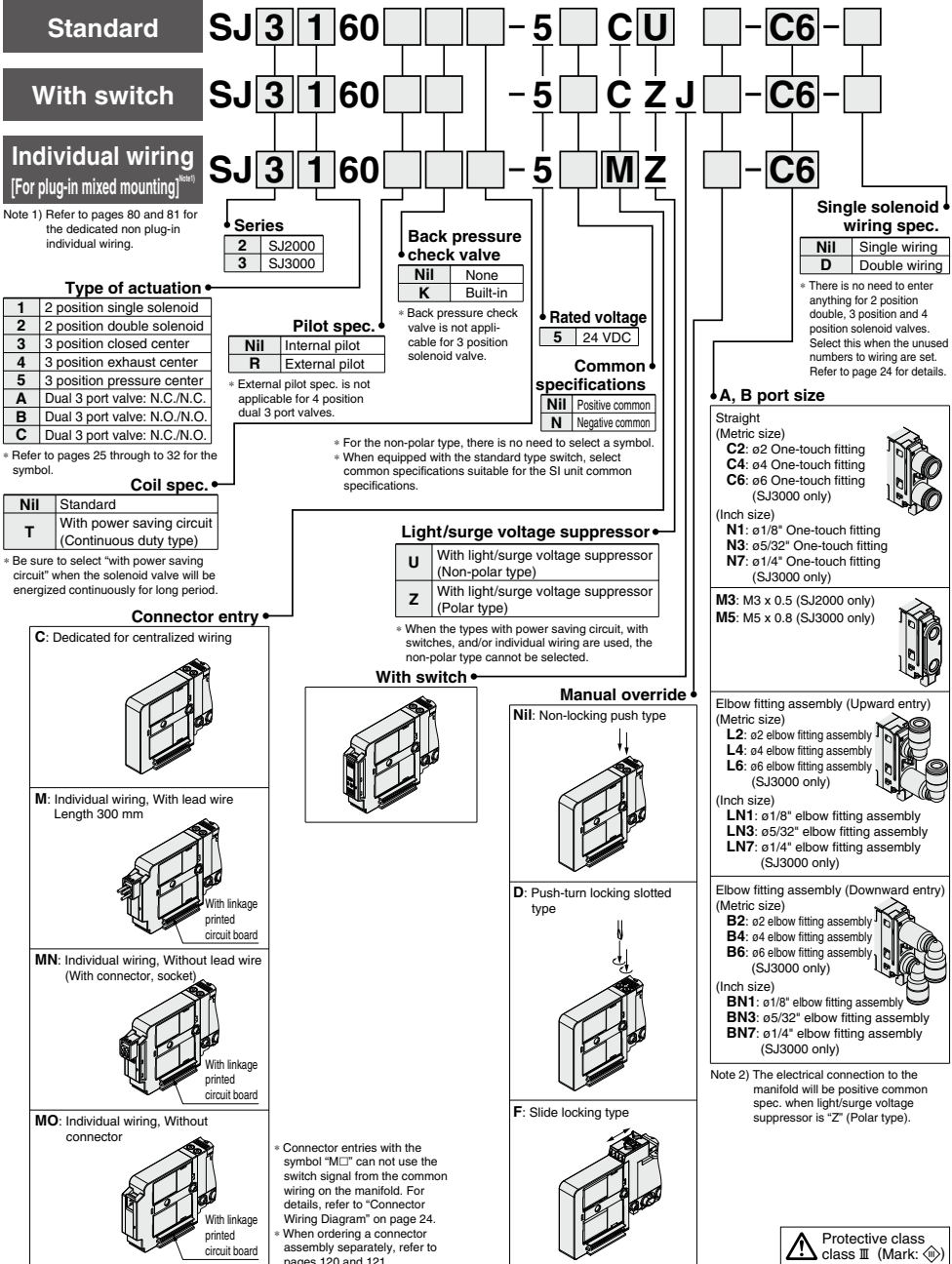

Standard

With switch

Individual wiring
[For plug-in mixed mounting]¹⁾

Note 1) Refer to pages 80 and 81 for the dedicated non plug-in individual wiring.

Type of actuation

1	2 position single solenoid
2	2 position double solenoid
3	3 position closed center
4	3 position exhaust center
5	3 position pressure center
A	Dual 3 port valve: N.C./N.C.
B	Dual 3 port valve: N.O./N.O.
C	Dual 3 port valve: N.C./N.O.

* Refer to pages 25 through to 32 for the symbol.

Coil spec.

Nil	Standard
T	With power saving circuit (Continuous duty type)

* Be sure to select "with power saving circuit" when the solenoid valve will be energized continuously for long period.

Series

2	SJ2000
3	SJ3000

Pilot spec.

Nil	Internal pilot
R	External pilot

* External pilot spec. is not applicable for 4 position dual 3 port valves.

Back pressure check valve

Nil	None
K	Built-in

* Back pressure check valve is not applicable for 3 position solenoid valve.

Rated voltage

5	24 VDC
---	--------

Common specifications

Nil	Positive common
N	Negative common

* For the non-polar type, there is no need to select a symbol.
* When equipped with the standard type switch, select common specifications suitable for the SI unit common specifications.

Light/surge voltage suppressor

U	With light/surge voltage suppressor (Non-polar type)
Z	With light/surge voltage suppressor (Polar type)

* When the types with power saving circuit, with switches, and/or individual wiring are used, the non-polar type cannot be selected.

C: Dedicated for centralized wiring

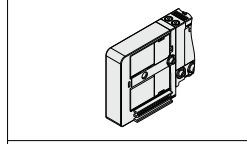

M: Individual wiring, With lead wire Length 300 mm

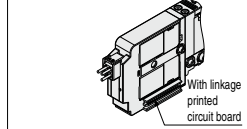

MN: Individual wiring, Without lead wire (With connector, socket)

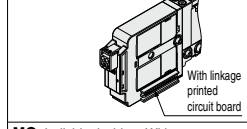

MO: Individual wiring, Without connector

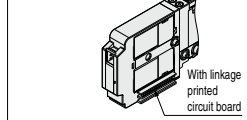

* Connector entries with the symbol "M□" can not use the switch signal from the common wiring on the manifold. For details, refer to "Connector Wiring Diagram" on page 24.
* When ordering a connector assembly separately, refer to pages 120 and 121.

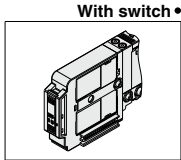

Manual override

Nil: Non-locking push type

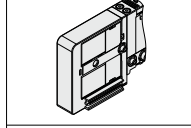

D: Push-turn locking slotted type

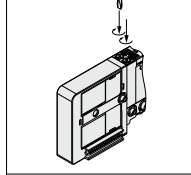

F: Slide locking type

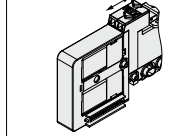

Single solenoid wiring spec.

Nil	Single wiring
D	Double wiring

* There is no need to enter anything for 2 position double, 3 position and 4 position solenoid valves. Select this when the unused numbers to wiring are set. Refer to page 24 for details.

A, B port size

Straight (Metric size)

C2: ø2 One-touch fitting
C4: ø4 One-touch fitting
C6: ø6 One-touch fitting (SJ3000 only)

(Inch size)

N1: ø1/8" One-touch fitting
N3: ø5/32" One-touch fitting (SJ3000 only)
N7: ø1/4" One-touch fitting (SJ3000 only)

M3: M3 x 0.5 (SJ2000 only)
M5: M5 x 0.8 (SJ3000 only)

Elbow fitting assembly (Upward entry) (Metric size)

L2: ø2 elbow fitting assembly
L4: ø4 elbow fitting assembly
L6: ø6 elbow fitting assembly (SJ3000 only)

(Inch size)

LN1: ø1/8" elbow fitting assembly
LN3: ø5/32" elbow fitting assembly
LN7: ø1/4" elbow fitting assembly (SJ3000 only)

Elbow fitting assembly (Downward entry) (Metric size)

B2: ø2 elbow fitting assembly
B4: ø4 elbow fitting assembly
B6: ø6 elbow fitting assembly (SJ3000 only)

(Inch size)

BN1: ø1/8" elbow fitting assembly
BN3: ø5/32" elbow fitting assembly
BN7: ø1/4" elbow fitting assembly (SJ3000 only)

Note 2) The electrical connection to the manifold will be positive common spec. when light/surge voltage suppressor is "Z" (Polar type).

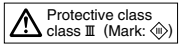

SJ2000/3000 Series

Dimensions: SJ2000 Series for EX180 Integrated-type (For Output) Serial Transmission System

SS5J2-60S □ □ -Stations U(S, R, RS)

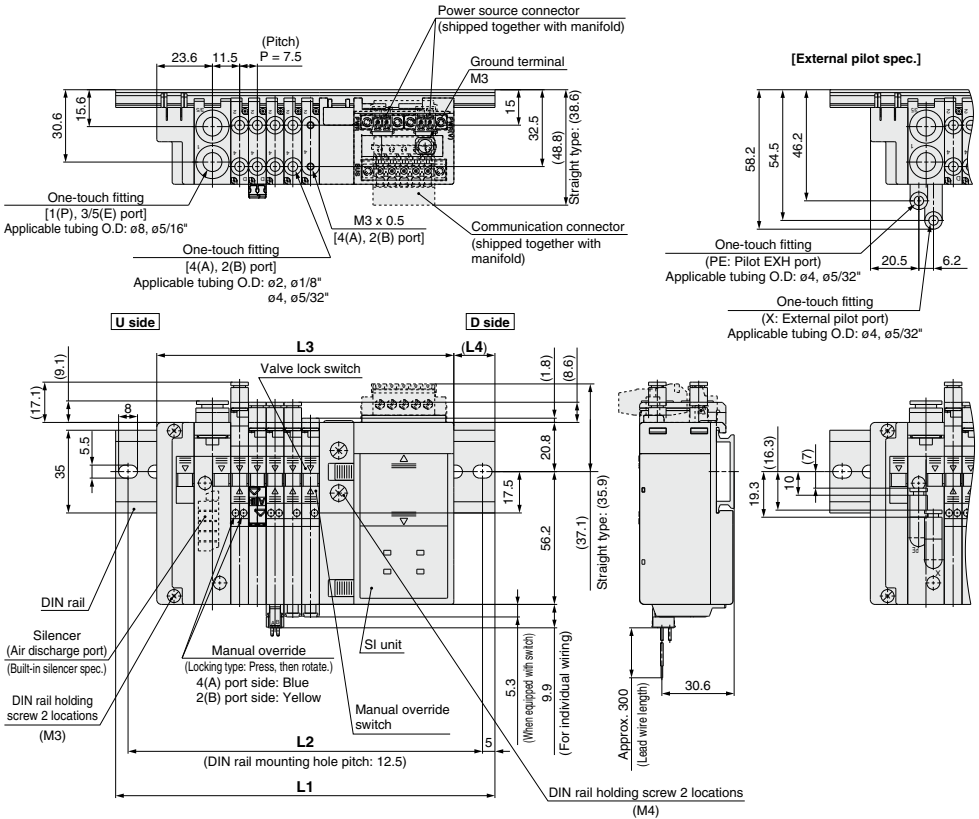

(Station n) --- (Station 1)

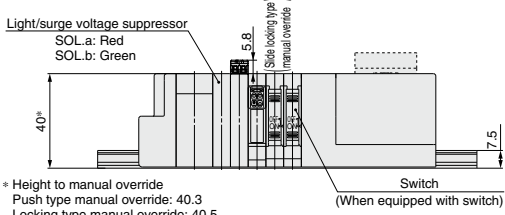

Note) Refer to page 50 for the dimensions of the manifold with elbow fittings and pages 786 to 788 for the details of SI unit.

L: Dimensions		n: Stations									
n	1	2	3	4	5	6	7	8	9	10	
L1	123	135.5	135.5	148	160.5	160.5	173	173	185.5	198	
L2	112.5	125	125	137.5	150	150	162.5	162.5	175	187.5	
L3	95.7	103.2	110.7	118.2	125.7	133.2	140.7	148.2	155.7	163.2	
L4	13.5	16	12.5	15	17.5	13.5	16	12.5	15	17.5	

SJ2000/3000 Series

Dimensions: SJ3000 Series for EX180 Integrated-type (For Output) Serial Transmission System

SS5J3-60S □ □ -Stations U(S, R, RS)

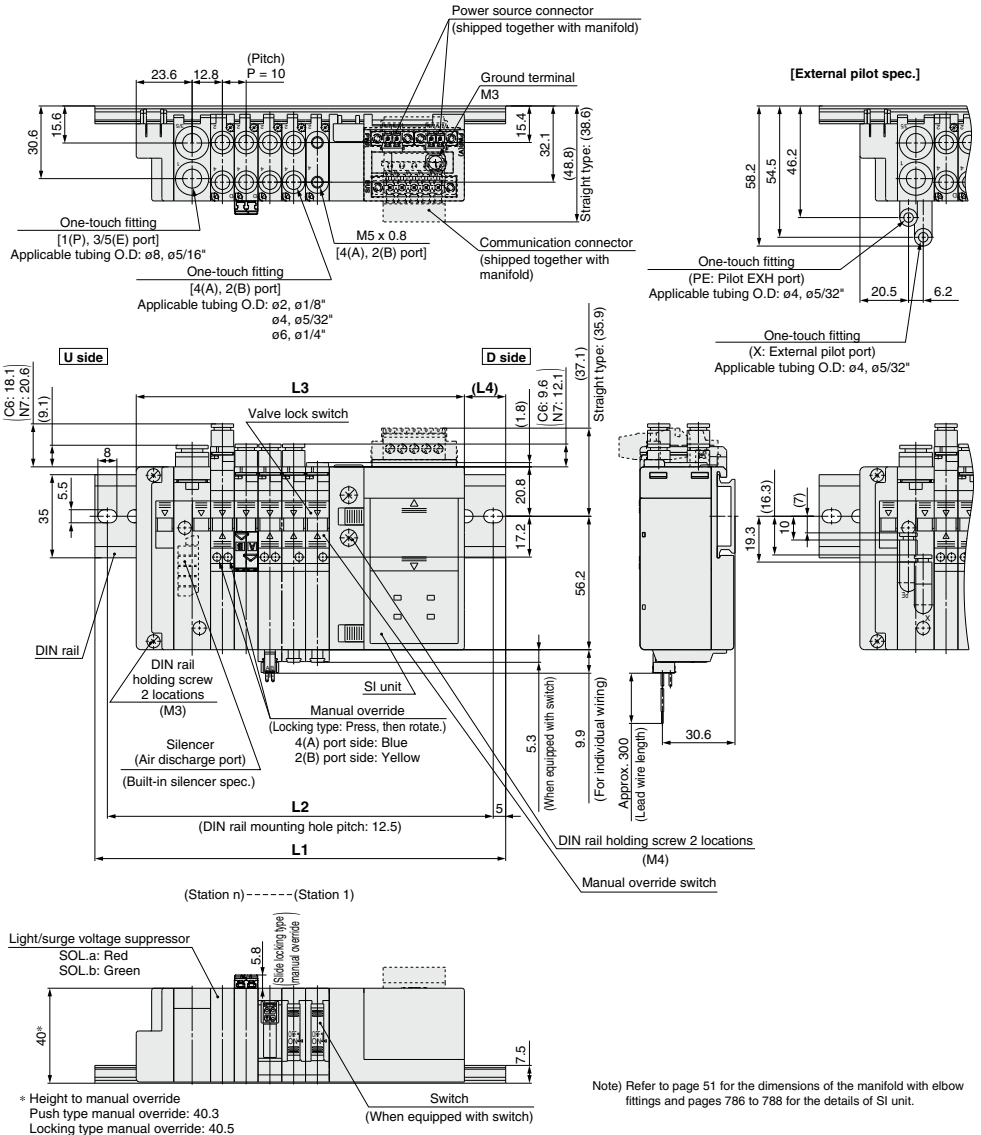

L: Dimensions

L	n	n: Stations									
		1	2	3	4	5	6	7	8	9	10
L1		123	135.5	148	160.5	173	173	185.5	198	210.5	223
L2		112.5	125	137.5	150	162.5	162.5	175	187.5	200	212.5
L3		98.2	108.2	118.2	128.2	138.2	148.2	158.2	168.2	178.2	188.2
L4		12.5	13.5	14.5	16	17	12	13	14	15.5	16.5

SJ2000/3000 Series

Dimensions: SJ2000/3000 Mixed Manifold

SS5J3-M60S□□-[Stations]U(S, R, RS)

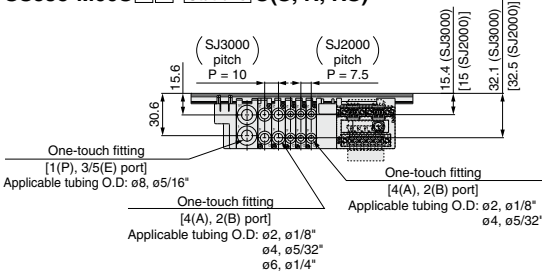

L dimension: Formula, L1 to L4
 $L3 = 7.5 \times n1 + 10 \times n2 + 88.2$
 $M = (L3 + 4)/12.5 + 1$
 Remove all numbers after the decimal.
 $L1 = M \times 12.5 + 23$
 $L2 = L1 - 10.5$
 $L4 = (L1 - L3)/2 - 2$

n1: Quantity of SJ2000
 n2: Quantity of SJ3000

* The dimensions of L1 to L4 for **SS5J3-M60S□□-[Stations]D** are the same as those of **SS5J3-M60S□□-[Stations]U**.

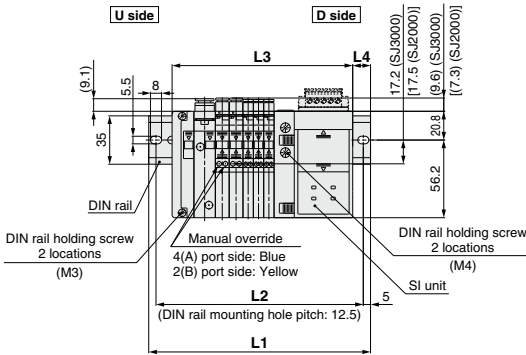

SS5J3-M60S□□-[Stations]B(S, R, RS)

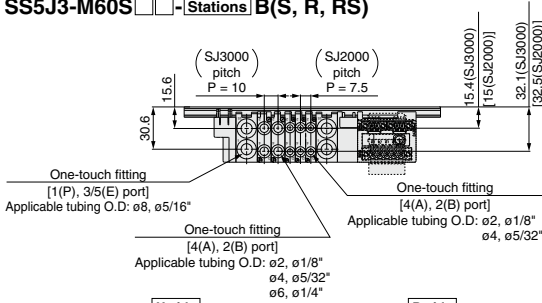

L dimension: Formula, L1 to L4
 $L3 = 7.5 \times n1 + 10 \times n2 + 103.7$
 $M = (L3 + 4)/12.5 + 1$
 Remove all numbers after the decimal.
 $L1 = M \times 12.5 + 23$
 $L2 = L1 - 10.5$
 $L4 = (L1 - L3)/2 - 2$

n1: Quantity of SJ2000
 n2: Quantity of SJ3000

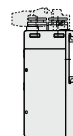
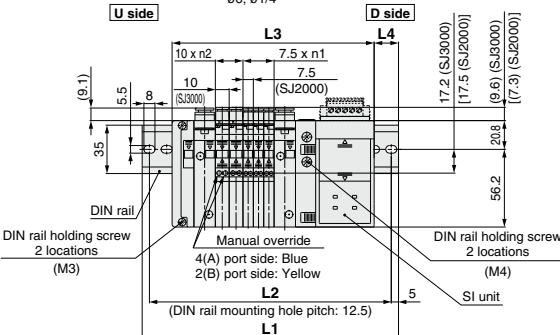

SJ

SY

SY

S0700

S0700

Plug-in Connector Type

EX510 Gateway-type Serial Transmission System



Type **60S6B**

SJ2000/3000 Series

An order cannot be placed with only the manifold part no. Be sure to order solenoid valves for mounting at the same time while referring to the ordering example.

How to Order Manifold

SS5J3 - **60S6B** **D** - **05** **D**

Manifold series

2	SJ2000
3	SJ3000 (SJ2000/3000 mixed)

Mixed mounting type

NII	Standard <small>Note 1)</small>
M	Mixed mounting <small>Note 2)</small>

Note 1) There is no need to enter anything when you operate either the SJ2000 or SJ3000 series alone.

Note 2) Enter "M" when the SJ2000 or SJ3000 series will be mounted on the same manifold base together.

SI unit common spec.

NII	Positive common
N	Negative common

Unit mounting position

D	D side
----------	--------

Valve stations

Symbol	No. of stations	Note
01	1 station	Up to 16 solenoids possible.
⋮	⋮	
16	16 stations	

* The number of the blanking block assembly is also included. Since single and double wiring are available with the blanking block assembly, select a model compatible with the valve wiring spec. planned for the future.

DIN rail length specified

NII	Standard length
2	2 stations Specify a longer rail than the standard length.
⋮	⋮
16	16 stations

* Specify the valve stations not exceeding the maximum stations.

SUP/EXH block fitting spec.

NII	Straight fitting With external pilot spec. X, PE port	
L	Elbow fitting (Upward) With external pilot spec. X, PE port	
B	Elbow fitting (Downward) With external pilot spec. X, PE port	

* There is no need to enter anything when the SUP/EXH block mounting position "M" is selected.

Pilot spec.

NII	Internal pilot
S	Internal pilot/Built-in silencer
R	External pilot
RS	External pilot/Built-in silencer

* There is no need to enter anything when the SUP/EXH block mounting position "M" is selected.

* For built-in silencers, the 3/5(E) ports are plugged.

SUP/EXH block mounting position

U	U side (1 to 10 stations)
D	D side (1 to 10 stations)
B	Both sides (1 to 16 stations)
M*	Special specifications

* Specify the required specifications (including port sizes other than ø8) by means of the manifold specification sheet.

How to Order Valve Manifold Assembly

Ordering example (SS5J3-60S6BD-□)

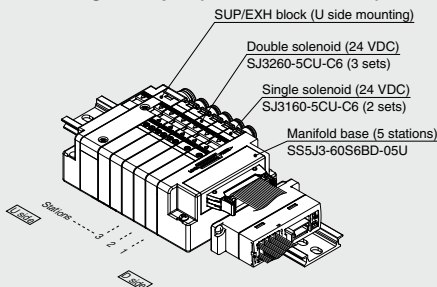

SS5J3-60S6BD-05U ... 1 set (Type 60S6B, 5-station manifold base part no.)
 * **SJ3160-5CU-C6** 2 sets (Single solenoid part no.)
 * **SJ3260-5CU-C6** 3 sets (Double solenoid part no.)

The asterisk denotes the symbol for assembly. Prefix to the part no. of the solenoid valve, etc.

* The valve arrangement is numbered as the 1st station from D side.

* Indicate the valves to be attached below the manifold part number, in order starting from station 1 as shown in the drawing. In the case of complex arrangement, specify them in the manifold specification sheet.

Note) When ordering a manifold, specify the part nos. of valves to be mounted together. (An order cannot be placed with only the manifold part no.)

SI Unit Part No.

Symbol	SI unit specifications	SI unit part no.	Page
NII	NPN output (Positive common)	EX510-S002C	P. 897
N	PNP output (Negative common)	EX510-S102C	

Refer to page 878 and the Operation Manual for the details of EX510 Gateway-type Serial Transmission System.

Please download it via our website. <http://www.smcworld.com>

How to Order Solenoid Valves

Standard
SJ 3 1 60 [] [] [] - 5 [] **C U** [] - **C6** - []

With switch
SJ 3 1 60 [] [] [] - 5 [] **C Z J** [] - **C6** - []

Individual wiring
 (For plug-in mixed mounting)TM
SJ 3 1 60 [] [] [] - 5 [] **M Z** [] - **C6** []

Series

2	SJ2000
3	SJ3000

Type of actuation

1	2 position single solenoid
2	2 position double solenoid
3	3 position closed center
4	3 position exhaust center
5	3 position pressure center
A	Dual 3 port valve: N.C./N.C.
B	Dual 3 port valve: N.O./N.O.
C	Dual 3 port valve: N.C./N.O.

Pilot spec.

Nil	Internal pilot
R	External pilot

Back pressure check valve

Nil	None
K	Built-in

Rated voltage

5	24 VDC
---	--------

Common specifications

Nil	Positive common
N	Negative common

Light/surge voltage suppressor

U	With light/surge voltage suppressor (Non-polar type)
Z	With light/surge voltage suppressor (Polar type)

Coil spec.

Nil	Standard
T	With power saving circuit (Continuous duty type)

Connector entry

C: Dedicated for centralized wiring

M: Individual wiring, With lead wire Length 300 mm

MN: Individual wiring, Without lead wire

MO: Individual wiring, Without connector

Manual override

Nil: Non-locking push type

D: Push-turn locking slotted type

F: Slide locking type

Single solenoid wiring spec.

Nil	Single wiring
D	Double wiring

A, B port size

Straight (Metric size)
C2: ø2 One-touch fitting
C4: ø4 One-touch fitting
C6: ø6 One-touch fitting (SJ3000 only)

(Inch size)
N1: ø1/8" One-touch fitting
N3: ø5/32" One-touch fitting (SJ3000 only)
N7: ø1/4" One-touch fitting (SJ3000 only)

M3: M3 x 0.5 (SJ2000 only)
M5: M5 x 0.8 (SJ3000 only)

Elbow fitting assembly (Upward entry) (Metric size)
L2: ø2 elbow fitting assembly
L4: ø4 elbow fitting assembly
L6: ø6 elbow fitting assembly (SJ3000 only)

(Inch size)
LN1: ø1/8" elbow fitting assembly
LN3: ø5/32" elbow fitting assembly
LN7: ø1/4" elbow fitting assembly (SJ3000 only)

Elbow fitting assembly (Downward entry) (Metric size)
B2: ø2 elbow fitting assembly
B4: ø4 elbow fitting assembly
B6: ø6 elbow fitting assembly (SJ3000 only)

(Inch size)
BN1: ø1/8" elbow fitting assembly
BN3: ø5/32" elbow fitting assembly
BN7: ø1/4" elbow fitting assembly (SJ3000 only)

SJ

SY

SY

S0700

S0700

Note) Refer to pages 80 and 81 for the dedicated non plug-in individual wiring.

* External pilot spec. is not applicable for 4 position solenoid dual 3 port valves.

* For the non-polar type, there is no need to select a symbol.

* When equipped with the standard type switch, select common specifications suitable for the SI unit common specifications.

* Refer to pages 25 through to 32 for the symbol.

* Be sure to select "with power saving circuit" when the solenoid valve will be energized continuously for long period.

* When the types with power saving circuit, with switches, and individual wiring are used, the non-polar type cannot be selected.

* Connector entries with the symbol "M" can not use the switch signal from the common wiring on the manifold. For details, refer to "Connector Wiring Diagram" on page 24.

* When ordering a connector assembly separately, refer to pages 120 and 121.

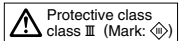

SJ2000/3000 Series

Dimensions: SJ2000 Series for EX510 Gateway-type Serial Transmission System

SS5J2-60S6B □ D - Stations U - □

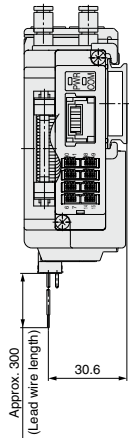
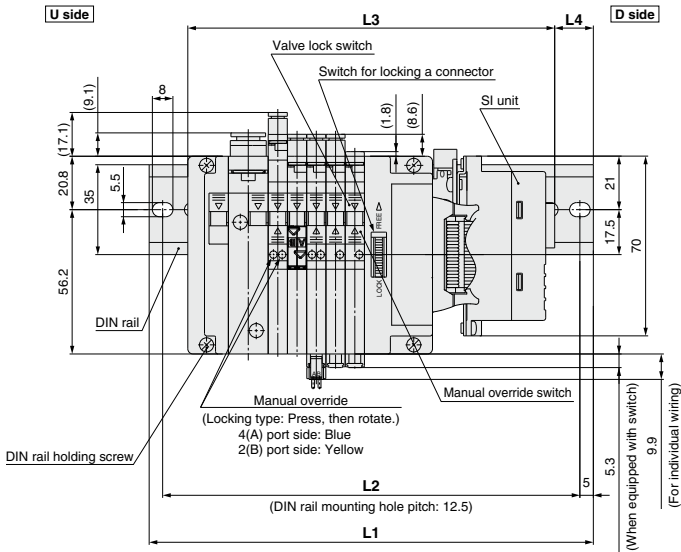
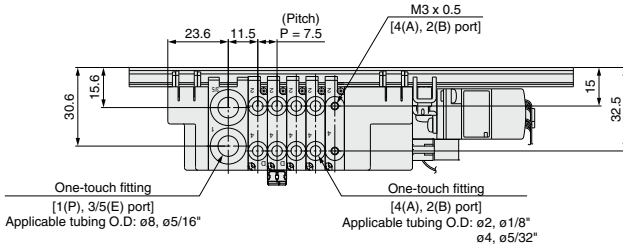

(Station n) ----- (Station 1)

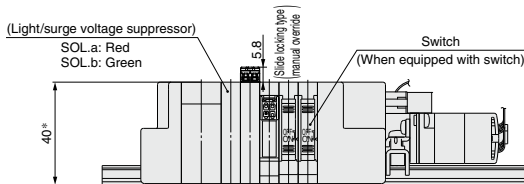

* Height to manual override
Push type manual override: 40.3
Locking type manual override: 40.5

Note) Refer to page 62 for the external pilot specifications, page 50 for the dimensions of the manifold with elbow fittings, and pages 878 to 906 for the details of SI unit.

L: Dimensions

n: Stations

L \ n	1	2	3	4	5	6	7	8	9	10
L1	148	148	160.5	160.5	173	185.5	185.5	198	198	210.5
L2	137.5	137.5	150	150	162.5	175	175	187.5	187.5	200
L3	112.9	120.4	127.9	135.4	142.9	150.4	157.9	165.4	172.9	180.4
L4	17.5	14	16.5	12.5	15	17.5	14	16.5	12.5	15

Dimensions: SJ2000 Series for EX510 Gateway-type Serial Transmission System

SS5J2-60S6B **D-** **Stations** **B-**

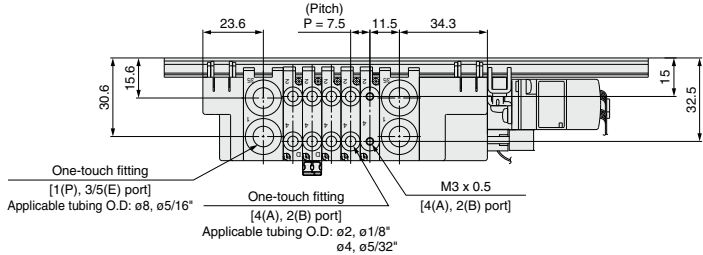

U side

D side

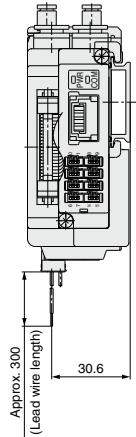
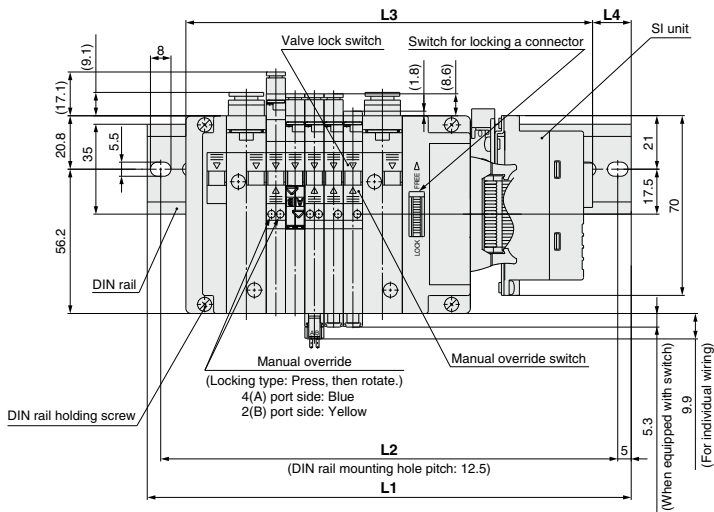

(Station n) ----- (Station 1)

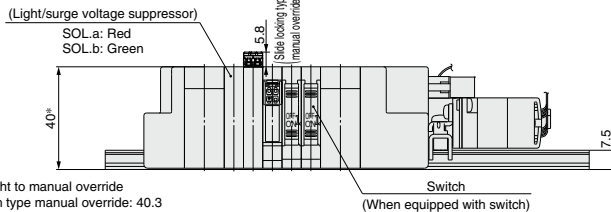

* Height to manual override
 Push type manual override: 40.3
 Locking type manual override: 40.5

Note) Refer to page 63 for the external pilot specifications, page 50 for the dimensions of the manifold with elbow fittings, and pages 878 to 906 for the details of SI unit.

L: Dimensions

n: Stations

L \ n	1	2	3	4	5	6	7	8	9	10	11	12	13	14	15	16
L1	160.5	160.5	173	185.5	185.5	198	198	210.5	223	223	235.5	248	248	260.5	260.5	273
L2	150	150	162.5	175	175	187.5	187.5	200	212.5	212.5	225	237.5	237.5	250	250	262.5
L3	128.4	135.9	143.4	150.9	158.4	165.9	173.4	180.9	188.4	195.9	203.4	210.9	218.4	225.9	233.4	240.9
L4	16	12.5	15	17.5	13.5	16	12.5	15	17.5	13.5	16	18.5	15	17.5	13.5	16

Dimensions: SJ3000 Series for EX510 Gateway-type Serial Transmission System

SS5J3-60S6B □ **D-** Stations **B-** □

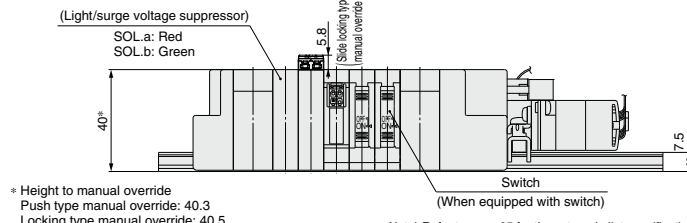
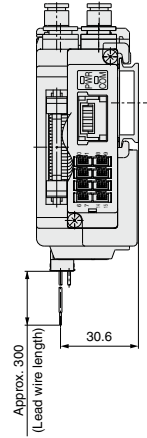
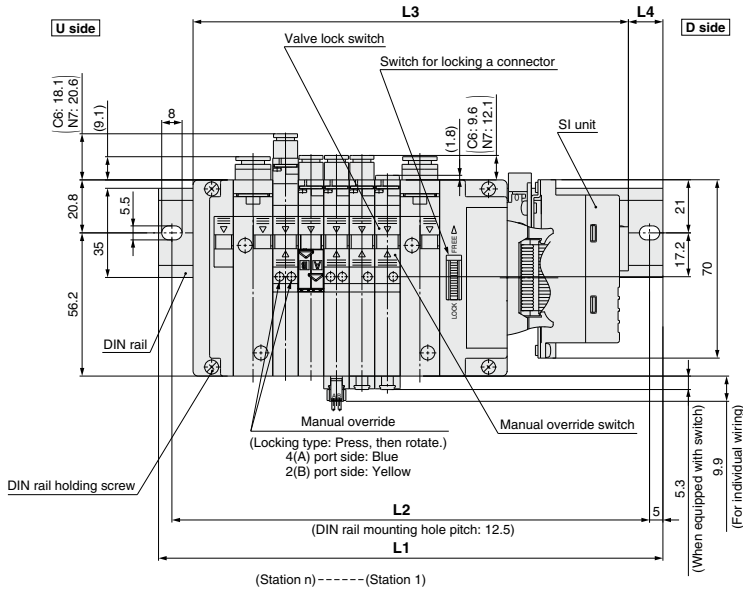
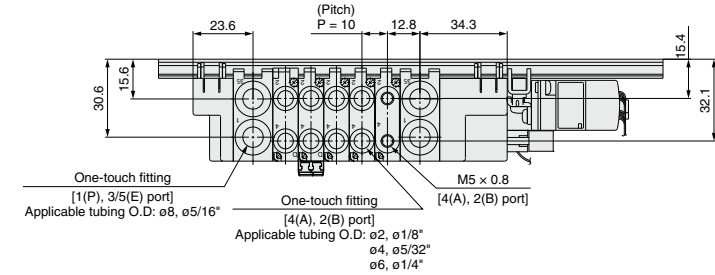

Note) Refer to page 65 for the external pilot specifications, page 51 for the dimensions of the manifold with elbow fittings, and pages 878 to 906 for the details of SI unit.

L: Dimensions

L	n: Stations															
	1	2	3	4	5	6	7	8	9	10	11	12	13	14	15	16
L1	160.5	173	185.5	185.5	198	210.5	223	235.5	248	248	260.5	273	285.5	298	298	310.5
L2	150	162.5	175	175	187.5	200	212.5	225	237.5	237.5	250	262.5	275	287.5	287.5	300
L3	130.9	140.9	150.9	160.9	170.9	180.9	190.9	200.9	210.9	220.9	230.9	240.9	250.9	260.9	260.9	280.9
L4	15	16	17.5	12.5	13.5	15	16	17.5	18.5	13.5	15	16	17.5	18.5	18.5	15

SJ2000/3000 Series

Dimensions: SJ2000/3000 Mixed Manifold for EX510 Gateway-type Serial Transmission System

SS5J3-M60S6B □ D- [Stations] U- □

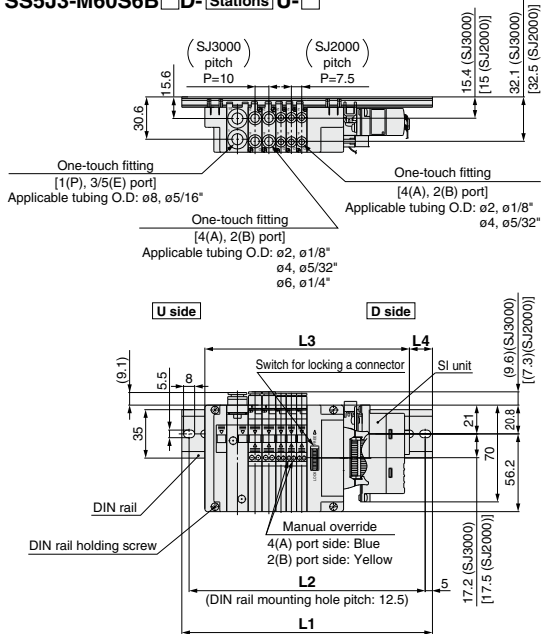

L dimension: Formula, L1 to L4
 $L3 = 7.5 \times n1 + 10 \times n2 + 105.4$
 $M = (L3 + 4) / 12.5 + 1$
 Remove all numbers after the decimal.
 $L1 = M \times 12.5 + 23$
 $L2 = L1 - 10.5$
 $L4 = (L1 - L3) / 2 - 2$

n1: Quantity of SJ2000
 n2: Quantity of SJ3000

* The dimensions of L1 to L4 for SS5J3-M60S6B □ D- [Stations] D are the same as those of SS5J3-M60S6B □ D- [Stations] U.

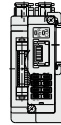

SS5J3-M60S6B □ D- [Stations] B- □

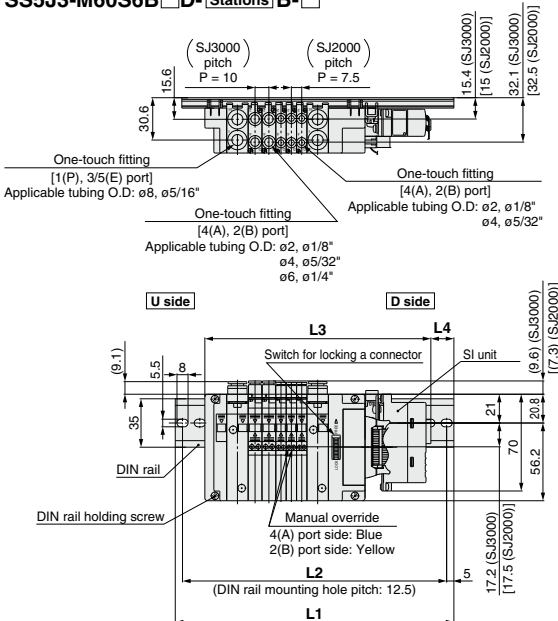

L dimension: Formula, L1 to L4
 $L3 = 7.5 \times n1 + 10 \times n2 + 120.9$
 $M = (L3 + 4) / 12.5 + 1$
 Remove all numbers after the decimal.
 $L1 = M \times 12.5 + 23$
 $L2 = L1 - 10.5$
 $L4 = (L1 - L3) / 2 - 2$

n1: Quantity of SJ2000
 n2: Quantity of SJ3000

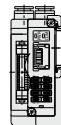

SJ2000/3000 Series Manifold Exploded View 1

Connector Type

Type 60P (Flat ribbon cable)
manifold

Type 60S (Plug-in, EX180 Integrated
type (for output) serial
transmission system)
manifold

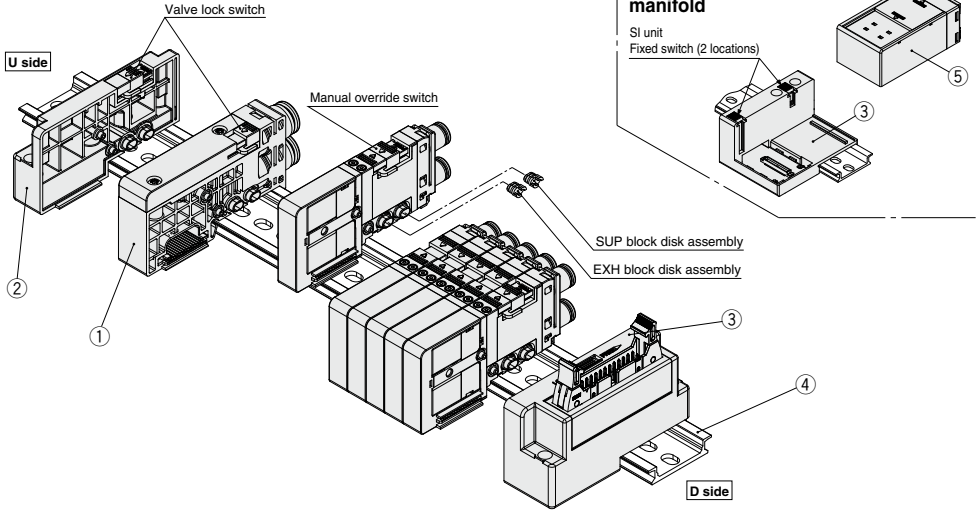

SJ
SY
SY
S0700
S0700

Component Parts/Plug-in (Connector Type)

No.	Description	Part no.	Note
1	SUP/EXH block assembly	Internal pilot	SJ3000-50-1A-□□ (Metric size)
		Internal pilot/Built-in silencer	SJ3000-50-1AS-□□ C6: With ø6 One-touch fitting (straight) C8: With ø8 One-touch fitting (straight)
		External pilot	SJ3000-50-1AR-□□ (X, PE port: Metric size ø4 Inch size ø5/32") L6: With ø6 One-touch fitting (elbow upward entry) L8: With ø8 One-touch fitting (elbow upward entry)
		External pilot/Built-in silencer	SJ3000-50-1ARS-□□ (X port: Metric size ø4 Inch size ø5/32") B6: With ø6 One-touch fitting (elbow downward entry) B8: With ø8 One-touch fitting (elbow downward entry)
		For different pressures, internal pilot ^{Note 1)}	SJ3000-50-3A-□□ (Inch size)
	For different pressures, internal pilot/Built-in silencer ^{Note 1)}	SJ3000-50-3AS-□□ N7: With 1/4" One-touch fitting (straight) N9: With 5/16" One-touch fitting (straight)	
2	End block assembly	SJ3000-53-1A	For U side
3	Connector block assembly	SJ3000-42-□A-□	Refer to the connector block assembly part no. shown below.
4	DIN rail	VZ1000-11-1-□	Refer to page 90.
5	SI unit	EX180-□□	Refer to the SI unit part numbers on page 60.

Note 1) The valves cannot be operated only with the SUP/EXH block assembly for different pressure, select them in combination with the SUP/EXH block assembly for internal/external pilot.

Note 2) Refer to page 88 about the SUP/EXH block disk assembly and method of handling of parts at different pressures.

Connector Block Assembly Part No.

Connector specifications	Mounting position	Part no.	Note
For D-sub connector (Locking bracket: Metric size thread)	D side	SJ3000-42-1A-□	□: 1 (Connector upward) □: 2 (Connector lateral)
For D-sub connector (Locking bracket: Unified thread)		SJ3000-42-1AU-□	
For flat ribbon cable 26 pins		SJ3000-42-2A-□	
For flat ribbon cable 20 pins		SJ3000-42-3A-□	
For flat ribbon cable 10 pins		SJ3000-42-4A-□	
For EX180 serial wiring ^{Note)}		SJ3000-42-20A	
For EX510 serial wiring ^{Note)}		SJ3000-42-3A-2	

Note) SI unit is not included.

Connector Block Assembly with SI Unit

Connector block assembly with EX180 serial wiring	D side	SJ3000-42-20A-□□	For details on □□ portion, refer to the SI unit part no. on page 60. Example: SJ3000-42-20A-V2 (CC-LINK compliant, T-branch type)
---	--------	------------------	--

SJ2000/3000 Series Manifold Exploded View 2

Cable Type

Type 60LP (Flat ribbon cable)
manifold

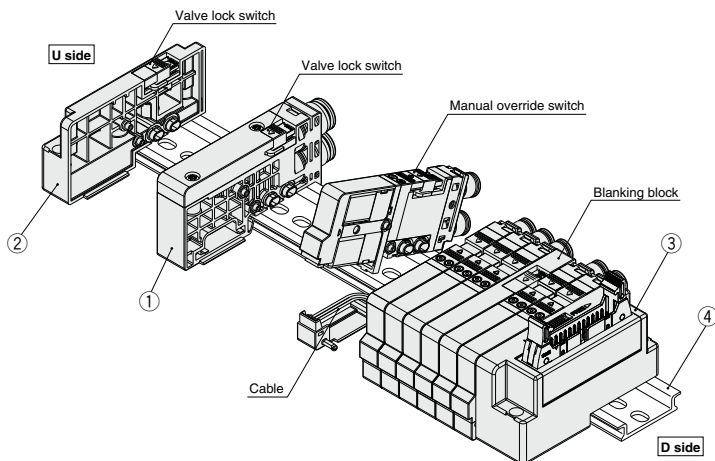

Component Parts/Plug-in (Cable Type)

No.	Description	Part no.	Note
1	Internal pilot	SJ3000-50-5A-□□	
	Internal pilot/Built-in silencer	SJ3000-50-5AS-□□	(Metric size)
	External pilot	SJ3000-50-5AR-□□	C6: With ø6 One-touch fitting (straight)
		(X, PE port: Metric size ø4 Inch size ø5/32*)	C8: With ø8 One-touch fitting (straight)
	External pilot/Built-in silencer	SJ3000-50-5ARS-□□	L6: With ø6 One-touch fitting (elbow upward entry)
For different pressures, internal pilot (Note 1)	SJ3000-50-6A-□□	L8: With ø8 One-touch fitting (elbow upward entry)	
		B6: With ø6 One-touch fitting (elbow downward entry)	
For different pressures, internal pilot/Built-in silencer (Note 1)	SJ3000-50-6AS-□□	B8: With ø8 One-touch fitting (elbow downward entry)	
		(Inch size)	
		N7: With 1/4" One-touch fitting (straight)	
		N9: With 5/16" One-touch fitting (straight)	
2	End block assembly	SJ3000-53-1A	For U side
3	Connector block assembly	SJ3000-42-□□A-□	Refer to the connector block assembly part no. shown below.
4	DIN rail	VZ1000-11-1-□	Refer to page 90.

Note 1) The valves cannot be operated only with the SUP/EXH block assembly for different pressure, select them in combination with the SUP/EXH block assembly for internal/external pilot.

Note 2) Refer to page 88 about the SUP/EXH block disk assembly and method of handling of parts at different pressures.

●Connector Block Assembly

SJ3000-42-□□ A □□ - □□ - □□ 05

Connector type

7	For D-sub connector	SJ3000 series
8	For flat ribbon cable 26 pins	
9	For flat ribbon cable 20 pins	
10	For flat ribbon cable 10 pins	
11	For D-sub connector	SJ2000 series
12	For flat ribbon cable 26 pins	
13	For flat ribbon cable 20 pins	
14	For flat ribbon cable 10 pins	

* All connector block assembly mounting positions become the D side.

* The connector block assembly includes the cables necessary for the number of stations.

Locking bracket

Nil	Metric size thread
U	Unified thread

* D-sub connector only.

Valve stations

02 to 10	For D-sub connector	All double wiring
02 to 20		All single wiring
02 to 10	For flat ribbon cable 26 pins	All double wiring
02 to 20		All single wiring
02 to 09	For flat ribbon cable 20 pins	All double wiring
02 to 18		All single wiring
02 to 04	For flat ribbon cable 10 pins	All double wiring
02 to 08		All single wiring

Wiring

Nil	All double wiring
S	All single wiring

Connector entry direction

1	Upward
2	Lateral

Connector Type

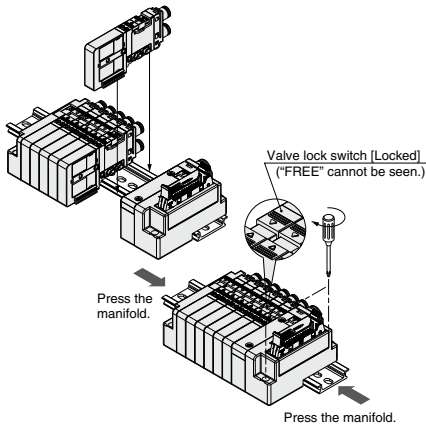
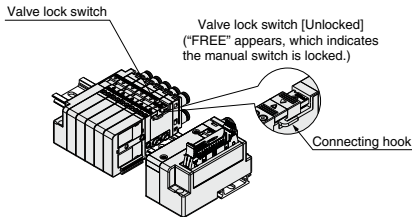
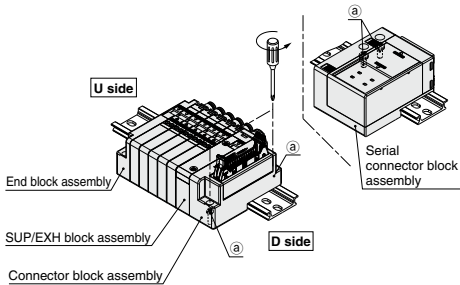

1 Loosen threads **a**, which are fixed onto the DIN rail (two locations on one side).

2 In the direction of the coil, slide the valve where the station is desired to add and the valve lock switch on each block.

If blocks are removed without completely releasing the valve lock switch, the connection hook of that switch could be damaged or deformed.

3 Install an additional valve or an SUP/EXH block assembly block on the DIN rail.

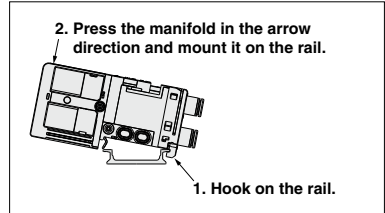

A manifold equipped with a valve or a block assembly can be mounted on the DIN rail. However, a serial connector block assembly cannot be mounted on the DIN rail when it is connected with another block; the serial connector block must be mounted separately.

4 Press the valves and block assemblies to each other for connection. Press the valve lock switch in the cylinder port direction until it does not go any further. Fasten threads **a** onto the DIN rail.

After fixing the connector block assembly, fasten the threads onto the end block assembly while holding it lightly by hand. This is necessary to improve sealing.

Caution (D-sub, Connector block assembly for flat ribbon cable, End block assembly M3: 0.6 N·m
Connector block assembly for EX180 serial wiring M4: 1.4 N·m
Mounting bracket for EX510 serial wiring M4: 0.6 N·m)

Caution

- When increasing the number of stations from 10 or below to 11 or above, increase the number of SUP/EXH block assemblies as well.
- Be sure to turn off the power and stop the supply of air before disassembly. Furthermore, since air may remain inside the actuator, piping and manifold, confirm that the air is completely exhausted before performing any work.
- After assembly and disassembly, air leakage could occur if blocks are not well connected or a thread is not tightly fastened onto the end block assembly. Before supplying air, make sure that no gaps exist in between blocks and that the valve and block are tightly fastened onto the DIN rail. Also, make sure that air is not leaking before use.
- For the SJ3A6 series manifold with vacuum release valve with restrictor, there is no valve lock switch for connecting, so when mounting, tighten the screws after checking that there are no gaps between valves.

SJ
SY
SY
S0700
S0700

Cable Type

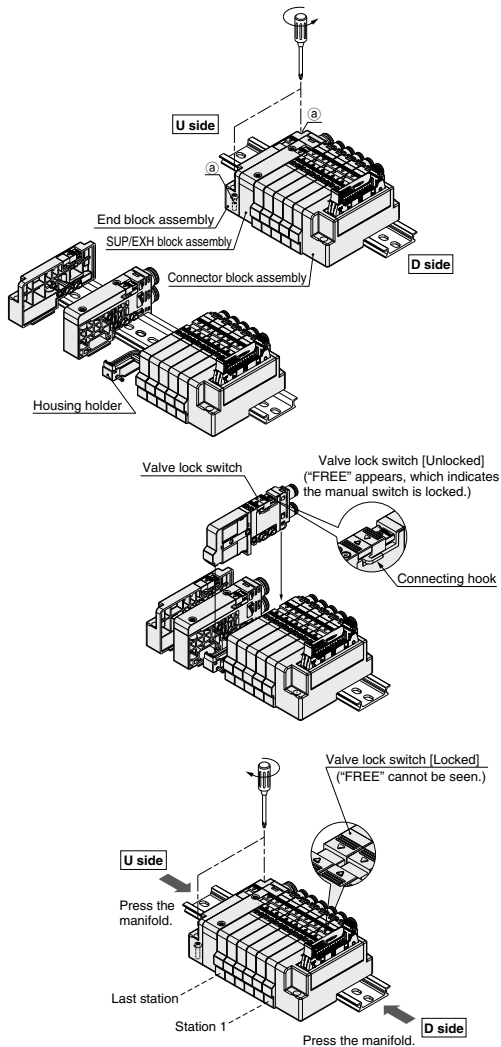

Caution

To increase a manifold station, a housing holder (refer to the table below) is required in addition to the solenoid valve.

For the manifold with less than the maximum stations, spare housing (for one station) for adding the manifold station is stored in the housing holder of the last station or the SUP/EXH block assembly. To increase a manifold station, follow the steps below to disassemble and reassemble the manifold.

Series	Housing holder part no.	Material	Note
SJ2000	SJ2000-86-1	Resin	White
SJ3000	SJ3000-86-1		

1 Loosen threads ①, which are fixed onto the DIN rail (two locations).

[Note: To replace the DIN rail, also loosen the screws (2 locations) on the connector block assembly.]

2 Slide the valve lock switch on each block toward the coil, and then remove the end block assembly and SUP/EXH block assembly.

3 Take out the stored housing for adding the manifold station and assemble it to a newly added housing holder. Insert this housing holder next to the current housing holder.

How to mount the housing

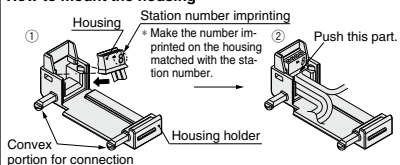

- Mount the housing in the arrow direction.
- Push in the housing securely using a flat blade screwdriver.

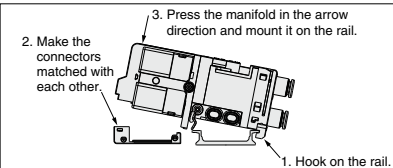

4 Press the valves and block assemblies to each other for connection. Press the valve lock switch in the cylinder part direction until it does not go any further. Fasten threads ② onto the DIN rail. Connect the added valve and SUP/EXH block, and then fasten the DIN rail fixing screws on the end block on the U side.

After fixing the connector block assembly, fasten the threads onto the end block assembly while holding it lightly by hand. This is necessary to improve sealing.

Caution D-sub, Connector block assembly for flat ribbon cable, End block assembly M3: 0.6 N-m

Caution

- When increasing the number of stations from 10 or below to 11 or above, increase the number of SUP/EXH block assemblies as well. Add the valve to the U side of the last station, and then add the SUP/EXH block assembly to its U side. The SUP/EXH block cannot be added to a position adjacent to the connector block assembly or an intermediate position.
- Be sure to turn off the power and stop the supply of air before disassembly. Furthermore, since air may remain inside the actuator, piping and manifold, confirm that the air is completely exhausted before performing any work.
- After assembly and disassembly, air leakage could occur if blocks are not well connected or a thread is not tightly fastened onto the end block assembly. Before supplying air, make sure that no gaps exist in between blocks and that the valve and block are tightly fastened onto the DIN rail. Also, make sure that air is not leaking before use.
- For the SJ3A6 series manifold with vacuum release valve with restrictor, there is no valve lock switch for connecting, so when mounting, tighten the screws after checking that there are no gaps between valves.

Non Plug-in Individual Wiring Manifold

SJ2000/3000 Series

SJ
SY
SY
S0700
S0700

P.80 Individual Wiring

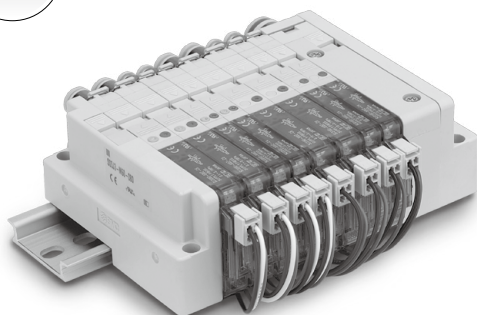

Non plug-in Individual Wiring

SJ2000/3000 Series

How to Order

An order cannot be placed with only the manifold part no. Be sure to order solenoid valves for mounting at the same time while referring to the ordering example.

Individual wiring manifold

SS5J 3 - 60 - 05 U

Series

2	SJ2000
3	SJ3000 (SJ2000/3000 mixed)

Mixed mounting type

Nil	Standard ^{Note 1)}
M	Mixed mounting ^{Note 2)}

Note 1) There is no need to enter anything when you operate either the SJ2000 or SJ3000 series alone.

Note 2) Enter "M" when the SJ2000 or SJ3000 series will be mounted on the same manifold base together.

Valve stations



Symbol	Stations
01	1 station
⋮	⋮
20	20 stations

DIN rail length specified

Nil	Standard length
2	2 stations
⋮	⋮
20	20 stations

* Specify the valve stations not exceeding the maximum stations.

SUP/EXH block fitting spec.

Nil	Straight fitting With external pilot spec. X, PE port	
L	Elbow fitting (Upward) With external pilot spec. X, PE port	
B	Elbow fitting (Downward) With external pilot spec. X, PE port	

* There is no need to enter anything when the SUP/EXH block mounting position "M" is selected.

Pilot spec.

Nil	Internal pilot
S	Internal pilot/Built-in silencer
R	External pilot
RS	External pilot/Built-in silencer

* There is no need to enter anything when the SUP/EXH block mounting position "M" is selected.
* For built-in silencers, the 3/5(E) ports are plugged.

SUP/EXH block mounting position

U	U side (1 to 10 stations)
D	D side (1 to 10 stations)
B	Both sides (1 to 20 stations)
M*	Special specifications

* Specify the required specifications (including port sizes other than ø8) by means of the manifold specification sheet.

How to Order Manifold Assembly

Ordering example (SS5J3-60-□)

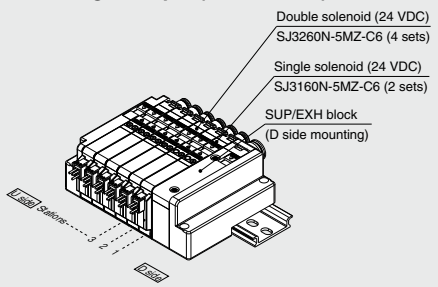

SS5J3-60-06D 1 set (Manifold part no.)
 * **SJ3160N-5MZ-C6** ... 2 sets (Single solenoid part no.)
 * **SJ3260N-5MZ-C6** ... 4 sets (Double solenoid part no.)
 * The asterisk denotes the symbol for assembly. Prefix to the part no. of the solenoid valve, etc.

* The valve arrangement is numbered as the 1st station from D side.
 * Indicate the valves to be attached below the manifold part number, in order starting from station 1 as shown in the drawing. In the case of complex arrangement, specify them in the manifold specification sheet.

How to Order Solenoid Valves

SJ 3 1 60 [] [] [] N-5 [] M Z [] -C6

Series

2	SJ2000
3	SJ3000

Type of actuation

1	2 position single solenoid
2	2 position double solenoid
3	3 position closed center
4	3 position exhaust center
5	3 position pressure center
A	Dual 3 port valve: N.C./N.C.
B	Dual 3 port valve: N.O./N.O.
C	Dual 3 port valve: N.C./N.O.

* Refer to pages 25 through to 32 for the symbol.

Pilot spec.

Nil	Internal pilot
R	External pilot

* External pilot spec. is not applicable for 4 position dual 3 port valves.

Back pressure check valve

Nil	None
K	Built-in

* Back pressure check valve is not applicable for 3 position solenoid valve.

Coil spec.

Nil	Standard
T	With power saving circuit (Continuous duty type)

* Be sure to select "with power saving circuit" when the solenoid valve will be energized continuously for long period.

Rated voltage

5	24 VDC
6	12 VDC

Common specifications

Nil	Positive common
N	Negative common

Non-plug-in

With light/surge voltage suppressor

Manual override

Connector entry

M: Individual wiring, With lead wire
Length 300 mm

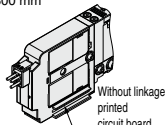

MN: Individual wiring, Without lead wire
(With connector, socket)

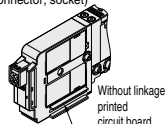

MO: Individual wiring, Without connector

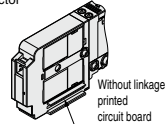

* When ordering a connector assembly separately, refer to pages 120 and 121.

Nil: Non-locking push type

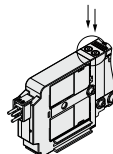

D: Push-turn locking slotted type

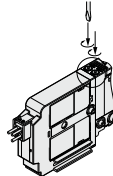

F: Slide locking type

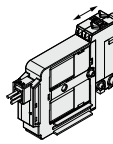

A, B port size

Straight
(Metric size)
C2: ø2 One-touch fitting
C4: ø4 One-touch fitting
C6: ø6 One-touch fitting (SJ3000 only)
(Inch size)
N1: ø1/8" One-touch fitting
N3: ø5/32" One-touch fitting
N7: ø1/4" One-touch fitting (SJ3000 only)



M3: M3 x 0.5 (SJ2000 only)
M5: M5 x 0.8 (SJ3000 only)



Elbow fitting assembly (Upward entry)
(Metric size)

L2: ø2 elbow fitting assembly
L4: ø4 elbow fitting assembly
L6: ø6 elbow fitting assembly (SJ3000 only)

(Inch size)
LN1: ø1/8" elbow fitting assembly
LN3: ø5/32" elbow fitting assembly
LN7: ø1/4" elbow fitting assembly (SJ3000 only)



Elbow fitting assembly (Downward entry)
(Metric size)

B2: ø2 elbow fitting assembly
B4: ø4 elbow fitting assembly
B6: ø6 elbow fitting assembly (SJ3000 only)

(Inch size)
BN1: ø1/8" elbow fitting assembly
BN3: ø5/32" elbow fitting assembly
BN7: ø1/4" elbow fitting assembly (SJ3000 only)



Protective class class III (Mark: )

SJ
SY
SY
S0700
S0700

SJ2000/3000 Series

Dimensions

SS5J2-60- [Stations] U (S, R, RS)

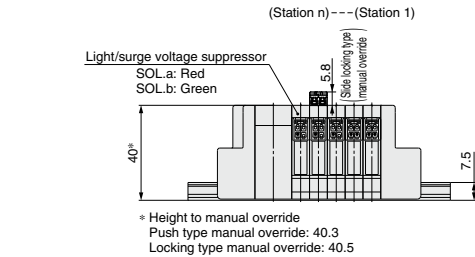
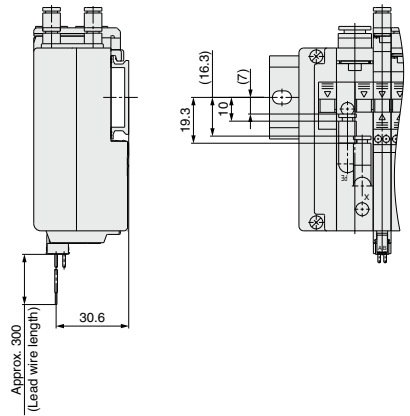
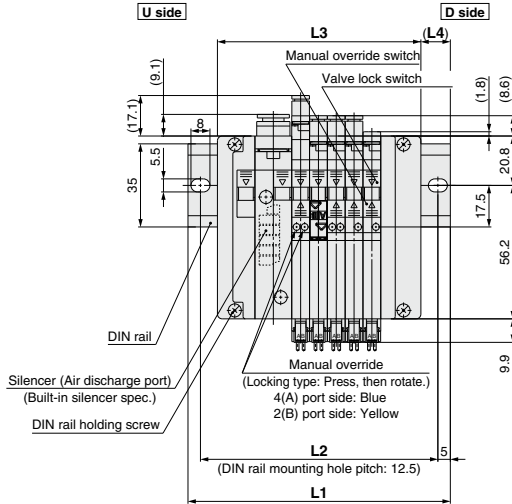
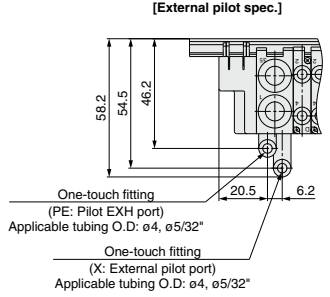
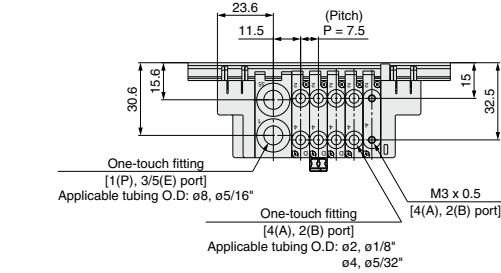

Note) For manifold dimensions including elbow fitting, refer to page 50.

L: Dimensions

n: Stations

L \ n	1	2	3	4	5	6	7	8	9	10
L1	85.5	98	98	110.5	110.5	123	135.5	135.5	148	148
L2	75	87.5	87.5	100	100	112.5	125	125	137.5	137.5
L3	55.7	63.2	70.7	78.2	85.7	93.2	100.7	108.2	115.7	123.2
L4	15	17.5	13.5	16	12.5	15	17.5	13.5	16	12.5

Dimensions

SS5J2-60- [Stations] B (S, R, RS)

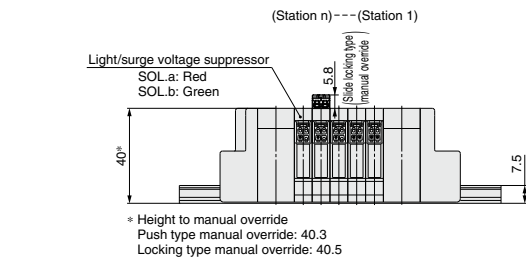
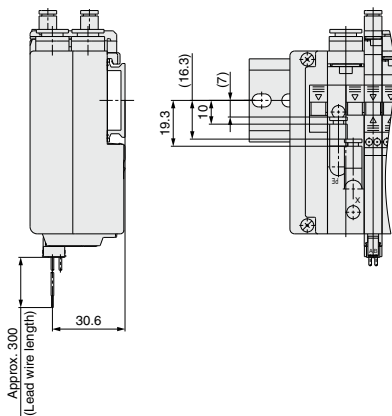
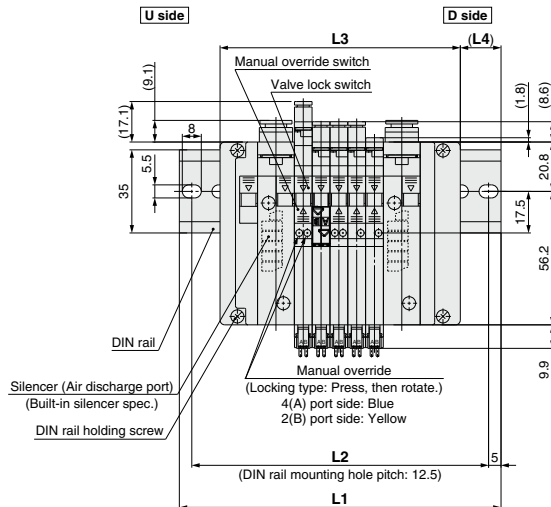
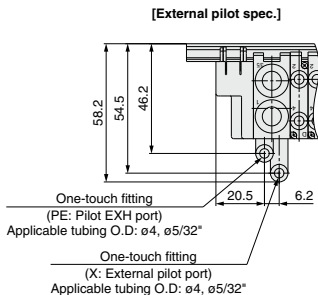
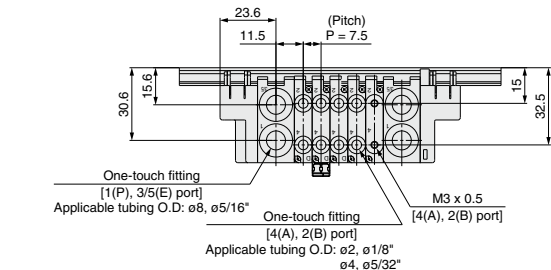

Note) For manifold dimensions including elbow fitting, refer to page 50.

L: Dimensions

n: Stations

L \ n	1	2	3	4	5	6	7	8	9	10	11	12	13	14	15	16	17	18	19	20
L1	98	110.5	110.5	123	135.5	135.5	148	148	160.5	173	173	185.5	185.5	198	210.5	210.5	223	223	235.5	248
L2	87.5	100	100	112.5	125	125	137.5	137.5	150	162.5	162.5	175	175	187.5	200	200	212.5	212.5	225	237.5
L3	71.2	78.7	86.2	93.7	101.2	108.7	116.2	123.7	131.2	138.7	146.2	153.7	161.2	168.7	176.2	183.7	191.2	198.7	206.2	213.7
L4	13.5	16	12	14.5	17	13.5	16	12	14.5	17	13.5	16	12	14.5	17	13.5	16	12	14.5	17

SJ2000/3000 Series

Dimensions

SS5J3-60- [Stations] U (S, R, RS)

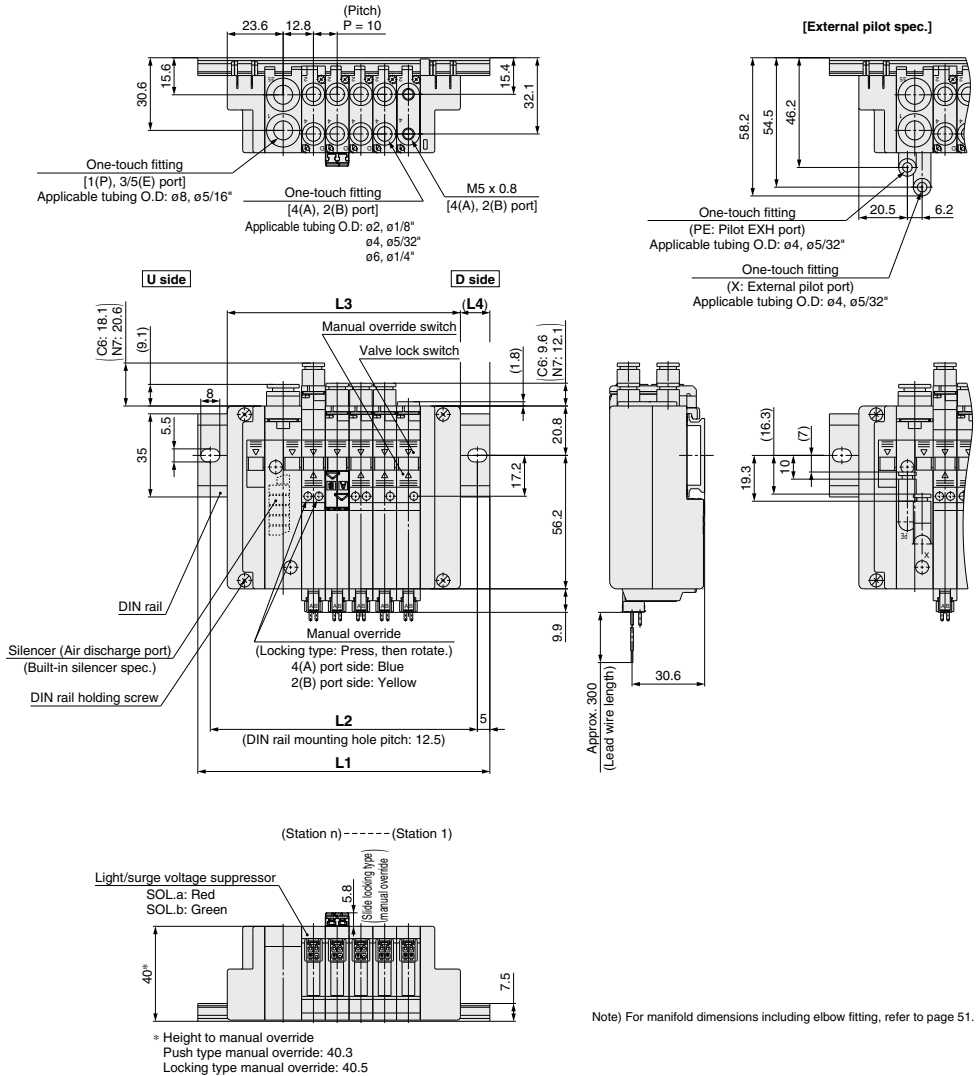

Note) For manifold dimensions including elbow fitting, refer to page 51.

L: Dimensions

n: Stations

L \ n	1	2	3	4	5	6	7	8	9	10
L1	85.5	98	110.5	123	123	135.5	148	160.5	173	185.5
L2	75	87.5	100	112.5	112.5	125	137.5	150	162.5	175
L3	58.2	68.2	78.2	88.2	98.2	108.2	118.2	128.2	138.2	148.2
L4	13.5	14.5	16	17	12	13	14	15.5	16.5	17.5

Dimensions

SS5J3-60- [Stations] B (S, R, RS)

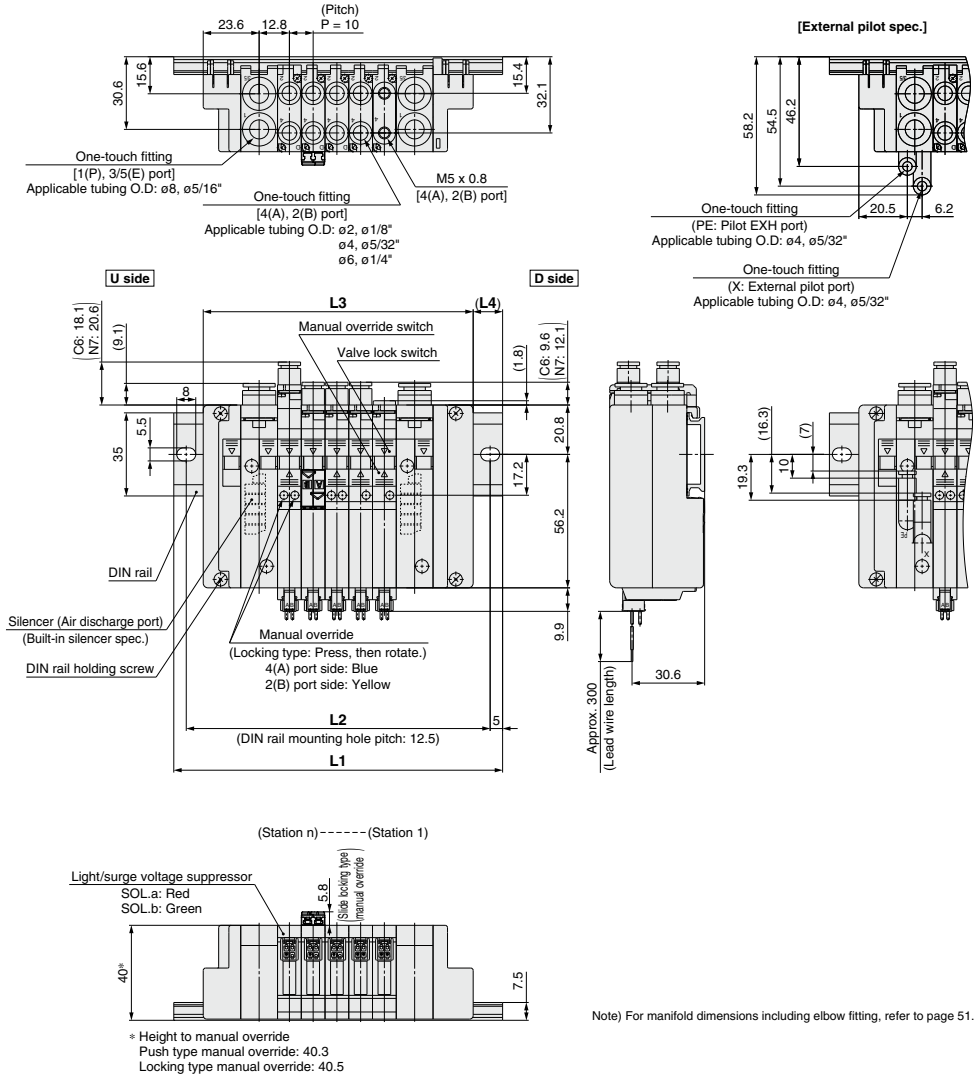

SJ
SY
SY
S0700
S0700

L: Dimensions

n: Stations

L	n	1	2	3	4	5	6	7	8	9	10	11	12	13	14	15	16	17	18	19	20
L1	98	110.5	123	135.5	148	148	160.5	173	185.5	198	210.5	210.5	223	235.5	248	260.5	260.5	273	285.5	298	
L2	87.5	100	112.5	125	137.5	137.5	150	162.5	175	187.5	200	200	212.5	225	237.5	250	250	262.5	275	287.5	
L3	73.7	83.7	93.7	103.7	113.7	123.7	133.7	143.7	153.7	163.7	173.7	183.7	193.7	203.7	213.7	223.7	233.7	243.7	253.7	263.7	
L4	12	13	14.5	15.5	16.5	11.5	12.5	14	15	16	17.5	12	13.5	14.5	15.5	17	11.5	13	14	15	

SJ2000/3000 Series

Dimensions: SJ2000/3000 Mixed Manifold

SS5J3-M60-Stations U (S, R, RS)

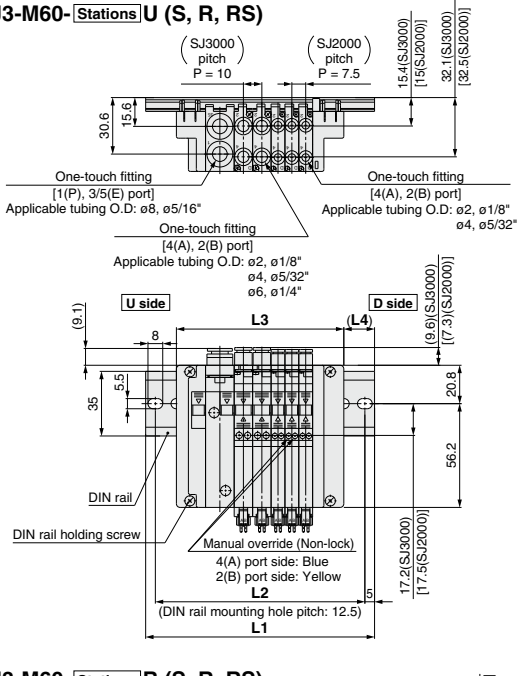

L dimension: Formula, L1 to L4
 $L3 = 7.5 \times n1 + 10 \times n2 + 48.2$
 $M = (L3 + 4) / 12.5 + 1$
 Remove all numbers after the decimal.
 $L1 = M \times 12.5 + 23$
 $L2 = L1 - 10.5$
 $L4 = (L1 - L3) / 2 - 2$

n1: Quantity of SJ2000
 n2: Quantity of SJ3000

* The dimensions of L1 to L4 for **SS5J3-M60-StationsD** are the same as those of **SS5J3-M60-StationsU**.

SS5J3-M60-Stations B (S, R, RS)

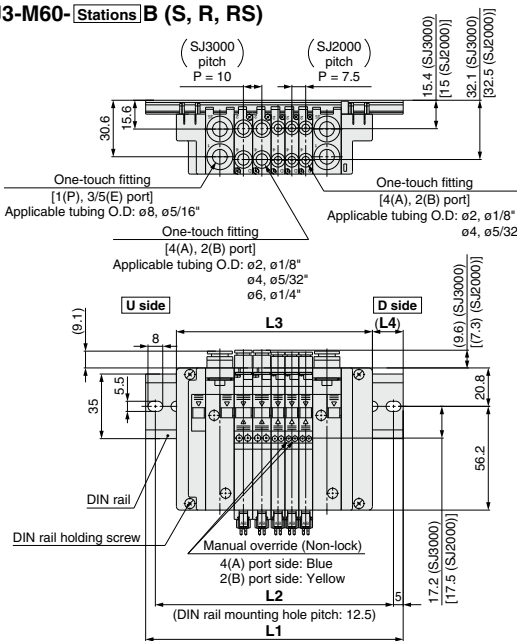

L dimension: Formula, L1 to L4
 $L3 = 7.5 \times n1 + 10 \times n2 + 63.7$
 $M = (L3 + 4) / 12.5 + 1$
 Remove all numbers after the decimal.
 $L1 = M \times 12.5 + 23$
 $L2 = L1 - 10.5$
 $L4 = (L1 - L3) / 2 - 2$

n1: Quantity of SJ2000
 n2: Quantity of SJ3000

SJ2000/3000 Series Manifold Exploded View

Individual Wiring

Type 60 individual wiring (Non plug-in) manifold

(Note) Refer to page 77 for "How to Increase Manifold Stations."

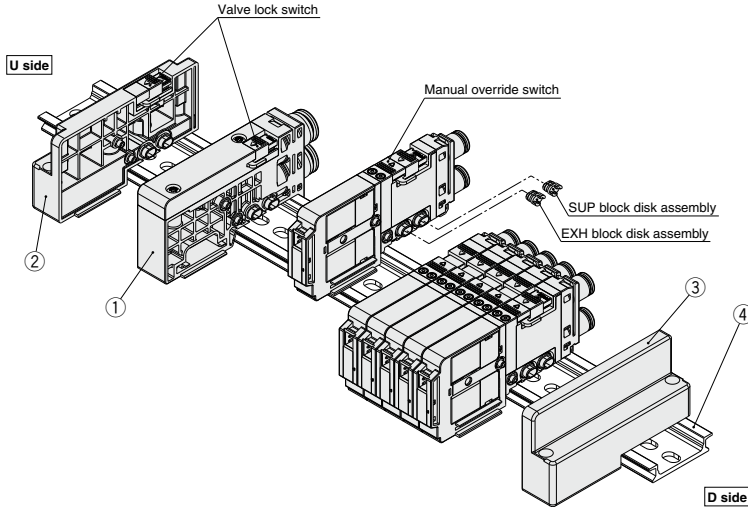

SJ
SY
SY
S0700
S0700

Component Parts/Individual Wiring (Non Plug-in)

No.	Description	Part no.	Note	
1	SUP/EXH block assembly	Internal pilot	SJ3000-50-5A-□□	
		Internal pilot/Built-in silencer	SJ3000-50-5AS-□□	
		External pilot	SJ3000-50-5AR-□□	(Metric size)
			(X, PE port: Metric size ø4 Inch size ø5/32*)	
		External pilot/Built-in silencer	SJ3000-50-5ARS-□□	(Inch size)
			(X port: Metric size ø4 Inch size ø5/32*)	
For different pressures, internal pilot ^{Note 1)}	SJ3000-50-6A-□□	N7: With 1/4" One-touch fitting (straight) N9: With 5/16" One-touch fitting (straight)		
For different pressures, internal pilot/Built-in silencer ^{Note 1)}	SJ3000-50-6AS-□□			
2	End block assembly	SJ3000-53-1A	For U side	
3	End block assembly	SJ3000-53-2A	For D side	
4	DIN rail	VZ1000-11-1-□	Refer to page 90.	

Note 1) The valves cannot be operated only with the SUP/EXH block assembly for different pressure, select them in combination with the SUP/EXH block assembly for internal/external pilot.

Note 2) Refer to page 88 about the SUP/EXH block disk assembly and method of handling of parts at different pressure.

SJ2000/3000 Series Manifold Options 1

Common to Connector Type/Cable Type/Individual Wiring

■ SUP block disk assembly

By placing a SUP block disk assembly in a manifold valve's pressure supply passage, two different high and low pressures can be supplied to one manifold. When supplying different pressures using the manifold of the internal pilot, fill out a manifold specification sheet to place an order for an SUP/EXH block assembly for the internal pilot specifications and another SUP/EXH block assembly for the different pressure internal pilot specifications (Refer to Circuit Diagram 1).



Series	Part no.
SJ2000	SJ3000-44-1A
SJ3000	

[Different pressure pneumatic circuit diagram]

● The SJ series supplies air to the pilot port of each valve using a 1(P) port of the SUP/EXH block assembly. When using in situations such as where there are different pressures, combine SUP/EXH block assemblies for internal pilot, external pilot and different-pressure by referring to the circuit below.

1. Different-pressure spec. using the internal pilot

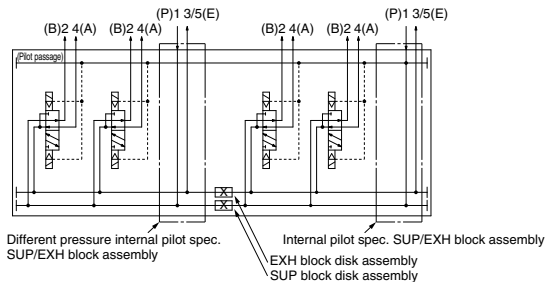

2. Different-pressure spec. using the external pilot (For using the SUP/EXH block assembly for external pilot)

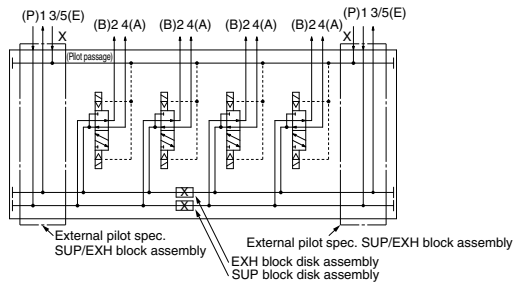

3. Different-pressure spec. using the external pilot (For using the SUP/EXH block assembly for different-pressure internal pilot spec.)

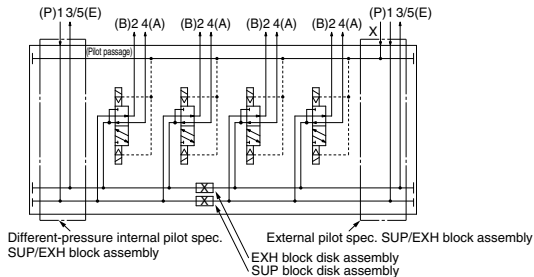

Note 1) When operating under the different-pressure spec., supply the higher pressure to the pilot passage.

Note 2) If there is a need to partition the pilot passage, consult SMC.

SJ2000/3000 Series Manifold Options 2

Common to Connector Type/Cable Type/Individual Wiring

■ EXH block disk assembly

By installing an EXH block disk in a manifold valve's exhaust passage, the valve's exhaust can be separated so that it will not affect other valves.



Series	Part no.
SJ2000	SJ3000-44-1A
SJ3000	

■ Label for block disk

These labels are attached to manifolds in which SUP and EXH block disks have been installed, in order to identify the installed locations. (Three sheets each included.)

Label for SUP/EXH block disk

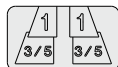

SJ3000-155-1A

Label for SUP block disk

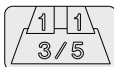

Label for EXH block disk

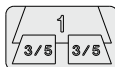

* When a block disk is concurrently ordered by specifying on the manifold specification sheet, etc., a label will be stuck on the position where block disk is mounted.

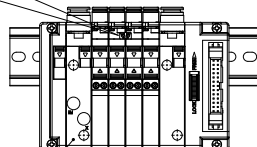

Internal pilot spec. for different pressure SUP/EXH block assembly

■ Blanking block assembly

These are mounted when later addition of valves is planned, etc.

<Connector type/Individual wiring>

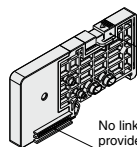

Valve lock switch

No linkage printed circuit board is provided for individual wiring.

<Cable type>

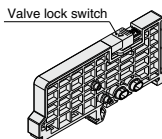

SJ2000

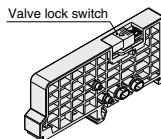

SJ3000

Series	Part no.	Note	Width
SJ2000	SJ3000-49-1A	Connector type (Single wiring)	7.5 mm
SJ3000	SJ3000-49-2A	Connector type (Double wiring)	
SJ3A6 (Note)	SJ3000-49-2A-N	Connector type (Double wiring)	
SJ2000 SJ3000	SJ3000-49-3A	Individual wiring	
SJ3A6 (Note)	SJ3000-49-3A-N		

Series	Part no.	Width
SJ2000	SJ2000-49-4A	7.5 mm
SJ3000	SJ3000-49-4A	10 mm
SJ3A6 (Note)	SJ3000-49-4A-N	

Note) Valve lock switch is not available for the SJ3A6.

Note) Valve lock switch is not available for the SJ3A6.

■ Silencer with One-touch fitting

This silencer can be mounted on the manifolds' port 3/5 (E: Exhaust) with a single touch.

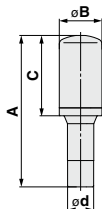

Series	Model	Effective area	A	B	C	ød
For SJ2000 SJ3000 (ø8)	AN15-C08	20 mm ²	45 mm	13 mm	20 mm	ø8

■ Plug

These are inserted in unused cylinder ports and P, E ports.

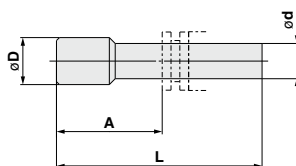

Dimensions

Applicable fitting size ød	Model	A	L	D
2	KJP-02	8.2	17	3
4	KQ2P-04	16	32	6
6	KQ2P-06	18	35	8
8	KQ2P-08	20.5	39	10
1/8"	KQ2P-01	16	31.5	5
5/32"	KQ2P-03	16	32	6
1/4"	KQ2P-07	18	35	8.5
5/16"	KQ2P-09	20.5	39	10

SJ2000/3000 Series Manifold Options 3

Common to Connector Type/Cable Type/Individual Wiring

■ DIN rail

VZ1000-11-1-□

● L dimension

* Enter a number from the DIN rail dimension table shown below.

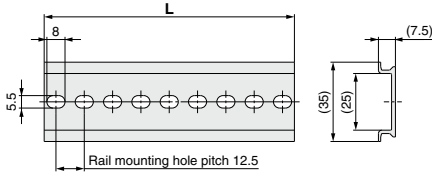

No.	S1	0	1	2	3	4	5	6	7	8	9
L dimension	85.5	98	110.5	123	135.5	148	160.5	173	185.5	198	210.5
Weight (g)	15.4	17.6	19.9	22.1	24.4	26.6	28.9	31.1	33.4	35.6	37.9

No.	10	11	12	13	14	15	16	17	18	19
L dimension	223	235.5	248	260.5	273	285.5	298	310.5	323	335.5
Weight (g)	40.1	42.4	44.6	46.9	49.1	51.4	53.6	55.9	58.1	60.4

No.	20	21	22	23	24	25	26	27	28	29
L dimension	348	360.5	373	385.5	398	410.5	423	435.5	448	460.5
Weight (g)	62.6	64.9	67.1	69.4	71.6	73.9	76.1	78.4	80.6	82.9

(Unit: mm)

■ Flat ribbon cable assembly

AXT100-FC-□- $\frac{1}{3}$

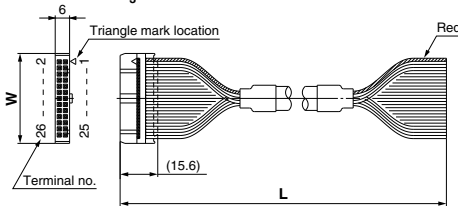

Flat Ribbon Cable Assembly

Cable length (L)	10 pins	20 pins	26 pins
1.5 m	AXT100-FC10-1	AXT100-FC20-1	AXT100-FC26-1
3 m	AXT100-FC10-2	AXT100-FC20-2	AXT100-FC26-2
5 m	AXT100-FC10-3	AXT100-FC20-3	AXT100-FC26-3
Connector width (W)	17.2	30	37.5

* For other commercial connectors, use a type with strain relief that conforms to MIL-C-83503.

Connector manufacturers:

- HIROSE ELECTRIC CO., LTD.
- 3M Japan Limited
- Fujitsu Limited
- Japan Aviation Electronics Industry, Limited
- J.S.T. Mfg. Co., Ltd.

■ D-sub connector (25 pins)/Cable assembly

AXT100-DS25- $\frac{015}{030}$
050

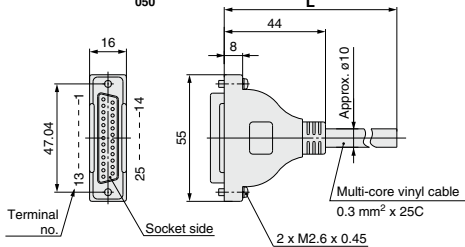

D-sub Connector Cable Assembly

Cable Color List of Each Terminal No.

Terminal no.	Lead wire color	Dot marking
1	Black	None
2	Brown	None
3	Red	None
4	Orange	None
5	Yellow	None
6	Pink	None
7	Blue	None
8	Purple	White
9	Gray	Black
10	White	Black
11	White	Red
12	Yellow	Red
13	Orange	Red
14	Yellow	Black
15	Pink	Black
16	Blue	White
17	Purple	None
18	Gray	None
19	Orange	Black
20	Red	White
21	Brown	White
22	Pink	Red
23	Gray	Red
24	Black	White
25	White	None

D-sub Connector Cable Assembly

Cable length (L)	Assembly part no.	Note
1.5 m	AXT100-DS25-015	Cable 25 cores x 24AWG
3 m	AXT100-DS25-030	
5 m	AXT100-DS25-050	

* For other commercial connectors, use a 25 pins type with female connector conforming to MIL-C-24308.

Electric Characteristics

Item	Characteristics
Conductor resistance $\Omega/\text{km}, 20^\circ\text{C}$	65 or less
Withstand pressure VAC, 1 min	1000
Insulation resistance $\text{M}\Omega/\text{km}, 20^\circ\text{C}$	5 or less

Note) The minimum bending radius for D-sub connector cables is 20 mm.

Connector manufacturers:

- HIROSE ELECTRIC CO., LTD.
- Fujitsu Limited
- Japan Aviation Electronics Industry, Limited
- J.S.T. Mfg. Co., Ltd.

SJ2000/3000 Series Manifold Options 4

Common to Connector Type/Cable Type/Individual Wiring

■ Dual flow fitting (Set for SJ3000 series)

SJ3000-120-1A-**C8**

↓ Port size

C8	ø8
N9	ø5/16"

This is a fitting for cylinder ports which enables simultaneous actuation and increase in flow rate of valves for 2 stations.
This is a One-touch fitting with port sizes of ø8 and ø5/16.

* When arranging mounted to the valve, arrange the valve part no. using the part no. without the One-touch fitting, and then add the part no. for the dual flow fitting.
If the arrangement is complicated, please specify them by means of the manifold specification sheet.

Ordering example

Valve type (without One-touch fitting)

SJ3160-5CU-[C0] 2 sets

* SJ3000-120-1A-C8 1 set

↳ The asterisk denotes the symbol for assembly.

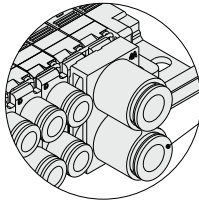

C8: ø8 One-touch fitting
N9: ø5/16" One-touch fitting

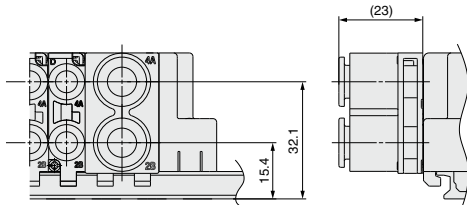

SJ

SY

SY

S0700

S0700

SJ2000/3000 Series Manifold Options 5

For Connector Type/Individual Wiring

■ Regulator block/How to Order

This is used to reduce the pressure supplied from the D side inside the manifold. All valves on the U side are depressurized from the regulator block.

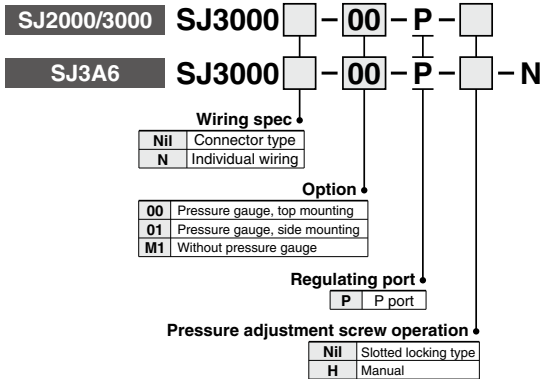

Note 1) Be sure to apply the pressure from the 1(P) port of the manifold before using the regulator block.

Note 2) When ordering with a regulator block installed in the manifold, please order using the manifold specification sheet.

SJ3000(N)-00-P-(H)

With manual operation of pressure adjustment screw

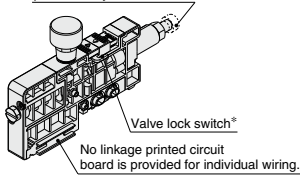

SJ3000(N)-01-P-(H)

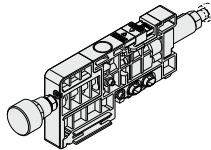

SJ3000(N)-M1-P-(H)

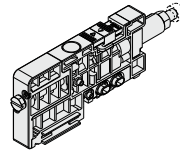

Pressure gauge, top mounting

* The valve lock switch available only for SJ2000/3000 series.

■ Flow Rate Characteristics (Conditions: Inlet pressure 0.7 MPa 2 position solenoid valve mounting)

SJ2000

P port regulation (P→A, B)

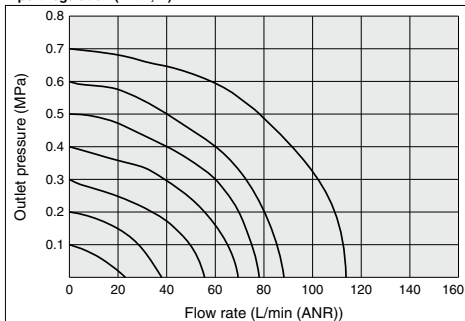

SJ3000

P port regulation (P→A, B)

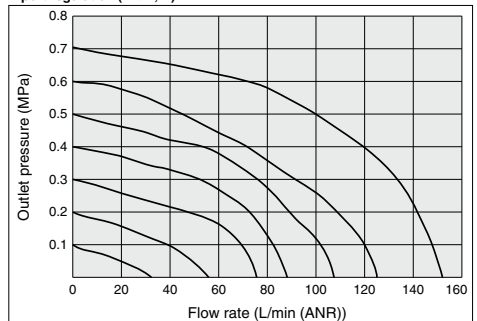

SJ2000/3000 Series Manifold Options 6

■ Pneumatic circuit (Regulator block mounting example)

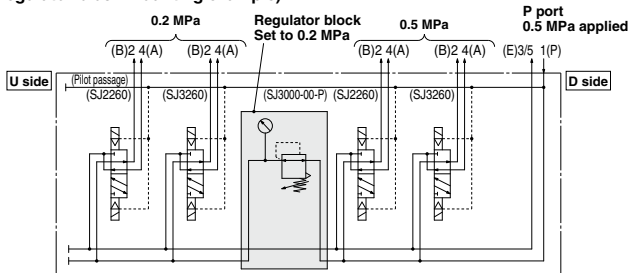

Note) Reduces supply pressure from the D side of manifold.
Supply pressure from the U side cannot be reduced.

■ Dimensions

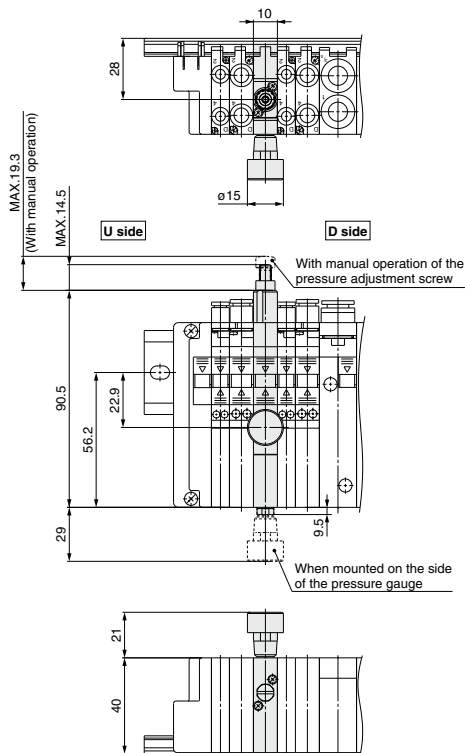

SJ

SY

SY

S0700

S0700

SJ2000/3000 Series Manifold Options 7

For Connector Type/Individual Wiring

■ SUP/EXH block assembly with regulator and pressure switch (for internal pilot manifold)/How to Order

* When mounting on the manifold, specify it in the manifold specification sheet.

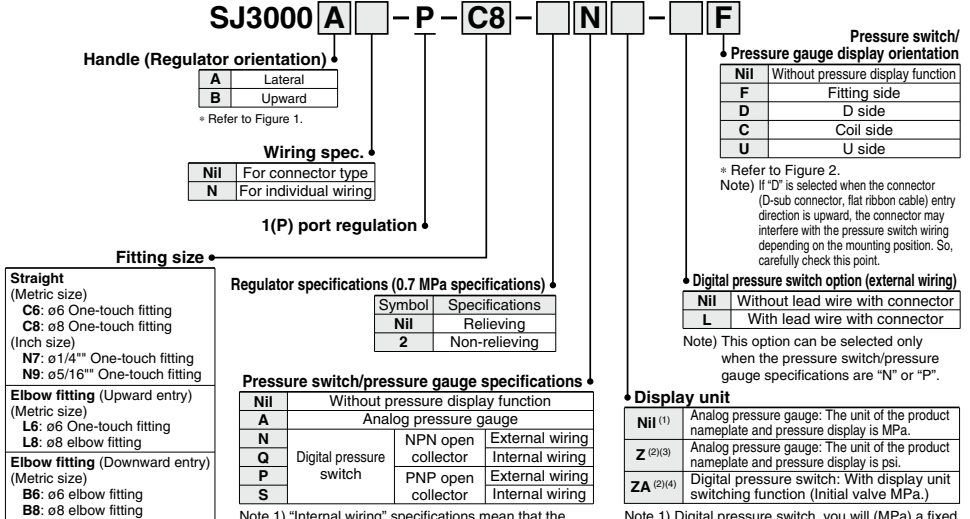

Note) When the handle orientation is lateral, the elbow fitting (upward entry) cannot be selected.

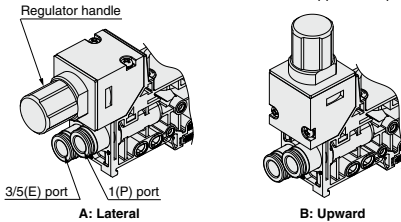
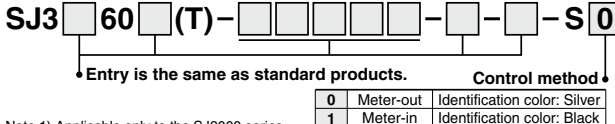

Fig.1 Handle orientation (Regulator mounting orientation)

- Note 1) Be sure to apply the pressure from the 1(P) port of the manifold before using the SUP/EXH block assembly with regulator and pressure switch.
- Note 2) For details on regulator and electric circuit of the external wiring specifications, see the catalog for the ARM11 series.
- Note 3) Applicable only to the manifolds with the internal pilot specifications.
- Note 4) This regulator block cannot be combined with the vacuum release valve of the SJ3A6 series.

■ SJ3000 Series Valve with Speed Controller/How to Order



- Note 1) Applicable only to the SJ3000 series.
- Note 2) Specify S0 or S1 at the end of the valve part no.
- Note 3) Set the operating torque of the speed controller to 0.3 N·m or less.

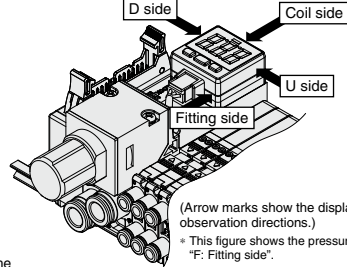
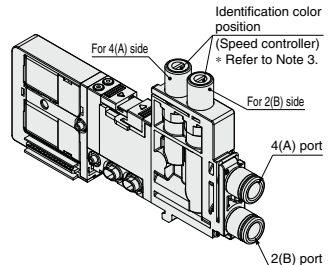

Fig.2 Pressure switch/pressure gauge display orientation symbol



SJ2000/3000 Series Manifold Options 8

Flow rate characteristics

Regulator unit flow rate characteristics

SJ2000 passage P→A/B

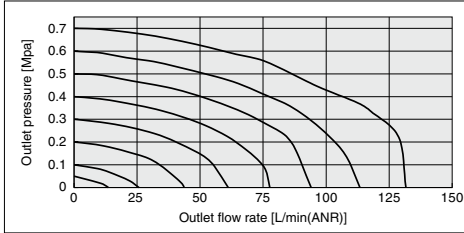

SJ3000 passage P→A/B

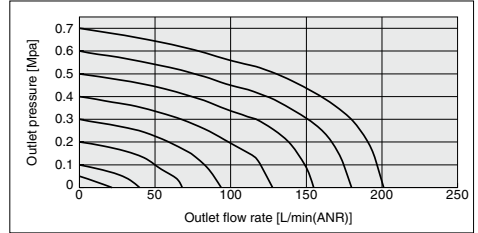

Valve with speed controller flow rate characteristics

Meter-out control A/B→E

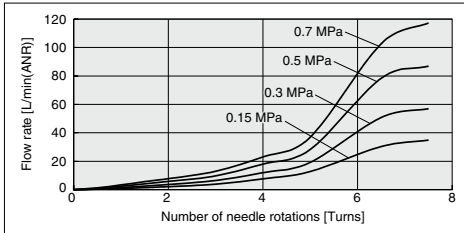

Meter-in control P→A/B

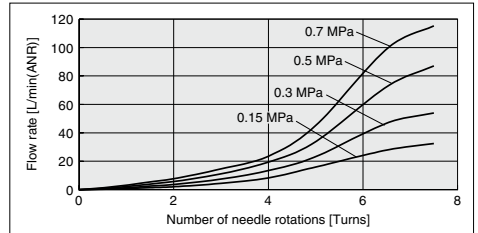

* The flow rate characteristics are characteristics of each individual product. Actual values may differ depending on the piping, circuitry, pressure conditions, etc. Also, depending on product specifications, there may be variations in the zero needle rotations position of the flow rate characteristics.

Pneumatic circuit

(Installation example of SUP/EXH block assembly with regulator and pressure switch, valve with speed controller)

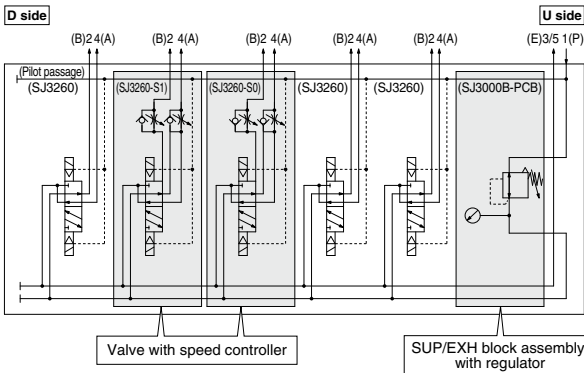

SJ

SY

SY

S0700

S0700

SJ2000/3000 Series Manifold Options 9

For Connector Type/Individual Wiring

■ SUP/EXH block assembly with regulator and pressure switch, valve with speed controller/Dimensions

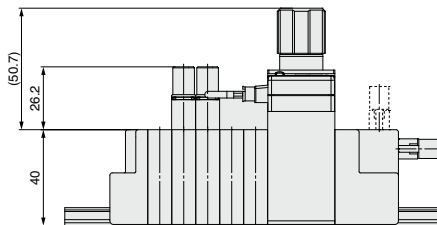
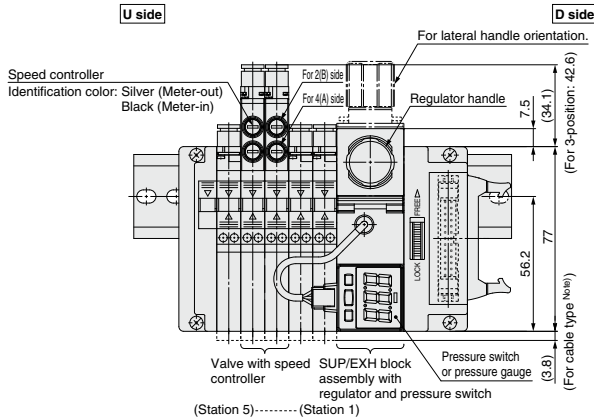
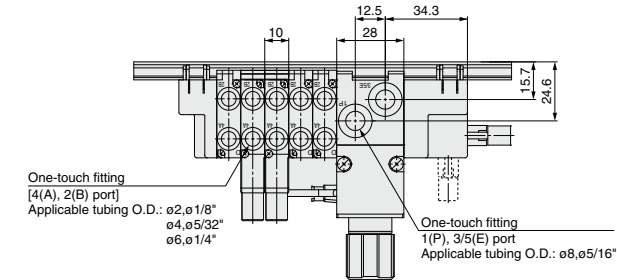

Note) The SUP/EXH block assembly with regulator and pressure switch cannot be mounted on the plug-in cable type manifold.

SJ2000/3000 Series Manifold Options 10

■ Manifold electrical wiring when the SUP/EXH block assembly with the regulator and pressure switch is mounted.
(Internal wiring and pressure switch (NPN))

D-sub connector (25 pins)

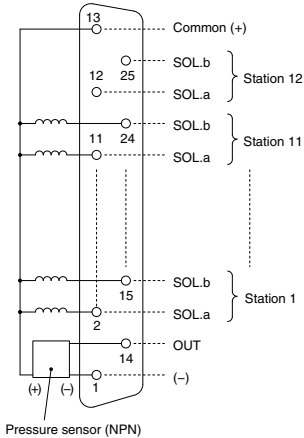

Pressure sensor (NPN)

Flat ribbon cable (26 pins)

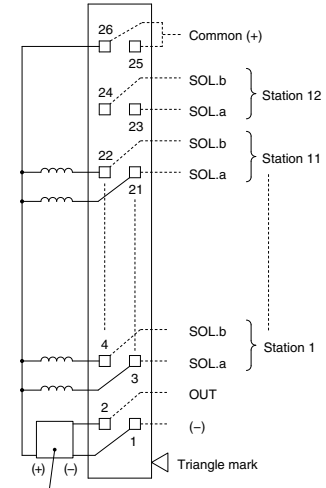

Pressure sensor (NPN)

Flat ribbon cable (20 pins)

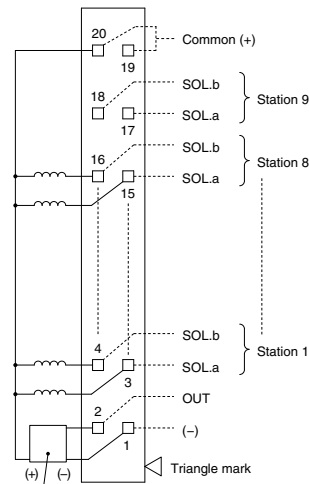

Pressure sensor (NPN)

Flat ribbon cable (10 pins)

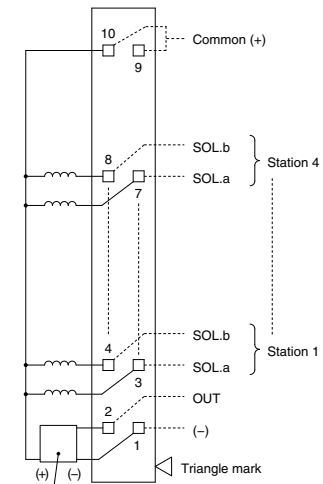

Pressure sensor (NPN)

Note 1) This figure shows when the SUP/EXH block assembly with the regulator and pressure switch is mounted between the connector block and 1st station valve.

Note 2) Applicable only to the connector type manifold.

SJ2000/3000 Series Manifold Options 11

For connector type

Intermediate connector block assembly

This connector block can be used by inserting it into the middle of the manifold.

This can be used, for example, when you wish to separate electrical control of valves in the same manifold, or when the number of control points is insufficient.

Series	Part no.	Note
SJ2000	SJ3000-76-1A	Flat ribbon cable (20 pins)
SJ3000	SJ3000-76-4A	Flat ribbon cable (26 pins)

Note) When ordering with an intermediate connector block assembly installed in the manifold, please order using the manifold specification sheet.

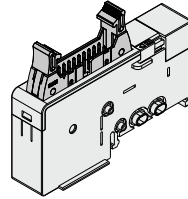

Intermediate connector block assembly wiring example

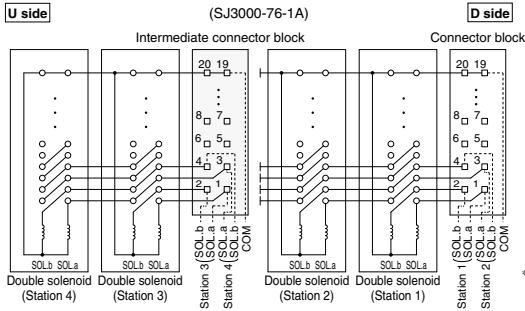

For flat ribbon cable (20 pins)

* Enables control of U side solenoid valves from the position where the intermediate connector block assembly is installed.

Dimensions

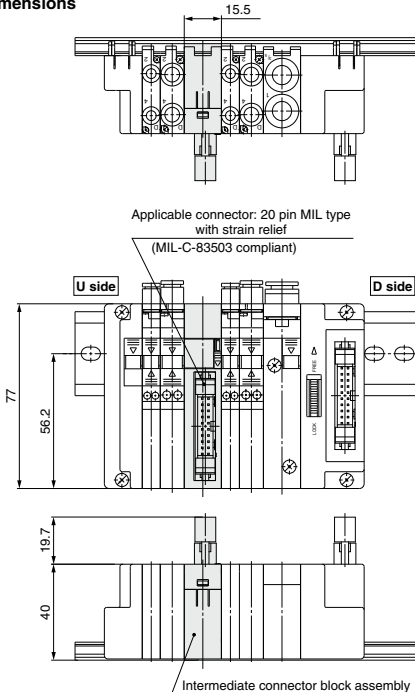

* This drawing shows the SJ3000-76-1A.

SJ2000/3000 Series

Made to Order

Please contact SMC for detailed dimensions, specifications and lead times.



1 Main Valve Fluororubber Specifications

Symbol
-X90

Fluororubber is used for rubber parts of the main valve to allow use in applications such as the following.

1. When using a lubricant other than the recommended turbine oil, and there is a possibility of malfunction due to swelling of the spool valve seals.
2. When ozone enters or is generated in the air supply.

Part no. SJ $\frac{2}{3}$ 60 (T) - - - -X90

• Entry is the same as standard products.

Note) Because in the -X90 series fluororubber is used for only main valve, the rubber parts of the application/usage in conditions requiring heat resistance should be avoided.

SJ

SY

SY

S0700

S0700

Vacuum Release Valve with Restrictor

SJ3A6 Series

SJ

SY

SY

S0700

S0700

Plug-in Type

P.104 Connector Connection

D-sub Connector
Flat Ribbon Cable
Serial Wiring: EX180
Serial Wiring: EX510

P.106 Cable Connection

D-sub Connector
Flat Ribbon Cable

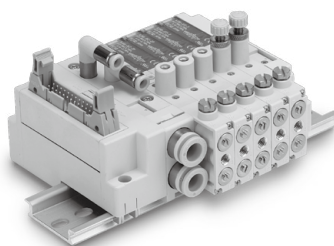
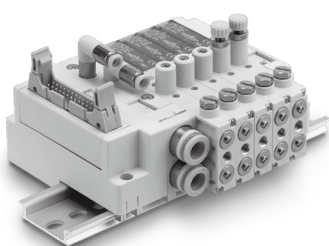

Non Plug-in Type Individual Wiring

P.110 Individual Wiring

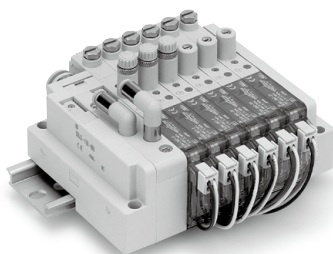

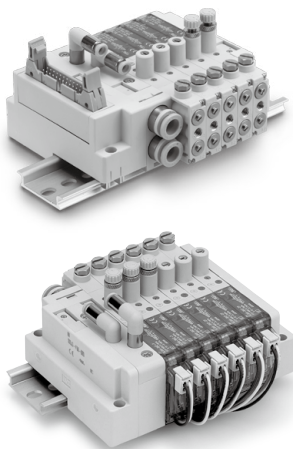

Manifold Valve Specifications

Valve construction		3 position 3 port valve with restrictor
Fluid		Air
Operating pressure range (MPa)	Release pressure port 1(P)	0.25 to 0.7
	Vacuum pressure port 3/5(E)	-100 kPa to 0.7 <i>Note 1)</i>
	Pilot X port	0.25 to 0.7 <i>Note 2)</i>
Ambient and fluid temperature (°C)		-10 to 50 (No freezing)
Max. operating frequency (Hz)		3
Manual override (Manual operation)		Non-locking push type
		Push-turn locking slotted type
Restrictor operation		Manual
		Slotted locking type
Pilot method		External pilot/Pilot valve individual exhaust
Lubrication		Not required
Mounting orientation		Unrestricted
Impact/Vibration resistance (m/s²) <i>Note 3)</i>		150/30
Enclosure		Dustproof

Note 1) Can be used with positive pressure to suit the application.

Note 2) Please use with pilot X port pressure equal to or higher than the release port 1(P) pressure.

Note 3) Impact resistance: No malfunction occurred when it is tested in the axial direction and at the right angles to the main valve and armature in both energized and de-energized states every once for each condition. (Values at the initial period)

Vibration resistance: No malfunction occurred in a one-sweep test between 45 and 2000 Hz. Test was performed at both energized and de-energized states in the axial direction and at the right angles to the main valve and armature. (Values at the initial period)

Symbol

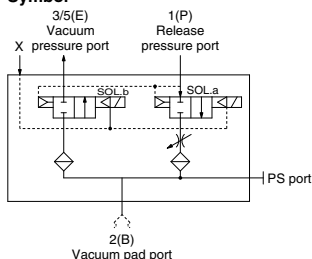

Solenoid Specifications

Coil rated voltage		24 VDC, 12 VDC
Allowable voltage fluctuation		±10% of rated voltage *
Power consumption (W)	Standard	0.4
	With power saving circuit (Continuous duty type)	0.15 * [Starting 0.4, Holding 0.15]
Surge voltage suppressor		Diode
Indicator type		LED

* For the allowable voltage fluctuation for Z/T type (with power saving circuit), please observe the following range because they have voltage drop due to internal circuit.

Z type 24 VDC: -7% to +10%

12 VDC: -4% to +10%

T type 24 VDC: -5% to +10%

12 VDC: -6% to +10%

Note) Refer to page 117 for details.

Response Time

Valve model	Response time ms (at 0.5 MPa)
SJ3A6-□□-□	19 or less

Weight

Valve model	Weight (g)
SJ3A6-□□-P	79

Flow Rate Characteristics

Flow Rate Characteristics (When restrictor is fully open)

Valve model	1(P)→2(B)			2(B)→3/5(E)			
	Fluid passage 2(B) Port size	C[dm ³ /(s·bar)]	b	Cv	C[dm ³ /(s·bar)]	b	Cv
SJ3A6-□□-□	M5	0.24	0.19	0.05	0.40	0.18	0.10

Restrictor Flow Rate Characteristics [Fluid passage: 1(P)→2(B)]

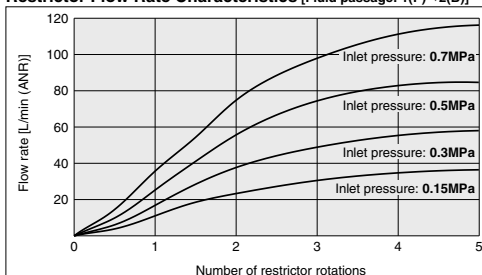

Construction/Circuit Example

Construction

Connector type

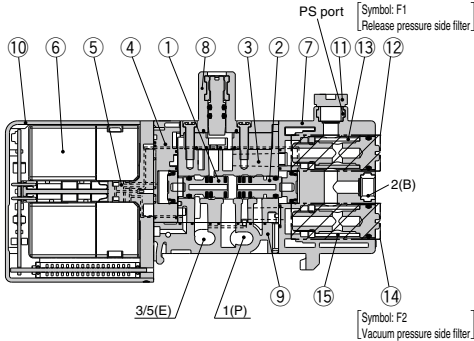

Cable type

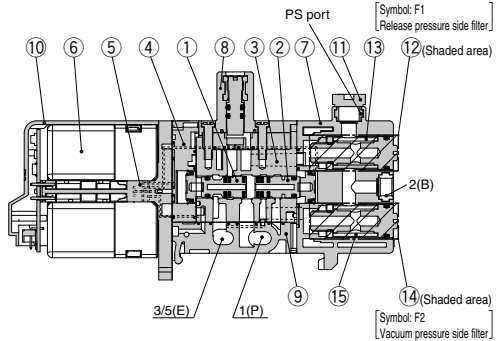

SJ
SY
SY
S0700
S0700

Component Parts

No.	Description	Material	Note
1	Spool valve assembly	Resin/HNBR	A side (for release pressure switching)
2	Spool valve assembly	Resin/HNBR	B side (for vacuum pressure switching)
3	Body	Zinc die-cast	—
4	Adapter plate	Resin	White
5	Pilot adapter	Resin	White
6	Pilot valve assembly	—	—
7	End cover	Resin	White
8	Restrictor block assembly ^{Note)}	Resin	White
9	Bottom cover	Resin	White
10	Light cover	Resin	Light blue

Note) Set the operating torque of the restrictor of the restrictor block assembly to 0.3 N·m or less.

Component Parts

No.	Description	Part no.	Note
11	Plug	M-5P	PS port with plug
12	Filter assembly	SJ3000-110-1A	1 μm White <Release pressure side>
13	Filter	SJ3000-107-1A	1 μm White <Release pressure side>, 5 pcs. included
14	Filter assembly	SJ3000-110-2A	30 μm Light purple <Vacuum pressure side>
15	Filter	SJ3000-107-2A	30 μm Light purple <Vacuum pressure side>, 5 pcs. included

<Filter replacement instructions>

If there are situations such as filter clogging, a drop in suction force, or slow response time, stop operation and replace the filter.

- Using a precision driver, remove the filter assembly (12 or 14) from the main unit.
- Turn the filter guide by hand and remove.
- Replace the filter (13 or 15) and gently hand tighten the filter guide. At this time, check that there is no foreign matter on the O-ring of the filter assembly.
- Return the filter assembly to the main unit. (Tightening torque: 0.12 N·m)

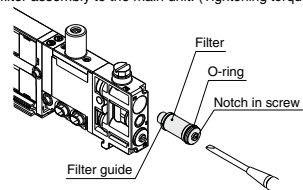

After tightening the plug (M-5P) with a tightening torque of 1 N·m, or manually tightening, use the tightening tool and tighten it by 1/4 turn.

12/14 Filter assembly (with filter)

13/15 Filter (5 pcs. included)

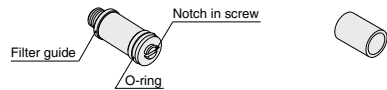

Adsorbing and Transferring System Circuit Example

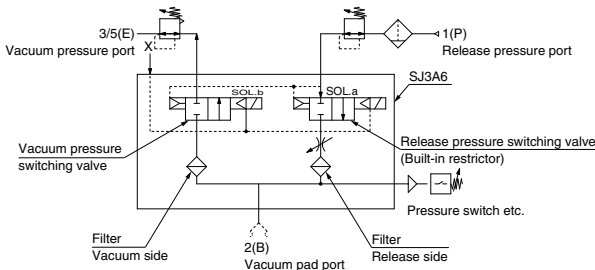

Vacuum Release Valve with Restrictor

SJ3A6 Series

An order cannot be placed with only the manifold part no. Be sure to order solenoid valves for mounting at the same time while referring to the ordering example.

How to Order

● Vacuum release valve manifold with restrictor

SS3J3-V 60 [] [] - **05** **U** [] []

Vacuum release valve with restrictor type ●

Connector type ●

Symbol	Mounting position	Page	Note
FD	D-sub connector	P.34	Parallel wiring
PD	Flat ribbon cable 26 pins		
PGD	Flat ribbon cable 20 pins		
PHD	Flat ribbon cable 10 pins	P.60	Serial wiring
S	EX180 serial transmission		
S6B	EX510 serial transmission		

Connector entry ●

With parallel wiring specifications, it is necessary to select the connector entry direction (1: upward, 2: lateral). For details, refer to pages 34 and 52.

DIN rail length specified

Nil	Standard length
2	2 stations
⋮	⋮
16	16 stations

Specify a longer rail than the standard length.

* Specify the valve stations not exceeding the maximum stations.

SUP/EXH block mounting position

U	U side (1 to 10 stations)
D	D side (1 to 10 stations)
B	Both sides (1 to 16 stations)
M*	Special specifications

* Specify the required specifications (Including port sizes other than ø8) by means of the manifold specification sheet.

SUP/EXH block fitting spec.

Nil	Straight fitting	
L	Elbow fitting (Upward)	
B	Elbow fitting (Downward)	

* There is no need to enter anything when the SUP/EXH block mounting position "M" is selected. Also, this manifold comes standard with external pilot specifications.

How to Order Manifold Assembly

Ordering example (SS3J3-V60PD2-□)

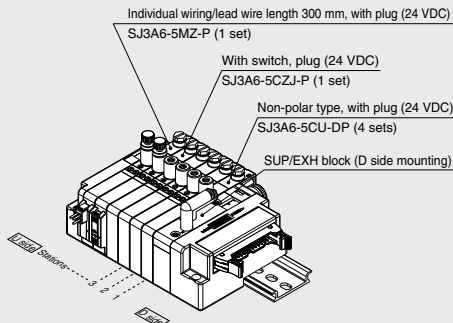

Symbol	Stations	Note
SS3J3-V60PD2-06D	1	1 set (Manifold part no.)
SJ3A6-5CU-DP	4	4 sets (Non-polar type, with plug part no.)
SJ3A6-5CZJ-P	1	1 set (With switch, plug part no.)
SJ3A6-5MZ-P	1	1 set (Individual wiring, lead wire length 300 mm, with plug part no.)

The asterisk denotes the symbol for assembly. Prefix to the part no. of the solenoid valve, etc.

* The valve arrangement is numbered as the 1st station from D side.
 * Indicate the valves to be attached below the manifold part number. In order starting from station 1 as shown in the drawing. In the case of complex arrangement, specify them in the manifold specification sheet.
 (Note) When ordering a manifold, specify the part nos. of valves to be mounted together. (An order cannot be placed with only the manifold part no.)

● Valve stations

F: D-sub connector

Symbol	Stations
01	1 station
⋮	⋮
12	12 stations

P: Flat ribbon cable (26 pins)

Symbol	Stations
01	1 station
⋮	⋮
12	12 stations

PG: Flat ribbon cable (20 pins)

Symbol	Stations
01	1 station
⋮	⋮
09	9 stations

PH: Flat ribbon cable (10 pins)

Symbol	Stations
01	1 station
⋮	⋮
04	4 stations

S6B: EX510 serial transmission

Symbol	Stations
01	1 station
⋮	⋮
08	8 stations

S□: EX180 serial transmission

Symbol	Stations	Note
01	1 station	There are limitations on the station number, depending on the serial type.
⋮	⋮	
16	16 stations	Refer to page 60 for details.

* The number of the blanking block assembly is also included. For the blanking block assembly, please select double wiring specifications.

How to Order Solenoid Valves (3 Position 3 Port with Restrictor)

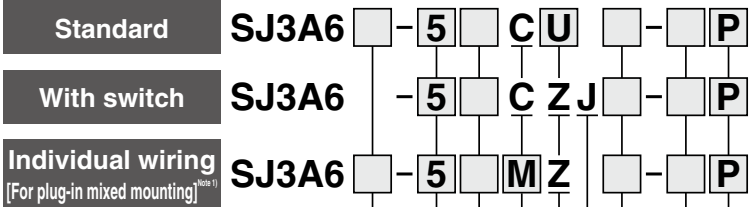

Note 1) Refer to pages 110 and 111 for the dedicated non plug-in individual wiring.

Coil spec.

Nil	Standard
T	With power saving circuit (Continuous duty type)

* Be sure to select "with power saving circuit" when the solenoid valve will be energized continuously for long period.

Rated voltage

5	24 VDC
6	12 VDC

* Only 24 VDC is available for manifolds compatible with serial wiring.

Common specifications

Nil	Positive common
N	Negative common

* For the non-polar type, there is no need to select a symbol.
 * When the manifold applicable to the serial transmission system and the valve with the standard type switch are used, select common specifications suitable for the SI unit common specifications.

Connector entry

C: Dedicated for centralized wiring

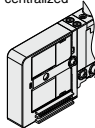

M: Individual wiring, With lead wire
Length 300 mm

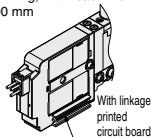

MN: Individual wiring, Without lead wire (With connector, socket)

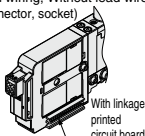

MO: Individual wiring, Without connector

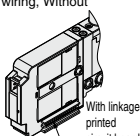

Light/surge voltage suppressor

U	With light/surge voltage suppressor (Non-polar type)
Z	With light/surge voltage suppressor (Polar type)

* When the types with power saving circuit, with switches, and/or individual wiring are used, the non-polar type cannot be selected.

With switch

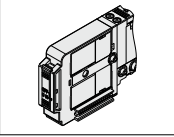

PS port for detection

Nil: M5 x 0.8



Needle operation

Nil: Manual



D: Slotted locking type



P: With plug (M-5P)



* Set operation torque to 0.3 N·m or less.

* When mounting a pressure sensor etc., select "Nil."

Manual override

Nil: Non-locking push type

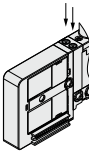

D: Push-turn locking slotted type

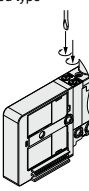

* No slide locking type manual override setting is provided.

Note 2) There is no valve block switch for linking the neighboring valve, etc. to the 3 position 3 port solenoid valve with restrictor. Consult SMC if you wish to use the SJ2000/3000 valve with a valve block switch, or an end block or SUP/EXH block assembly.

* Connector entries with the symbol "M□" can not use the switch signal from the common wiring on the manifold.
 * When ordering a connector assembly separately, refer to pages 120 and 121.

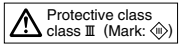

Plug-in Cable Type



Vacuum Release Valve with Restrictor

SJ3A6 Series

An order cannot be placed with only the manifold part no. Be sure to order solenoid valves for mounting at the same time while referring to the ordering example.

How to Order

● Vacuum release valve manifold with restrictor

SS3J3-V60L **D** - **05** **U**

Vacuum release valve with restrictor type

Cable type

Connector type

Symbol	Mounting position	Page	Note
F	D-sub connector	P.36	Parallel wiring
P	Flat ribbon cable 26 pins		
PG	Flat ribbon cable 20 pins		
PH	Flat ribbon cable 10 pins		

Connector mounting position

Symbol	Mounting position
D	D side

Connector entry

With parallel wiring specifications, it is necessary to select the connector entry direction (1: upward, 2: lateral). For details, refer to page 36.

DIN rail length specified

Nil	Standard length
3	3 stations Specify a longer rail than the
10	10 stations standard length.

When specifying a rail longer than the standard length, select the valve stations not exceeding the maximum stations.

SUP/EXH block fitting spec.

Nil	Straight fitting
L	Elbow fitting (Upward)
B	Elbow fitting (Downward)

There is no need to enter anything when the SUP/EXH block mounting position "M" is selected. Also, this manifold comes standard with external pilot specifications.

SUP/EXH block mounting position

U	U side (2 to 10 stations)
D	D side (2 to 10 stations)
B	Both sides (2 to 10 stations)
M*	Special specifications

For the special specifications, a port size of the SUP/EXH block assembly can be specified. At this time, the mounting position becomes only U, D, or B.

How to Order Valve Manifold Assembly

Ordering example (SS3J3-V60LPD2-□)

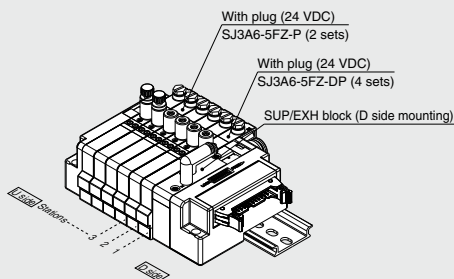

SS3J3-V60LPD2-06D ... 1 set (Manifold part no.)
 * **SJ3A6-5FZ-DP** 4 sets (With plug part no.)
 * **SJ3A6-5FZ-P** 2 sets (With plug part no.)

The asterisk denotes the symbol for assembly. Prefix to the part no. of the solenoid valve, etc.

The valve arrangement is numbered as the 1st station from D side.
 Indicate the valves to be attached below the manifold part number, in order starting from station 1 as shown in the drawing. In the case of complex arrangement, specify them in the manifold specification sheet.

Valve stations

F: D-sub connector

Symbol	Stations
02	2 stations
...	...
10	10 stations

P: Flat ribbon cable (26 pins)

Symbol	Stations
02	2 stations
...	...
10	10 stations

PG: Flat ribbon cable (20 pins)

Symbol	Stations
02	2 stations
...	...
09	9 stations

PH: Flat ribbon cable (10 pins)

Symbol	Stations
02	2 stations
...	...
04	4 stations

The number of the blanking block assembly is also included.
 The cable type is applicable to 2 or more stations.

How to Order Solenoid Valves (3 Position 3 Port with Restrictor)

SJ3A6 - **5** **FZ** - **P**

Coil spec.

Nil	Standard
T	With power saving circuit (Continuous duty type)

* Be sure to select "with power saving circuit" when the solenoid valve will be energized continuously for long period.

Rated voltage

5	24 VDC
6	12 VDC

Common specifications

Nil	Positive common
N	Negative common

Connector entry

F: Dedicated for centralized wiring Cable type

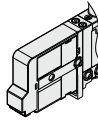

Light/surge voltage suppressor

Z With light/surge voltage suppressor

Manual override

Nil: Non-locking push type

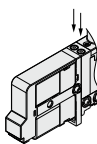

D: Push-turn locking slotted type

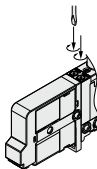

* No slide locking type manual override setting is provided.

PS port for detection

Nil: M5 x 0.8



P: With plug (M-5P)



* When mounting a pressure sensor etc., select "Nil."

Needle operation

Nil: Manual



D: Slotted locking type



* Set operation torque to 0.3 N·m or less.

SJ

SY

SY

S0700

S0700

(Note) There is no valve block switch for the 3 position 3 port solenoid valve with restrictor.

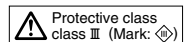

SJ3A6 Series

Dimensions

SS3J3-V60 $\frac{P \cdot D}{FD}$ $\frac{1}{2}$ - Stations U/D/B

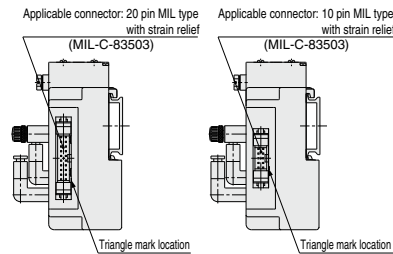
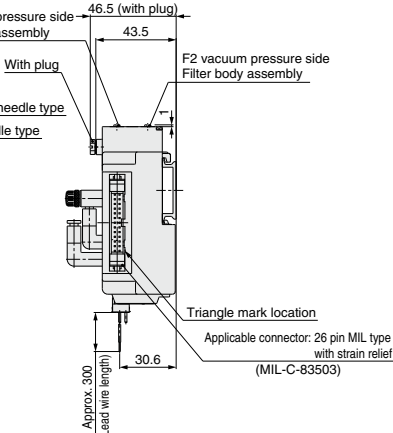
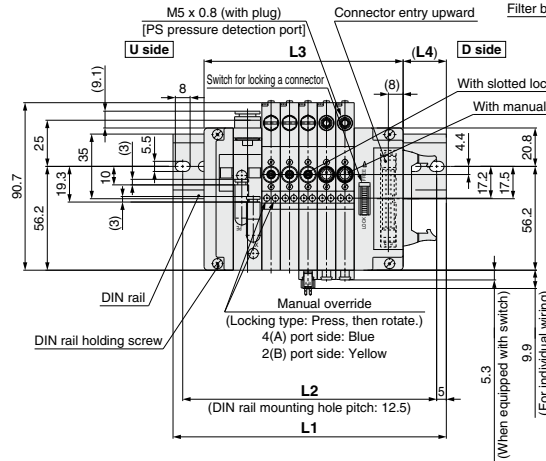
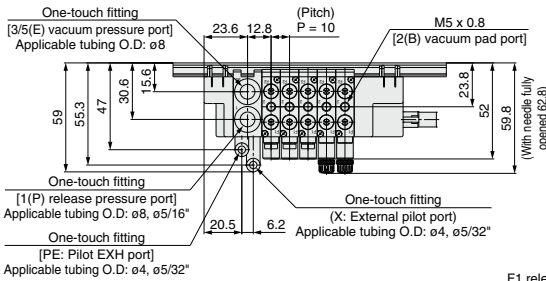

In case of 60PG (20 pins) In case of 60PH (10 pins)

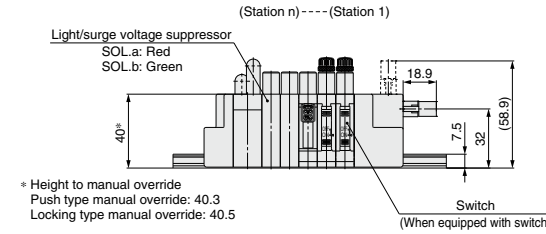

Since DIN rail dimensions are the same as the SS5J3-60□ series, refer to the following pages.
For D-sub connector: Page 42, 43
For flat ribbon cable: Page 47, 48
For EX180 serial wiring: Page 64, 65
For EX510 serial wiring: Page 72, 73

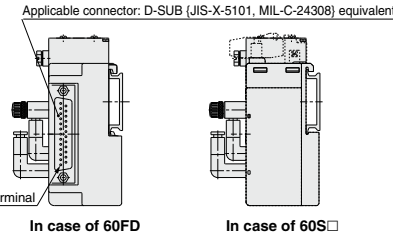
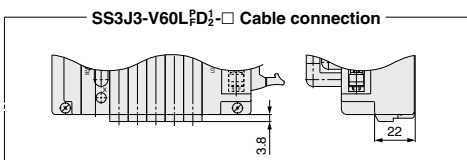

SJ

SY

SY

S0700

S0700

Non plug-in Individual Wiring



Vacuum Release Valve with Restrictor

SJ3A6 Series

An order cannot be placed with only the manifold part no. Be sure to order solenoid valves for mounting at the same time while referring to the ordering example.

How to Order

Individual wiring manifold

SS3J3-V 60-05 U

Vacuum release valve with restrictor type

Valve stations

Symbol	Stations
01	1 station
⋮	⋮
20	20 stations

* The number of the blanking block assembly is also included.

SUP/EXH block mounting position

U	U side (1 to 10 stations)
D	D side (1 to 10 stations)
B	Both sides (1 to 20 stations)
M*	Special specifications

* Specify the required specifications (including port sizes other than ø8) by means of the manifold specification sheet.

DIN rail length specified

Nil	Standard length
2	2 stations
⋮	⋮
20	20 stations

* Specify the valve stations not exceeding the maximum stations.

SUP/EXH block fitting spec.

Nil	Straight fitting	
L	Elbow fitting (Upward)	
B	Elbow fitting (Downward)	

* There is no need to enter anything when the SUP/EXH block mounting position "M" is selected. Also, this manifold comes standard with external pilot specifications.

How to Order Manifold Assembly

Ordering example (SS3J3-V60-□)

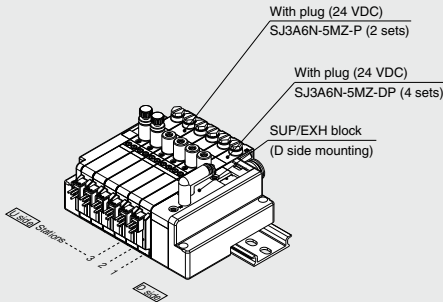

- SS3J3-V60-06D 1 set (Manifold part no.)
- * SJ3A6N-5MZ-DP 4 sets (With plug part no.)
- * SJ3A6N-5MZ-P 2 sets (With plug part no.)

The asterisk denotes the symbol for assembly. Prefix to the part no. of the solenoid valve, etc.

- * The valve arrangement is numbered as the 1st station from D side.
- * Indicate the valves to be attached below the manifold part number, in order starting from station 1 as shown in the drawing. In the case of complex arrangement, specify them in the manifold specification sheet.

How to Order Solenoid Valves (3 Position 3 Port with Restrictor)

SJ3A6 **N** - **5** **MZ** - **P**

Coil spec.

Nil	Standard
T	With power saving circuit (Continuous duty type)

* Be sure to select "with power saving circuit" when the solenoid valve will be energized continuously for long period.

For non plug-in only

Rated voltage

5	24 VDC
6	12 VDC

Common specifications

Nil	Positive common
N	Negative common

Connector entry

M: Individual wiring, With lead wire
Length 300 mm

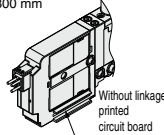

MN: Individual wiring, Without lead wire
(With connector, socket)

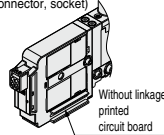

MO: Individual wiring, Without connector

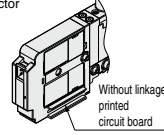

* When ordering a connector assembly separately, refer to pages 120 and 121.

With light/surge voltage suppressor

PS port for detection

Nil: M5 x 0.8



P: With plug (M-5P)



* When mounting a pressure sensor etc., select "Nil."

Needle operation

Nil: Manual



D: Slotted locking type



* Set operation torque to 0.3 N·m or less.

Manual override

Nil: Non-locking push type

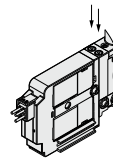

D: Push-turn locking slotted type

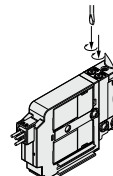

* No slide locking type manual override setting is provided.

SJ
SY
SY
S0700
S0700

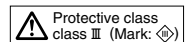

SJ3A6 Series

Dimensions

SS3J3-V60-Stations U/D/B

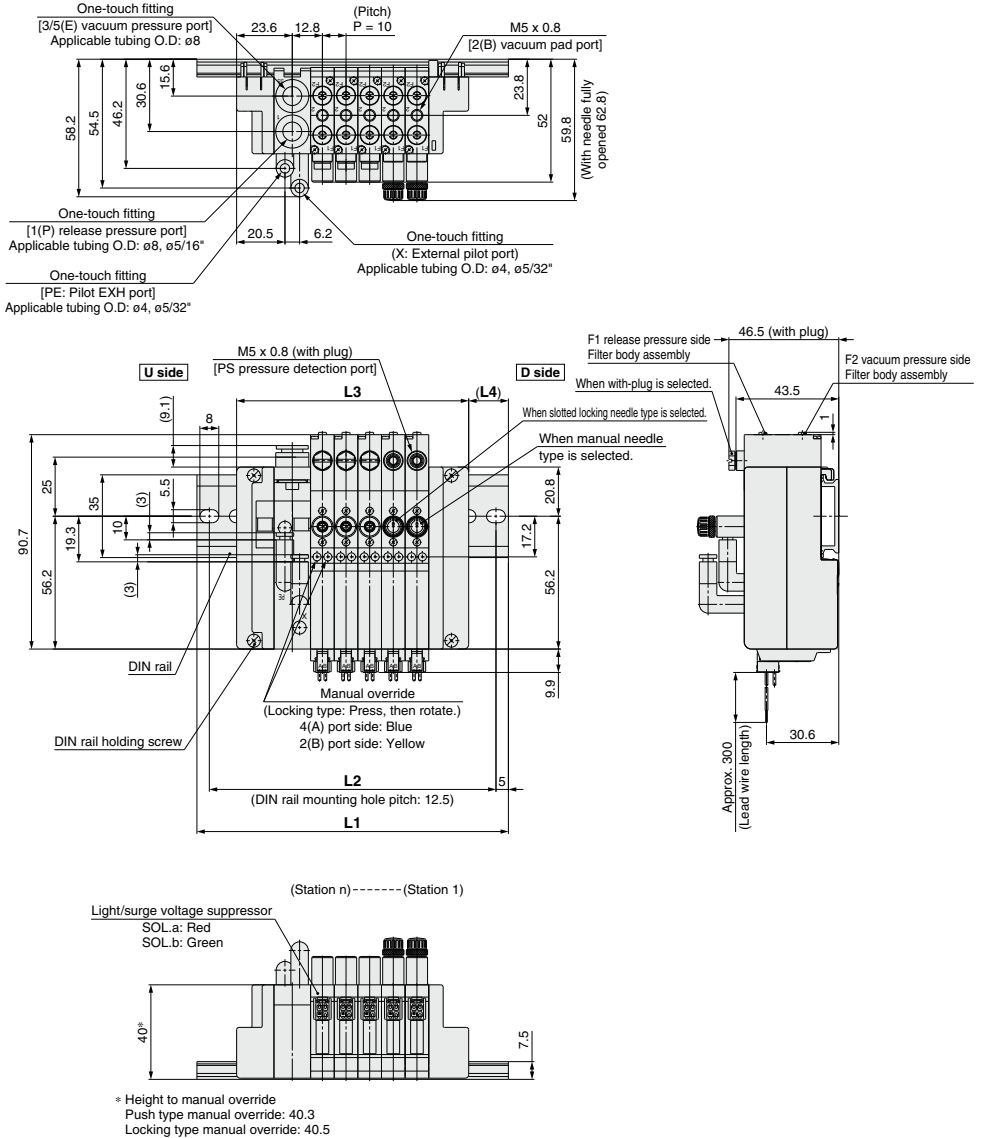

Since DIN rail dimensions are the same as the SS5J3-60-□ series, refer to pages 84 and 85.

SJ3A6 Series

Manifold Exploded View 1

Connector Type/Individual Wiring

Type V60P (Vacuum release valve with restrictor) manifold

(Note) Refer to page 77 for "How to Increase Manifold Stations."

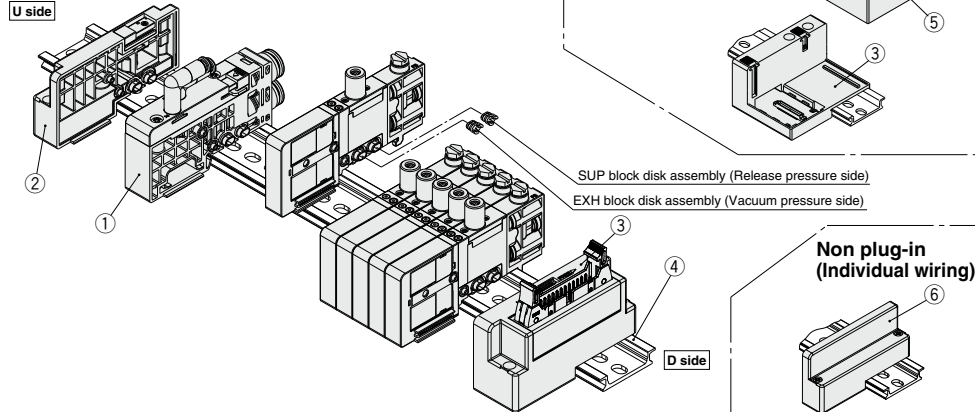

Component Parts/Plug-in

No.	Description	Part no.	Note
1 (Note 1)	SUP/EXH block assembly	External pilot specification (X, PE port: Metric size $\phi 4$ Inch size $\phi 5/32$)	SJ3000-50-1AR-□□-N (Metric size) C6: With $\phi 6$ One-touch fitting (straight) C8: With $\phi 8$ One-touch fitting (straight) L6: With $\phi 6$ One-touch fitting (elbow upward entry) L8: With $\phi 8$ One-touch fitting (elbow upward entry) B6: With $\phi 6$ One-touch fitting (elbow downward entry) B8: With $\phi 8$ One-touch fitting (elbow downward entry)
		For different pressures (Note 2)	SJ3000-50-3A-□□-N (Inch size) N7: With 1/4" One-touch fitting (straight) N9: With 5/16" One-touch fitting (straight)
2 (Note 1)	End block assembly	SJ3000-53-1A-N	For U side
3	Connector block assembly	SJ3000-42-□A-□	Refer to the connector block assembly part no. shown below.
4	DIN rail	VZ1000-11-1-□	Refer to page 90.
5	SI unit	EX180-□□	Refer to the SI unit part numbers on page 60.

Connector Block Assembly Part No.

Connector specifications	Mounting position	Part no.	Note
For D-sub connector (Locking bracket: Metric size thread)	D side	SJ3000-42-1A-□	□: 1 (Connector upward) □: 2 (Connector lateral)
For D-sub connector (Locking bracket: Unified thread)		SJ3000-42-1AU-□	
For flat ribbon cable 26 pins		SJ3000-42-2A-□	
For flat ribbon cable 20 pins		SJ3000-42-3A-□	
For flat ribbon cable 10 pins		SJ3000-42-4A-□	
For EX180 serial wiring (Note)		SJ3000-42-20A	
For EX510 serial wiring (Note)		SJ3000-42-3A-2	

(Note) SI unit is not included.

Component Parts/Non plug-in (Individual Wiring)

No.	Description	Part no.	Note
1 (Note 1)	SUP/EXH block assembly	External pilot specification (X, PE port: Metric size $\phi 4$ Inch size $\phi 5/32$)	SJ3000-50-5AR-□□-N (Metric size) C6: With $\phi 6$ One-touch fitting (straight) C8: With $\phi 8$ One-touch fitting (straight) L6: With $\phi 6$ One-touch fitting (elbow upward entry) L8: With $\phi 8$ One-touch fitting (elbow upward entry) B6: With $\phi 6$ One-touch fitting (elbow downward entry) B8: With $\phi 8$ One-touch fitting (elbow downward entry)
		For different pressures (Note 2)	SJ3000-50-6A-□□-N (Inch size) N7: With 1/4" One-touch fitting (straight) N9: With 5/16" One-touch fitting (straight)
2 (Note 1)	End block assembly	SJ3000-53-1A-N	For U side
4	DIN rail	VZ1000-11-1-□	Refer to page 90.
6	End block assembly	SJ3000-53-2A	For D side

Note 1) For the SJ3A6 series, valve block and manual switches are not available.

Note 2) The valves cannot be operated only with the SUP/EXH block assembly for different pressure, select in combination with the SUP/EXH block assembly for external pilot.

Note 3) Refer to page 88 about the SUP/EXH block disk assembly and method of handling of parts at different pressure.

SJ

SY

SY

S0700

S0700

SJ3A6 Series

Manifold Exploded View 2

Cable Type

Type V60LP (Vacuum release valve with restrictor) manifold

(Note) Refer to page 78 for "How to Increase Manifold Stations."

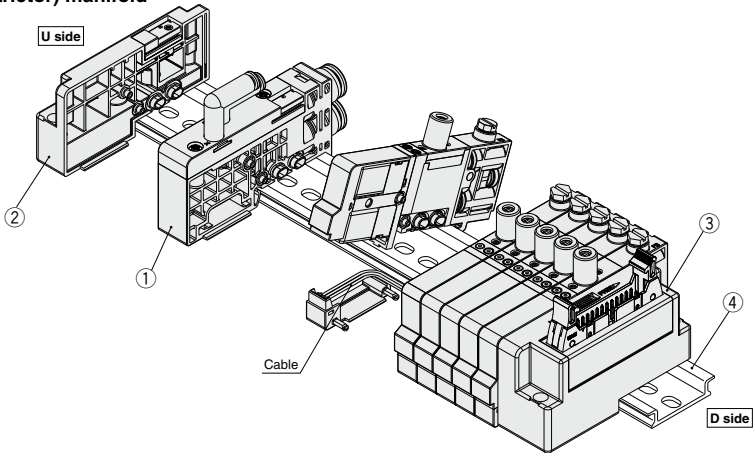

Component Parts/Plug-in (Cable Type)

No.	Description	Part no.	Note
1 ^{Note 1)}	External pilot specification	SJ3000-50-5AR-□□-N (X, PE port: Metric size ø4 Inch size ø5/32*)	(Metric size) C6: With ø6 One-touch fitting (straight) C8: With ø8 One-touch fitting (straight) L6: With ø6 One-touch fitting (elbow upward entry) L8: With ø8 One-touch fitting (elbow upward entry) B6: With ø6 One-touch fitting (elbow downward entry) B8: With ø8 One-touch fitting (elbow downward entry)
	For different pressures ^{Note 2)}	SJ3000-50-6A-□□-N	(Inch size) N7: 1/4" One-touch fitting (straight) N9: 5/16" One-touch fitting (straight)
2 ^{Note 1)}	End block assembly	SJ3000-53-1A-N	
3	Connector block assembly	SJ3000-42-□A-□	Refer to the connector block assembly part no. shown below.
4	DIN rail	VZ1000-11-1-□	Refer to page 90.

Note 1) For the SJ3A6 series, valve block and manual switches are not available.

Note 2) The valves cannot be operated only with the SUP/EXH block assembly for different pressure, select in combination with the SUP/EXH block assembly for external pilot.

Note 3) Refer to page 88 about the SUP/EXH block disk assembly and method of handling of parts at different pressure.

●Connector Block Assembly

SJ3000-42-□A-□-□-05

Connector type

7	D-sub connector
8	Flat ribbon cable 26 pins
9	Flat ribbon cable 20 pins
10	Flat ribbon cable 10 pins

* All connector block assembly mounting positions become the D side.

* The connector block assembly includes the cables necessary for the number of stations.

Valve stations

02 to 10	D-sub connector
02 to 10	Flat ribbon cable 26 pins
02 to 09	Flat ribbon cable 20 pins
02 to 04	Flat ribbon cable 10 pins

Connector entry

1	Connector upward
2	Connector lateral

Locking bracket

Nil	Metric size thread
U	Unified thread

* D-sub connector only.

SJ2000/3000 Series

Specific Product Precautions 1

Be sure to read this before handling the products.

Refer to back page 50 for Safety Instructions and pages 3 to 9 for 3/4/5 Port Solenoid Valve Precautions.



Manual Override Switch Operation

Warning

For manual override operation, move the manual override switch to a position where letters A and B can be seen. [Manual override switch release status (refer to the figure below)] Operation with the manual override switch in a locked status can cause damage to the manual override and air leakage, so be sure to release the manual override switch before use. After manual override operation, lock the manual switch for use (when the manual override of the push-turn locking slotted type is locked, a manual override switch cannot be locked).



Manual override switch locked status



Manual override switch unlocked status

Manual override switch slide direction

Manual Override Operation

Warning

When the manual override is operated, connected equipment will be actuated. Confirm safety before operating.

Non-locking push type

Press in the direction of the arrow.

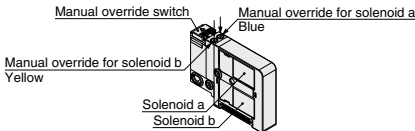

Push-turn locking slotted type

While pressing, turn in the direction of the arrow (90° clockwise). If it is not turned, it can be used in the same way as the non-locking push type.

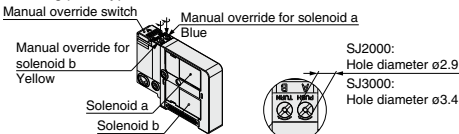

Slide locking type (manual override)

Slide the manual override all the way to the ON side in the arrow direction. The manual override is then locked. To unlock the manual override, slide it toward the OFF side in the arrow direction.

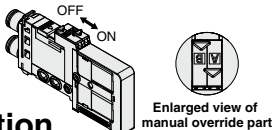

Caution

When you operate the D type with a screw driver, turn it gently using a watchmaker's screw driver. [Torque: under 0.05 N·m] When you lock the manual override of the D type, be sure to push it before turning. [Load: 10 N or less] Turning without pushing can cause damage to the manual override and trouble such as air leakage, etc.

Valve with Switch

Warning

When turning OFF the valve using the switch, move it to the position where the valve is locked. If the switch is at an improper position and is energized, equipment connected to the valve could be actuated.

Also, if the switch is turned OFF on the valve in the energized state, be careful because any actuators connected to a single solenoid, a dual 3 port valve or a 3 position valve will actuate.

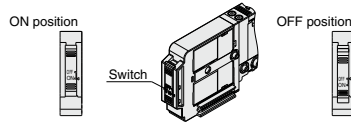

Normal operation: The valve is switched according to electric signals from the connector on the manifold side.

The valve coil is kept in a deenergized state even when there is an electric signal from the connector on the manifold side.

Electric circuit diagram

(with positive common and light/surge voltage suppressor)

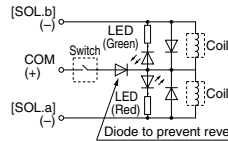

(with negative common and light/surge voltage suppressor)

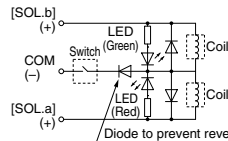

Built-in Back Pressure Check Valve Type

Caution

1. Valves with built-in back pressure check valve is to protect the back pressure inside a valve. For this reason, use caution the valves with external pilot specification cannot be pressurized from exhaust port [3/5(E)].

As compared with the types which do not integrate the back pressure check valve, C value of the flow rate characteristics (sonic conductance) goes down. For details, please contact SMC.
2. Do not switch valves when A or B port is open to the atmosphere, or while the actuators and air operated equipment are in operation. The back pressure prevention seal may be peeled off, which may cause air leakage or malfunctions. Use caution especially when performing a trial operation or maintenance work.

Exhaust Restriction

Caution

Since the SJ series is a type in which the pilot valve exhaust joins the main valve exhaust inside the valve, use caution, so that the piping from the exhaust port is not restricted.

SJ2000/3000 Series

Specific Product Precautions 2



Be sure to read this before handling the products.

Refer to back page 50 for Safety Instructions and pages 3 to 9 for 3/4/5 Port Solenoid Valve Precautions.

When Using a 4 Port Valve as a 3 Port Valve

Caution

When using a 4 port valve as a 3 port valve

The SJ2000/3000 series can be used as normally closed (N.C.) or normally open (N.O.) 3 port valves by plugging one of the cylinder ports 4(A) or 2(B). However, exhaust ports should be left open. It is convenient when a double solenoid 3 port valve is required.

Plug position	2(B) port	4(A) port
Type of actuation	N.C.	N.O.
Number of solenoids	Single 	(A)4 2(B)
	Double 	(A)4 2(B)

Light/Surge Voltage Suppressor

Caution

Non-polar type

Single solenoid

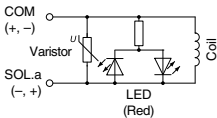

Double solenoid, 3 position type

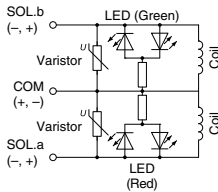

Positive common

Single solenoid

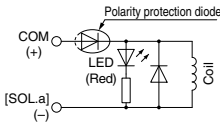

Double solenoid, 3 position type

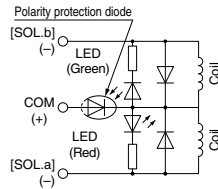

Negative common

Single solenoid

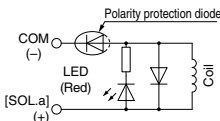

Double solenoid, 3 position type

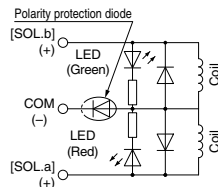

Continuous Duty

Caution

If a valve is energized continuously for a long time, the rise in temperature due to heat-up of the coil may cause a decline in solenoid valve performance, reduce service life, or have adverse effects on peripheral equipment. If a valve will be energized continuously, please be sure to use the "Continuous duty type" with a power saving circuit. In particular, there will be a large increase in temperature if 3 or more neighboring stations are simultaneously continuously energized for a long time, or if the A and B sides are simultaneously continuously energized for a long time in a dual 3 port valve. Please be very careful in such cases. If the continuously energized time exceeds three hours, contact SMC.

With power saving circuit

Compared to the standard products, power consumption is reduced down to approx. 1/3 (in case of SJ3□60T) by cutting the unnecessary wattage required to hold the valve in an energized state. (Effective energizing time is over 67 ms at 24 VDC.)

Electric circuit diagram (with power saving circuit)

In case of positive common, single solenoid

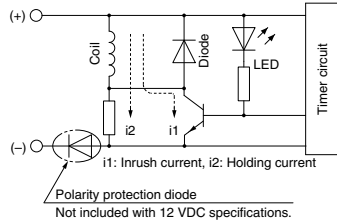

In case of negative common, single solenoid

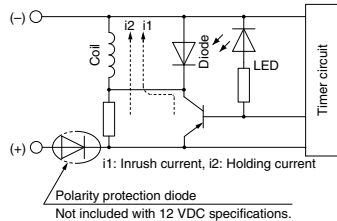

SJ2000/3000 Series

Specific Product Precautions 3



Be sure to read this before handling the products.

Refer to back page 50 for Safety Instructions and pages 3 to 9 for 3/4/5 Port Solenoid Valve Precautions.

Working Principle

With the circuit of page 116, the current consumption, when holding, is reduced to save energy. Please refer to the electric wave form data below.

In case of SJ3□60T, electric waveform of energy saving type

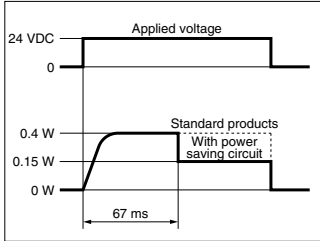

In case of SJ2□60T, electric waveform of energy saving type

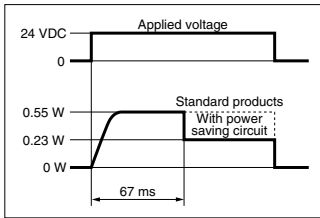

- When a power saving circuit is installed, a diode to prevent reverse current is not available for 12 VDC spec. Therefore, use caution not to connect in reverse.
- Be careful about the allowable voltage fluctuation since a voltage drop of about 0.5 V occurs due to a transistor. (Refer to the solenoid specifications of each valve for details.)

Measures to prevent detours of surge voltage

When the DC power supply is shut off, by the emergency breaking circuit for example, valve misoperation may occur due to surge voltage produced by other electrical parts (such as electromagnetic coils). Please take measures to prevent surges from detouring to the valve (surge protection diode etc.), or use a valve with diode to prevent reverse current (polar: Z type). However, surge countermeasures are provided on the serial unit side of the serial type.

Circuit example

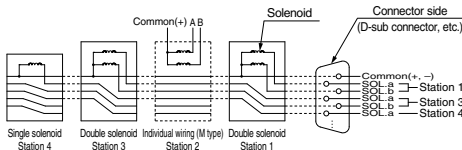

Light Indication

Caution

When equipped with light/surge voltage suppressor, the light window turns red when solenoid a is energized, and it turns green when solenoid b is energized.

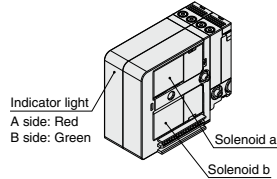

Changing the Connector Entry Direction

Caution

To change the connector's entry direction, set the switch on the top of the connector block to the FREE position, before turning the connector. Make sure to set the switch back to the LOCK position before connecting the connector. (When the switch is difficult to slide, move the connector a little so that it will slide easier.) If an excessive force is applied on the connector in the LOCK position, the connector block may be damaged. Also, using in such a way that the connector floats in the FREE position, it may cause the lead wire, etc. to break. Thus, refrain from using in these ways.

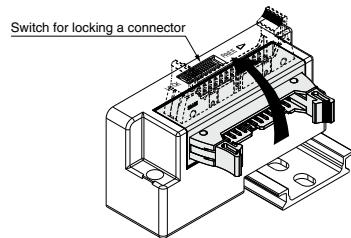

Manifold Mounting

When attaching a manifold to a mounting surface, etc., with bolts, if the entire bottom surface of the DIN rail contacts the mounting surface in a horizontal mounting, it can be used by simply securing both ends of the DIN rail. However, for any other mounting method or for side facing and rear facing, etc., secure the DIN rail with bolts at uniform intervals using the following as a guide: 2 to 5 stations at 2 locations, 6 to 10 stations at 3 locations, 11 to 15 stations at 4 locations, 16 to 20 stations at 5 locations, 21 to 25 stations at 6 locations, 26 to 30 stations at 7 locations and more than 30 stations at 8 locations.

In addition, even in the case of a horizontal mounting, if the mounting surface is subject to vibration, etc., take the same measures indicated above. If secured at fewer than the specified number of locations, warping or twisting may occur in the DIN rail and manifold, causing trouble such as air leakage.

SJ

SY

SY

S0700

S0700

SJ2000/3000 Series

Specific Product Precautions 4



Be sure to read this before handling the products.

Refer to back page 50 for Safety Instructions and pages 3 to 9 for 3/4/5 Port Solenoid Valve Precautions.

Fitting Replacement

Caution

By replacing a valve's fitting assembly, it is possible to change the port size of the 4(A), 2(B), 1(P), and 3/5(E) ports. When replacing it, pull out the fitting assembly after removing the clip with a flat blade screw driver, etc. To mount a new fitting assembly, insert it into place and then fully reinsert the clip.

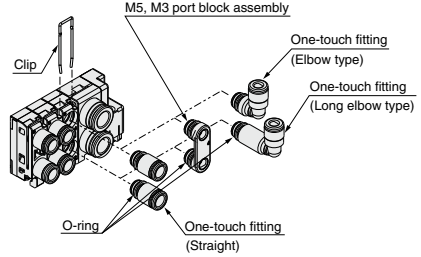

Fitting Assembly Part No.

Metric Size

Port	Port size	Part no.
SJ2000 4(A) 2(B)	ø2 One-touch fitting (Straight)	KJH02-C1
	ø4 One-touch fitting (Straight)	KJH04-C1
	ø2 One-touch fitting (Elbow type)	KJL02-C1
	ø4 One-touch fitting (Elbow type)	KJL04-C1-N
	ø2 One-touch fitting (Long elbow type)	KJW02-C1
	ø4 One-touch fitting (Long elbow type)	KJW04-C1-N
	M3 port block assembly	SJ2000-56-1A
SJ3000 4(A) 2(B)	ø2 One-touch fitting (Straight)	KJH02-C2
	ø4 One-touch fitting (Straight)	KJH04-C2
	ø6 One-touch fitting (Straight)	KJH06-C2
	ø2 One-touch fitting (Elbow type)	KJL02-C2
	ø4 One-touch fitting (Elbow type)	KJL04-C2
	ø6 One-touch fitting (Elbow type)	KJL06-C2-N
	ø2 One-touch fitting (Long elbow type)	KJW02-C2
	ø4 One-touch fitting (Long elbow type)	KJW04-C2
	ø6 One-touch fitting (Long elbow type)	KJW06-C2-N
	M5 port block assembly	SJ3000-56-1A
1(P) 3/5(E)	ø6 One-touch fitting (Straight)	VVQ1000-51A-C6
	ø6 One-touch fitting (Elbow type)	SZ3000-74-1A-L6
	ø6 One-touch fitting (Long elbow type)	SZ3000-74-2A-L6
	ø8 One-touch fitting (Straight)	VVQ1000-51A-C8
	ø8 One-touch fitting (Elbow type)	SZ3000-74-1A-L8
	ø8 One-touch fitting (Long elbow type)	SZ3000-74-2A-L8

Inch Size

Port	Port size	Part no.
SJ2000 4(A) 2(B)	ø1/8" One-touch fitting (Straight)	KJH01-C1
	ø5/32" One-touch fitting (Straight)	KJH03-C1
	ø1/8" One-touch fitting (Elbow type)	KJL01-C1
	ø5/32" One-touch fitting (Elbow type)	KJL03-C1
	ø1/8" One-touch fitting (Long elbow type)	KJW01-C1
	ø5/32" One-touch fitting (Long elbow type)	KJW03-C1
	M3 port block assembly	SJ2000-56-1A
SJ3000 4(A) 2(B)	ø1/8" One-touch fitting (Straight)	KJH01-C2
	ø5/32" One-touch fitting (Straight)	KJH03-C2
	ø1/4" One-touch fitting (Straight)	KJH07-C2
	ø1/8" One-touch fitting (Elbow type)	KJL01-C2
	ø5/32" One-touch fitting (Elbow type)	KJL03-C2
	ø1/4" One-touch fitting (Elbow type)	KJL07-C2
	ø1/8" One-touch fitting (Long elbow type)	KJW01-C2
	ø5/32" One-touch fitting (Long elbow type)	KJW03-C2
	ø1/4" One-touch fitting (Long elbow type)	KJW07-C2
	M3 port block assembly	SJ3000-56-1A
1(P) 3/5(E)	ø1/4" One-touch fitting (Straight)	VVQ1000-51A-N7
	ø5/16" One-touch fitting (Straight)	VVQ1000-51A-N9

Note 1) To change the port size of the 1(P), 3/5(E) ports into the port sizes other than ø8 (straight), specify the change by means of the manifold specification sheet.

Note 2) Be careful to avoid damage or contamination to the O-rings, as this can cause air leakage.

Note 3) When removing a straight-type fitting from a valve, after removing the clip, attach tubing or a plug (KJP-02, KQ2P-□□) to the One-touch fitting, and pull it out while holding the tubing or plug. If it is pulled out while holding the release button of the fitting (resin part), the release button may be damaged.

Note 4) Be sure to turn off the power and stop the supply of air before disassembly. Furthermore, since air may remain inside the actuator, piping and manifold, confirm that the air is completely exhausted before starting any work.

Note 5) While inserting a tubing into an elbow-type fitting, hold the main body of the fitting by hand. Failure to do so will exert an undue force on the valve or the fitting, resulting in air leakage or damage.

Note 6) Each fitting assembly part no. contains 1 pc. Additionally, when the piping is constructed in the same direction using the elbow-type fitting, order the elbow-type and/or long elbow-type fitting.

Clip Part No.

Part no.		Note
SJ2000	SJ3000	
SJ2000-CL-1	SJ3000-CL-1	These part numbers contain 10 pcs. each.

O-ring for Valve Connection (Common to SJ2000/3000)

Part no.	Note
SJ3000-96-1A	The part numbers shown on the left includes parts for 5 units. (10 pcs. each for P, E port and X, PE port)

Specific Product Precautions 5



Be sure to read this before handling the products.

Refer to back page 50 for Safety Instructions and pages 3 to 9 for 3/4/5 Port Solenoid Valve Precautions.

One-touch Fittings

⚠ Caution

The pitch of the SJ series piping ports (A, B etc.) has been set assuming the use of KJ series One-touch fittings. Therefore, when using fittings with an M3 or M5 port block assembly, there may be some interference between fittings, depending on the type and size, so please use after checking dimensions in the catalog for the pipe fitting being used.

1. Tube attachment/detachment for One-touch fittings

1) Tube attachment

- Take a tube having no flaws on its periphery and cut it off at a right angle. When cutting the tube, use tube cutters TK-1, 2 or 3. Do not use pinchers, nippers or scissors, etc. If cutting is done with tools other than tube cutters, the tube may be cut diagonally or become flattened, etc., making a secure installation impossible, and causing problems such as the tube pulling out after installation or air leakage.

Also allow some extra length in the tube.

- Grasp the tube and push it in slowly, inserting it securely all the way into the fitting.
- After inserting the tube, pull on it lightly to confirm that it will not come out. If it is not installed securely all the way into the fitting, this can cause problems such as air leakage or the tube pulling out.

2) Tube detachment

- The 4(A) and 2(B) ports use the KJ series, so the tube can be removed by pressing on part of the release button. However, for the 1(P) and 3/5(E) ports, please press the release button evenly as before.
- Pull out the tube while holding down the release button so that it does not come out. If the release button is not pressed down sufficiently, there will be increased bite on the tube and it will become more difficult to pull it out.
- When the removed tube is to be used again, cut off the portion which has been chewed before reusing it. If the chewed portion of the tube is used as is, this can cause trouble such as air leakage or difficulty in removing the tube.

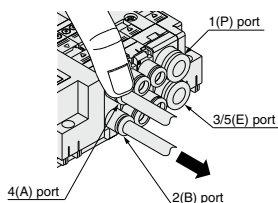

Hold down part of the release button with your finger or a similar tool, as shown in the diagram, and pull out in the direction indicated by the arrow.

Other Tube Brands

⚠ Caution

1. When using other than SMC brand tube, confirm that the following specifications are satisfied with respect to the tube outside diameter tolerance.

- Nylon tube within ± 0.1 mm
- Soft nylon tube within ± 0.1 mm
- Polyurethane tube within $+0.15$ mm, within -0.2 mm

Do not use tube which does not meet these outside diameter tolerances. It may not be possible to connect them, or they may cause other trouble, such as air leakage or the tube pulling out after connection.

How to Use Plug Connector

⚠ Caution

When attaching and detaching a connector, first shut off the electric power and the air supply.

Also, crimp the lead wires and sockets securely.

1. Connector attachment/detachment

- To attach a connector, hold the lever and connector unit between your fingers and insert straight onto the pins of the solenoid valve so that the lever's pawl is pushed into the groove and locks.
- To detach a connector, remove the pawl from the groove by pushing the lever downward with your thumb, and pull the connector straight out.

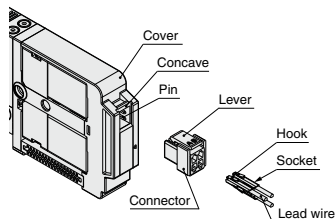

2. Crimping of lead wires and sockets

Peel 3.2 to 3.7 mm of the tip of lead wire, enter the core wires neatly into a socket and crimp it with a special crimp tool. Be careful so that the cover of lead wire does not enter into the crimping part. (Please contact SMC for the dedicated crimping tools.)

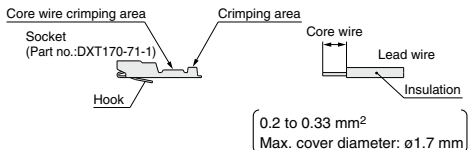

SJ2000/3000 Series

Specific Product Precautions 6



Be sure to read this before handling the products.

Refer to back page 50 for Safety Instructions and pages 3 to 9 for 3/4/5 Port Solenoid Valve Precautions.

How to Use Plug Connector

⚠ Caution

3. Lead wires with sockets attachment/detachment

• Attachment

Insert the sockets into the square holes of the connector (with A, B, C, and N indication), and continue to push the sockets all the way in until the lock by hooking into the seats in the connector. (When they are pushed in, their hooks open and they are locked automatically.) Next, confirm that they are locked by pulling lightly on the lead wires.

• Detachment

To detach a socket from a connector, pull out the lead wire while pressing the socket's hook with a stick having a thin tip (approx. 1 mm). If the socket is used again, spread the hook outward.

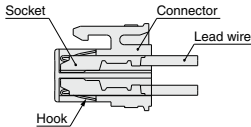

<Positive common>

Single solenoid

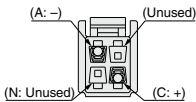

Double solenoid

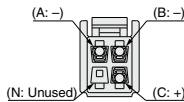

<Negative common>

Single solenoid

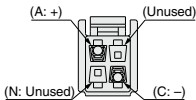

Double solenoid

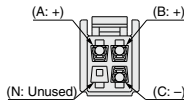

Plug Connector Lead Wire Length

⚠ Caution

Plug connector lead wires have a standard length of 300 mm, however, the following lengths are also available.

Connector Assembly Part No.

Single solenoid

SJ3000-46-S-□ (for positive common)

SJ3000-47-S-□ (for negative common)

Double solenoid, 3 position type, 4 position type

SJ3000-46-D-□ (for positive common)

SJ3000-47-D-□ (for negative common)

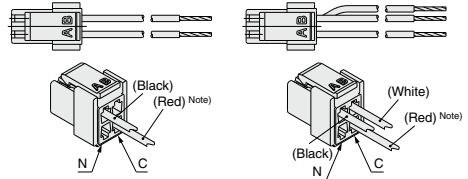

Note) In case of negative common, the lead wire changes from red to yellow.

For single solenoid:

Lead wire length	Part No.
Nil	300 mm
6	600 mm
10	1000 mm
15	1500 mm
20	2000 mm
25	2500 mm
30	3000 mm
50	5000 mm

For double solenoid

For 3 position type :

For 4 position type

Common specifications

46	For positive common
47	For negative common

For single solenoid

Without lead wire : SJ3000-46-S-N (positive/negative common)

(Connector, Socket x 2 pcs. only)

For double solenoid

Without lead wire : SJ3000-46-D-N (positive/negative common)

(Connector, Socket x 3 pcs. only)

How to Order

Include the connector assembly part number together with the part number for the plug connector's solenoid valve without connector.

(Example) In case of lead wire length 2000 mm and positive common

SJ3160-5MOZ-C6

SJ3000-46-S-20

Connector Assembly for Manifolds (for Junction Common)

⚠ Caution

Using the connector assembly (for junction common) for solenoid valves installed in the manifold reduces the labor involved in wiring work because common wiring for all solenoid valves is integrated into a single wire.

SJ2000/3000 Series

Specific Product Precautions 7



Be sure to read this before handling the products.

Refer to back page 50 for Safety Instructions and pages 3 to 9 for 3/4/5 Port Solenoid Valve Precautions.

Connector Assembly Part No. (for Junction Common)

Single solenoid

SJ3000-46-SC-□ (for positive common)

SJ3000-47-SC-□ (for negative common)

Double solenoid,
3 position type, 4 position type

SJ3000-46-DC-□ (for positive common)

SJ3000-47-DC-□ (for negative common)

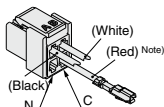
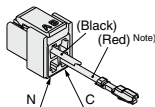
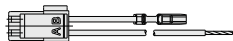

Note) In case of negative common, the lead wire changes from red to yellow.

For single solenoid:

SJ3000-46-SC-□

For double solenoid

SJ3000-46-DC-□

For 3 position type :

For 4 position type

Common specifications	
46	For positive common
47	For negative common

Lead wire length	
Nil	300 mm
6	600 mm
10	1000 mm
15	1500 mm
20	2000 mm
25	2500 mm
30	3000 mm
50	5000 mm

• For junction common

How to Order

Indicate the part no. of the connector assembly for the manifold and solenoid valve.

If the arrangement is complicated, please specify them by means of the manifold specification sheet.

Note 1) Applications like connectors not wired to a valve is not possible.

Note 2) For the solenoid valve, please designate "No connector (MOZ)" for the connector type.

Note 3) Connector assembly with lead wire for place where the signals are transmitted to the common wiring. (Only the valves of first station and/or last station of manifold are compatible to connector with lead wire for common.)

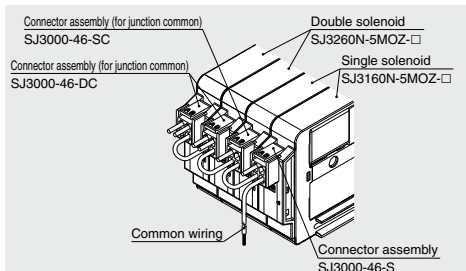

(Example)

- SS5J3-60-04U 1set
- * SJ3160N-5MOZ-C6 ... 2set
- * SJ3260N-5MOZ-C6 ... 2set
- * SJ3000-46-S 1set (Connector assembly for single solenoid)
- * SJ3000-46-SC 1set (Connector assembly for single solenoid) (for junction common)
- * SJ3000-46-DC 2set (Connector assembly for double solenoid) (for junction common)

The asterisk denotes the symbol for assembly. Prefix it to the part nos. of the solenoid valve, etc.

Wiring Instructions for Connector Assembly (for Junction Common)

Caution

If only connector assembly (for junction common) is ordered, please wire according to the instructions in the diagram below. For details on socket mounting, please refer to "How to Use Plug Connector" on page 119.

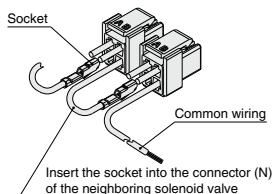

SJ

SY

SY

S0700

S0700



SJ2000/3000 Series

Specific Product Precautions 8

Be sure to read this before handling the products.

Refer to back page 50 for Safety Instructions and pages 3 to 9 for 3/4/5 Port Solenoid Valve Precautions.

One-touch Fittings

Caution

When fittings are used, they may interfere with one another depending on their types and sizes. Therefore, the dimensions of the fittings to be used should first be confirmed in their respective catalogs.

Fittings whose compliance with the SJ series is already confirmed are stated below. If the fitting within the applicable range is selected, there will not be any interference.

Applicable Fittings: KQ2H, KQ2S Series KJH, KJS Series

Series	Model	Piping port	Port size	Fitting	Applicable tubing O.D.			
					ø2	ø3.2	ø4	ø6
SJ3000 (10 mm pitch)	SJ3□60-□□-M5	4A, 2B	M5	KQ2H KJH	[Shaded bar]			
				KQ2S KJS	[Shaded bar]			
SJ2000 (7.5 mm pitch)	SJ2□60-□□-M3	4A, 2B	M3	KQ2H KJH	[Shaded bar]			
				KQ2S KJS	[Shaded bar]			
SJ3A6 (10 mm pitch)	SJ3A6-□□	2B	M5	KQ2H KJH	[Shaded bar]			
				KQ2S KJS	[Shaded bar]			