

# Compact Cylinder with Air Cushion

## RQ Series

ø20, ø25, ø32, ø40, ø50, ø63, ø80, ø100

Uses a unique air cushion mechanism with no cushion ring.



The **new standard** for the future  
New Air Cushion Cylinder



Model	Mounting	Rod end configuration	Standard stroke								Auto switch
			15	20	25	30	40	50	75	100	
R(D)Q□20	<ul style="list-style-type: none"> <li>•Through-hole</li> <li>•Double end tapped</li> <li>•Foot type</li> <li>•Rod side flange type</li> <li>•Head side flange type</li> <li>•Double clevis type</li> </ul>	<ul style="list-style-type: none"> <li>•Female thread</li> <li>•Male thread</li> </ul>	●	●	●	●	●	●	●	●	<ul style="list-style-type: none"> <li>•Direct mounting auto switch (ø20 to ø100)</li> </ul>
R(D)Q□25			●	●	●	●	●	●	●	●	
R(D)Q□32			●	●	●	●	●	●	●	●	
R(D)Q□40			●	●	●	●	●	●	●	●	
R(D)Q□50			●	●	●	●	●	●	●	●	
R(D)Q□63			●	●	●	●	●	●	●	●	
R(D)Q□80			●	●	●	●	●	●	●	●	
R(D)Q□100			●	●	●	●	●	●	●	●	

\* Size ø20 and ø25 have through-holes and double end taps in common.

# Future new standard for shock elimination,



Employs a new construction  
for the air cushion mechanism.



Compact Cylinder with Air Cushion

## RQ Series



## Unique air cushion construction with no cushion ring

Elimination of the cushion ring used in current cushion ring type air cushions has made it possible to reduce the overall length of the cylinder. This produces an air cushion cylinder which retains the merits of a compact design.

### Working principle

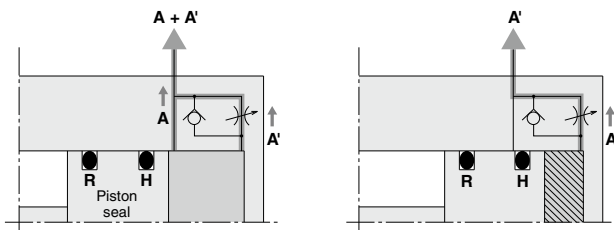

- ① When the piston is retracting, exhaust is discharged from both A and A' until piston seal H passes the air passage A.
- ② After piston seal H has passed the air passage A, exhaust is discharged only from A'. The section marked with diagonal lines becomes a cushion chamber, and a cushioning effect is achieved.
- ③ When air is supplied for piston extension, the check seal opens and the piston starts with no delay.

# noise reduction and improvement in repeatability

## Minimal extended dimensions from +2.5 mm to 13 mm

(Compared with series CDQS/CDQ2 of the same bore size with auto switches)

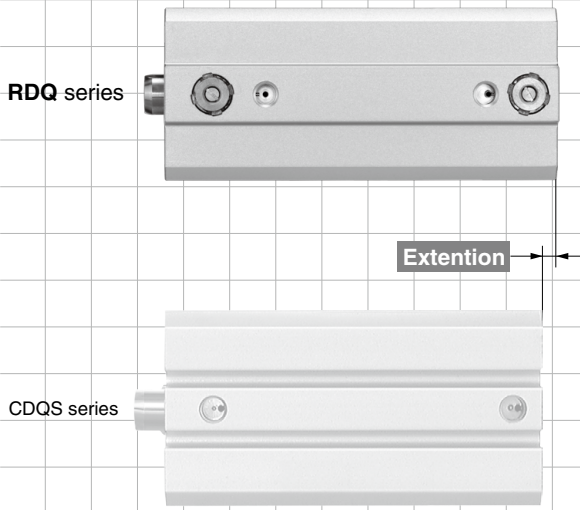

Series	Bore size	Extended dimension	Comparable cylinder
RDQ series	20	+2.5 mm	CDQS series
	25	+4 mm	
	32	+4 mm	
	40	+4.5 mm	CDQ2 series
	50	+9 mm	
	63	+9 mm	
	80	+10 mm	
100	+13 mm		

## Nearly three times the allowable kinetic energy

(Compared to the CQS/CQ2 series with rubber bumper)  
Improved energy absorption allows selection of a cylinder that is two sizes smaller for the same kinetic energy.

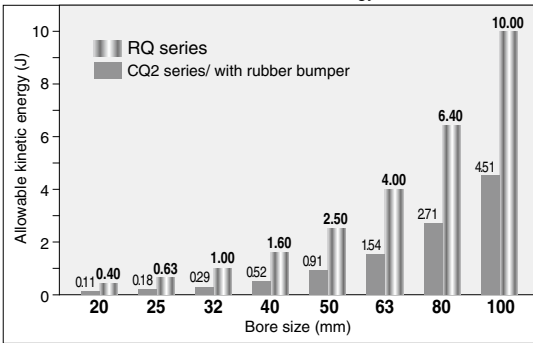

## Interchangeable mounting

The mounting dimension "M" is the same as the compact cylinder CQS/CQ2 series.  
(CQS/CQ2 mounting brackets can be used without any changes.)

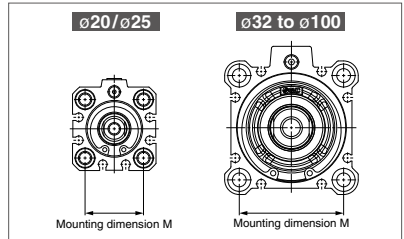

## Improved repeatability

The piston contact surface at the stroke end is metal, providing improved repeatability for the stopping position as compared with a rubber bumper.

## Improved noise reduction (Stroke end impact noise reduced)

- Decrease of 19dB or more (Compared with the CQ2 series without cushion)
- Decrease of 14dB or more (Compared with the CQ2 series with rubber bumper)

# Added compact type foot brackets

- Compact foot bracket has the same width as the cylinder. Overall width reduced by up to **42%** (for  $\phi 20$ )

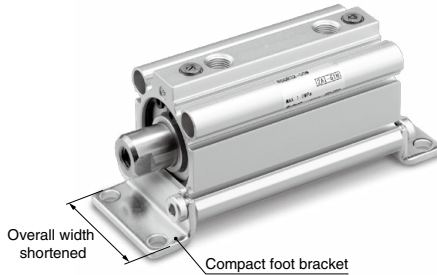

## ■ More compact installation space possible

- Short pitch mounting is possible. ● Allows installation close against a wall.

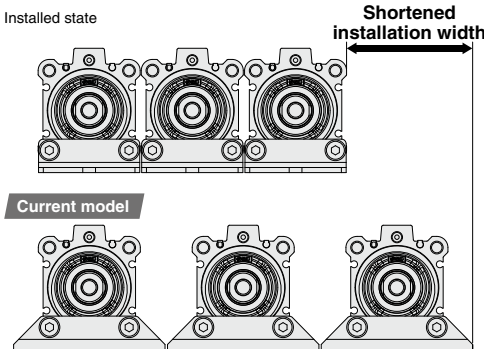

Bore size (mm)	Compact foot type width A (mm)	Current foot type width B (mm)	Reduced width for short pitch mounting (mm)		
			1 unit	2 units	3 units
20	36	62	26	52	78
25	40	66	26	52	78
32	45	71	26	52	78
40	52	78	26	52	78
50	64	95	31	62	93
63	77	113	36	72	108
80	98	140	42	84	126
100	117	162	45	90	135

\* Short pitch mounting is possible only without auto switch.

- Height from the bottom of brackets to the center of a cylinder is the same as the current model.

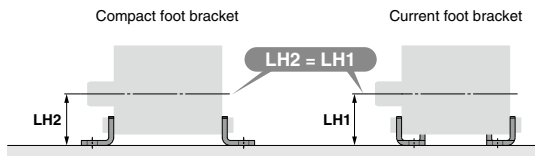

# Compact Cylinder with Air Cushion

# RQ Series

ø20, ø25, ø32, ø40, ø50, ø63, ø80, ø100

## How to Order

With auto switch

RQ B 32 - 50 -   
 RDQ B 32 - 50 - M9BW

With auto switch  
(Built-in magnet)

Made to Order  
For details, refer to page 1040.

Mounting bracket

<b>B</b>	Through-hole (Standard)	<b>F</b>	Rod side flange type
<b>A</b>	Both ends tapped type	<b>G</b>	Head side flange type
<b>L</b>	Foot type	<b>D</b>	Double clevis type
<b>LC</b>	Compact foot type		

- Note 1) Mounting brackets are packed together when shipped (unassembled).  
 Note 2) Since sizes ø20 and ø25 have a body with type B (Through-hole) and type A (Both ends tapped type) in common, there is no type A part number. Example) RQA 20-30 does not exist.  
 Note 3) Cylinder mounting bolts are not included. Order them separately referring to Mounting Bolts for ROB on page 1041.

Number of auto switches

<b>Nil</b>	2 pcs.
<b>S</b>	1 pc
<b>n</b>	"n" pcs.

Auto switch

<b>Nil</b>	Without auto switch
------------	---------------------

\* Refer to the table below for the applicable auto switch model.

Body option

<b>Nil</b>	Rod end female thread (Standard)
<b>M</b>	Rod end male thread

Cylinder stroke (mm)

Refer to "Standard Stroke" on page 1040.

Thread type

<b>Nil</b>	M thread	ø20, 25
	Rc	
<b>TN</b>	NPT	ø32 to ø100
<b>TF</b>	G	

Bore size

<b>20</b>	20 mm	<b>50</b>	50 mm
<b>25</b>	25 mm	<b>63</b>	63 mm
<b>32</b>	32 mm	<b>80</b>	80 mm
<b>40</b>	40 mm	<b>100</b>	100 mm

### Built-in Magnet Cylinder Model

If a built-in magnet cylinder without an auto switch is required, there is no need to enter the symbol for the auto switch.  
(Example) RDQL40-50

### Applicable Auto Switches/Refer to pages 1271 to 1365 for further information on auto switches.

Type	Special function	Electrical entry	Indicator light	Wiring (Output)	Load voltage		Auto switch model		Lead wire length (m)				Pre-wired connector	Applicable load				
					DC	AC	Perpendicular	In-line	0.5 (Nil)	1 (M)	3 (L)	5 (Z)			None (N)			
Solid state auto switch	—	Grommet	No	3-wire (NPN)	5 V	—	M9NV	M9N	●	●	●	○	○	IC circuit				
				3-wire (PNP)	12 V				●	●	●	○	○					
				2-wire	12 V				●	●	●	○	○					
				3-wire (NPN)	5 V				●	●	●	○	○					
	Diagnostic indicator (2-color indicator)	Grommet	Yes	3-wire (PNP)	12 V				M9B	M9B	●	●	●		○	○	○	IC circuit
				2-wire	12 V				M9NVV	M9NW	●	●	●		○	○	○	
				3-wire (NPN)	5 V				M9PWV	M9PW	●	●	●		○	○	○	
				3-wire (PNP)	12 V				M9BWW	M9BW	●	●	●		○	○	○	
Water resistance (2-color indicator)	Grommet	No	3-wire (NPN)	5 V	M9NAV*1	M9NA*1	○	○	●	○	○	○	IC circuit					
			3-wire (PNP)	12 V	M9PAV*1	M9PA*1	○	○	●	○	○	○						
			2-wire	12 V	M9BAV*1	M9BA*1	○	○	●	○	○	○						
			2-wire	—	—	P3DWA**	●	—	●	●	—	○	—					
Reed auto switch	—	Grommet	Yes	3-wire (NPN equiv.)	5 V	A96V	A96	●	—	●	—	—	IC circuit					
				2-wire	12 V	A93V*2	A93	●	●	●	●	—	—	Relay, PLC				
					24 V	5 V, 12 V	A90V	A90	●	—	●	—	—	IC circuit				

\*1 Water resistant type auto switches can be mounted on the above models, but in such case SMC cannot guarantee water resistance.

\*2 1 m type lead wire is only applicable to D-A93.

\* Lead wire length symbols: 0.5 m..... Nil (Example) M9NV  
 1 m..... M (Example) M9NVM  
 3 m..... L (Example) M9NLV  
 5 m..... Z (Example) M9NZV  
 None..... N (Example) J79CN

\* Solid state auto switches marked with a "○" are produced upon receipt of order.

\*\* The D-P3DWA□ is mountable on bore size ø25 to ø100.

\* Besides the models in the above catalog, there are some other auto switches that are applicable. For more information, refer to page 1056.

\* Refer to pages 1340 and 1341 for the details of auto switches with a pre-wired connector.

\* When mounting brackets (foot/flange type) are used, then in some cases auto switches cannot be retrofitted.



**Symbol**  
Air cushion

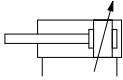

**Made to Order**

[Click here for details](#)

Symbol	Specifications
-XA <input type="checkbox"/>	Change of Rod End Shape
-XC4	With heavy duty scraper
-XC35	With coil scraper (For ø32 to 100 only)

## Allowable kinetic energy

Refer to "Selection" on page 1057 regarding the allowable kinetic energy.

## Effective Cushion Length

Bore size (mm)	20	25	32	40	50	63	80	100
Effective cushion length (mm)	5.8	6.1	6.6	6.6	7.1	7	7.5	8

## Mounting Bracket Part No.

Bore size (mm)	Foot <sup>Note 1)</sup>	Compact foot	Flange	Double clevis
20	CQS-L020	CQS-LC020	CQS-F020	CQS-D020
25	CQS-L025	CQS-LC025	CQS-F025	CQS-D025
32	CQ-L032	CQ-LC032	CQ-F032	CQ-D032
40	CQ-L040	CQ-LC040	CQ-F040	CQ-D040
50	CQ-L050	CQ-LC050	CQ-F050	CQ-D050
63	CQ-L063	CQ-LC063	CQ-F063	CQ-D063
80	CQ-L080	CQ-LC080	CQ-F080	CQ-D080
100	CQ-L100	CQ-LC100	CQ-F100	CQ-D100

Note 1) When ordering foot/compact foot brackets, order 2 pieces per cylinder.

Note 2) The following parts are included with each bracket.  
Foot/Compact foot/Flange : Body mounting bolts.  
Double clevis: Clevis pins, type C retaining ring for axis, and Body mounting bolts.

## Specifications

Bore size (mm)	20	25	32	40	50	63	80	100
Lubrication	Not required (non-lube)							
Fluid	Air							
Proof pressure	1.5 MPa							
Maximum operating pressure	1.0 MPa							
Minimum operating pressure	0.05 MPa							
Ambient and fluid temperature	Without auto switch: -10°C to 70°C (No freezing)							
	With auto switch: -10°C to 60°C (No freezing)							
Rod end thread	Female thread							
Stroke length tolerance	+1.0 0							
Mounting	Through-hole							
Piston speed	50 to 500 mm/s							

## Standard Stroke

Bore size (mm)	Standard stroke (mm)
20, 25	15, 20, 25, 30, 40, 50
32, 40	20, 25, 30, 40, 50, 75, 100
50, 63	30, 40, 50, 75, 100
80, 100	40, 50, 75, 100

## Manufacture of Intermediate Stroke

Description	Exclusive body	
Part no.	Refer to "How to Order" for standard model	
Method	Available in stroke increments of 1mm, using an exclusive body for the specified stroke.	
Stroke range	Bore size	Stroke range
	20, 25	16 to 49
	32, 40	21 to 99
	50, 63	31 to 99
	80, 100	41 to 99
Example	Part no.: RQB32-47 A special tube is manufactured for a 47mm stroke.	

## Theoretical Output

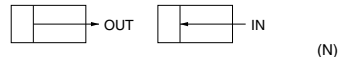

Bore size (mm)	Operating direction	Operating pressure (MPa)		
		0.3	0.5	0.7
20	IN	71	118	165
	OUT	94	157	220
25	IN	113	189	264
	OUT	147	245	344
32	IN	181	302	422
	OUT	241	402	563
40	IN	317	528	739
	OUT	377	628	880
50	IN	495	825	1150
	OUT	589	982	1370
63	IN	841	1400	1960
	OUT	935	1560	2180
80	IN	1360	2270	3170
	OUT	1510	2510	3520
100	IN	2140	3570	5000
	OUT	2360	3930	5500



# RQ Series

## Construction

ø20 to ø40

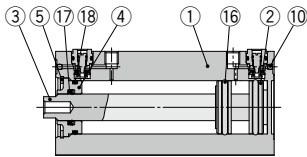

With auto switch (Built-in magnet)

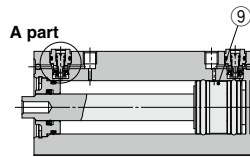

ø50 to ø100

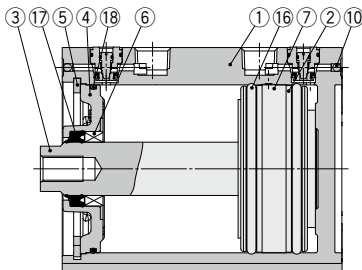

With auto switch (Built-in magnet)

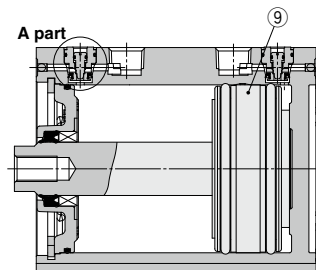

M: Rod end male thread

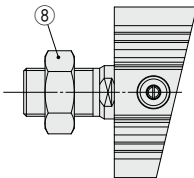

Details of A part

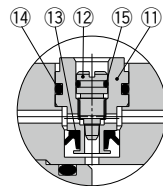

## Component Parts

No.	Description	Material	Note
1	Cylinder tube	Aluminum alloy	Hard anodized
2	Piston	Aluminum alloy	
3	Piston rod	Stainless steel	ø20, ø25
		Carbon steel	ø32 to ø100, Hard chrome plated
4	Collar	Aluminum alloy	ø20 to ø40, Anodized
		Aluminum alloy casted	ø50 to ø100, Chromated, Painted
5	Retaining ring	Carbon tool steel	Phosphate coating
6	Bushing	Bearing alloy	ø50 to ø100
7	Wear ring	Resin	ø63 to ø100
8	Rod end nut	Carbon steel	Zinc chromated
9	Magnet	—	
10	Steel ball	High carbon chrome bearing steel	
11	Check seal retainer	Brass	Electroless nickel plated
12	Cushion needle	Stainless steel	
13	Check seal	NBR	
14	Check gasket	NBR	
15	Needle gasket	NBR	
16	Piston seal	NBR	
17	Rod seal	NBR	
18	Tube gasket	NBR	

## Replacement Parts/Seal Kit

Bore size (mm)	Part no.	Contents
20	RQB20-PS	Set of nos. above (16, 17, 18).
25	RQB25-PS	
32	RQB32-PS	
40	RQB40-PS	
50	RQB50-PS	
63	RQB63-PS	
80	RQB80-PS	
100	RQB100-PS	

\* Seal kit includes 16, 17 and 18. Order the seal kit, based on each bore size.

\* Since the seal kit does not include a grease pack, order it separately.

Grease pack part no.: GR-S-010 (10 g)



## Dimensions: $\varnothing 20, \varnothing 25$

\* For the auto switch mounting position and its mounting height, refer to pages 1054 and 1055.

### Basic type (Through-hole/Both ends tapped common): RQB/RDQB

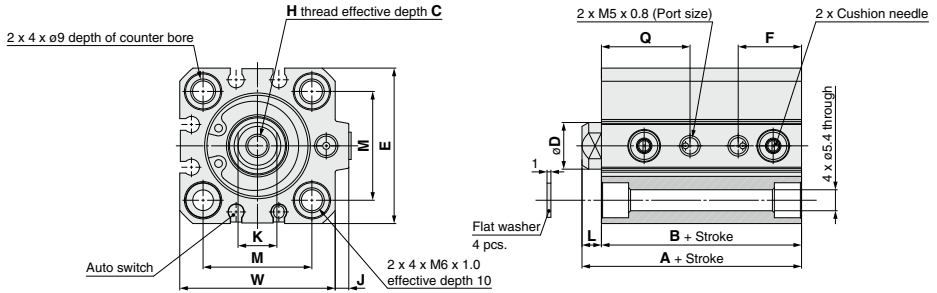

Bore size (mm)	Stroke range (mm)	A	B	C	D	E	F	H	J	K	L	M	Q	W
20	15 to 50	36.5	32	7	10	36	15.5	M5 x 0.8	3	8	4.5	25.5	21	39
25	15 to 50	41.5	36.5	12	12	40	17	M6 x 1.0	3.5	10	5	28	23	43.5

\* Refer to page 1052 for details on rod end nut and accessories.

- Add the stroke to calculate the length of intermediate strokes.

### Rod end male thread

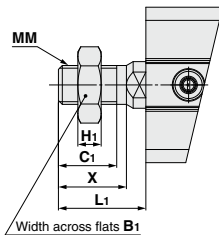

Bore size (mm)	B <sub>1</sub>	H <sub>1</sub>	C <sub>1</sub>	X	MM	L <sub>1</sub>
20	13	5	12	14	M8 x 1.25	18.5
25	17	6	15	17.5	M10 x 1.25	22.5

# RQ Series

## Mounting Bracket Dimensions

### Foot type: RQL/RDQL

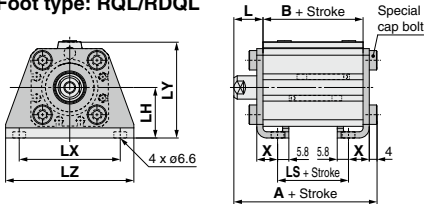

#### Rod end male thread

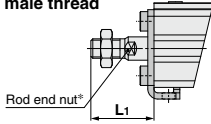

### Compact foot type: RQLC/RDQLC

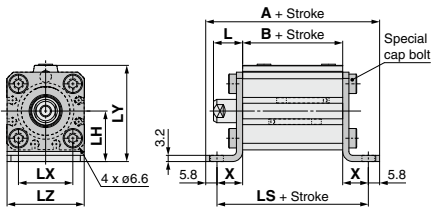

#### Rod end male thread

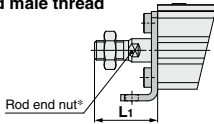

### Rod side flange type: RQF/RDQF

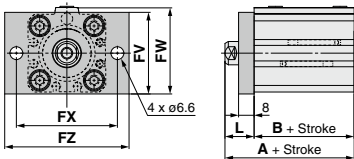

#### Rod end male thread

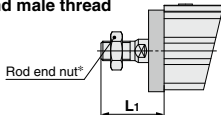

### Foot Type

Bore size (mm)	Stroke range (mm)	A	B	LS	L
20	15 to 50	53.7	32	20	14.5
25	15 to 50	58.7	36.5	21.5	15

Bore size (mm)	L1	LH	LX	LY	LZ	X
20	28.5	24	48	45	62	9.2
25	32.5	26	52	49.5	66	10.7

Foot bracket material: Carbon steel  
Surface treatment: Nickel plated

### Compact Foot Type

Bore size (mm)	Stroke range (mm)	A	B	LS	L
20	15 to 50	70	32	58.4	14.5
25	15 to 50	74.5	36.5	62.9	15

Bore size (mm)	L1	LH	LX	LY	LZ	X
20	28.5	24	25.5	45	36	13.2
25	32.5	26	28	49.5	40	13.2

Foot bracket material: Carbon steel  
Surface treatment: Zinc chromated

### Rod Side Flange Type

Bore size (mm)	Stroke range (mm)	A	B	L
20	15 to 50	46.5	32	14.5
25	15 to 50	51.5	36.5	15

Bore size (mm)	L1	FV	FW	FX	FZ
20	28.5	39	40.5	48	60
25	32.5	42	44.5	52	64

Flange material: Carbon steel  
Surface treatment: Nickel plated

## Mounting Bracket Dimensions

### Head side flange type: RQG/RDQG

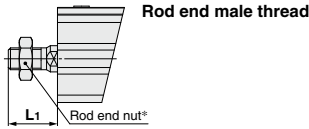
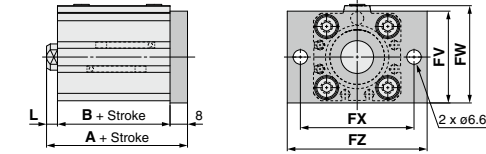

### Head Side Flange Type

Bore size (mm)	Stroke range (mm)	A	L	L <sub>1</sub>
20	15 to 50	44.5	4.5	18.5
25	15 to 50	49.5	5	22.5

\* All dimensions but A, L and L<sub>1</sub> are identical to those of the rod side flange type.

Flange material: Carbon steel  
Surface treatment: Nickel plated

### Double clevis type: RQD/RDQD

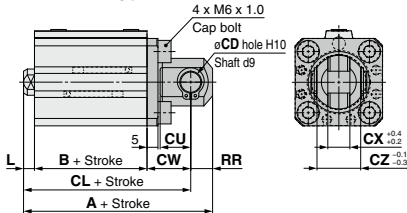

### Double Clevis Type

Bore size (mm)	Stroke range (mm)	A	B	CL	CD	CU
20	15 to 50	63.5	32	54.5	8	12
25	15 to 50	71.5	36.5	61.5	10	14

Bore size (mm)	CW	CX	CZ	L	L <sub>1</sub>	RR
20	18	8	16	4.5	18.5	9
25	20	10	20	5	22.5	10

\* Double clevis pins and retaining rings are included in the package.

Double clevis bracket material: Carbon steel  
Surface treatment: Nickel plated

\* Refer to page 1052 for details on rod end nut and accessories.

# RQ Series

## Dimensions: $\varnothing 32$ , $\varnothing 40$ , $\varnothing 50$

\* For the auto switch mounting position and its mounting height, refer to pages 1054 and 1055.

### Basic type (Through-hole): RQB/RDQB

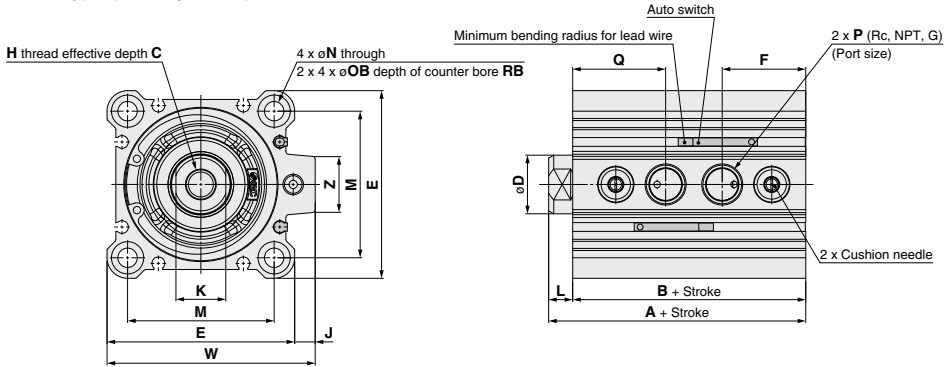

Bore size (mm)	Stroke range (mm)	A	B	C	D	E	F	H	J	K	L	M	N
32	20 to 100	44	37	13	16	45	18.5	M8 x 1.25	4.5	14	7	34	5.5
40	20 to 100	51	44	13	16	52	20	M8 x 1.25	5	14	7	40	5.5
50	30 to 100	57.5	49.5	15	20	64	28.5	M10 x 1.5	7	17	8	50	6.6

Bore size (mm)	OB	P	Q	RB	W	Z
32	9	1/8	23	7	49.5	14
40	9	1/8	28	7	57	14
50	11	1/4	31.5	8	71	19

\* Refer to page 1052 for details on rod end nut and accessories.

• Add the stroke to calculate the length of intermediate strokes.

### Both ends tapped type: RQA/RDQA

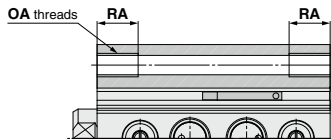

Bore size (mm)	OA	RA
32	M6 x 1.0	10
40	M6 x 1.0	10
50	M8 x 1.25	14

### Rod end male thread

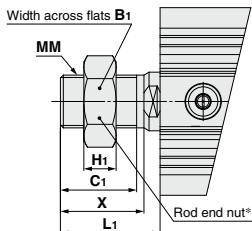

Bore size (mm)	B1	H1	C1	X	MM	L1
32	22	8	20.5	23.5	M14 x 1.5	28.5
40	22	8	20.5	23.5	M14 x 1.5	28.5
50	27	11	26	28.5	M18 x 1.5	33.5

## Mounting Bracket Dimensions

### Foot type: RQL/RDQL

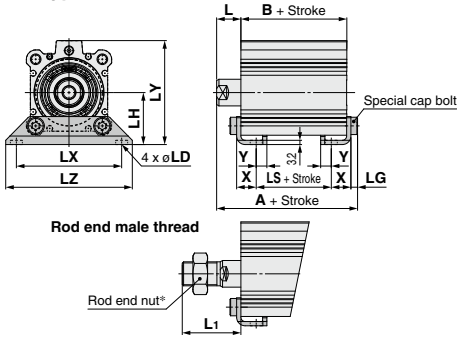

### Foot Type

Bore size (mm)	Stroke range (mm)	A	B	LS	L	L1	LD
32	20 to 100	61.2	37	21	17	38.5	6.6
40	20 to 100	68.2	44	28	17	38.5	6.6
50	30 to 100	75.7	49.5	26.5	18	43.5	9

Bore size (mm)	LG	LH	LX	LY	LZ	X	Y
32	4	30	57	57	71	11.2	5.8
40	4	33	64	64	78	11.2	7
50	5	39	79	78	95	14.7	8

Foot bracket material: Carbon steel  
Surface treatment: Nickel plated

### Compact foot type: RQLC/RDQLC

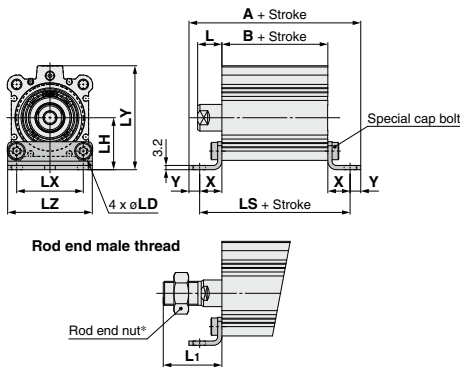

### Compact Foot Type

Bore size (mm)	Stroke range (mm)	A	B	LS	L	L1	LD
32	20 to 100	76	37	64.4	17	38.5	6.6
40	20 to 100	85.4	44	71.4	17	38.5	6.6
50	30 to 100	98.9	49.5	82.9	18	43.5	9

Bore size (mm)	LH	LX	LY	LZ	X	Y
32	30	34	57	45	13.7	5.8
40	33	40	64	52	13.7	7
50	39	50	78	64	16.7	8

Foot bracket material: Carbon steel  
Surface treatment: Zinc chromated

### Rod side flange type: RQF/RDQF

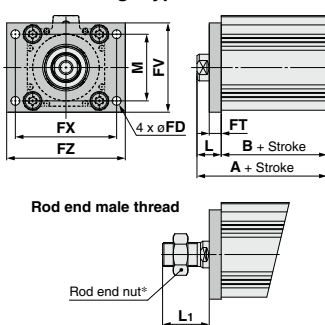

### Rod Side Flange Type

Bore size (mm)	Stroke range (mm)	A	B	FD	FT	FV
32	20 to 100	54	37	5.5	8	48
40	20 to 100	61	44	5.5	8	54
50	30 to 100	67.5	49.5	6.6	9	67

Bore size (mm)	FX	FZ	L	L1	M
32	56	65	17	38.5	34
40	62	72	17	38.5	40
50	76	89	18	43.5	50

Flange bracket material: Carbon steel  
Surface treatment: Nickel plated

## Mounting Bracket Dimensions

### Head side flange type: RQG/RDQG

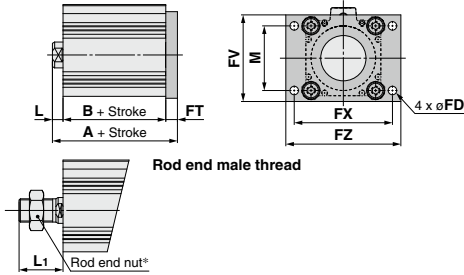

### Head Side Flange Type

Bore size (mm)	Stroke range (mm)	A	L	L1
32	20 to 100	52	7	28.5
40	20 to 100	59	7	28.5
50	30 to 100	66.5	8	33.5

\* All dimensions but A, L and L1 are identical to those of the rod side flange type. Flange bracket material: Carbon steel  
Surface treatment: Nickel plated

### Double clevis type: RQD/RDQD

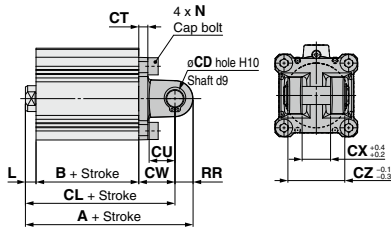

### Double Clevis Type

Bore size (mm)	Stroke range (mm)	A	B	CL	CD	CT	CU
32	20 to 100	74	37	64	10	5	14
40	20 to 100	83	44	73	10	6	14
50	30 to 100	99.5	49.5	85.5	14	7	20

Bore size (mm)	CW	CX	CZ	L	L1	N	RR
32	20	18	36	7	28.5	M6 x 1.0	10
40	22	18	36	7	28.5	M6 x 1.0	10
50	28	22	44	8	33.5	M8 x 1.25	14

\* Double clevis pins and retaining rings are included in the package. Double clevis bracket material: Cast iron  
Surface treatment: Painted  
\* Refer to page 1052 for details on rod end nut and accessories.

## Dimensions: $\phi 63$ to $\phi 100$

\* For the auto switch mounting position and its mounting height, refer to pages 1054 and 1055.

### Basic type (Through-hole)

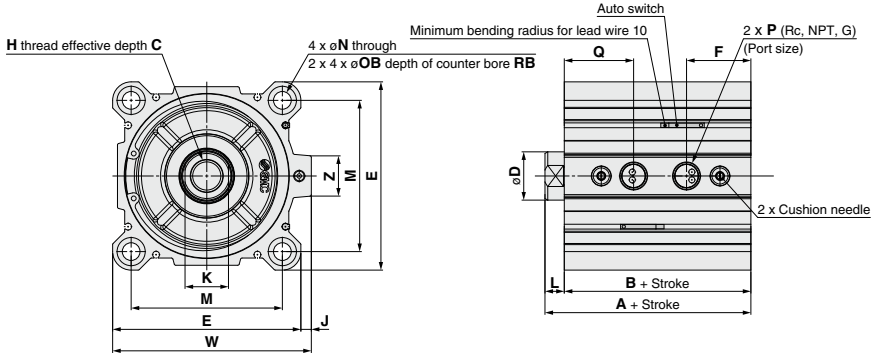

Bore size (mm)	Stroke range (mm)	A	B	C	D	E	F	H	J	K	L	M	N	OB	P
63	30 to 100	63	55	15	20	77	31	M10 x 1.5	7	17	8	60	9	14	1/4
80	40 to 100	73.5	63.5	21	25	98	35.5	M16 x 2.0	6	22	10	77	11	17.5	3/8
100	40 to 100	88	76	27	30	117	40	M20 x 2.5	6.5	27	12	94	11	17.5	3/8

Bore size (mm)	Q	RB	W	Z
63	34	10.5	84	19
80	39	13.5	104	26
100	43	13.5	123.5	26

\* Refer to page 1052 for details on rod end nut and accessories.

• Add the stroke to calculate the length of intermediate strokes.

### Both ends tapped type: RQA/RDQA

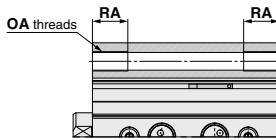

Bore size (mm)	OA	RA
63	M10 x 1.5	18
80	M12 x 1.75	22
100	M12 x 1.75	22

### Rod end male thread

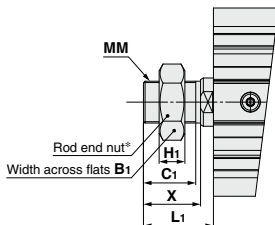

Bore size (mm)	B <sub>1</sub>	H <sub>1</sub>	C <sub>1</sub>	X	MM	L <sub>1</sub>
63	27	11	26	28.5	M18 x 1.5	33.5
80	32	13	32.5	35.5	M22 x 1.5	43.5
100	41	16	32.5	35.5	M26 x 1.5	43.5

# RQ Series

## Mounting Bracket Dimensions

### Foot type: RQL/RDQL

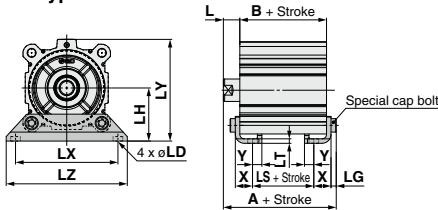

Rod end male thread

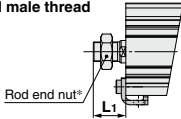

### Foot Type

Bore size (mm)	Stroke range (mm)	A	B	LS	L	L1	LD	LG	LH	LT
63	30 to 100	81.2	55	29	18	43.5	11	5	46	3.2
80	40 to 100	95	63.5	33.5	20	53.5	13	7	59	4.5
100	40 to 100	111	76	42	22	53.5	13	7	71	6

Bore size (mm)	LX	LY	LZ	X	Y
63	95	91.5	113	16.2	9
80	118	114	140	19.5	11
100	137	136	162	23	12.5

Foot bracket material: Carbon steel  
Surface treatment: Nickel plated

### Compact foot type: RQLC/RDQLC

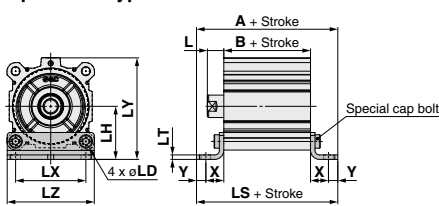

Rod end male thread

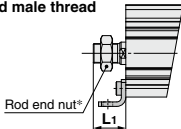

### Compact Foot Type

Bore size (mm)	Stroke range (mm)	A	B	LS	L	L1	LD	LH	LT
63	30 to 100	109.4	55	91.4	18	43.5	11	46	3.2
80	40 to 100	130.5	63.5	108.5	20	53.5	13	59	4.5
100	40 to 100	149	76	124	22	53.5	13	71	6

Bore size (mm)	LX	LY	LZ	X	Y
63	60	91.5	77	18.2	9
80	77	114	98	22.5	11
100	94	136	117	24	12.5

Foot bracket material: Carbon steel  
Surface treatment: Zinc chromated

### Rod side flange type: RQF/RDQF

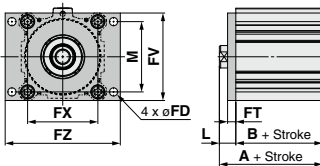

Rod end male thread

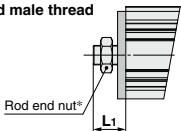

### Rod Side Flange Type

Bore size (mm)	Stroke range (mm)	A	B	FD	FT	FV	FX	FZ	L	L1	M
63	30 to 100	73	55	9	9	80	92	108	18	43.5	60
80	40 to 100	83.5	63.5	11	11	99	116	134	20	53.5	77
100	40 to 100	98	76	11	11	117	136	154	22	53.5	94

Flange bracket material: Carbon steel  
Surface treatment: Nickel plated



## Mounting Bracket Dimensions

### Head side flange type: RQG/RDQG

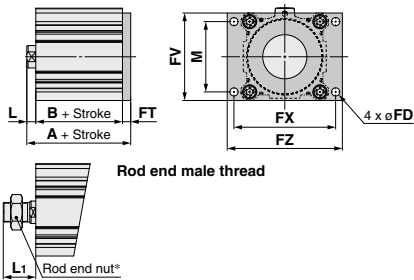

### Head Side Flange Type

Bore size (mm)	Stroke range (mm)	A	L	L <sub>1</sub>
63	30 to 100	72	8	33.5
80	40 to 100	84.5	10	43.5
100	40 to 100	99	12	43.5

\* All dimensions but A, L and L<sub>1</sub> are identical to those of the rod side flange type. Flange bracket material: Carbon steel  
Surface treatment: Nickel plated

### Double clevis type: RQD/RDQD

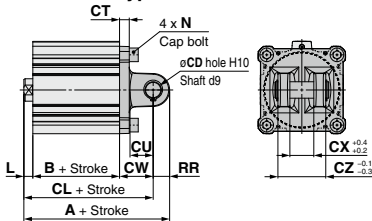

### Double Clevis Type

Bore size (mm)	Stroke range (mm)	A	B	CL	CD	CT	CU	CW	CX	CZ	L
63	30 to 100	107	55	93	14	8	20	30	22	44	8
80	40 to 100	129.5	63.5	111.5	18	10	27	38	28	56	10
100	40 to 100	155	76	133	22	13	31	45	32	64	12

Bore size (mm)	L <sub>1</sub>	N	RR
63	33.5	M10 x 1.5	14
80	43.5	M12 x 1.75	18
100	43.5	M12 x 1.75	22

\* Double clevis pins and retaining rings are included in the package.  
\* Refer to page 1052 for details on rod end nut and accessories.

Double clevis bracket material: Cast iron  
Surface treatment: Painted

# Accessory Bracket Dimensions

## Single Knuckle Joint

For I-G02, I-G03

For I-G04, I-G05  
I-G08, I-G10

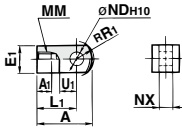

Material: Carbon steel  
Surface treatment: Nickel plated

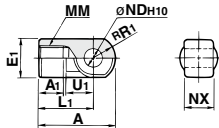

Material: Cast iron  
Surface treatment: Nickel plated

## Double Knuckle Joint

For Y-G02, Y-G03

For Y-G04, Y-G05  
Y-G08, Y-G10

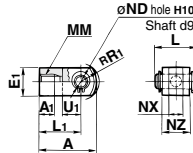

Material: Carbon steel  
Surface treatment: Nickel plated

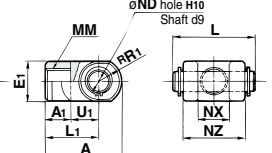

Material: Cast iron  
Surface treatment: Nickel plated

Part no.	Applicable bore size (mm)	A	A1	E1	L1	MM	R <sub>R1</sub>	U1	ND	NX
I-G02	20	34	8.5	□16	25	M8 x 1.25	10.3	11.5	8 <sup>+0.058</sup> <sub>0</sub>	8 <sup>-0.2</sup> <sub>-0.4</sub>
I-G03	25	41	10.5	□20	30	M10 x 1.25	12.8	14	10 <sup>+0.058</sup> <sub>0</sub>	10 <sup>-0.2</sup> <sub>-0.4</sub>
I-G04	32, 40	42	14	ø22	30	M14 x 1.5	12	14	10 <sup>+0.058</sup> <sub>0</sub>	18 <sup>-0.3</sup> <sub>-0.5</sub>
I-G05	50, 63	56	18	ø28	40	M18 x 1.5	16	20	14 <sup>+0.070</sup> <sub>0</sub>	22 <sup>-0.3</sup> <sub>-0.5</sub>
I-G08	80	71	21	ø38	50	M22 x 1.5	21	27	18 <sup>+0.070</sup> <sub>0</sub>	28 <sup>-0.3</sup> <sub>-0.5</sub>
I-G10	100	79	21	ø44	55	M26 x 1.5	24	31	22 <sup>+0.084</sup> <sub>0</sub>	32 <sup>-0.3</sup> <sub>-0.5</sub>

Part no.	Applicable bore size (mm)	A	A1	E1	L1	MM	R <sub>R1</sub>	U1	ND	NX	NZ	L	Applicable pin no.
Y-G02	20	34	8.5	□16	25	M8 x 1.25	10.3	11.5	8 <sup>+0.058</sup> <sub>0</sub>	8 <sup>-0.4</sup> <sub>-0.2</sub>	16	21	IY-G02
Y-G03	25	41	10.5	□20	30	M10 x 1.25	12.8	14	10 <sup>+0.058</sup> <sub>0</sub>	10 <sup>-0.2</sup> <sub>-0.4</sub>	20	23	IY-G03
Y-G04	32, 40	42	16	ø22	30	M14 x 1.5	12	14	10 <sup>+0.058</sup> <sub>0</sub>	18 <sup>-0.3</sup> <sub>-0.5</sub>	36	41	IY-G04
Y-G05	50, 63	56	20	ø28	40	M18 x 1.5	16	20	14 <sup>+0.070</sup> <sub>0</sub>	22 <sup>-0.3</sup> <sub>-0.5</sub>	44	51	IY-G05
Y-G08	80	71	23	ø38	50	M22 x 1.5	21	27	18 <sup>+0.070</sup> <sub>0</sub>	28 <sup>-0.3</sup> <sub>-0.5</sub>	56	64	IY-G08
Y-G10	100	79	24	ø44	55	M26 x 1.5	24	31	22 <sup>+0.084</sup> <sub>0</sub>	32 <sup>-0.3</sup> <sub>-0.5</sub>	64	72	IY-G10

\* Knuckle pin and retaining ring are included.

## Knuckle Pin (Common with double clevis pin)

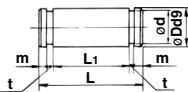

Material: Carbon steel  
mm

Part no.	Applicable bore size (mm)	D	L	d	L1	m	t	Retaining ring
IY-G02	20	8 <sup>-0.040</sup> <sub>-0.076</sub>	21	7.6	16.2	1.5	0.9	C8 type for pivot
IY-G03	25	10 <sup>-0.040</sup> <sub>-0.076</sub>	25.6	9.6	20.2	1.55	1.15	C10 type for pivot
IY-G04	32, 40	10 <sup>-0.040</sup> <sub>-0.076</sub>	41.6	9.6	36.2	1.55	1.15	C10 type for pivot
IY-G05	50, 63	14 <sup>-0.050</sup> <sub>-0.093</sub>	50.6	13.4	44.2	2.05	1.15	C14 type for pivot
IY-G08	80	18 <sup>-0.050</sup> <sub>-0.093</sub>	64	17	56.2	2.55	1.35	C18 type for pivot
IY-G10	100	22 <sup>-0.065</sup> <sub>-0.117</sub>	72	21	64.2	2.55	1.35	C22 type for pivot

\* Type C retaining rings for axis are included.

## Rod End Nut

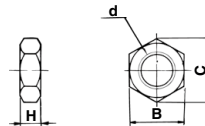

Material: Carbon steel  
Surface treatment: Zinc chromated  
mm

Part no.	Applicable bore size (mm)	d	H	B	C
NT-02	20	M8 x 1.25	5	13	15.0
NT-03	25	M10 x 1.25	6	17	19.6
NT-04	32, 40	M14 x 1.5	8	22	25.4
NT-05	50, 63	M18 x 1.5	11	27	31.2
NT-08	80	M22 x 1.5	13	32	37.0
NT-10	100	M26 x 1.5	16	41	47.3

## Simple Joint (RQ): $\phi 20$ to $\phi 100$

### Joint/Mounting Bracket (Type A/B) Part Nos.

Bore size (mm)	Joint	Type A mounting bracket	Type B mounting bracket
20	YU-020	YA-020	YB-020
25	YU-025	YA-025	YB-025
32, 40	YU-03	YA-03	YB-03
50, 63	YU-05	YA-05	YB-05
80	YU-08	YA-08	YB-08
100	YU-10	YA-10	YB-10

<Ordering>

- Joints are not included with type A or B mounting brackets. Order them separately.

(Example)

- Bore size  $\phi 40$  Part no.
- Type A mounting bracket ..... YA-03
- Joint ..... YU-03

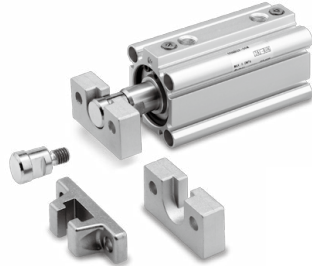

### Allowable Eccentricity

(mm)

Bore size (mm)	20	25	32	40	50	63	80	100
Eccentricity tolerance	$\pm 0.5$			$\pm 1$			$\pm 1.5$	$\pm 2$
Axial direction backlash				0.5				

### Type A Mounting Bracket

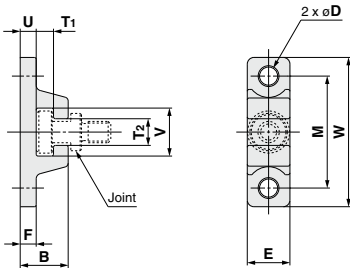

Material: Chromium molybdenum steel (Nickel plating) (mm)

Bore size (mm)	Part no.	B	D	E	F	M	T <sub>1</sub>	T <sub>2</sub>
20	YA-020	12	4.5	13	5	30	3.5	6
25	YA-025	12.5	5.5	15	5	33	3.5	7
32, 40	YA-03	18	6.8	16	6	42	6.5	10
50, 63	YA-05	20	9	20	8	50	6.5	12
80	YA-08	26	11	25	10	62	8.5	16
100	YA-10	31	14	30	12	76	10.5	18

Bore size (mm)	Part no.	U	V	W	Weight (g)
20	YA-020	5	13.5	42	27
25	YA-025	5	16.5	45	34
32, 40	YA-03	6	18	56	55
50, 63	YA-05	8	22	67	100
80	YA-08	10	28	83	195
100	YA-10	12	36	100	340

### Type B Mounting Bracket

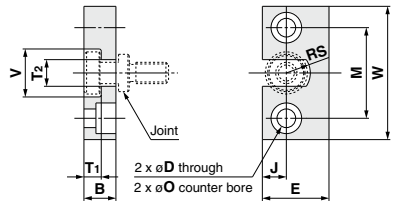

Material: Stainless steel (mm)

Bore size (mm)	Part no.	B	D	E	J	M	O
20	YB-020	7	4.5	18	7	25.5	—
25	YB-025	7.5	5.5	20	8	28	—
32, 40	YB-03	12	7	25	9	34	11.5 depth 7.5
50, 63	YB-05	12	9	32	11	42	14.5 depth 8.5
80	YB-08	16	11	38	13	52	18 depth 12
100	YB-10	19	14	50	17	62	21 depth 14

Bore size (mm)	Part no.	T <sub>1</sub>	T <sub>2</sub>	V	W	RS	Weight (g)
20	YB-020	3.5	6	13.6	36	3	28
25	YB-025	3.5	7	16.6	40	3.5	36
32, 40	YB-03	6.5	10	18	50	9	80
50, 63	YB-05	6.5	12	22	60	11	120
80	YB-08	8.5	16	28	75	14	230
100	YB-10	10.5	18	36	90	18	455

# RQ Series

## Joint

YU-020, YU-025

YU-03, YU-05  
YU-08, YU-10

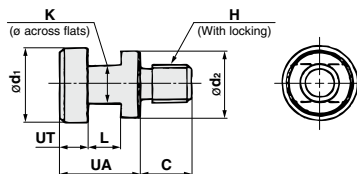
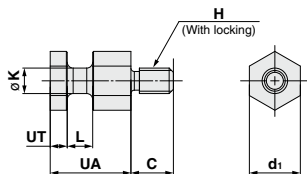

Material: Chromium molybdenum steel (Nickel plating)

Applicable bore size (mm)	Part no.	UA	C	$d_1$	$d_2$	H	K	L	UT	Weight (g)
20	YU-020	11.5	6	10	—	M5 x 0.8	5	4	3	7
25	YU-025	12	11	12	—	M6 x 1.0	6	4.5	3	10
32, 40	YU-03	17	11	15.8	14	M8 x 1.25	8	7	6	25
50, 63	YU-05	17	13	19.8	18	M10 x 1.5	10	7	6	40
80	YU-08	22	20	24.8	23	M16 x 2	13	9	8	90
100	YU-10	26	26	29.8	28	M20 x 2.5	14	11	10	160



# Auto Switch Mounting 1

## Minimum Auto Switch Mounting Stroke

No. of auto switch mounted	D-M9□ D-M9□V	D-M9□A D-M9□AV	D-A7□/A80 D-A73C/A80C	D-F7□V D-J79C	D-A79W	D-F7□W D-J79W	D-F7NT D-F79F	D-P3DWA
	D-M9□WV	D-A9□ D-A9□V	D-A7□H/A80H D-F7□/J79	D-F7□WV D-F7BAV		D-F7BA		
1 pc.	15	15	15	15	15	20 (15)	20	15
2 pcs.	15	15	15	15	20	20	20	15

Note) The dimension stated in ( ) shows the minimum mountable stroke when the auto switch does not project from the end face of the cylinder body and the lead wire bending space is not hindered. (Refer to the figure on the right.) Order auto switches and auto switch mounting brackets separately.

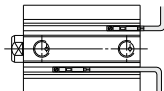

## Proper Auto Switch Mounting Position (Detection at stroke end) and Its Mounting Height

ø20/ø25

D-M9□  
D-M9□W  
D-M9□A  
D-A9□

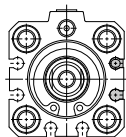

D-M9□V  
D-M9□WV  
D-M9□AV  
D-A9□V

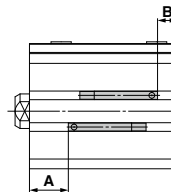
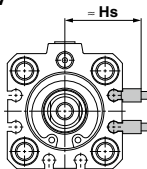

ø32 to ø100

D-M9□  
D-M9□W  
D-M9□A  
D-A9□

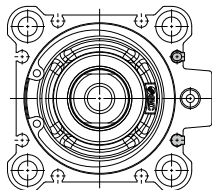

D-M9□V  
D-M9□WV  
D-M9□AV  
D-A9□V

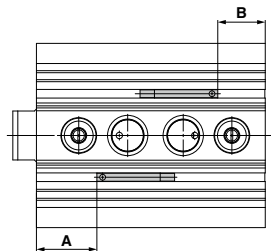
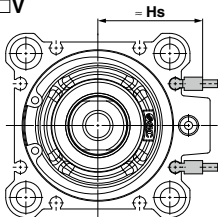

## Proper Auto Switch Mounting Positions (mm)

Auto switch model	D-M9□ D-M9□V D-M9□W		D-M9□WV D-M9□A D-M9□AV		D-A9□ D-A9□V	
	A	B	A	B	A	B
Bore size 20	13.5	7	9.5	3		
25	15	9.5	11	5.5		
32	16.5	8.5	12.5	4.5		
40	21	11	17	7		
50	21	16.5	17	12.5		
63	23.5	19.5	19.5	15.5		
80	28.5	23	24.5	19		
100	35	29	31	25		

## Auto Switch Mounting Height (mm)

Auto switch model	D-M9□V D-M9□WV D-M9□AV		D-A9□V
	Hs	Hs	Hs
Bore size 20	24.5	22.5	
25	26.5	24.5	
32	30	27.5	
40	32	30	
50	37.5	35	
63	42.5	40.5	
80	51	49	
100	59	57	

Note) Adjust the auto switch after confirming the operating condition in the actual setting.

**Proper Auto Switch Mounting Position (Detection at stroke end) and Its Mounting Height**

ø32 to ø100

- D-A7□
- D-A80
- D-A7□H
- D-A80H
- D-F7□
- D-J79
- D-F7□W
- D-J79W
- D-F79F
- D-F7NT
- D-F7BA
- D-A73C
- D-A80C
- D-J79C
- D-A79W
- D-F7□V
- D-F7□WV
- D-F7BAV

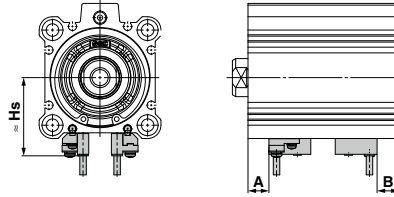

ø25

D-P3DWA

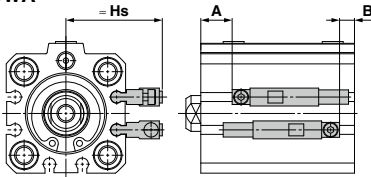

ø32 to ø100

D-P3DWA

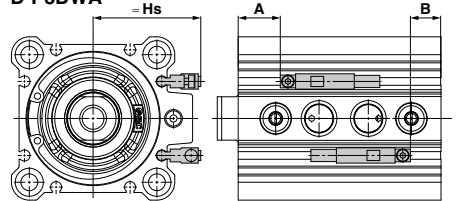

**Proper Auto Switch Mounting Position**

(mm)

Auto switch model	D-A73 D-A80		D-A72/A7□H D-A80H/A73C D-A80C/F7□ D-F7□V/F79F D-J79/J79C D-F7□W D-F7□WV D-J79W D-F7BA D-F7BAV		D-A79W		D-F7NT		D-P3DWA	
	A	B	A	B	A	B	A	B	A	B
Bore size										
20	—	—	—	—	—	—	—	—	—	—
25	—	—	—	—	—	—	—	—	10.5	5
32	13.5	5.5	14	6	11	3	19	11	12	4
40	18	8	18.5	8.5	15.5	5.5	23.5	13.5	16.5	6.5
50	18	13.5	18.5	14	15.5	11	23.5	19	16.5	12
63	20.5	16.5	21	17	18	14	26	22	19	15
80	25.5	20	26	20.5	23	17.5	31	25.5	24	18.5
100	32	26	32.5	26.5	29.5	23.5	37.5	31.5	30.5	24.5

**Auto Switch Mounting Height**

(mm)

Auto switch model	D-A7□ D-A80	D-F7□ D-J79 D-F79W D-F7BA D-F79F	D-F7□V D-F7□WV	D-J79C	D-A73C D-A80C	D-A79W	D-P3DWA
	Hs	Hs	Hs	Hs	Hs	Hs	Hs
Bore size							
20	—	—	—	—	—	—	—
25	—	—	—	—	—	—	33
32	34	36	36.5	39.5	40.5	37.5	35.5
40	37.5	38	40	42.5	43.5	40.5	38
50	43	43.5	45	48	49	46	43
63	48	48.5	50.5	53.5	54.5	51.5	48
80	56.5	57	59	61.5	62.5	49.5	56.5
100	64.5	65.5	67	70	71	68	65

Note 1) Adjust the auto switch after confirming the operating condition in the actual setting.

**Operating Range**

(mm)

Auto switch model	Bore size							
	20	25	32	40	50	63	80	100
D-M9□/M9□V D-M9□W/M9□WV D-M9□A/M9□AV	5.5	6	6	6	7	9.5	10	11
D-A9□/A9□V	10	10	9.5	9.5	9.5	11.5	9	11.5
D-A7□/A80 D-A7□H/A80H D-A73C/A80C	—	—	12	11	10	12	12	13
D-A79W	—	—	6	14	14	16	15	17
D-F7□/F7□V D-J79/J79C/J79W D-F7□W/F7□WV D-F79F/F7BA D-F7BAV/F7NT	—	—	13	6	6	6.5	6.5	7
D-P3DWA	—	6	6	6	6	8.5	9	9

\* Since the operating range is provided as a guideline including hysteresis, it cannot be guaranteed (assuming approximately ±30% dispersion). It may vary substantially depending on an ambient environment.

# Auto Switch Mounting 2

## Auto Switch Mounting Bracket/Part No.

Applicable auto switch	D-M9□/M9□V D-M9□W/M9□VW D-M9□A/M9□AV D-A9□/A9□V	D-F7□/F7□V/J79/J79C/F7□W/J79W/F7□WV D-F7BA/F7BAV/F79F/F7NT D-A7□/A80/A7□H/A80H/A73C/A80C/A79W	D-P3DWA											
Bore size (mm)	ø20 to ø100	ø32 to ø100 BQ5-032	ø25 to ø100											
Auto switch mounting bracket part no.	—	—	—											
Auto switch mounting bracket fitting parts lineup/Weight	—	<ul style="list-style-type: none"> <li>Auto switch fixing screw (M2.5 x 10 L)</li> <li>Auto switch mounting screw (M3 x 8 L)</li> <li>Auto switch spacer</li> <li>Auto switch mounting nut Weight: 3.5 g</li> </ul>	—											
Auto switch mounting surface	Surfaces with auto switch mounting slot ø20, ø25 Port side	A/B/C side except port side	Surfaces with auto switch mounting slot											
Mounting of auto switch	<p>Auto switch mounting screw</p> <p>Auto switch</p> <p>• When tightening an auto switch mounting screw, use a watchmaker's screwdriver with a handle diameter of 5 to 6 mm.</p> <p><b>Tightening torque for auto switch mounting screw</b> [N.m]</p> <table border="1"> <thead> <tr> <th>Auto switch model</th> <th>Tightening torque</th> </tr> </thead> <tbody> <tr> <td>D-M9□(V)</td> <td rowspan="2">0.05 to 0.15</td> </tr> <tr> <td>D-M9□W(V)</td> </tr> <tr> <td>D-A93</td> <td rowspan="2">0.05 to 0.10</td> </tr> <tr> <td>D-M9□A(V)</td> </tr> <tr> <td>D-A9□(V)</td> <td rowspan="2">0.10 to 0.20</td> </tr> <tr> <td>(Excludes the D-A93)</td> </tr> </tbody> </table>	Auto switch model	Tightening torque	D-M9□(V)	0.05 to 0.15	D-M9□W(V)	D-A93	0.05 to 0.10	D-M9□A(V)	D-A9□(V)	0.10 to 0.20	(Excludes the D-A93)	<ol style="list-style-type: none"> <li>Insert the nut into the auto switch mounting slot on the cylinder tube, and place it in the roughly estimated setting position.</li> <li>With the lower tapered part of the auto switch spacer facing the outside of the cylinder tube, line up the M2.5 through hole with the M2.5 female thread of the auto switch mounting nut.</li> <li>Gently screw the auto switch mounting nut fixing screw (M2.5) into the thread of the auto switch mounting nut through the mounting hole.</li> <li>Engage the ridge on the auto switch mounting arm with the recess in the auto switch spacer.</li> <li>Tighten the auto switch mounting screw (M3) to fix the auto switch. The tightening torque of the M3 screw must be 0.35 to 0.45 N·m.</li> <li>Confirm where the mounting position is, and tighten the auto switch fixing screw (M2.5) to fix the auto switch mounting nut. The tightening torque of the M2.5 screw must be 0.25 to 0.35 N·m.</li> <li>The detection position can be changed under the conditions in step (5).</li> </ol>	<ol style="list-style-type: none"> <li>Insert the mounting bracket into the mating groove of the cylinder tube.</li> <li>Check the detecting position of the auto switch and fix the auto switch firmly with the hexagon socket head cap screw (M2.5 x 12 L).</li> <li>If the detecting position is changed, go back to step (1).</li> </ol> <ul style="list-style-type: none"> <li>Ensure that the auto switch is covered with the mating groove to protect the auto switch.</li> <li>The tightening torque for the hexagon socket head cap screw (M2.5 x 12 L) is 0.2 to 0.3 N·m.</li> </ul> <p>(Included with auto switch) Hexagon socket head cap screw (M2.5 x 12 L)</p>
	Auto switch model	Tightening torque												
D-M9□(V)	0.05 to 0.15													
D-M9□W(V)														
D-A93	0.05 to 0.10													
D-M9□A(V)														
D-A9□(V)	0.10 to 0.20													
(Excludes the D-A93)														

\* Auto switch mounting bracket and auto switch are enclosed with the cylinder for shipment.

For an environment that needs the water-resistant auto switch, select the D-M9□A(V) type.

Auto switch mounting bracket for the D-F7BA(V) type uses BQ4-012 and BQ5-032 normal specifications (metal screw).

\* D-A7/A8/F7/J7 types cannot be mounted on ø20 and ø25.

### [Stainless Steel Mounting Screw Kit]

The following stainless steel mounting screw kit (with nuts) is available. Use it in accordance with the operating environment. (Since auto switch spacer (for BQ-2) is not included, order BQ-2 separately.)

BBA2: For D-A7/A8/F7/J7 types

The above stainless steel screws are used when a cylinder is shipped with the D-F7BA/F7BAV auto switches.

When only one auto switch is shipped independently, the BBA2 is attached.

\* Refer to the **Web Catalog** for details on the BBA2.

Other than the applicable auto switches listed in "How to Order", the following auto switches can be mounted.

### Other Applicable Auto Switches

Refer to pages 1271 to 1365 for further information on auto switches.

Type	Model	Electrical entry (Fatching direction)	Features	Type	Model	Electrical entry (Fatching direction)	Features
Reed auto switch	D-A73, A72	Grommet (Perpendicular)	Without indicator light	Solid state auto switch	D-F7NV, F7PV, F7BV	Grommet (Perpendicular)	Diagnostic indication (2-color indicator) Water resistance (2-color indicator)
	D-A80	Grommet (In-line)	Without indicator light Diagnostic indication (2-color indicator)		D-F7NWW, F7BWV	Grommet (In-line)	Diagnostic indication (2-color indicator) Water resistance (2-color indicator)
	D-A73H, A72H, A76H	Connector (Perpendicular)	Without indicator light		D-F79V, F7P, J79		
	D-A80H	Without indicator light	D-F79W, F7PW, J79W				
	D-A80C	Without indicator light	D-F7BA				
	D-A79W	Without indicator light	D-F7NT		With timer		
D-A73C	Without indicator light	D-F79F	With diagnostic output (2-color indicator)				
D-A80C	Without indicator light	D-J79C	Connector (Perpendicular)				

\* For solid state auto switches, auto switches with a pre-wired connector are also available. Refer to pages 1340 and 1341 for details.

\* Normally closed (NC = b contact) solid state auto switches (D-M9□E(V)) are also available. Refer to page 1290 for details.

\* D-A7/A8/F7/J7 types cannot be mounted on ø20 and ø25.





# RQ Series

## Specific Product Precautions

Be sure to read this before handling the products.

Refer to page 20 for safety instructions and pages 21 to 30 for actuator and auto switch precautions.

### Installation and Removal of Retaining Ring

#### ⚠ Caution

1. Use appropriate pliers (Type C retaining ring installing tool) for installation and removal.
2. Even when using appropriate pliers (Type C retaining ring installing tool), proceed with caution as there is a danger of the retaining ring flying off the end of the pliers (Type C retaining ring installing tool) and causing human injury or damage to nearby equipment. After installation, confirm that the retaining ring is securely seated into the retaining ring groove before supplying air.

### Selection

#### ⚠ Caution

1. Operate the cylinder to the stroke end.  
When the stroke is restricted by an external stopper or a clamped work piece, satisfactory cushioning and noise reduction may not be achieved.
  2. Strictly observe the limiting ranges for load mass and maximum speed (Graph (1)). Also, the limiting ranges are based on operation of the cylinder to the stroke end and proper adjustment of the cushion needle.
- If operated beyond the limiting ranges, excessive impact will occur and this may cause damage to equipment.

Graph (1)

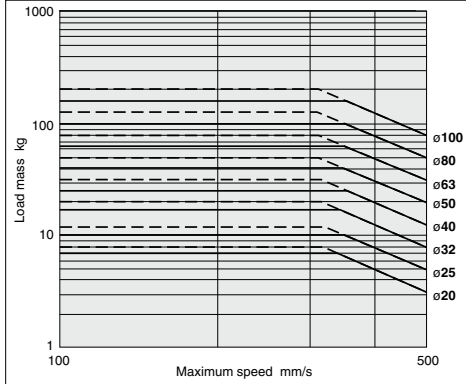

3. Adjust the cushion needle to reduce excessive kinetic energy from the piston impact at the stroke end by absorbing enough kinetic energy during the cushion stroke.

If the piston impacts the stroke end with excessive kinetic energy (values in Table 1 or more), an excessive impact will occur and this may cause damage to equipment.

Table (1) Allowable Kinetic Energy At Piston Impact Unit: [J]

Piston speed	20	25	32	40	50	63	80	100
Allowable kinetic energy	0.055	0.09	0.15	0.26	0.46	0.77	1.30	2.27

### Selection

#### ⚠ Caution

4. Strictly observe the limiting ranges for the piston rod lateral load (Graph (2)).

If operated beyond the limiting ranges, this may cause the equipment life to be reduced or damage to equipment may occur.

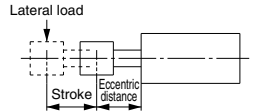

Graph (2)

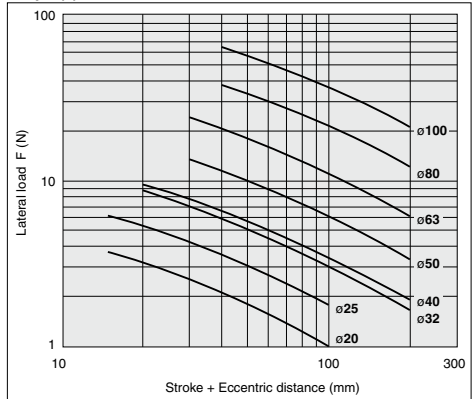

### Cushion Needle Adjustment

#### ⚠ Caution

1. Readjust with a Cushion Needle

When the product is shipped, the cushion needle is open 1/4 to 1/2 turn from the fully closed position. Readjust the position depending on the load or operating speed before using.

Note that the needle must be fully closed first, and then gradually reopened when adjusting.

2. Keep the adjustment range for the cushion needle between the closed position and the rotations shown below.

	Rotations
ø20 to ø100	2.5 rotations or less

Use a 3 mm flat head watchmakers screw driver to adjust the cushion needle. The adjustment range for the cushion needle must be between the closed position and the open position ranges above. A retaining mechanism prevents the cushion needle from coming out, however, it may spring out during operation if it is rotated beyond the ranges shown above.