

High Power Cylinder

RHC Series

ø20, ø25, ø32, ø40, ø50, ø63, ø80, ø100

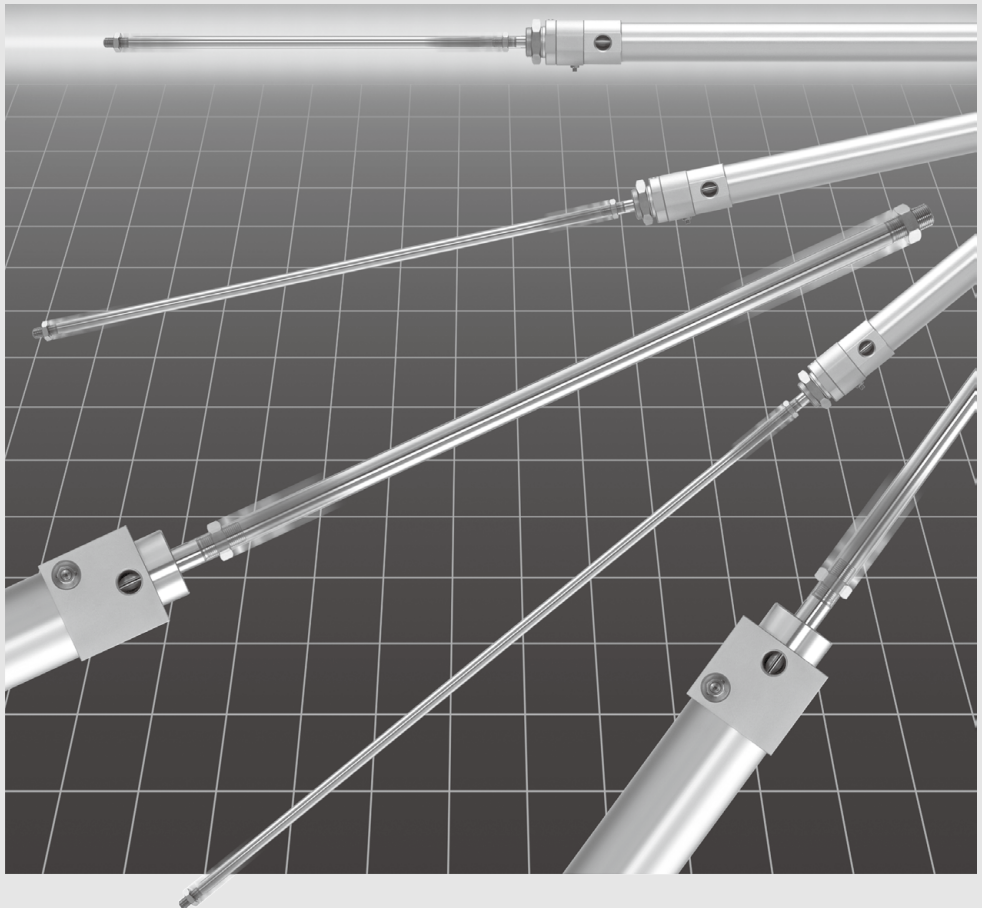

High power cylinder:

Smooth cushioning for high speed operation (3000 low/medium speed operation with heavy loads

The capacity to absorb 10 to 20 times more energy than general purpose cylinders.

Supply/Exhaust port

The diameter of the port orifice has been enlarged to support high speed operation.

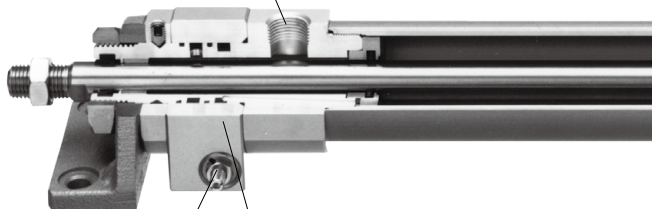
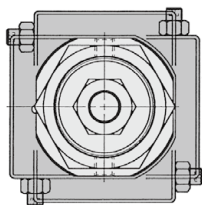

Relief valve adjusting screw

Relief valve body

The relief valve body rotates 360°, enabling relief adjustment from any direction. (ø20, ø25, ø32, ø40)

Mounting and Cushion Adjustment

Piping/mounting man-hours are the same as that of the general purpose cylinders.

Cushion adjustment (relief adjustment) man-hours are the same as the adjustment (cushion needle adjustment) for general purpose cylinders.

Quality of Cushioning (RHCF40-500, Load mass 5 kg, Supply pressure 0.5 MPa, Horizontal operation)

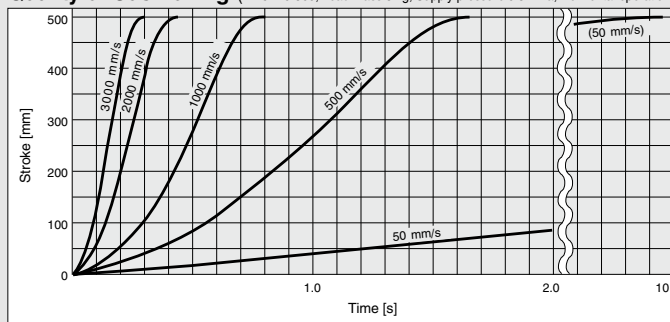

Cushion Capacity

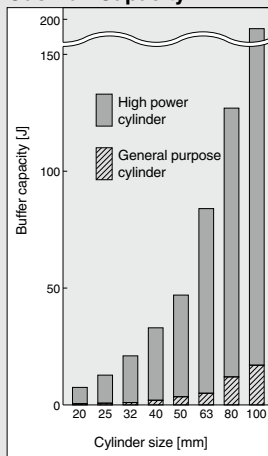

RHC Series

mm/s) with light loads and



Cushion ring

The long cushion ring can absorb larger energy (in terms of speed and weight).

Cushion seal

Strong seals are used for improved high speed durability and cushioning performance.



Relief valve

The relief valve is used as a cushion valve and it provides better cushioning performance than a needle throttle of a general purpose cylinder.

Working Principle

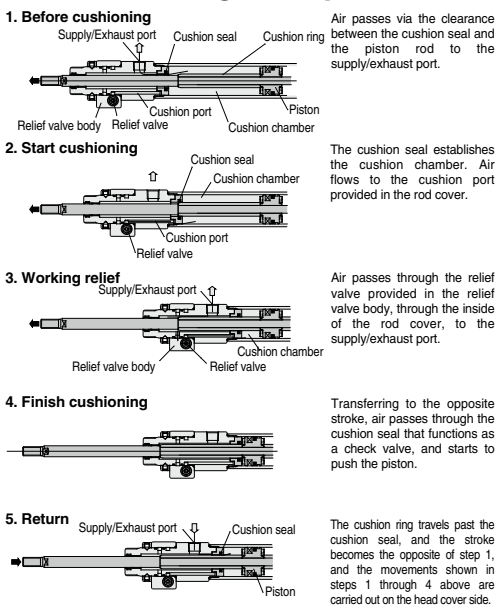

Application Examples

Opening/closing doors
(2000 mm/s, several tens kg)

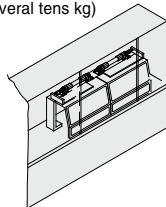

High speed Z-axis
(Up to 3000 mm/s, several kg)

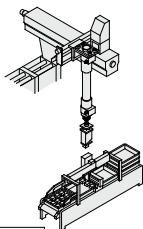

Transfer equipment
40 kg, 1000 mm/s (For $\phi 32$)

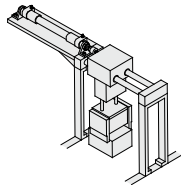

RHC Series Model Selection

Model Selection Example of High Power Cylinder

Selection Example 1.

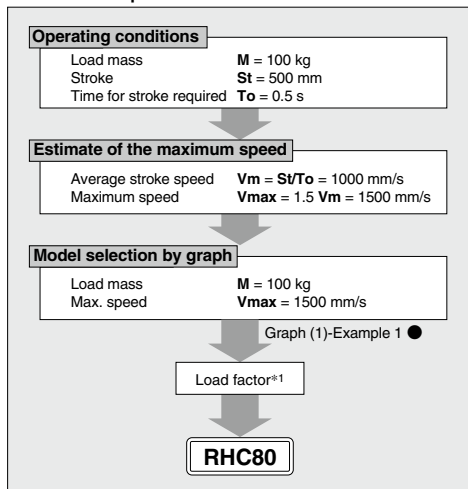

Graph (1) Allowable Kinetic Energy Graph

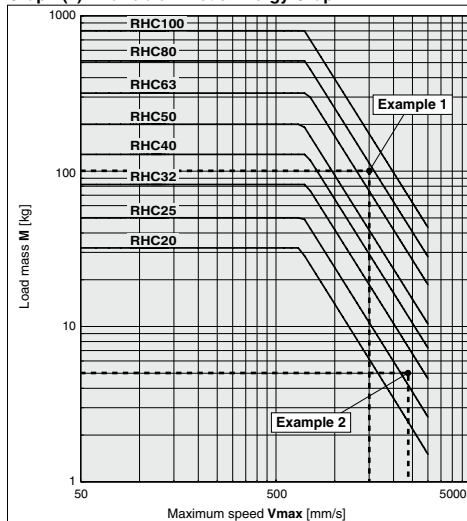

*1 Use an external guide, etc. for horizontal actuation of a load.

* Be sure to confirm the load factor with the RHC theoretical output table and the "Air Cylinder Model Selection" section in the **Web Catalog**.

Selection Example 2.

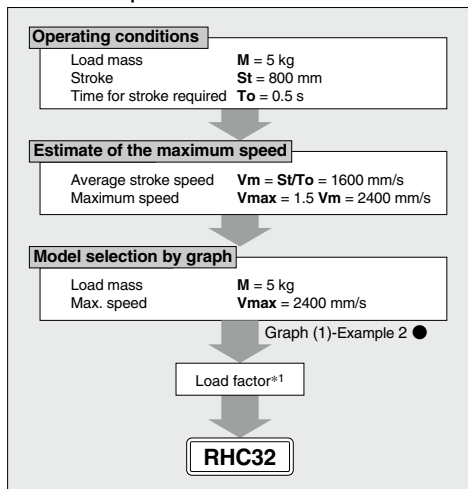

*1 Use an external guide, etc. for horizontal actuation of a load.

* Be sure to confirm the load factor with the RHC theoretical output table and the "Air Cylinder Model Selection" section in the **Web Catalog**.

Maximum Energy Absorption

Bore size (mm)	20	25	32	40	50	63	80	100
Maximum energy absorption (J)	7	12	21	33	47	84	127	196

RHC Series System Selection

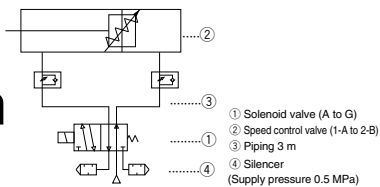

System Selection

Apply η (cylinder load ratio) and V_{max} (max. speed) and determine effective sectional area "So".

Refer to "System Selection" table, and the appropriate solenoid valve, speed control valve and bore size may be selected.

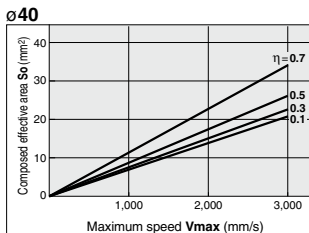
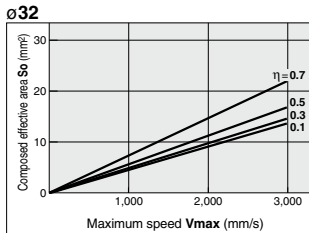
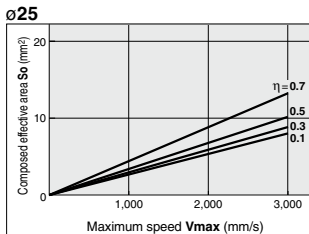
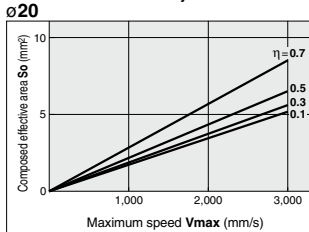

η : Cylinder load ratio

V_{max} : Maximum speed (Refer to page 362.)

Bore size (mm)	Maximum speed (mm/s)	Solenoid valve (), Effective area (mm ²)					Speed controller				Tubing O.D. (mm) Steel piping size
		A	B	C	D	E	Speed controller				
		3.6 to 6.3	9.0 to 14.4	16.2 to 21.6	36 to 45	64.8 to 67					
		VO1000 (3.6)	VO2000 (14.4)	—	VO4000 (36.0)	—					
		VO1000 (5.4)	—	VO2000 (16.2)	—	—					
		SY3000 (5.4)	SY5000 (12.6)	SY7000 (21.6)	—	—					
		SX3000 (5.4)	SX5000 (12.6)	SX7000 (21.6)	—	—					
		SYJ5000 (4.5)	SYJ7000 (12.6)	—	—	—					
		VOZ1000 (3.6)	VOZ2000 (12.6)	VOZ3000 (16.2)	—	—					
		VOZ1000 (6.3)	VOZ2000 (12.6)	VOZ3000 (21.6)	—	—					
		—	—	VFR2000 (16.2)	VFR3000 (41.4)	VFR4000 (67.0)					
		—	VFS1000 (9.0)	VFS2000 (18.0)	VFS3000 (36.0)	VFS4000 (64.5)					
		—	—	—	—	—					
20	500	1.5					1-A	AS22□1F (3.5)	1/8, 1/4	ø6	
							1-B	AS23□1F (3.5)			
							1-C	AS2051F (4.5)			
	1000	3						2-A	AS22□0 (2.9)	1/4, 3/8	ø6
								2-B	AS2000 (3.8)		
								1-C	AS3001F (6.5)		
	1500	4.5						2-B	AS3000, AS3500 (12.3)	ø10	
								1-C	AS4001F (16)		
								2-B	AS3000, AS3500 (12.3)		
	2000	6						1-C	AS4001F (16)	ø10	
								1-C	AS4001F (16)		
								2-B	AS3000, AS3500 (12.3)		
2500	7.5						1-C	AS3000, AS3500 (12.3)	ø10		
							1-C	AS4001F (16)			
							2-B	AS3000, AS3500 (12.3)			
3000	9						1-C	AS4001F (16)	ø10		
							1-C	AS4001F (16)			
							2-B	AS3000, AS3500 (12.3)			
25	500	2.5					1-C	AS2051F (4.5)	1/4, 3/8	ø6	
							1-C	AS3001F (10)			
	1000	5						2-B	AS3000, AS3500 (12.3)	1/4, 3/8	ø8
								1-C	AS4001F (16)		
	1500	7.5						1-C	AS4001F (16)	ø10	
								2-B	AS3000, AS3500 (12.3)		
2000	10						1-C	AS4001F (16)	ø10		
							2-B	AS4000 (25.5)			
2500	12.5						2-B	AS4000 (25.5)	1/4	ø10	
							2-B	AS4000 (25.5)			
32	500	4					1-A	AS32□1F (10)	1/4, 3/8	ø6	
							1-B	AS33□1F (10)			
							1-C	AS4001F (16)			
	1000	8						2-A	AS32□0 (13)	1/4, 3/8	ø10
								2-B	AS3000, AS3500 (12.3)		
								1-C	AS4001F (16)		
	1500	12						2-A	AS32□0 (13)	1/4, 3/8	ø10
								2-B	AS3000, AS3500 (12.3)		
								2-B	AS4000 (25.5)		
	2000	16						2-B	AS5000 (74)	3/8	ø10
								2-B	AS5000 (74)		
								2-B	AS5000 (74)		
2500	20						2-B	AS5000 (74)	3/8	ø10	
							2-B	AS5000 (74)			
							2-B	AS5000 (74)			
3000	24						2-B	AS5000 (74)	3/8	ø10	
							2-B	AS5000 (74)			
							2-B	AS5000 (74)			
40	500	6					1-A	AS32□1F (10)	1/4, 3/8	ø8	
							1-B	AS33□1F (10)			
							1-C	AS4001F (16)			
	1000	12						2-A	AS32□0 (13)	3/8, ø12	ø10
								2-B	AS3000, AS3500 (12.3)		
								2-B	AS4000 (25.5)		
1500	18						2-B	AS5000 (74)	3/8, ø12	ø10	
							2-B	AS5000 (74)			
							2-B	AS5000 (74)			
2000	24						2-B	AS5000 (74)	3/8, ø12	ø10	
							2-B	AS5000 (74)			
							2-B	AS5000 (74)			
2500	30						2-B	AS5000 (74)	3/8, ø12	ø10	
							2-B	AS5000 (74)			
							2-B	AS5000 (74)			
3000	36						2-B	AS420 (74)	3/8, ø12	ø10	
							2-B	AS420 (74)			
							2-B	AS420 (74)			

Note) Refer to page 366 for maximum absorbed energy since cushioning ability may in some cases exceed the allowable cushioning ability if the cylinder is used under high speeds and large loads.

Apply η (cylinder load ratio) and V_{max} (max. speed) and determine effective sectional area "So".

Refer to "System Selection" table, and the appropriate solenoid valve, speed control valve and bore size may be selected.

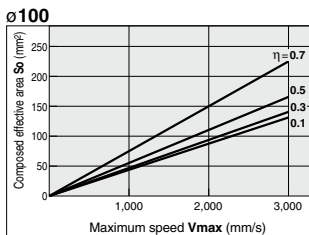
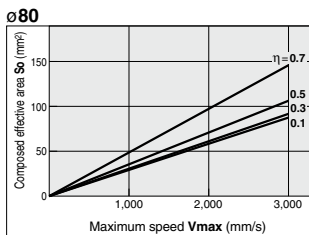
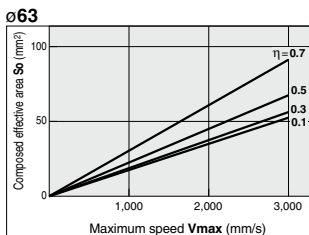
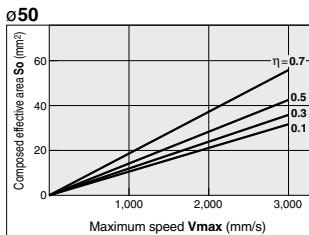

η : Cylinder load ratio

V_{max} : Maximum speed (Refer to page 362.)

System Selection

Bore size (mm)	Maximum speed (mm/s)	Composed effective area (mm ²)	Solenoid valve (): Effective area [mm ²]					Speed controller	Tubing I.D. (mm) Steel piping size	
			C 16.2 to 21.6	D 36 to 45	E 64.8 to 67	F 102.6 to 120	G 180 to 300			
50	9.5	VQ2000 (16.2)	—	—	—	—	—	Standard type With One-touch fittings	1-A Elbow type 1-B Universal type 1-C In-line type 2-A Metal elbow type 2-B In-line type	ø8, ø10 1/4
		SY7000 (21.6)	—	—	—	—	—			
		SX7000 (21.6)	—	—	—	—	—			
		VQ23000 (16.2)	—	—	—	—	—			
		VQ23000 (21.6)	—	—	—	—	—			
	1000	VFR2000 (16.2)	VFR3000 (41.4)	VFR4000 (67.0)	VFR5000 (102.6)	VFR6000 (191)	—	—	—	
		VFS2000 (18.0)	VFS3000 (38.0)	VFS4000 (64.5)	VFS5000 (12.6)	VFS6000 (180)	VPC150 (120)	VPC170 (300)	—	
		—	—	—	—	—	—	—	—	
		—	—	—	—	—	—	—	—	
		—	—	—	—	—	—	—	—	
63	15	—	—	—	—	—	—	—	ø12, ø16 1/4, 3/8	
		—	—	—	—	—	—	—		
		—	—	—	—	—	—	—		—
		—	—	—	—	—	—	—		—
		—	—	—	—	—	—	—		—
	500	1500	28.5	—	—	—	—	—		—
		2000	38	—	—	—	—	—		—
		2500	47	—	—	—	—	—		—
		3000	56.5	—	—	—	—	—		—
		—	—	—	—	—	—	—		—
80	24.5	—	—	—	—	—	—	—	ø16 3/8, 1/2	
		—	—	—	—	—	—	—		
		—	—	—	—	—	—	—		—
		—	—	—	—	—	—	—		—
		—	—	—	—	—	—	—		—
	1000	1000	30	—	—	—	—	—		—
		1500	45	—	—	—	—	—		—
		2000	60	—	—	—	—	—		—
		2500	75	—	—	—	—	—		—
		3000	89.5	—	—	—	—	—		—
100	38	—	—	—	—	—	—	—	3/4, ø16	
		—	—	—	—	—	—	—		
		—	—	—	—	—	—	—		—
		—	—	—	—	—	—	—		—
		—	—	—	—	—	—	—		—
	500	1000	48.5	—	—	—	—	—		—
		1500	72.5	—	—	—	—	—		—
		2000	96.5	—	—	—	—	—		—
		2500	120.5	—	—	—	—	—		—
		3000	106	—	—	—	—	—		—
1000	1000	75.5	—	—	—	—	—	—		
	1500	113	—	—	—	—	—	—		
	2000	110.5	—	—	—	—	—	—		
	2500	138	—	—	—	—	—	—		
	3000	88.5	—	—	—	—	—	—		

Note) Refer to page 366 for the maximum absorbed energy since cushioning ability may in some cases exceed the allowable cushioning ability if the cylinder is used under high speeds and large loads.

High Power Cylinder

RHC Series

ø20, ø25, ø32, ø40, ø50, ø63, ø80, ø100

How to Order

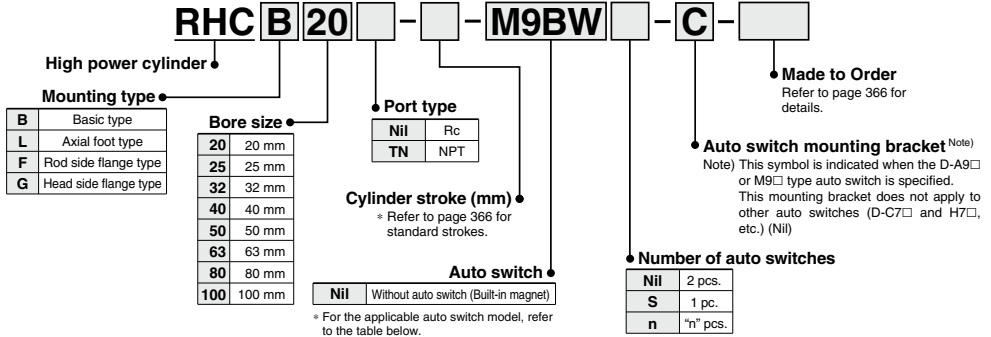

Applicable Auto Switches

Refer to pages 1341 to 1435 for further information on auto switches.

Type	Special function	Electrical entry	Indicator light	Wiring (Output)	Load voltage		Auto switch model				Lead wire length (m)				Pre-wired connector	Applicable load												
					DC	AC	Applicable bore size (mm)		0.5 (Nil)	1 (M)	3 (L)	5 (Z)	None (N)															
							ø20 to ø63	ø80, ø100																				
Solid state auto switch	—	Grommet	No	3-wire (NPN)	5 V, 12 V	—	M9NV	M9N	●	●	●	○	—	○	IC circuit	Relay, PLC												
									—	—	—	—	—	—														
				3-wire (PNP)	—	—	—	—	—	—																		
		Connector		2-wire	12 V	—	—	—	—	—	—	—	—	—	—		—											
																		Terminal conduit	3-wire (NPN)	5 V, 12 V	—	—	—	—	—	—	—	—
	Diagnostic indication (2-color indicator)	Grommet	Yes	3-wire (NPN)	24 V	5 V, 12 V	—	M9NV	M9N	●	●	●	○	—	○		IC circuit											
										3-wire (PNP)	—	—	—	—	—			—										
				Water resistant (2-color indicator)	2-wire	12 V	—	—	—	—	—	—	—	—	—		—	—										
		3-wire (NPN)																	5 V, 12 V	—	—	—	—	—	—	—		
																											3-wire (PNP)	—
		With diagnostic output (2-color indicator)		Grommet	Yes	4-wire (NPN)	5 V, 12 V	—	—	—	—	—	—	—	—		—	—										
—	—		—													—			—	—	—							
Reed auto switch	—	Grommet	No	3-wire (NPN equivalent)	5 V	—	A96V	A96	●	●	●	—	—	—	IC circuit	Relay, PLC												
									—	—	—	—	—	—			—											
				Connector	2-wire	24 V	12 V	—	—	—	—	—	—	—	—		—	—										
		Terminal conduit																	100 V	A93V*2	A93	—	—	—	—	—		
																											100 V or less	A90V
		DIN terminal		Grommet	Yes	—	—	—	—	—	—	—	—	—	—		—											
	100 V, 200 V		—															—	B54	●	●	●	—	—				
	Diagnostic indication (2-color indicator)	Grommet	No	3-wire (NPN equivalent)	5 V	—	—	—	—	—	—	—	—	—	—													
																	—	—	—	—	—	—	—					
				Water resistant (2-color indicator)	2-wire	12 V	—	—	—	—	—	—	—	—	—		—	—										
		3-wire (NPN)																	5 V, 12 V	—	—	—	—	—	—	—		
																											3-wire (PNP)	—
With diagnostic output (2-color indicator)		Grommet		Yes	4-wire (NPN)	5 V, 12 V	—	—	—	—	—	—	—	—	—	—												
	—		—														—	—	—	—	—							

*1 Water resistant type auto switches can be mounted on the above models, but in such case SMC cannot guarantee water resistance.
*2 1 m type lead wire is only applicable to D-A93.

* Lead wire length symbols: 0.5 m..... Nil (Example) M9NV
1 m..... M (Example) M9NWM
3 m..... L (Example) M9NWL
5 m..... Z (Example) M9NWZ
None..... Nil (Example) H7CN

* Solid state auto switches marked with "○" are produced upon receipt of order.
* D-A9□/M9□/M9□WV/D-M9□(A)V types cannot be mounted.
* Do not indicate suffix "N" for no lead wire on D-A3□/A4□/G39/K39 models.

* Since there are other applicable auto switches than listed, refer to page 378 for details.
* For details about auto switches with pre-wired connector, refer to pages 1410 and 1411.
* D-A9□/M9□/M9□W auto switches are shipped together (not assembled). (Only auto switch mounting brackets are assembled before shipped.)

RHC Series



Symbol

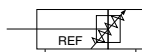

Made to Order
[Click here for details](#)

Symbol	Specification
-XC3	Special port location*
-XC6	Made of stainless steel
-XC93	Water resistance + Stable lubrication function**

* ø20 to ø40 only

** ø32, ø40 only

Specifications

Bore size (mm)	20	25	32	40	50	63	80	100
Fluid	Air							
Proof pressure	1.5 MPa							
Maximum operating pressure	1.0 MPa							
Minimum operating pressure	0.05 MPa							
Ambient and fluid temperature	-10 to 60°C (No freezing)							
Piston speed	50 to 3000 mm/s							
Cushion	Air cushion							
Maximum energy absorption (J)	7	12	21	33	47	84	127	196
Effective cushioning stroke (mm)	80	80	80	80	80	80	80	80
Lubrication	Not required (Non-lube)							
Stroke length tolerance	Up to 1000 st: $^{+1.4}_0$, 1001 to 1500 st: $^{+1.8}_0$							
Mounting	Basic type, Axial foot type, Rod/Head side flange type							

Stroke

Bore size (mm)	Minimum stroke (Recommended) ⁽¹⁾	Standard stroke ⁽²⁾	Max. stroke
20	250	up to 700	1500
25	250	up to 700	1500
32	250	up to 1000	1500
40	250	up to 1000	1500
50	250	up to 1200	1500
63	250	up to 1200	1500
80	250	up to 1400	1500
100	250	up to 1500	1500

Note 1) Strokes shorter than the recommended minimum stroke (1 to 249 st) can be manufactured, but cushion capability may not be satisfied since the effective cushion stroke for this cylinder is long.
 Note 2) Stroke exceeding the standard stroke length is not subject to the guarantee.

Mounting Bracket Part No.

Mounting bracket	Qty.	Bore size (mm)								Description
		20	25	32	40	50	63	80	100	
Axial foot	Note) 2	RHC-L020	RHC-L025	RHC-L032	RHC-L040	RHC-L050	RHC-L063	RHC-L080	RHC-L100	ø20 to ø40 : Foot x 2, Mounting nut x 1 ø50 to ø100: Foot x 2, Bracket mounting bolt x 8, Spring washer x 8
Flange	1	RHC-F020	RHC-F025	RHC-F032	RHC-F040	RHC-F050	RHC-F063	RHC-F080	RHC-F100	ø20 to ø40 : Flange x 1 ø50 to ø100: Flange x 1, Bracket mounting bolt x 4, Spring washer x 4

Note) Order 2 foot brackets for a cylinder.

Theoretical Output

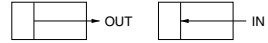

Bore size (mm)	Rod size (mm)	Operating direction	Piston area (mm ²)	Operating pressure (MPa)								
				0.2	0.3	0.4	0.5	0.6	0.7	0.8	0.9	1.0
20	10	OUT	314	63	94	126	157	188	220	251	283	314
		IN	236	47	71	94	118	142	165	189	212	236
25	12	OUT	491	98	147	196	246	295	344	393	442	491
		IN	378	76	113	151	189	227	265	302	340	378
32	12	OUT	804	161	241	322	402	482	563	643	724	804
		IN	691	138	207	276	346	415	484	553	622	691
40	16	OUT	1260	252	378	504	630	756	882	1010	1130	1260
		IN	1060	212	318	424	530	636	742	848	954	1060
50	20	OUT	1960	392	588	784	980	1180	1370	1570	1760	1960
		IN	1650	330	495	660	825	990	1160	1320	1490	1650
63	20	OUT	3120	624	936	1250	1560	1870	2180	2500	2810	3120
		IN	2800	560	840	1120	1400	1680	1960	2240	2520	2800
80	25	OUT	5030	1010	1510	2010	2520	3020	3520	4020	4530	5030
		IN	4540	908	1360	1820	2270	2720	3180	3630	4090	4540
100	30	OUT	7850	1570	2360	3140	3930	4710	5500	6280	7070	7850
		IN	7150	1430	2150	2860	3580	4290	5010	5720	6440	7150

(Note) Theoretical output (N) = Pressure (MPa) x Piston area (mm²)

Weight (In the case of 500 stroke)

Bore size (mm)		20	25	32	40	50	63	80	100
Basic weight	Basic type	1.20	1.62	2.04	3.20	4.90	6.08	8.93	13.60
	Axial foot type	1.44	1.88	2.44	3.72	5.95	7.32	11.04	16.67
	Flange type	1.29	1.79	2.23	3.47	5.68	6.97	10.67	15.92
Additional weight per each 50 mm of stroke		0.06	0.08	0.09	0.15	0.22	0.25	0.35	0.51

Calculation: (Example) **RHCL32-600**

- Basic mass (500 st) 2.44 (kg) (Foot type ø32)
 - Additional weight 0.09 (kg/50 st)
 - Cylinder stroke 600 (st)
- 2.44 + 0.09 x (600 - 500)/50 = 2.62 kg

Series Applicable to Operating Environments that Do Not Accept Copper

- Copper and Fluorine-free.....20-series
- * For details, refer to the SMC website.

RHC Series

Construction: $\varnothing 20$ to $\varnothing 40$

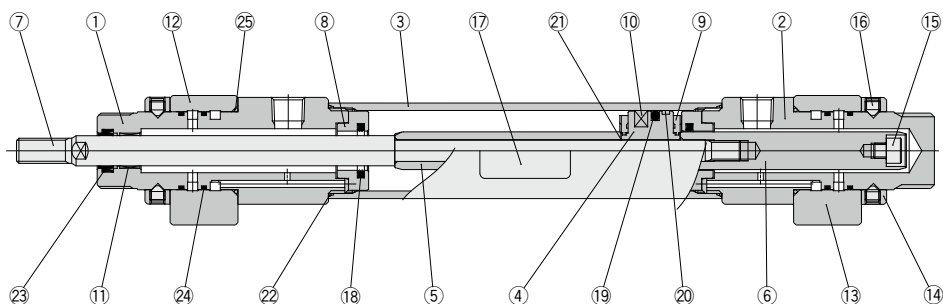

Component Parts

No.	Description	Material	Qty.	Note
1	Rod cover	Aluminum alloy	1	Anodized
2	Head cover	Aluminum alloy	1	Anodized
3	Cylinder tube	Aluminum alloy	1	Hard anodized
4	Piston	Aluminum alloy	1	
5	Cushion ring A	Carbon steel	1	Hard chrome plated
6	Cushion ring B	Carbon steel	1	Hard chrome plated
7	Piston rod	Carbon steel*	1	Hard chrome plated
8	Cushion spacer	Steel	2	$\varnothing 25, \varnothing 40$: Chromated
9	Bumper	Resin	2	
10	Magnet	—	1	
11	Bushing	Bearing alloy	1	
12	Relief valve assembly (Rod side)	—	1	
13	Relief valve assembly (Head side)	—	1	
14	Relief valve body holder	Aluminum alloy	2	Clear anodized
15	Hexagon socket head cap screw	Carbon steel	1	$\varnothing 20$: M5 x 0.8 x 6 $\varnothing 25, \varnothing 32$: M6 x 1 x 6 $\varnothing 40$: M8 x 1.25 x 8
16	Hexagon socket head set screw	Carbon steel	4	$\varnothing 20, \varnothing 25$: M5 x 0.8 x 6 $\varnothing 32, \varnothing 40$: M6 x 1 x 8
17	Plate	—	1	
18	Cushion seal	Special resin	2	
19	Piston seal	NBR	1	
20	Wear ring	Resin	1	
21	Piston gasket	NBR	1	
22	Cylinder tube gasket	NBR	2	
23	Rod seal	NBR	1	
24	O-ring	NBR	4	
25	O-ring	NBR	2	

* Stainless steel for $\varnothing 20$ and $\varnothing 25$

Replacement Parts/Seal Kit

Bore size (mm)	Kit no.	Contents
20	RHC20-PS	Set of nos. left (18, 19, 20, 22, 23, 24, 25)
25	RHC25-PS	
32	RHC32-PS	
40	RHC40-PS	

* Seal kit includes a grease pack (10 g).

Order with the following part number when only the grease pack is needed.

Grease pack part no.: GR-S-010 (10 g)

Caution

When disassembling cylinders with bore sizes of $\varnothing 20$ through $\varnothing 40$, grip the double flat part of either the rod cover or the head cover with a vise and loosen the other side with a wrench or an adjustable angle wrench, and then remove the cover. When re-tightening, tighten approximately 2 degrees more than the original position.

Construction: $\varnothing 50$ to $\varnothing 100$

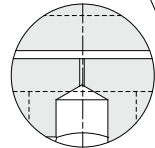
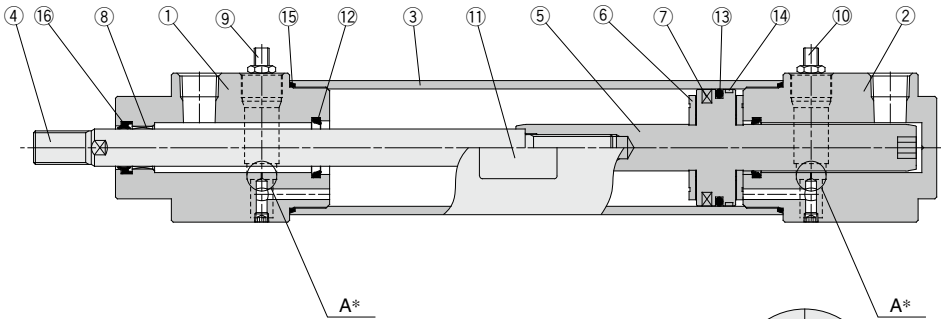

Enlarged view of "A"

Component Parts

No.	Description	Material	Qty.	Note
1	Rod cover	Aluminum alloy	1	Anodized
2	Head cover	Aluminum alloy	1	Anodized
3	Cylinder tube	Aluminum alloy	1	Hard anodized
4	Piston rod	Carbon steel	1	Hard chromate plated
5	Piston	Aluminum alloy	1	
6	Bumper	Resin	2	
7	Magnet	—	1	
8	Bushing	Bearing alloy	1	
9	Relief valve assembly (Rod side)	—	1	
10	Relief valve assembly (Head side)	—	1	
11	Plate	—	1	
12	Cushion seal	Urethan	2	
13	Piston seal	NBR	1	
14	Wear ring	Resin	1	
15	Cylinder tube gasket	NBR	2	
16	Rod seal	NBR	1	

⚠ Caution

Cylinders with $\varnothing 50$ or larger bore sizes are tightened with a large tightening torque and cannot be disassembled.

RHC Series

Dimensions: Basic Type

ø20 to ø40

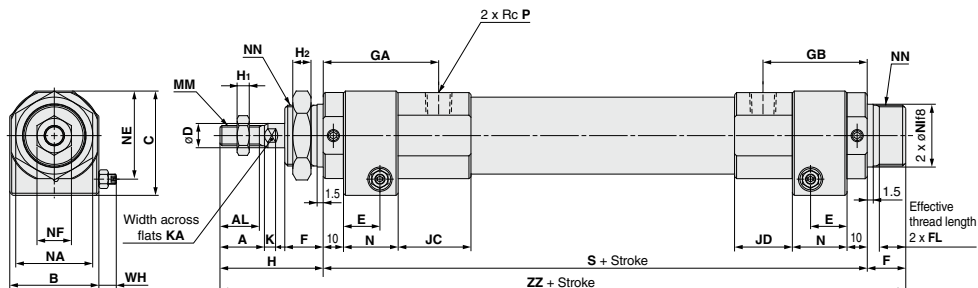

Bore size (mm)	A	AL	B	C	D	E	F	FL	GA	GB	H	H ₁	H ₂
20	18	15.5	32	40.5	10	14.5	16	11.5	53.5	47.5	44	5	8
25	22	19.5	36	45.5	12	18	16	11.5	56.5	49.5	48	6	8
32	22	19.5	44	51.5	12	18	19	14.5	55	51.5	51	6	9
40	24	21	53	61.5	16	20.5	21	16.5	56	51.5	54.5	8	11

Bore size (mm)	JC	JD	K	KA	MM	N	NE	NA	NF	NI	NN	P	S	WH	ZZ
20	43	30.5	5	8	M8 x 1.25	22	33.5	26	13	23 ^{+0.022} _{-0.053}	M22 x 1.5	1/4	192	5.8 to 8.8	252
25	39	25.5	5.5	10	M10 x 1.25	27	37	32	17	25 ^{+0.020} _{-0.063}	M24 x 1.5	1/4	193		257
32	36	28.5	5.5	10	M10 x 1.25	27	43.5	38	17	31 ^{+0.025} _{-0.064}	M30 x 1.5	3/8	195		265
40	32	23	7.5	14	M14 x 1.5	30	52.5	41	22	34 ^{+0.025} _{-0.061}	M33 x 2.0	3/8	201.5		277

ø50 to ø100

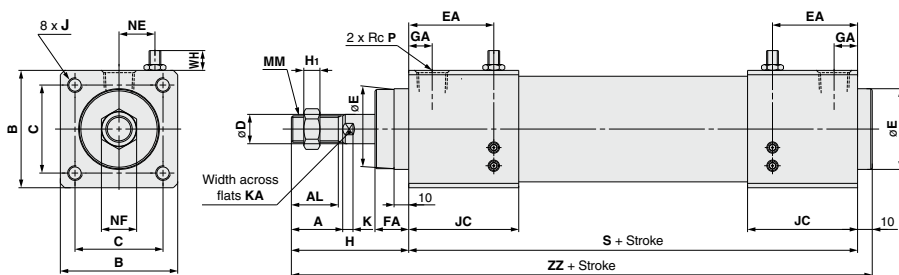

Bore size (mm)	A	AL	B	C	D	E	EA	FA	GA	H
50	35	32	70	53	20	50 ^{+0.030} _{-0.074}	62	23	16	80
63	35	32	80	60	20	55 ^{+0.030} _{-0.074}	58	23	16	80
80	40	37	95	75	25	65 ^{+0.030} _{-0.074}	61	23	20	90
100	40	37	116	90	30	80 ^{+0.030} _{-0.074}	63	25	20	95

Bore size (mm)	H ₁	J	JC	K	KA	MM	NE	NF	P	S	WH	ZZ
50	11	M10 x 1.5 thread depth 20	75	7	18	M18 x 1.5	25	27	1/2	215	6.8 to 11.3	305
63	11	M10 x 1.5 thread depth 20	75	7	18	M18 x 1.5	24.5	27	1/2	215		305
80	13	M12 x 1.75 thread depth 25	78	10	22	M22 x 1.5	30.5	32	3/4	228		328
100	16	M12 x 1.75 thread depth 25	80	10	26	M26 x 1.5	34	41	3/4	236		341

RHC Series

Dimensions: Rod Side Flange Type

ø20 to ø40

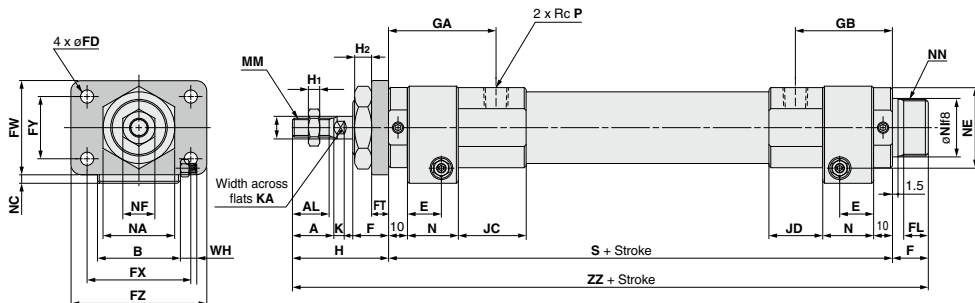

Bore size (mm)	A	AL	B	D	E	F	FL	FD	FT	FX	FY	FW	FZ	GA	GB	H ₁	H ₂
20	18	15.5	32	10	14.5	16	11.5	7	6	51	21	38	68	53.5	47.5	5	8
25	22	19.5	36	12	18	16	11.5	7	9	53	27	44	70	56.5	49.5	6	8
32	22	19.5	44	12	18	19	14.5	7	9	55	33	50	72	55	51.5	6	9
40	24	21	53	16	20.5	21	16.5	9	9	66	36	60	84	56	51.5	8	11

Bore size (mm)	H	JC	JD	K	KA	MM	N	NA	NC	NE	NF	NI	NN	P	S	WH	ZZ
20	44	43	30.5	5	8	M8 x 1.25	22	26	5.5	33.5	13	23 ^{+0.030} _{-0.063}	M22 x 1.5	1/4	192		252
25	48	39	25.5	5.5	10	M10 x 1.25	27	32	5.5	37	17	25 ^{+0.030} _{-0.063}	M24 x 1.5	1/4	193	5.8 to 8.8	257
32	51	36	28.5	5.5	10	M10 x 1.25	27	38	4.5	43.5	17	31 ^{+0.030} _{-0.064}	M30 x 1.5	3/8	195		265
40	54.5	32	23	7.5	14	M14 x 1.5	30	41	4.5	52.5	22	34 ^{+0.030} _{-0.064}	M33 x 2.0	3/8	201.5	6.8 to 11.3	277

ø50 to ø100

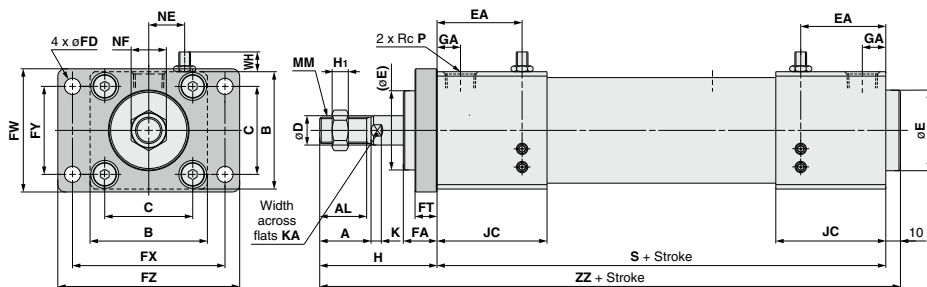

Bore size (mm)	A	AL	B	C	D	E	EA	FA	FD	FT	FW	FX
50	35	32	70	53	20	50 ^{+0.062}	62	23	11	15	78	96
63	35	32	80	60	20	55 ^{+0.074}	58	23	11	15	84	104
80	40	37	95	75	25	65 ^{+0.074}	61	23	13	18	106	130
100	40	37	116	90	30	80 ^{+0.074}	63	25	13	20	120	145

Bore size (mm)	FY	FZ	GA	H	H ₁	JC	K	KA	MM	NE	NF	P	S	WH	ZZ
50	53	116	16	80	11	75	7	18	M18 x 1.5	25	27	1/2	215	6.8 to 11.3	305
63	60	124	16	80	11	75	7	18	M18 x 1.5	24.5	27	1/2	215		305
80	75	155	20	90	13	78	10	22	M22 x 1.5	30.5	32	3/4	228	8.5 to 13.5	328
100	90	172	20	95	16	80	10	26	M26 x 1.5	34	41	3/4	236		341

Dimensions: Head Side Flange Type

ø20 to ø40

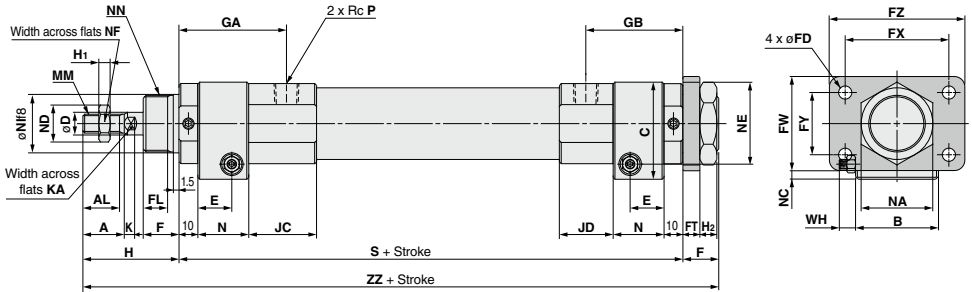

																	(mm)	
Bore size (mm)	A	AL	B	C	D	E	F	FL	FD	FT	FX	FY	FW	FZ	GA	GB	H ₁	H ₂
20	18	15.5	32	40.5	10	14.5	16	11.5	7	6	51	21	38	68	53.5	47.5	5	8
25	22	19.5	36	45.5	12	18	16	11.5	7	9	53	27	44	70	56.5	49.5	6	8
32	22	19.5	44	51.5	12	18	19	14.5	7	9	55	33	50	72	55	51.5	6	9
40	24	21	53	61.5	16	20.5	21	16.5	9	9	66	36	60	84	56	51.5	8	11

Bore size (mm)	H	JC	JD	K	KA	MM	N	NA	NB	NC	NE	NF	NI	NN	P	S	WH	ZZ
20	44	43	30.5	5	8	M8 x 1.25	22	26	30	5.5	33.5	13	23 ^{+0.025}	M22 x 1.5	1/4	192	5.8 to 8.8	252
25	48	39	25.5	5.5	10	M10 x 1.25	27	32	36.9	5.5	37	17	25 ^{+0.025}	M24 x 1.5	1/4	193	5.8 to 8.8	257
32	51	36	28.5	5.5	10	M10 x 1.25	27	38	43.9	4.5	43.5	17	31 ^{+0.025}	M30 x 1.5	3/8	195	6.8 to 11.3	265
40	54.5	32	23	7.5	14	M14 x 1.5	30	41	47.3	4.5	52.5	22	34 ^{+0.025}	M33 x 2.0	3/8	201.5	6.8 to 11.3	277

ø50 to ø100

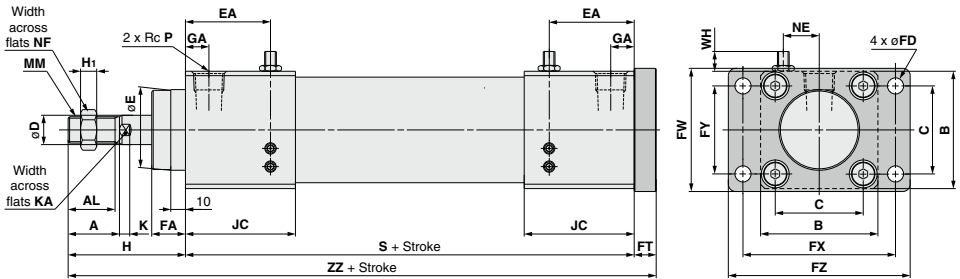

																	(mm)	
Bore size (mm)	A	AL	B	C	D	E	EA	FA	FD	FT	FW	FX	FY					
50	35	32	70	53	20	50 ^{+0.062}	62	23	11	15	78	96	53					
63	35	32	80	60	20	55 ^{+0.074}	58	23	11	15	84	104	60					
80	40	37	95	75	25	65 ^{+0.074}	61	23	13	18	106	130	75					
100	40	37	116	90	30	80 ^{+0.074}	63	25	13	20	120	145	90					

Bore size (mm)	FZ	GA	H	H ₁	JC	K	KA	MM	NE	NF	P	S	WH	ZZ
50	116	16	80	11	75	7	18	M18 x 1.5	25	27	1/2	215	6.8 to 11.3	310
63	124	16	80	11	75	7	18	M18 x 1.5	24.5	27	1/2	215	6.8 to 11.3	310
80	155	20	90	13	78	10	22	M22 x 1.5	30.5	32	3/4	228	8.5 to 13.5	336
100	172	20	95	16	80	10	26	M26 x 1.5	34	41	3/4	236	8.5 to 13.5	351

RHC Series Accessory

Mounting Nut

(mm)

Material: Carbon steel

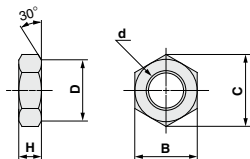

Part no.	Applicable bore size (mm)	B	C	D	d	H
SOR-20	20	26	30	26	M22 x 1.5	8
SOR-25	25	32	36.9	32	M24 x 1.5	8
SOR-32	32	38	43.9	38	M30 x 1.5	9
SOR-40	40	41	47.3	41	M33 x 2.0	11

Rod End Nut

(mm)

Material: Carbon steel

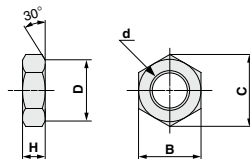

Part no.	Applicable bore size (mm)	B	C	D	d	H
NT-02	20	13	15	12.5	M8 x 1.25	5
NT-03	25/32	17	19.6	16.5	M10 x 1.25	6
NT-04	40	22	25.4	21.0	M14 x 1.5	8
NT-05	50/63	27	31	26	M18 x 1.5	11
NT-08	80	32	37	31	M22 x 1.5	13
NT-10	100	41	47.3	39	M26 x 1.5	16

Auto Switch Mounting 1

Minimum Stroke for Auto Switch Mounting

n: No. of auto switches (mm)

Auto switch model	No. of auto switches mounted				
	1	2		n	
		Different surfaces	Same surface	Different surfaces	Same surface
D-A9□ D-M9□ D-M9□W	10	15 Note 1)	45 Note 1)	$15 + 45 \frac{(n-2)}{2}$ (n = 2, 4, 6...) ^{Note 3)}	$45 + 45 (n-2)$ (n = 2, 3, 4, 5...)
D-M9□	5	15 Note 1)	40 Note 1)	$20 + 35 \frac{(n-2)}{2}$ (n = 2, 4, 6...) ^{Note 3)}	$55 + 35 (n-2)$ (n = 2, 3, 4, 5...)
D-M9□W	10	15 Note 1)	40 Note 1)	$20 + 35 \frac{(n-2)}{2}$ (n = 2, 4, 6...) ^{Note 3)}	$55 + 35 (n-2)$ (n = 2, 3, 4, 5...)
D-M9□A	10	25	40 Note 1)	$25 + 35 \frac{(n-2)}{2}$ (n = 2, 4, 6...) ^{Note 3)}	$60 + 35 (n-2)$ (n = 2, 3, 4, 5...)
D-A9□	5	15	30 Note 1)	$15 + 35 \frac{(n-2)}{2}$ (n = 2, 4, 6...) ^{Note 3)}	$50 + 35 (n-2)$ (n = 2, 3, 4, 5...)
D-M9□V	5	20	35	$20 + 35 \frac{(n-2)}{2}$ (n = 2, 4, 6...) ^{Note 3)}	$35 + 35 (n-2)$ (n = 2, 3, 4, 5...)
D-A9□V	5	15	25	$15 + 35 \frac{(n-2)}{2}$ (n = 2, 4, 6...) ^{Note 3)}	$25 + 35 (n-2)$ (n = 2, 3, 4, 5...)
D-M9□WV D-M9□AV	10	20	35	$20 + 35 \frac{(n-2)}{2}$ (n = 2, 4, 6...) ^{Note 3)}	$35 + 35 (n-2)$ (n = 2, 3, 4, 5...)
D-C7□ D-C80	10	15	50	$15 + 45 \frac{(n-2)}{2}$ (n = 2, 4, 6...) ^{Note 3)}	$50 + 45 (n-2)$ (n = 2, 3, 4, 5...)
D-H7□ D-H7□W D-H7BA D-H7NF	10	15	60	$15 + 45 \frac{(n-2)}{2}$ (n = 2, 4, 6...) ^{Note 3)}	$60 + 45 (n-2)$ (n = 2, 3, 4, 5...)
D-C73C D-C80C D-H7C	10	15	65	$15 + 50 \frac{(n-2)}{2}$ (n = 2, 4, 6...) ^{Note 3)}	$65 + 50 (n-2)$ (n = 2, 3, 4, 5...)
D-B5□/B64 D-G5□/K59 D-G5□W/K59W D-G5BA D-G5NT	10	15	75	$15 + 50 \frac{(n-2)}{2}$ (n = 2, 4, 6...) ^{Note 3)}	$75 + 55 (n-2)$ (n = 2, 3, 4, 5...)
D-B59W	15	20	75	$20 + 50 \frac{(n-2)}{2}$ (n = 2, 4, 6...) ^{Note 3)}	$75 + 55 (n-2)$ (n = 2, 3, 4, 5...)
D-A3□ D-A44 D-G39 D-K39	10	35	100	$35 + 30 (n-2)$ (n = 2, 3, 4, 5...)	$100 + 100 (n-2)$ (n = 2, 3, 4, 5...)

Note 3) When "n" is an odd number, an even number that is one larger than this odd number is used for the calculation.

Note 1) Auto switch mounting

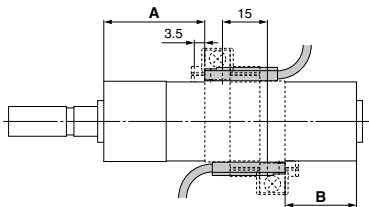
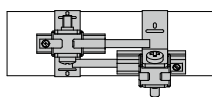
Auto switch model	2 auto switches	
	Different surfaces ^{Note 1)}	Same surface ^{Note 1)}
	 <p>Correct auto switch mounting position is 3.5 mm from the back face of the switch holder.</p>	 <p>The auto switch is mounted by slightly displacing it in a direction (cylinder tube circumferential exterior) so that the auto switch and lead wire do not interfere with each other.</p>
D-M9□ D-M9□W	Less than 20 stroke ^{Note 2)}	Less than 55 stroke ^{Note 2)}
D-M9□A	Less than 20 stroke ^{Note 2)}	Less than 60 stroke ^{Note 2)}
D-A9□	—	Less than 50 stroke ^{Note 2)}

Note 2) Minimum stroke for auto switch mounting in types other than those mentioned in Note 1.

Auto Switch Mounting 2

Auto Switch Proper Mounting Position (Detection at Stroke End) and Its Mounting Height

Reed auto switch

D-A9□

ø20 to ø40

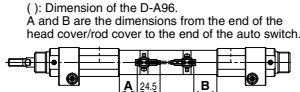

() : Dimension of the D-A96.
A and B are the dimensions from the end of the head cover/rod cover to the end of the auto switch.

ø50 to ø63

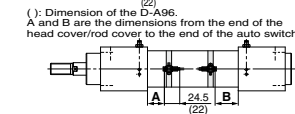

() : Dimension of the D-A96.
A and B are the dimensions from the end of the head cover/rod cover to the end of the auto switch.

D-A9□V

ø20 to ø40

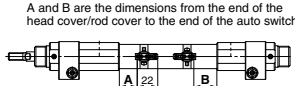

A and B are the dimensions from the end of the head cover/rod cover to the end of the auto switch.

ø50 to ø63

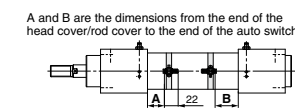

A and B are the dimensions from the end of the head cover/rod cover to the end of the auto switch.

D-C7□, C80

ø20 to ø40

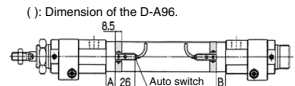

() : Dimension of the D-A96.

ø50 to ø63

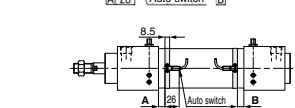

D-B5□, B64, B59W

ø20 to ø40

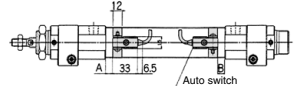

ø50 to ø63

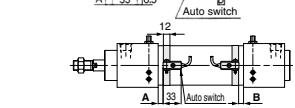

D-C73C, C80C

ø20 to ø40

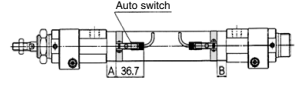

ø50 to ø63

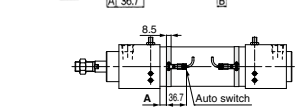

D-A3□, G39, K39

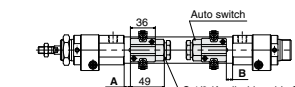

G 1/2 (Applicable cable O.D. ø6.8 to ø11.5)

Solid state auto switch

D-M9□, M9□W, M9□A

ø20 to ø40

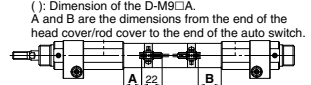

() : Dimension of the D-M9□A.
A and B are the dimensions from the end of the head cover/rod cover to the end of the auto switch.

ø50 to ø63

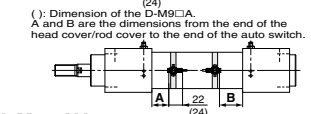

() : Dimension of the D-M9□A.
A and B are the dimensions from the end of the head cover/rod cover to the end of the auto switch.

D-M9□V, M9□WV, M9□AV

ø20 to ø40

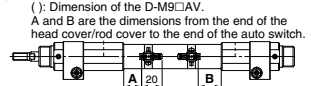

() : Dimension of the D-M9□AV.
A and B are the dimensions from the end of the head cover/rod cover to the end of the auto switch.

ø50 to ø63

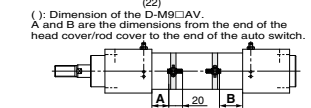

() : Dimension of the D-M9□AV.
A and B are the dimensions from the end of the head cover/rod cover to the end of the auto switch.

D-H7□, H7□W, H7NF, H7BA

ø20 to ø40

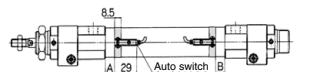

ø50 to ø63

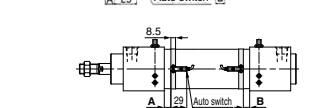

D-G5□, K59, G5□W, K59W, G5NT, G5BA

ø20 to ø40

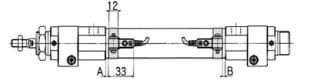

ø50 to ø63

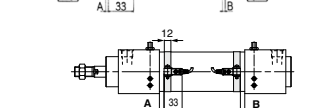

D-H7C

ø20 to ø40

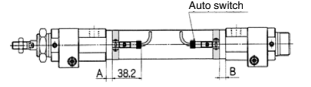

ø50 to ø63

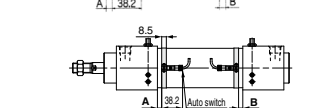

D-A44

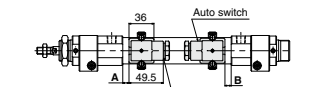

G 1/2 (Applicable cable O.D. ø6.8 to ø11.5)

Auto Switch Proper Mounting Position (Detection at Stroke End) and Its Mounting Height

Auto Switch Proper Mounting Position

(mm)

Auto switch model Bore size (mm)	D-A9□ D-A9□V		D-M9□ D-M9□W D-M9□A D-M9□V D-M9□WV D-M9□AV		D-C7□ D-C80 D-C73C D-C80C		D-B5□ D-B64		D-H7□ D-H7C D-H7NF D-H7□W D-H7BA		D-G5□ D-G5□W D-G5NT D-G5BA D-K59 D-K59W		D-B59W		D-A33□ D-A44 D-G39 D-K39	
	A	B	A	B	A	B	A	B	A	B	A	B	A	B	A	B
20	14.5	20	18.5	24	15	20.5	9	14.5	14	19.5	10.5	16	12	17.5	8.5	14
25	14.5	20	18.5	24	15	20.5	9	14.5	14	19.5	10.5	16	12	17.5	8.5	14
32	14.5	22	18.5	26	15	22.5	9	16.5	14	21.5	10.5	18	12	19.5	8.5	16
40	19.5	27	23.5	31	20	27.5	14	21.5	19	26.5	15.5	23	17	24.5	13.5	21
50	17.5	27.5	21.5	31.5	18	28	12	22	17	27	13.5	23.5	15	25	11.5	21.5
63	17.5	27.5	21.5	31.5	18	28	12	22	17	27	13.5	23.5	15	25	11.5	21.5
80	—	—	—	—	—	—	13.5	27.5	—	—	15	29	16.5	30.5	13	27
100	—	—	—	—	—	—	15.5	29.5	—	—	17	31	18.5	32.5	15	29

Note) Adjust the auto switch after confirming the operating conditions in the actual setting.

Auto Switch Mounting Height

(mm)

Auto switch model Bore size (mm)	D-M9□V D-M9□WV D-M9□AV D-A9□V	D-M9□ D-M9□W D-M9□A D-A9□	D-H7□ D-H7□W D-H7NF D-H7BA D-C7/C8	D-B5□/B64 D-B59W D-G5□/K59 D-G5□W D-K59W D-G5NT D-G5BA D-H7C	D-C73C D-C80C	D-A3□ D-G39 D-K39	D-A44
	Hs	Hs	Hs	Hs	Hs	Hs	Hs
20	25.5	24.5	27.5	27	62	72	
25	28	27	30	29.5	64.5	74.5	
32	31.5	30.5	33.5	33	68	78	
40	36	35	38	37.5	72.5	82.5	
50	41.5	40.5	43.5	43	78	88	
63	48.5	47.5	50.5	50.5	85	95	
80	—	—	59	—	93.5	103.5	
100	—	—	69.5	—	104	114	

Auto Switch Mounting 3

Operating Range

Auto switch model	Bore size (mm)							
	20	25	32	40	50	63	80	100
D-A9□(V)	7	6	8	8	8	9	—	—
D-M9□(V)								
D-M9□W(V)	3.5	3.5	4	4	5	5.5	—	—
D-M9□A(V)								
D-C7□/C80	8	10	9	10	10	11	—	—
D-C73C/C80C								
D-B5□/B64	8	10	9	10	10	11	11	11
D-B59W	13	13	14	14	14	17	16	18
D-H7□/H7NF/H7□W/H7BA	4	4	4.5	5	6	6.5	6.5	7
D-H7C	7	8.5	9	10	9.5	10.5	10.5	11
D-A3□/A44	9	10	9	10	10	11	11	11
D-G39/K39	8	9	9	9	9	10	10	11
D-G5□/K59/G5□W								
D-K59W/G5BA/G5NT	4	4	4.5	5	6	6.5	6.5	7

* Since this is a guideline including hysteresis, not meant to be guaranteed. (Assuming approximately ±30% dispersion.)
There may be the case it will vary substantially depending on an ambient environment.

Mounting Bracket Part No.

Auto switch model	Bore size (mm)							
	ø20	ø25	ø32	ø40	ø50	ø63	ø80	ø100
D-M9□(V)	Note 1) BMA3-020	Note 1) BMA3-025	Note 1) BMA3-032	Note 1) BMA3-040	Note 1) BMA3-050	Note 1) BMA3-063	—	—
D-M9□W(V)	(A set of a, b, c, d)	(A set of a, b, c, d)	(A set of a, b, c, d)	(A set of a, b, c, d)	(A set of a, b, c, d)	(A set of a, b, c, d)	—	—
D-A9□(V)								
D-M9□A(V) Note 2)	BMA3-020S (A set of b, c, d, e)	BMA3-025S (A set of b, c, d, e)	BMA3-032S (A set of b, c, d, e)	BMA3-040S (A set of b, c, d, e)	BMA3-050S (A set of b, c, d, e)	BMA3-063S (A set of b, c, d, e)	—	—
D-H7□ D-H7□W D-H7NF D-C7□/C80 D-C73C/C80C	BMA2-020A (A set of c and d)	BMA2-025A (A set of c and d)	BMA2-032A (A set of c and d)	BMA2-040A (A set of c and d)	BMA2-050A (A set of c and d)	BMA2-063A (A set of c and d)	—	—
D-H7BA	BMA2-020AS (A set of c and f)	BMA2-025AS (A set of c and f)	BMA2-032AS (A set of c and f)	BMA2-040AS (A set of c and f)	BMA2-050AS (A set of c and f)	BMA2-063AS (A set of c and f)	—	—
D-B5□/B64 D-B59W D-G5□/K59 D-G5□W/K59F D-G5BA/G59F D-G5NT	BA-01 (A set of c and d)	BA-02 (A set of c and d)	BA-32 (A set of c and d)	BA-04 (A set of c and d)	BA-05 (A set of c and d)	BA-06 (A set of c and d)	BA-08	BA-10
D-A3□/A44 D-G39/K39	BD1-01M (c only)	BD1-02M (c only)	BD1-02 (c only)	BD1-04M (c only)	BD1-05M (c only)	BD1-06M (c only)	BD1-08M (c only)	BD1-10M (c only)

Note 1) As the switch bracket is made of polyamide, its performance may be affected by chemicals such as alcohol, chloroform, methylamines, hydrochloric acid, and sulfuric acid, so it cannot be used in environments where these chemicals come into contact with the product.

Note 2) When mounting a D-M9□A(V) type auto switch, if the switch bracket is mounted on the indicator light, it may damage the auto switch. Therefore, be sure to avoid mounting the switch bracket on the indicator light.

[Mounting screw set made of stainless steel]

The following set of mounting screws made of stainless steel is available. Use it in accordance with the operating environment. (Please order the auto switch mounting bracket separately, since it is not included.)

BBA3: For D-B5/B6/G5/K5
BBA4: D-C7/C8/H7

The above stainless steel screws are used when a cylinder is shipped with the D-H7BA or G5BA auto switches.

When only an auto switch is shipped independently, the BBA3 or BBA4 is attached.

Refer to pages 1439 and 1440 for details of the BBA1 and BBA2.

Other than the applicable auto switches listed in "How to Order", the following auto switches can be mounted. For detailed specifications, refer to pages 1341 to 1435.

Type	Model	Electrical entry (Fatching direction)	Features	Applicable bore size (mm)
Reed	D-C73, C76	Grommet (In-line)	—	ø20 to ø63
	D-C80		Without indicator/light	ø20 to ø100
	D-B53		—	ø20 to ø63
Solid state	D-H7A1, H7A2, H7B	Grommet (In-line)	—	ø20 to ø63
	D-H7NW, H7PW, H7BW		Diagnostic indication (Indicator indication)	ø20 to ø100
	D-G5NT		With timer	ø20 to ø100

* For solid state auto switches, auto switches with a pre-wired connector are also available. Refer to pages 1410 and 1411 for details.

* Normally closed (NC = b contact) solid state auto switches (D-M9□E(V)) are also available. Refer to page 1360 for details.

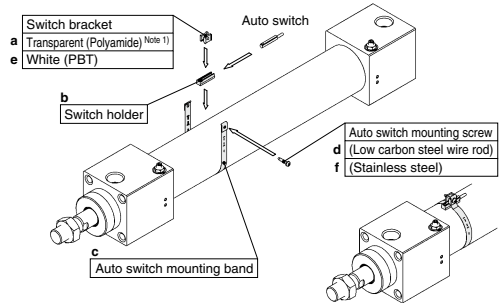

(With switch installed)

* Band (c) is mounted so that the projected part is on the internal side (contact side with the tube).



RHC Series Specific Product Precautions

Be sure to read this before handling the products.

Refer to page 9 for safety instructions and pages 10 to 19 for actuator and auto switch precautions.

Mounting

Caution

Use an external guide, etc. for horizontal actuation of a load.

How to Rotate the Relief Valve Body (ø20, ø25, ø32, ø40)

Caution

The relief adjusting screw can be placed in any direction by rotating the relief valve body by following the steps given below.

Procedure

1. Verify that there is no residual pressure in the cylinder. Then, loosen the mounting bracket (such as foot, flange, etc.).
2. Loosen the set screw that is provided in the relief valve body retainer and rotate the relief valve body.
3. While keeping the relief valve body retainer pressed against the relief valve body, secure it with the set screw. After having secured the relief valve body retainer, make sure that the relief valve body cannot be rotated. In the event that it does rotate, loosen the set screw again and repeat the operation described in step 3.

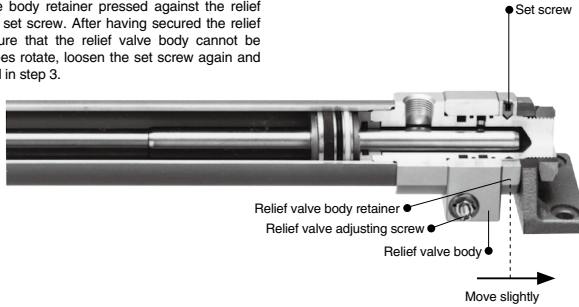

Handling

Caution

1. Confirm that the relief valve body does not rotate when the cylinder is mounted. If there is play in the axial direction of the relief valve body, the cushion may become ineffective. When attaching brackets (foot, flange), do so after loosening the relief valve body set screw. Retighten the relief valve body set screw after the brackets have been attached. (ø20, 25, 32, 40)
2. The cylinder stroke end cushion adjusting screw is adjusted six turns (10 turns for ø63, ø80 and ø100) starting from the position where it is rotated fully clockwise to counterclockwise (fully closed). It should never be rotated more than six turns (more than 10 turns for ø63, ø80 and ø100) from the position where it is rotated fully counterclockwise (fully open). This may damage the spring inside the relief valve.
3. The cylinder ports are designed so that a maximum speed 3000 mm/s can be obtained. However, it may not be possible to attain the desired speed in the case of short cylinder strokes. It may also be impossible to attain the desired speed due to restriction by component equipment (valves, speed control valves, piping, fitting, etc.). Make every effort to ensure sufficient effective area in the component equipment.
4. Avoid applications in which lateral loads are applied to the cylinder piston rod. Especially in the case of long strokes, implement measures such as providing a guide for the load.

