

Sine Cylinder

REC Series

ø20, ø25, ø32, ø40

Allows high speed transfer of work with dramatically reduced shock/impact.

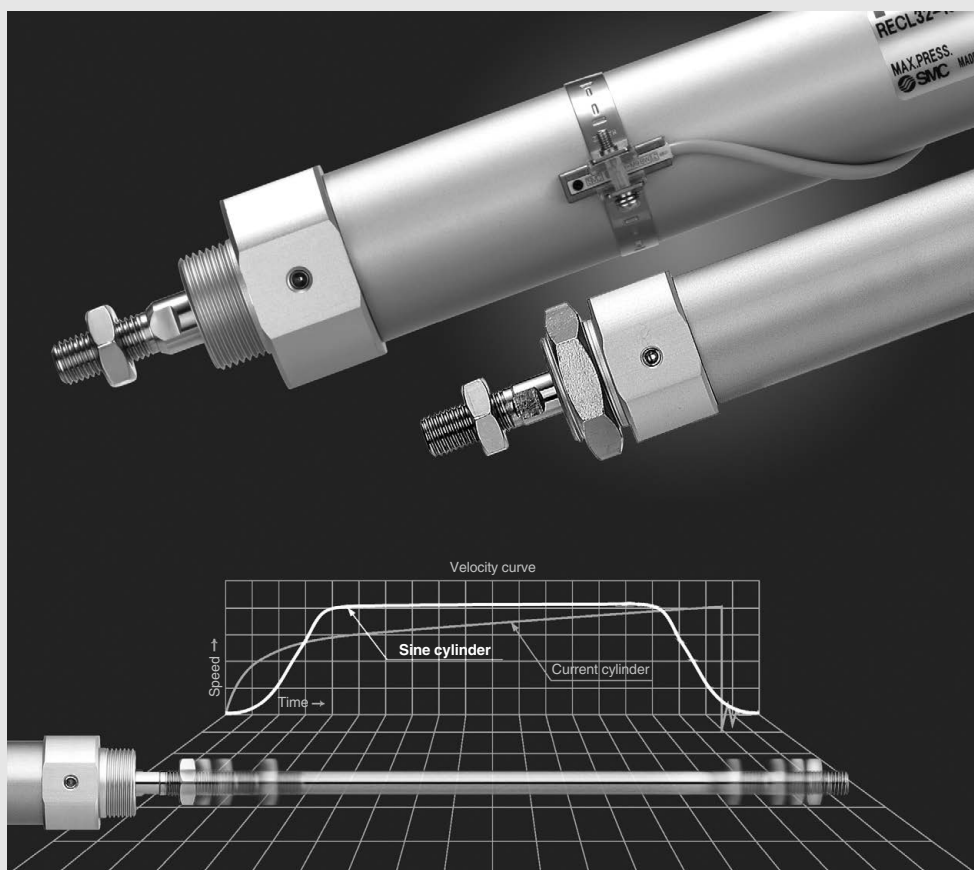

Sine Cylinder *REC Series*

∅20,∅25,∅32,∅40

Allows rapid transfer of work

Motion comparison with the one with shock absorber

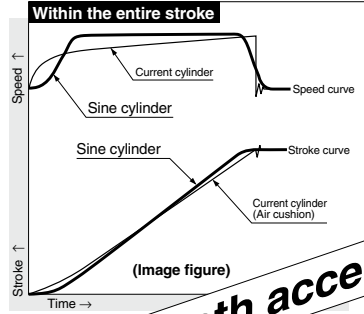
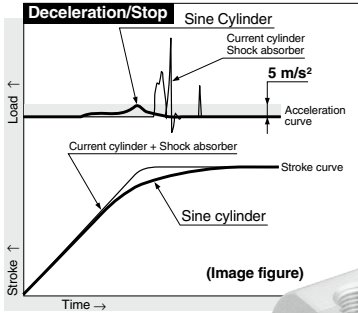

Smooth acceleration

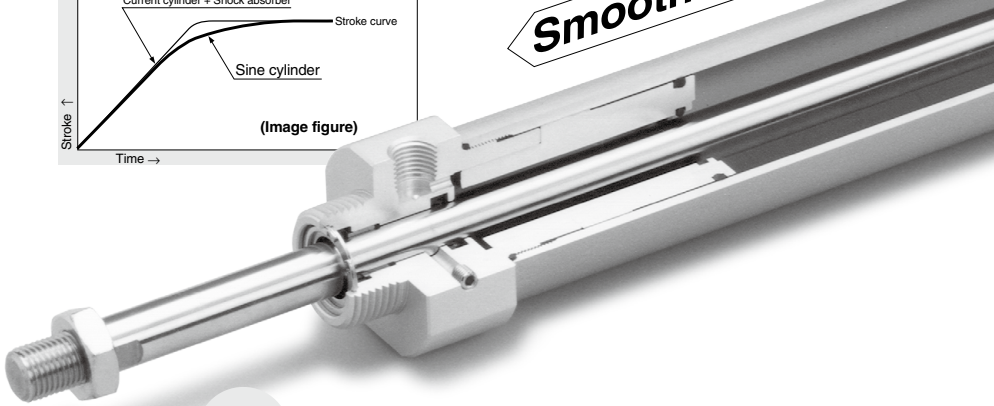

Space-saving has been realized by simple circuit

Comparison to Shockless Transfer Systems

Current System				Sine Cylinder
Control method	Speed control by a flow control valve which can variable throttle flow according to indicated current.	Shock absorber	Multistage speed control by combining speed controllers and a directional control valve.	Cushioning keep up with depth of orifice as sine function which change depend on stroke.
System construction	<p>Symbol</p> <p>Current system 1</p>			
Acceleration	Smooth operation	Same start up as standard cylinder due to lack of slow controlled start function.	Smooth speed control cannot be achieved by digital control changes are associated with it.	
Deceleration	Smooth operation	Initial impact is large. (Initial force against shock absorber)	Smooth speed control cannot be achieved by digital control, and sudden speed changes are associated with it.	Smooth operation without sudden speed changes
Construction	Complex	Simple	Complex	Smooth operation without sudden speed changes
				Simple

Compatible with Clean Room ISO Class 4 (ISO14644-1). (Refer to page 133.)

This model conforming to the clean room specification removes dust generated inside with an exhaust from the relief port or vacuum sweeping.

with dramatically reduced shock/impact.

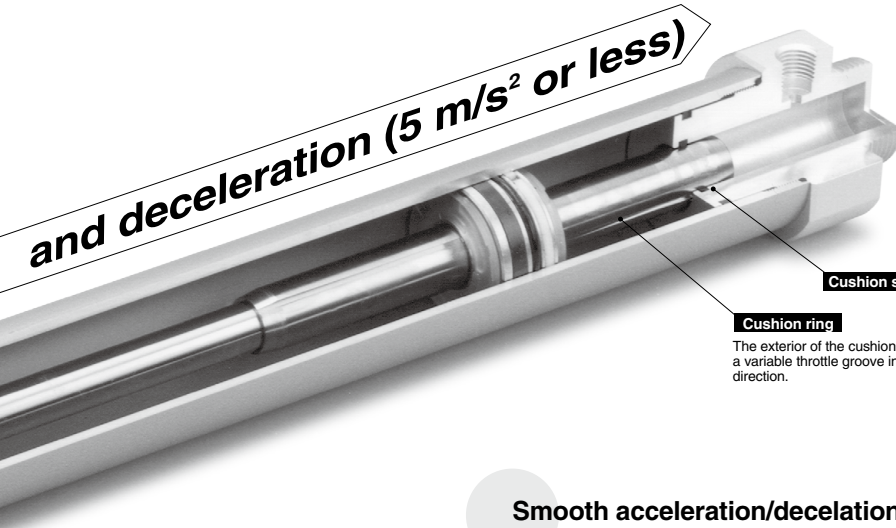

and deceleration (5 m/s^2 or less)

Cushion seal

Cushion ring

The exterior of the cushion ring is provided with a variable throttle groove in its longitudinal direction.

Smooth acceleration/deceleration without having influence from load, speed or pressure fluctuation

Reducing actuation cycle time

Max. 500 mm/s of high speed transfer is possible. Cycle time can be drastically reduced compared with current low speed cylinder (10 to 30 mm/s).

Reference Example) Motion on RECL32-300

Pressure Fluctuation

Pressure (MPa)	0.3	0.5
Load (kg)	10	
Speed (mm/s)	300	

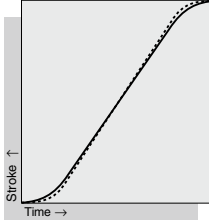

— P=0.5 MPa, M=10 kg
 P=0.3 MPa, M=10 kg

Load Fluctuation

Pressure (MPa)	0.5	
Load (kg)	10	30
Speed (mm/s)	300	

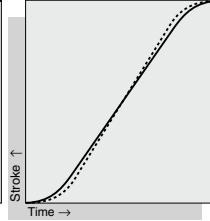

— M=10 kg
 M=30 kg

Pressure (MPa)	0.5	
Load (kg)	10	
Speed (mm/s)	100	300

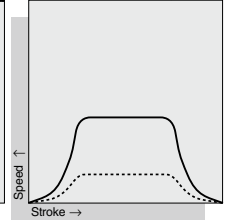

— V=300 mm/s
 V=100 mm/s

⚠ Caution

Recommended Speed Controllers

Model	Model		
	Elbow type	Straight type	In-line type
REC20	AS2201F-01-06-X214	AS2301F-01-06-X214	AS2001F-06-X214
REC25	AS2201F-01-06-X214	AS2301F-01-06-X214	AS2001F-06-X214
REC32	AS2201F-01-06-X214	AS2301F-01-06-X214	AS3001F-08-X214
REC40	AS3201F-02-08-X214	AS3301F-02-08-X214	AS3001F-08-X214

⚠ Caution

Use the recommended speed controllers. (Refer to page 143.)

REC Series Model Selection

Selection Step

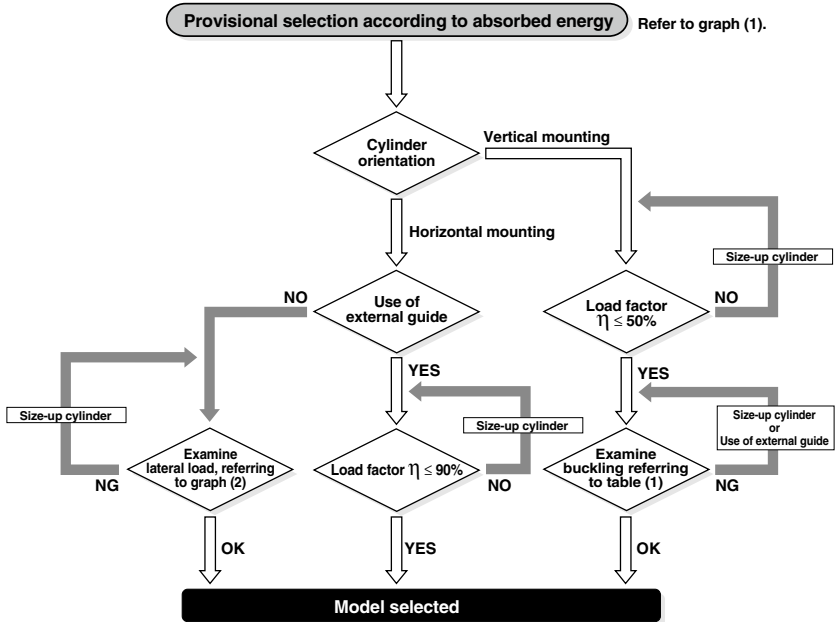

Selection Example 1

Actuating orientation: Horizontal transfer of work (without external guide)
 Load mass: $M = 0.2$ kg (2N)
 Cylinder stroke: 300 mm
 Maximum speed: $v = 200$ mm/s
 Supply pressure: $P = 0.5$ MPa

REC20 provisionally selected from graph (1) ($M = 0.2$ kg, $v = 200$ mm/s)

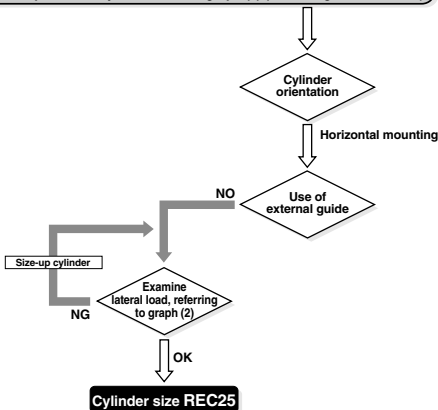

Selection Example 2

Actuating orientation: Vertical transfer of work (Rod side flange)
 Load mass: $M = 10$ kg
 Cylinder stroke: 400 mm
 Maximum speed: $v = 300$ mm/s
 Supply pressure: $P = 0.5$ MPa

REC25 provisionally selected from graph (1) ($M = 10$ kg, $v = 300$ mm/s)

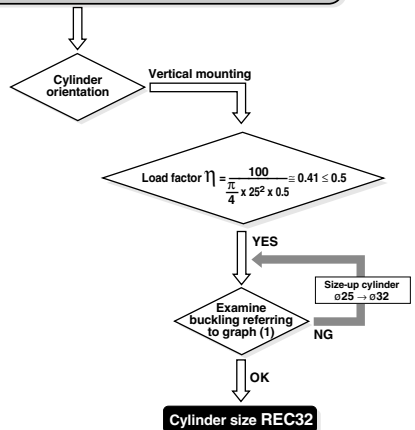

Graph (1) Absorbed Energy Curve

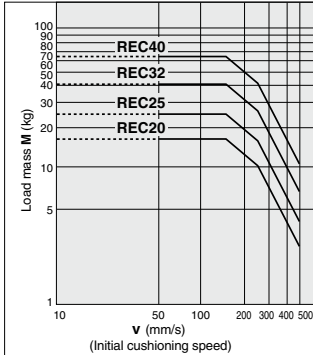

Graph (2) Applicable Max. Stroke Against Lateral Load*

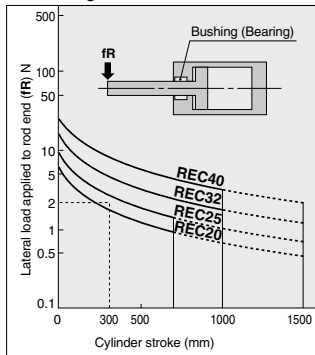

* The above curve in the graph refers to P = 0.5 MPa of supply pressure. If supply pressure is other than P = 0.5 MPa, please figure out a max. stroke, using proportional calculation.

Example) If P = 0.6 MPa, a max. stroke = $\frac{0.6}{0.5}$ = the respective stroke in the graph x 0.5

Figure (1)

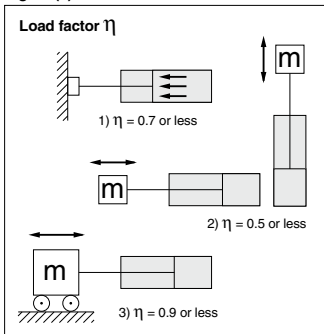

Table (1) Relation between Cylinder Size and Max. Stroke

(cm)

Mounting type			Symbol	Operating pressure (MPa)	Applicable max. stroke according to buckling strength						
Mounting bracket symbol and figure					REC						
					ø20	ø25	ø32	ø40			
Foot type: L	Rod side flange type: F	Head side flange type: G		0.3	39	50	56	61			
				0.5	30	38	43	47			
				0.7	24	31	36	39			
Clevish type: C, D	Rod side trunnion type: U	Head side trunnion type: T		0.3	11	17	19	21			
				0.5	7	11	13	13			
				0.7	4	7	9	9			
				0.3	32	42	48	52			
				0.5	22	30	35	37			
				0.7	17	24	27	29			
				0.3	82	103	116	127			
				0.5	62	79	89	97			
				0.7	52	66	75	81			
				0.3	33	43	49	53			
				0.5	23	31	36	39			
				0.7	18	25	29	31			
Foot type: L	Rod side flange type: F	Head side flange type: G		0.3	118	148	167	182			
							0.5	90	114	128	140
							0.7	76	95	108	117
				0.3	51	66	75	81			
				0.5	37	49	55	60			
				0.7	30	39	45	49			
Foot type: L	Rod side flange type: F	Head side flange type: G		0.3	168	211	237	259			
							0.5	129	162	183	199
							0.7	109	136	154	168
				0.3	76	97	110	119			
				0.5	56	73	83	90			
				0.7	46	60	68	74			

- 1) In the case where cylinder is used for static action: Load factor $\eta = 0.7$ or less
- 2) In the case where cylinder is used for dynamic action: Load factor $\eta = 0.5$ or less
- 3) In the case where guide is used in horizontal orientation: Load factor $\eta = 0.9$ or less

Sine Cylinder

REC Series

ø20, ø25, ø32, ø40

How to Order

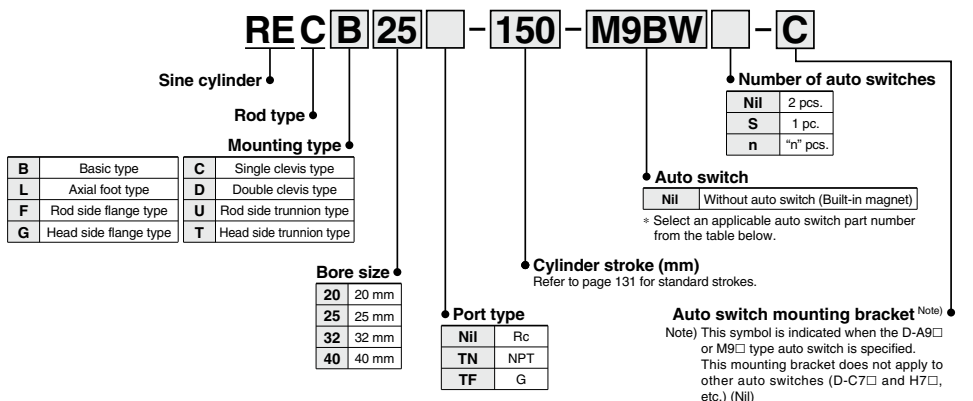

Applicable Auto Switches

Refer to pages 1341 to 1435 for further information on auto switches.

Type	Special function	Electrical entry	Indicator type	Wiring (Output)	Load voltage		Auto switch model		Lead wire length (m)					Pre-wired connector	Applicable load			
					DC	AC	Perpendicular	In-line	0.5 (Nil)	1 (M)	3 (L)	5 (Z)	None (N)					
Solid state auto switch	—	Grommet	No	3-wire (NPN)	5 V, 12 V	—	M9NV	M9N	●	●	●	○	—	○	IC circuit			
				3-wire (PNP)			M9PV	M9P	●	●	●	○	—					
		2-wire		M9BV			M9B	●	●	●	○	—						
		—		—			—	●	●	●	○	—						
	Diagnostic indication (2-color indicator)	Connector	Yes	3-wire (NPN)	24 V	5 V, 12 V	—	M9NWV	M9NW	●	●	●	○	—	○	IC circuit		
				3-wire (PNP)				M9PWV	M9PW	●	●	●	○	—				
	Water resistant (2-color indicator)	Grommet	No	2-wire	12 V	—	—	M9BWW	M9BW	●	●	●	○	—	○	—		
				3-wire (NPN)				M9NAV*1	M9NA*1	○	○	○	○	○	○		IC circuit	
	With diagnostic output (2-color indicator)	Grommet	No	3-wire (PNP)	5 V, 12 V	—	—	M9PAV*1	M9PA*1	○	○	○	○	○	○	IC circuit		
				2-wire				M9BAV*1	M9BA*1	○	○	○	○	○	○			
Reed auto switch	—	Grommet	Yes	4-wire (NPN)	5 V, 12 V	—	—	H7NF	●	—	●	○	—	○	IC circuit			
				—			—	—	●	—	●	○	—					
		Connector		No			2-wire	24 V	12 V	—	A96V	A96	●	●	●	—	—	IC circuit
							—				A93V*2	A93	●	●	●	—	—	
	Grommet	Yes	2-wire	100 V	—	—	A90V	A90	●	●	●	—	—	IC circuit				
							100 V or less	—	—	●	●	●	—		—			
	Connector	No	2-wire	100 V, 200 V	—	—	—	B54	●	—	●	●	—	—	—			
				200 V or less			—	—	●	—	●	●	—					
	Grommet	Yes	2-wire	24 V or less	—	—	—	C73C	●	—	●	●	—	—	IC circuit			
				—			—	—	C80C	●	—	●	●	—				
Grommet	No	2-wire	—	—	—	—	B59W	●	—	●	●	—	—	—				
			—			—	—	—	—	—	—	—	—					

*1 Water resistant type auto switches can be mounted on the above models, but in such case SMC cannot guarantee water resistance.

A water-resistant type cylinder is recommended for use in an environment which requires water resistance. However, please contact SMC for water-resistant products of ø20 and ø25.

*2 1 m type lead wire is only applicable to D-A93.

* Lead wire length symbols: 0.5 m Nil (Example) M9NW
 1 m M (Example) M9NWM
 3 m L (Example) M9NWL
 5 m Z (Example) M9NwZ
 None N (Example) H7CN

* Solid state auto switches marked with "○" are produced upon receipt of order.

* Since there are other applicable auto switches than listed, refer to page 142 for details.

* For details about auto switches with pre-wired connector, refer to pages 1410 and 1411.

* D-A9□(V)/M9□(V)/M9□W(V), M9□A(V) auto switches are shipped together (not assembled). (Only auto switch mounting brackets are assembled before shipped.)

Standard Specifications



Bore size (mm)	20	25	32	40
Action	Double acting, Single rod			
Fluid	Air			
Proof pressure	1.5 MPa			
Maximum operating pressure	1.0 MPa			
Minimum operating pressure	0.2 MPa			
Ambient and fluid temperature	-10 to 60°C			
Piston speed	50 to 500 mm/s			
Cushion	Air cushion (End rubber bumper)			
Effective cushioning stroke (mm)	45	45	50	60
Lubrication	Not required (Non-lube)			
Stroke length tolerance	Up to 1000 st: $^{+1.4}_0$, 1001 to 1500 st: $^{+1.8}_0$			

Symbol
Air cushion

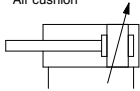

Standard Stroke

Bore size (mm)	Minimum stroke (1) (Recommended)	Standard stroke (2) (mm)	Maximum manufacturable stroke (mm)
20	150	Up to 700	1500
25	150	Up to 700	
32	150	Up to 1000	
40	200	Up to 1000	

Note 1) The recommended minimum strokes or shorter lengths are available. However, since the effective cushion stroke is longer, the cushion performance may differ from the standard specifications.

Note 2) When exceeding the standard strokes, it will be out of warranty.

Weight

Bore size (mm)		20	25	32	40
Basic Weight	Basic type	0.32	0.47	0.74	1.25
	Axial foot type	0.47	0.63	0.90	1.52
	Flange type	0.38	0.56	0.83	1.37
	Single clevis type	0.36	0.51	0.78	1.34
	Double clevis type	0.37	0.53	0.79	1.38
	Trunnion type	0.36	0.54	0.81	1.35
Additional weight per each 50 mm of stroke		0.05	0.07	0.09	0.13
Mounting bracket	Pivot bracket for clevis (With pin)	0.07	0.07	0.14	0.14
	Single knuckle joint	0.06	0.06	0.06	0.23
	Double knuckle joint (With pin)	0.07	0.07	0.07	0.20

* Calculation: (Example) **RECL32-200**
 Basic weight 0.90 (Foot type ø32)
 Additional weight 0.09/50 st
 Cylinder stroke 200 (st)
 $0.90 + 0.09 \times 200/50 = 1.26 \text{ kg}$

Accessory (Option)

Refer to pages 137 and 138 for part numbers and dimensions of the single knuckle joint, double knuckle joint, clevis pin, and knuckle pin.

Mounting Bracket Part No.

Mounting bracket	Minimum order	Bore size (mm)				Description (when ordering a minimum number)
		20	25	32	40	
Axial foot *	2	CM-L020B	CM-L032B	CM-L040B		Foot 2 pcs., Mounting nut 1 pc.
Flange	1	CM-F020B	CM-F032B	CM-F040B		Flange 1 pc.
Single clevis**	1	CM-C020B	CM-C032B	CM-C040B		Single clevis 1 pc., Liner 3 pcs.
Double clevis (With pin)***	1	CM-D020B	CM-D032B	CM-D040B		Double clevis 1 pc., Liner 3 pcs., Clevis pin 1 pc., Retaining ring 2 pcs.
Trunnion (With nut)	1	CM-T020B	CM-T032B	CM-T040B		Trunnion 1 pc., Trunnion nut 1 pc.

* When ordering foot bracket, order 2 pieces per cylinder.

** 3 liners are included in the clevis bracket for adjusting an angle when mounting it.

*** Clevis pin and retaining ring (cotter pin for ø40) are packaged together.

REC Series

Construction

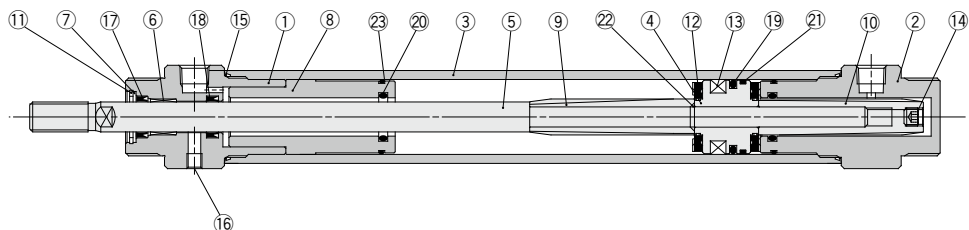

Component Parts

No.	Description	Material	Qty.	Note
1	Rod cover	Aluminum alloy	1	Anodized
2	Head cover	Aluminum alloy	1	Anodized
3	Cylinder tube	Aluminum alloy	1	Hard anodized
4	Piston	Aluminum alloy	1	
5	Piston rod	Stainless steel	1	Hard chrome plated
6	Bushing	Bearing alloy	1	
7	Seal retainer	Stainless steel	1	
8	Cushion seal holder	Aluminum alloy	1	Chromated
9	Cushion ring A	Brass	1	Electroless nickel plated
10	Cushion ring B	Brass	1	Electroless nickel plated
11	Retaining ring	Carbon steel	1	Phosphate coated
12	Bumper	Resin	2	
13	Magnet	—	1	
14	Hexagon socket head set screw	Carbon steel	1	Zinc chromated
15	Cylinder tube gasket	NBR	2	
16	Hexagon socket head set screw	Carbon steel	1	Zinc chromated

Component Parts

No.	Description	Material	Qty.	Note
17	Rod seal A	NBR	1	
18	Rod seal B	NBR	1	
19	Piston seal	NBR	1	
20	Cushion seal	NBR	2	
21	Wear ring	Resin	1	
22	Piston gasket	NBR	1	
23	Holder gasket	NBR	2	

Replacement Parts/Seal Kit

Bore size (mm)	Kit no.	Contents
20	REC20-PS	Set of nos. above (15, 17, 19, 20, 21, 23)
25	REC25-PS	
32	REC32-PS	
40	REC40-PS	

* Seal kit includes a grease pack (10 g).

Order with the following part number when only the grease pack is needed.

Grease pack part no.: GR-S-010 (10 g)

⚠ Caution

When disassembling cylinders with bore sizes of $\phi 20$ to $\phi 40$, grip the double flat part of either the tube cover or the rod cover with a vise and loosen the other side with a wrench or an adjustable angle wrench, and then remove the cover. When re-tightening, tighten approximately 2 degrees more than the original position.

Working Principle

1. Start-up

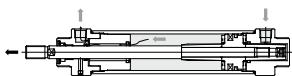

Actuating air passes from cylinder port on head side and enters the right hand side of chamber of the cylinder from space between cushion seal and U-shaped groove on the outer surface of cushion spear. Air in the left hand side of chamber of the cylinder passes through space between cushion seal and piston rod, and is released to the cylinder port on rod side.

2. In-rush/acceleration



Differential pressure (theoretical force) generated on the left and right sides of piston becomes larger than starting resistance, and piston starts to actuate. With the actuation, U-shaped groove on the cushion spear outer surface gradually becomes deeper, air flow necessary for piston enters the right hand side of chamber of the cylinder, and piston accelerates. This acceleration process can be achieved smoothly (as a sine function) by using a cushion spear on which a U-shaped groove is machined.

3. Acceleration



When piston starts to actuate, air can go in and out freely because cushion spear on head side is released from cushion seal. With this actuation, piston speed accelerates (or maintains the same speed).

4. Deceleration

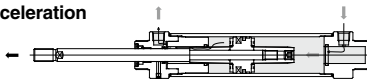

When cushion spear on rod side meets cushion seal, air in cushion chamber on rod side flows through space between cushion spear groove and cushion seal.

Since the space is reduced as a sine function, the cylinder rod decelerates smoothly.

5. Stop



The piston stops at the stroke end on rod side with smooth cushioning. Air flow which is switched by solenoid valve is reversed from the one indicated in the above "1. Start-up".

6. Reset

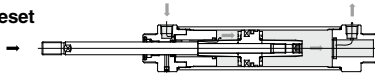

Actuating air passes from cylinder port on rod side and enters the left chamber of the cylinder from space between cushion seal and U-shaped groove on the outer surface of cushion spear. Also, air in right hand side of chamber of piston is exhausted from cylinder port. As U-shaped groove on the cushion spear outer surface gradually becomes deeper, the cylinder accelerates.

Clean Series

10 — REC **Mounting type** **Bore size** — **Stroke**

Clean Series

10	Relief type
11	Vacuum type

The type which is applicable for using inside the clean room graded ISO Class 4 by making an actuator's rod section a double seal construction and discharging by relief port directly to the outside of clean room.
The plug (M5 x 0.8) in the standard dimensions becomes a relief port.



For detailed specifications about the clean series, refer to the **Web Catalog**.

Specifications

Action	Double acting, Single rod
Bore size	ø20, ø25, ø32, ø40
Maximum operating pressure	1.0 MPa
Minimum operating pressure	0.2 MPa
Cushion	Air cushion
Relief port size	M5 x 0.8
Piston speed	50 to 400 mm/s
Mounting	Basic type, Axial foot type, Rod side flange type, Head side flange type

* Auto switch can be mounted.

Dimensions

Basic type: RECB

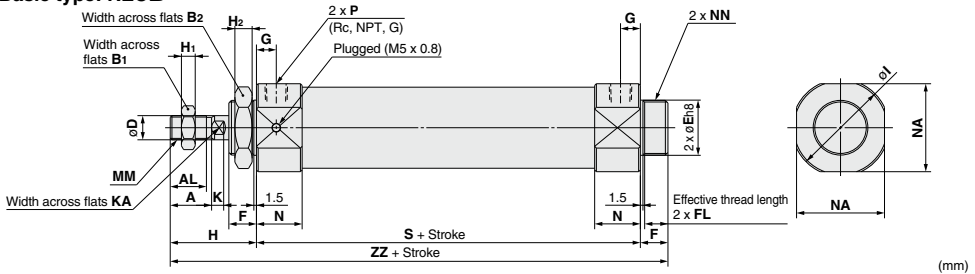

Bore (mm)	A	AL	B ₁	B ₂	D	E	F	FL	G	H	H ₁	H ₂	I	K	KA	MM	N	NA	NN	P	S	ZZ
20	18	15.5	13	26	8	20 ⁰ _{-0.033}	13	10.5	10	41	5	8	33.5	5	6	M8 x 1.25	20	30	M20 x 1.5	1/8	146	200
25	22	19.5	17	32	10	26 ⁰ _{-0.033}	13	10.5	10	45	6	8	37.5	5.5	8	M10 x 1.25	20	34.5	M26 x 1.5	1/8	146	204
32	22	19.5	17	32	12	26 ⁰ _{-0.033}	13	10.5	11	45	6	8	46.5	5.5	10	M10 x 1.25	22	42.5	M26 x 1.5	1/8	159	217
40	24	21	22	41	14	32 ⁰ _{-0.039}	16	13.5	12.5	50	8	10	56	7	12	M14 x 1.5	26.5	51	M32 x 2	1/4	181	247

Axial foot type: RECL

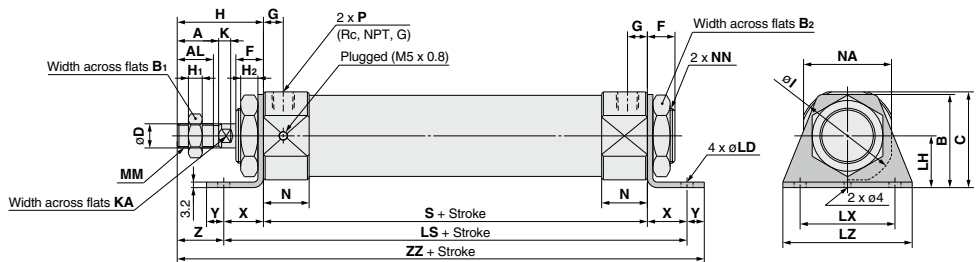

Bore (mm)	A	AL	B	B ₁	B ₂	C	D	F	G	H	H ₁	H ₂	I	K	KA	LD	LH	LS	LX	LZ	MM	N	NA
20	18	15.5	40	13	26	40	8	13	10	41	5	8	33.5	5	6	6.8	25	186	40	55	M8 x 1.25	20	30
25	22	19.5	47	17	32	45.5	10	13	10	45	6	8	37.5	5.5	8	6.8	28	186	40	55	M10 x 1.25	20	34.5
32	22	19.5	47	17	32	49.5	12	13	11	45	6	8	46.5	5.5	10	6.8	28	199	40	55	M10 x 1.25	22	42.5
40	24	21	54	22	41	55.5	14	16	12.5	50	8	10	56.2	7	12	7	30	227	55	75	M14 x 1.5	26.5	51

Bore (mm)	NN	P	S	X	Y	Z	ZZ
20	M20 x 1.5	1/8	146	20	8	21	215
25	M26 x 1.5	1/8	146	20	8	25	219
32	M26 x 1.5	1/8	159	20	8	25	232
40	M32 x 2	1/4	181	23	10	27	264

* Bracket is shipped together with the product.

REC Series

Dimensions

Rod side flange type: REC F

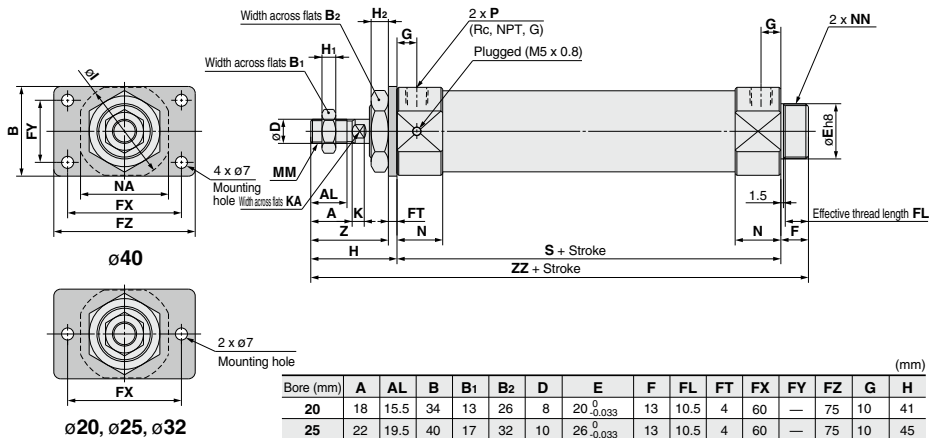

Bore (mm)	A	AL	B	B ₁	B ₂	D	E	F	FL	FT	FX	FY	FZ	G	H
20	18	15.5	34	13	26	8	20 ⁰ _{-0.033}	13	10.5	4	60	—	75	10	41
25	22	19.5	40	17	32	10	26 ⁰ _{-0.033}	13	10.5	4	60	—	75	10	45
32	22	19.5	40	17	32	12	26 ⁰ _{-0.033}	13	10.5	4	60	—	75	11	45
40	24	21	52	22	41	14	32 ⁰ _{-0.039}	16	13.5	5	66	36	82	12.5	50

Bore (mm)	H ₁	H ₂	I	K	KA	MM	N	NA	NN	P	S	Z	ZZ
20	5	8	33.5	5	6	M8 x 1.25	20	30	M20 x 1.5	1/8	146	37	200
25	6	8	37.5	5.5	8	M10 x 1.25	20	34.5	M26 x 1.5	1/8	146	41	204
32	6	8	46.5	5.5	10	M10 x 1.25	22	42.5	M26 x 1.5	1/8	159	41	217
40	8	10	56.2	7	12	M14 x 1.5	26.5	51	M32 x 2	1/4	181	45	247

* Bracket is shipped together with the product.

Head side flange type: REC G

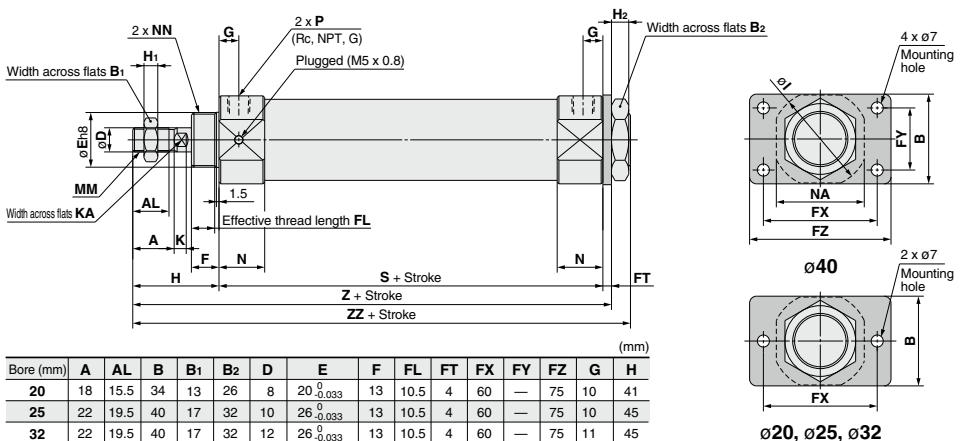

Bore (mm)	A	AL	B	B ₁	B ₂	D	E	F	FL	FT	FX	FY	FZ	G	H
20	18	15.5	34	13	26	8	20 ⁰ _{-0.033}	13	10.5	4	60	—	75	10	41
25	22	19.5	40	17	32	10	26 ⁰ _{-0.033}	13	10.5	4	60	—	75	10	45
32	22	19.5	40	17	32	12	26 ⁰ _{-0.033}	13	10.5	4	60	—	75	11	45
40	24	21	52	22	41	14	32 ⁰ _{-0.039}	16	13.5	5	66	36	82	12.5	50

Bore (mm)	H ₁	H ₂	I	K	KA	MM	N	NA	NN	P	S	Z	ZZ
20	5	8	33.5	5	6	M8 x 1.25	20	30	M20 x 1.5	1/8	146	191	200
25	6	8	37.5	5.5	8	M10 x 1.25	20	34.5	M26 x 1.5	1/8	146	195	204
32	6	8	46.5	5.5	10	M10 x 1.25	22	42.5	M26 x 1.5	1/8	159	208	217
40	8	10	56.2	7	12	M14 x 1.5	26.5	51	M32 x 2	1/4	181	236	247

* Bracket is shipped together with the product.

Dimensions

Single clevis type: RECC

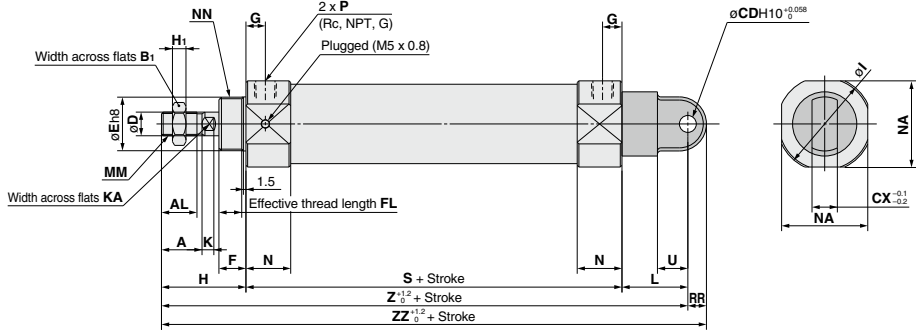

Bore (mm)	A	AL	B1	CD	CX	D	E	F	FL	G	H	H1	I	K	KA	L	MM	N
20	18	15.5	13	9	10	8	20 ⁰ _{-0.033}	13	10.5	10	41	5	33.5	5	6	30	M8 x 1.25	20
25	22	19.5	17	9	10	10	26 ⁰ _{-0.033}	13	10.5	10	45	6	37.5	5.5	8	30	M10 x 1.25	20
32	22	19.5	17	9	10	12	26 ⁰ _{-0.033}	13	10.5	11	45	6	46.5	5.5	10	30	M10 x 1.25	22
40	24	21	22	10	15	14	32 ⁰ _{-0.039}	16	13.5	12.5	50	8	56.2	7	12	39	M14 x 1.5	26.5

Bore (mm)	NA	NN	P	RR	S	U	Z	ZZ
20	30	M20 x 1.5	1/8	9	146	14	217	226
25	34.5	M26 x 1.5	1/8	9	146	14	221	230
32	42.5	M26 x 1.5	1/8	9	159	14	234	243
40	51	M32 x 2	1/4	11	181	18	270	281

Double clevis type: RECD

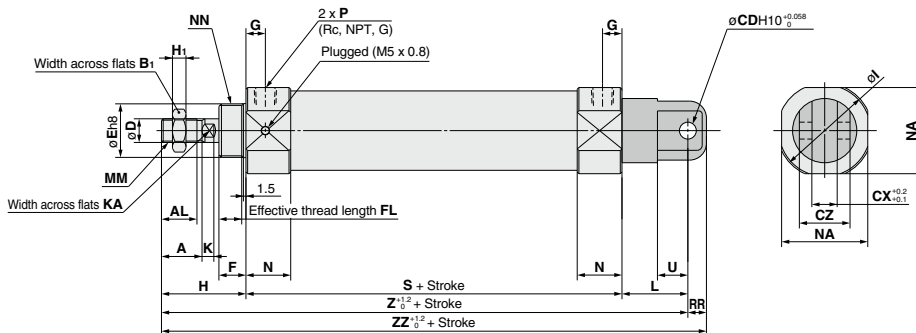

Bore (mm)	A	AL	B1	CD	CX	CZ	D	E	F	FL	G	H	H1	I	K	KA	L	MM
20	18	15.5	13	9	10	19	8	20 ⁰ _{-0.033}	13	10.5	10	41	5	33.5	5	6	30	M8 x 1.25
25	22	19.5	17	9	10	19	10	26 ⁰ _{-0.033}	13	10.5	10	45	6	37.5	5.5	8	30	M10 x 1.25
32	22	19.5	17	9	10	19	12	26 ⁰ _{-0.033}	13	10.5	11	45	6	46.5	5.5	10	30	M10 x 1.25
40	24	21	22	10	15	30	14	32 ⁰ _{-0.039}	16	13.5	12.5	50	8	56.2	7	12	39	M14 x 1.5

Bore (mm)	N	NA	NN	P	RR	S	U	Z	ZZ
20	20	30	M20 x 1.5	1/8	9	146	14	217	226
25	20	34.5	M26 x 1.5	1/8	9	146	14	221	230
32	22	42.5	M26 x 1.5	1/8	9	159	14	234	243
40	26.5	51	M32 x 2	1/4	11	181	18	270	281

REC Series

Dimensions

Rod side trunnion type: REC U

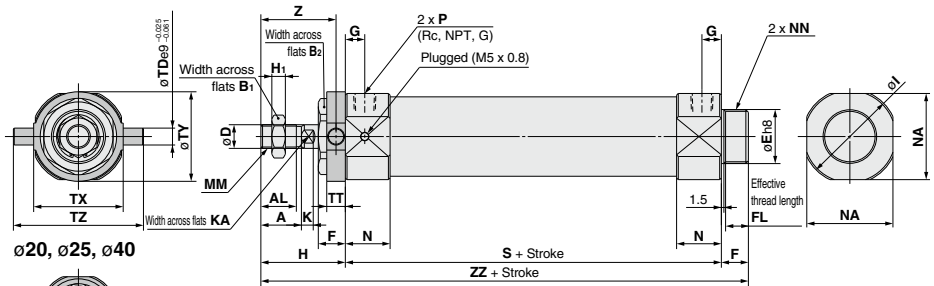

ø20, ø25, ø40

ø32

Note) For ø32, a trunnion pivot bracket NA (42.5) is used as standard.

														(mm)													
Bore (mm)	A	AL	B ₁	B ₂	D	E	F	FL	G	H	H ₁	I	K	KA	MM	N	NA	NN	P	S	TD	TT	TX	TY	TZ	Z	ZZ
20	18	15.5	13	26	8	20 ⁰ _{-0.033}	13	10.5	10	41	5	33.5	5	6	M8 x 1.25	20	30	M20 x 1.5	1/8	146	8	10	32	32	52	36	200
25	22	19.5	17	32	10	26 ⁰ _{-0.033}	13	10.5	10	45	6	37.5	5.5	8	M10 x 1.25	20	34.5	M26 x 1.5	1/8	146	9	10	40	40	60	40	204
32	22	19.5	17	32	12	26 ⁰ _{-0.033}	13	10.5	11	45	6	46.5	5.5	10	M10 x 1.25	22	42.5	M26 x 1.5	1/8	159	9	10	40	40	60	40	217
40	24	21	22	41	14	32 ⁰ _{-0.039}	16	13.5	12.5	50	8	56.2	7	12	M14 x 1.5	26.5	51	M32 x 2	1/4	181	10	11	53	53	77	44.5	247

* Bracket is shipped together with the product.

Head side trunnion type: RECT

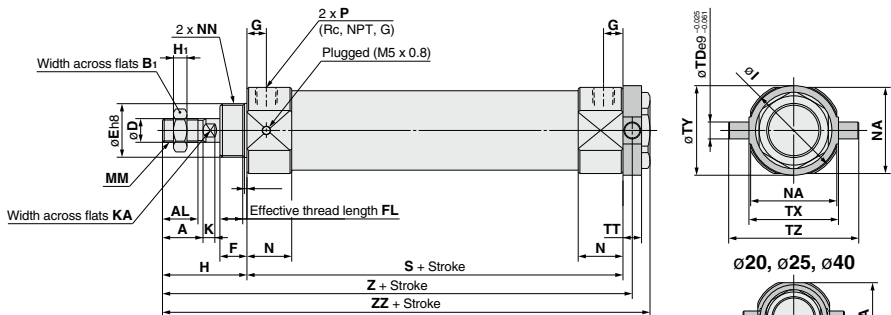

ø20, ø25, ø40

ø32

Note) For ø32, a trunnion pivot bracket NA (42.5) is used as standard.

																(mm)										
Bore (mm)	A	AL	B ₁	D	E	F	FL	G	H	H ₁	I	K	KA	MM	N	NA	NN	P	S	TD	TT	TX	TY	TZ	Z	ZZ
20	18	15.5	13	8	20 ⁰ _{-0.033}	13	10.5	10	41	5	33.5	5	6	M8 x 1.25	20	30	M20 x 1.5	1/8	146	8	10	32	32	52	192	202
25	22	19.5	17	10	26 ⁰ _{-0.033}	13	10.5	10	45	6	37.5	5.5	8	M10 x 1.25	20	34.5	M26 x 1.5	1/8	146	9	10	40	40	60	196	206
32	22	19.5	17	12	26 ⁰ _{-0.033}	13	10.5	11	45	6	46.5	5.5	10	M10 x 1.25	22	42.5	M26 x 1.5	1/8	159	9	10	40	40	60	209	219
40	24	21	22	14	32 ⁰ _{-0.039}	16	13.5	12.5	50	8	56.2	7	12	M14 x 1.5	26.5	51	M32 x 2	1/4	181	10	11	53	53	77	236.5	247

* Bracket is shipped together with the product.

Accessory Dimensions 1

Single Knuckle Joint Mounting

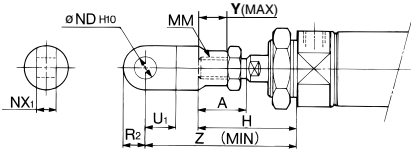

Bore (mm)	A	H	MM	ND H10	NX1	U1	R2	Y	Z
20	18	41	M8 x 1.25	9 ^{+0.058} / ₀	9 ^{-0.1} / _{-0.2}	14	10	11	66
25, 32	22	45	M10 x 1.25	9 ^{+0.058} / ₀	9 ^{-0.1} / _{-0.2}	14	10	14	69
40	24	50	M14 x 1.5	12 ^{+0.070} / ₀	16 ^{-0.1} / _{-0.3}	20	14	13	92

Single Knuckle Joint

I-020B, 032B Material: Rolled steel I-040B Material: Free cutting sulfur steel

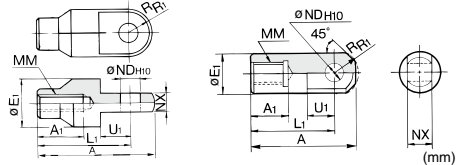

Part no.	Applicable bore size (mm)	A	A1	E1	L1	MM	ND H10	NX	R1	U1
I-020B	20	46	16	20	36	M8 x 1.25	9 ^{+0.058} / ₀	9 ^{-0.1} / _{-0.2}	10	14
I-032B	25, 32	48	18	20	38	M10 x 1.25	9 ^{+0.058} / ₀	9 ^{-0.1} / _{-0.2}	10	14
I-040B	40	69	22	24	55	M14 x 1.5	12 ^{+0.070} / ₀	16 ^{-0.1} / _{-0.3}	15.5	20

Double Knuckle Joint Mounting

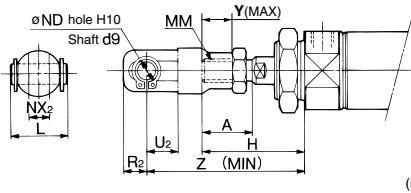

Bore (mm)	A	H	L	MM	ND	NX2	R2	U2	Y	Z
20	18	41	25	M8 x 1.25	9	9 ^{+0.2} / _{-0.1}	10	14	11	66
25, 32	22	45	25	M10 x 1.25	9	9 ^{+0.2} / _{-0.1}	10	14	14	69
40	24	50	49.7	M14 x 1.5	12	16 ^{+0.3} / _{-0.1}	13	25	13	92

Double Knuckle Joint

Y-020B, Y-032B Material: Rolled steel

Y-040B Material: Cast iron

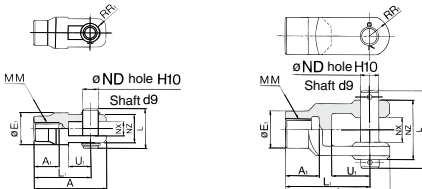

Part no.	Applicable bore size (mm)	A	A1	E1	L	L1	MM	ND	NX	NZ	R1	U1	Applicable pin part no.	Retaining ring C9 for shaft	Retaining ring Size
Y-020B	20	46	16	20	25	36	M8 x 1.25	9	9 ^{+0.2} / _{-0.1}	18	5	14	CDP-1	Type C9 for shaft	
Y-032B	25, 32	48	18	20	25	38	M10 x 1.25	9	9 ^{+0.2} / _{-0.1}	18	5	14	CDP-1	Type C9 for shaft	
Y-040B	40	68	22	24	49.7	55	M14 x 1.5	12	16 ^{+0.3} / _{-0.1}	38	13	25	CDP-3	ø3 x 18 L	

* Knuckle pins and retaining rings (cotter pins for ø40) are included.

Double Clevis Pin/Material: Carbon steel

Bore size/ø20, ø25, ø32

CDP-1

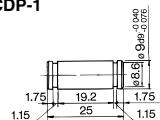

Retaining ring: Type C9 for shaft

Bore size/ø40

CDP-2

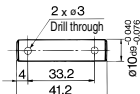

Cotter pin: ø3 x 18 L

* Retaining rings (cotter pins for ø40) are included.

Double Knuckle Pin/Material: Carbon steel

Bore size/ø20, ø25, ø32

CDP-1

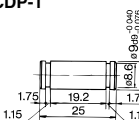

Retaining ring: Type C9 for shaft

Bore size/ø40

CDP-3

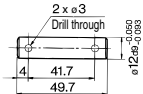

Cotter pin: ø3 x 18 L

* Retaining rings (cotter pins for ø40) are included.

REC Series

Accessory Dimensions 2

Rod End Nut

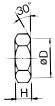

Material: Carbon steel

(mm)

Part no.	Applicable bore size (mm)	B	C	D	d	H
NT-02	20	13	15.0	12.5	M8 x 1.25	5
NT-03	25, 32	17	19.6	16.5	M10 x 1.25	6
NT-04	40	22	25.4	21.0	M14 x 1.5	8

Mounting Nut

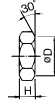

Material: Carbon steel

(mm)

Part no.	Applicable bore size (mm)	B	C	D	d	H
SN-020B	20	26	30	25.5	M20 x 1.5	8
SN-032B	25, 32	32	37	31.5	M26 x 1.5	8
SN-040B	40	41	47.3	40.5	M32 x 2.0	10

Trunnion Nut

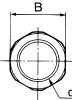
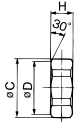

Material: Carbon steel

(mm)

Part no.	Applicable bore size (mm)	B	C	D	d	H
TN-020B	20	26	28	25.5	M20 x 1.5	10
TN-032B	25, 32	32	34	31.5	M26 x 1.5	10
TN-040B	40	41	45	40.5	M32 x 2	10

Refer to page 1512 (CM2-XB12: External stainless steel cylinder) for stainless steel mounting brackets and accessories (some are not applicable).

* Same mounting brackets and accessories are used as CM2 series (**Web Catalog**).

Auto Switch Mounting 1

Minimum Stroke for Auto Switch Mounting

Auto switch model	No. of auto switches mounted				n: No. of auto switches (mm)	
	1	2		n		
		Different surfaces	Same surface	Different surfaces	Same surface	
D-M9□	5	15 Note 1)	40 Note 1)	$20 + 35 \frac{(n-2)}{2}$ (n = 2, 4, 6...) Note 3)	55 + 35 (n - 2) (n = 2, 3, 4, 5...)	
D-M9□W	10	15 Note 1)	40 Note 1)	$20 + 35 \frac{(n-2)}{2}$ (n = 2, 4, 6...) Note 3)	55 + 35 (n - 2) (n = 2, 3, 4, 5...)	
D-M9□A	10	25	40 Note 1)	$25 + 35 \frac{(n-2)}{2}$ (n = 2, 4, 6...) Note 3)	60 + 35 (n - 2) (n = 2, 3, 4, 5...)	
D-A9□	5	15	30 Note 1)	$15 + 35 \frac{(n-2)}{2}$ (n = 2, 4, 6...) Note 3)	50 + 35 (n - 2) (n = 2, 3, 4, 5...)	
D-M9□V	5	20	35	$20 + 35 \frac{(n-2)}{2}$ (n = 2, 4, 6...) Note 3)	35 + 35 (n - 2) (n = 2, 3, 4, 5...)	
D-A9□V	5	15	25	$15 + 35 \frac{(n-2)}{2}$ (n = 2, 4, 6...) Note 3)	25 + 35 (n - 2) (n = 2, 3, 4, 5...)	
D-M9□WV D-M9□AV	10	20	35	$20 + 35 \frac{(n-2)}{2}$ (n = 2, 4, 6...) Note 3)	35 + 35 (n - 2) (n = 2, 3, 4, 5...)	
D-C7□ D-C80	5	20	60	$20 + 45 \frac{(n-2)}{2}$ (n = 2, 4, 6...) Note 3)	60 + 45 (n - 2) (n = 2, 3, 4, 5...)	
D-H7□ D-H7□W D-H7BA D-H7NF	10	25	70	$25 + 45 \frac{(n-2)}{2}$ (n = 2, 4, 6...) Note 3)	70 + 45 (n - 2) (n = 2, 3, 4, 5...)	
D-C73C D-C80C D-H7C	5	30	80	$30 + 50 \frac{(n-2)}{2}$ (n = 2, 4, 6...) Note 3)	80 + 50 (n - 2) (n = 2, 3, 4, 5...)	
D-B5□ D-B64 D-G5□ D-K59□	5	25	70	$25 + 50 \frac{(n-2)}{2}$ (n = 2, 4, 6...) Note 3)	70 + 50 (n - 2) (n = 2, 3, 4, 5...)	
D-B59W	10	30	75	$30 + 50 \frac{(n-2)}{2}$ (n = 2, 4, 6...) Note 3)	75 + 50 (n - 2) (n = 2, 3, 4, 5...)	

Note 3) When "n" is an odd number, an even number that is one larger than this odd number is used for the calculation.

Note 1) Auto switch mounting

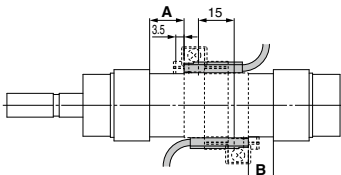
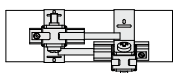
Auto switch model	With 2 auto switches	
	Different surfaces	Same surface
 <p>Correct auto switch mounting position is 3.5 mm from the back face of the switch holder.</p>	 <p>The auto switch is mounted by slightly displacing it in a direction (cylinder tube circumferential exterior) so that the auto switch and lead wire do not interfere with each other.</p>	
D-M9□ D-M9□W	Less than 20 stroke Note 2)	Less than 55 stroke Note 2)
D-M9□A	Less than 25 stroke Note 2)	Less than 60 stroke Note 2)
D-A9□	—	Less than 50 stroke Note 2)

Note 2) Minimum stroke for auto switch mounting in types other than those mentioned in Note 1.

Auto Switch Mounting 2

Auto Switch Proper Mounting Position (Detection at Stroke End) and Its Mounting Height

Reed auto switch

D-A9□

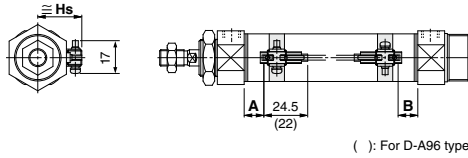

D-C7□, C80

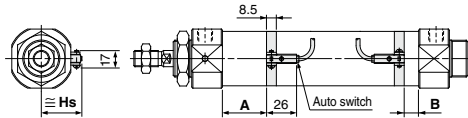

D-C73C, C80C

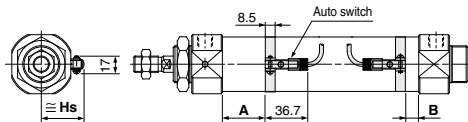

D-B5□, B64, B59W

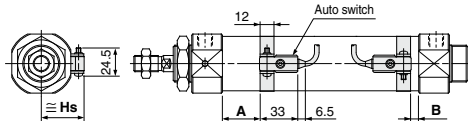

D-A44

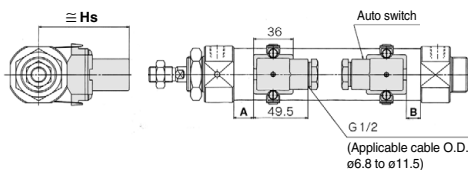

Solid state auto switch

D-M9□
D-M9□A
D-M9□W

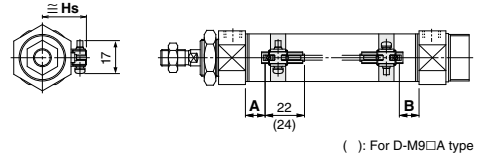

D-G5NT

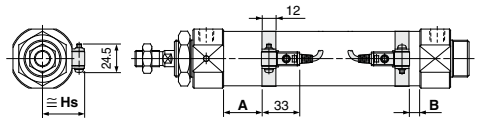

D-H7□, H7□W, H7NF, H7BA

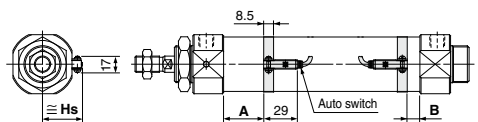

D-H7C

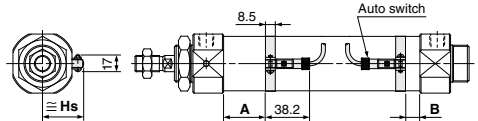

D-A3□, G39, K39

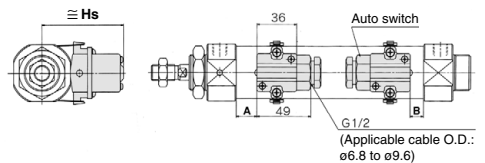

Auto Switch Proper Mounting Position (Detection at Stroke End) and Its Mounting Height

Auto Switch Proper Mounting Position

(mm)

Auto Switch model Bore size (mm)	D-M9□(V) D-M9□W(V) D-M9□A(V)		D-A9□(V)		D-C7/C8 D-C73C D-C80C		D-B5 D-B6		D-B59W		D-A3□ D-G39 D-K39 D-A44		D-H7□ D-H7C D-H7□W D-H7BA D-H7NF		D-G5NT	
	A	B	A	B	A	B	A	B	A	B	A	B	A	B	A	B
	20	59.5	34	55.5	30.5	56	31	50	25	53	28	49.5	24.5	55	30	51.5
25	59.5	34	55.5	30.5	56	31	50	25	53	28	49.5	24.5	55	30	51.5	26.5
32	63	40	59	36	59.5	36.5	53.5	30.5	56.5	33.5	53	30	58.5	35.5	55	32
40	73.5	42.5	69.5	38.5	70	39	64	33	67	36	63.5	32.5	69	38	65.5	34.5

Note) Adjust the auto switch after confirming the operating conditions in the actual setting.

Auto Switch Mounting Height

(mm)

Auto Switch model Bore size (mm)	D-M9□(V) D-M9□W(V) D-M9□A(V) D-A9□(V)		D-C7/C8 D-H7□ D-H7□W D-H7NF D-H7BA		D-B5□ D-B64 D-B59W D-G5NT D-H7C		D-C73C D-C80C		D-A3□ D-G39 D-K39		D-A44	
	Hs	Hs	Hs	Hs	Hs	Hs	Hs	Hs	Hs	Hs	Hs	Hs
20	25	24.5	27.5	27	62	72						
25	27.5	27	30	29.5	64.5	74.5						
32	31	30.5	33.5	33	68	78						
40	35.5	35	38	37.5	72.5	82.5						

Auto Switch Mounting 3

Operating Range

Auto switch model	Bore size (mm)			
	20	25	32	40
D-A9□	7	6	8	8
D-M9□	4	4	5	4
D-M9□W				
D-C7□/C80	8	10	9	10
D-C73C/C80C				
D-B5□/B64	8	10	9	10
D-B59W				
D-H7□/H7□W	4	4	4.5	5
D-H7NF/H7BA				
D-H7C	7	8.5	9	10
D-A3□/D-A44				
D-G39/D-K39	8	9	9	9
D-G5NT	4	4	4.5	5
D-G5NB	35	40	40	45

* Since this is a guideline including hysteresis, not meant to be guaranteed. (assuming approximately ±30% dispersion.)
There may be the case it will vary substantially depending on an ambient environment.

Auto Switch Mounting Bracket Part No.

Auto switch model	Bore size (mm)			
	φ20	φ25	φ32	φ40
D-A9□(V) D-M9□(V) D-M9□W(V)	Note1) BMA3-020 (A set of a, b, c, d)	Note1) BMA3-025 (A set of a, b, c, d)	Note1) BMA3-032 (A set of a, b, c, d)	Note1) BMA3-040 (A set of a, b, c, d)
D-M9□A(V) Note 2)	BMA3-020S (A set of b, c, e, f)	BMA3-025S (A set of b, c, e, f)	BMA3-032S (A set of b, c, e, f)	BMA3-040S (A set of b, c, e, f)
D-H7□ D-H7□W D-H7NF D-C7□/C80 D-C73C/C80C	BMA2-020A (A set of c and d)	BMA2-025A (A set of c and d)	BMA2-032A (A set of c and d)	BMA2-040A (A set of c and d)
D-H7BA	BMA2-020AS (A set of c and f)	BMA2-025AS (A set of c and f)	BMA2-032AS (A set of c and f)	BMA2-040AS (A set of c and f)
D-B5□/B64 D-B59W D-G5□/K59 D-G5□W/K59W D-G5BA/G59F D-G5NT	BA-01 (A set of c and d)	BA-02 (A set of c and d)	BA-32 (A set of c and d)	BA-04 (A set of c and d)

Note 1) Since the switch bracket (made from nylon) are affected in an environment where alcohol, chloroform, methylamines, hydrochloric acid or sulfuric acid is splashed over, so it cannot be used. Please consult SMC regarding other chemicals.

Note 2) When mounting a D-M9□A(V) type auto switch, if the switch bracket is mounted on the indicator light, it may damage the auto switch. Therefore, be sure to avoid mounting the switch bracket on the indicator light.

[Mounting screw set made of stainless steel]

The following set of mounting screws made of stainless steel is available. Use it in accordance with the operating environment. (Please order the auto switch mounting bracket separately, since it is not included.)

BBA4: For D-C7/C8/H7

Note) Refer to page 1440 for details of the BBA4. The above stainless steel screws are used when a cylinder is shipped with the D-H7BA auto switch. When only an auto switch is shipped independently, the BBA4 is attached.

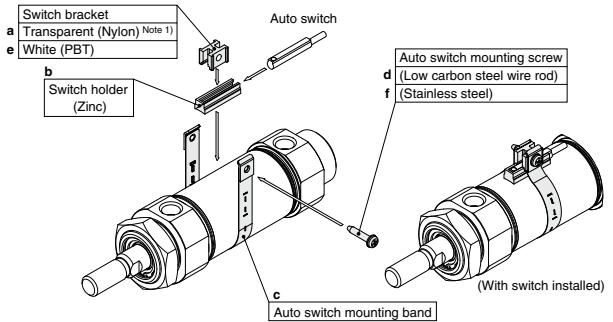

* Band (c) is mounted so that the projected part is on the internal side (contact side with the tube).

Other than the applicable auto switches listed in "How to Order", the following auto switches can be mounted.

For detailed specifications, refer to pages 1341 to 1435.

Auto switch type	Model	Electrical entry (Fetching direction)	Features	Applicable bore size
Reed	D-C73, C76	Grommet (In-line)	—	φ20 to φ40
	D-C80		Without indicator light	
	D-B53		—	
Solid state	D-H7A1, H7A2, H7B		—	φ20 to φ40
	D-H7NW, H7PW, H7BW		—	
	D-G5NT		Diagnostic indication (2-color indicator)	φ20 to φ40
		With timer		

* For solid state auto switches, auto switches with a pre-wired connector are also available. Refer to pages 1410 and 1411 for details.

* Normally closed (NC = b contact) solid state auto switches (D-M9□E(V)) are also available. Refer to page 1360 for details.



REC Series Specific Product Precautions

Be sure to read this before handling the products.

Refer to page 9 for safety instructions and pages 10 to 19 for actuator and auto switch precautions.

⚠ Caution

1. Speed Adjustment

Throttle speed controller, such as AS series, is recommended for speed adjustment.

Recommended Speed Controller with One-touch Fitting

Model	Model		
	Elbow type	Universal type	In-line type
REC20	AS2201F-01-06A-X214	AS2301F-01-06A-X214	AS2002F-06A-X214
REC25	AS2201F-01-06A-X214	AS2301F-01-06A-X214	AS2002F-06A-X214
REC32	AS2201F-01-06A-X214	AS2301F-01-06A-X214	AS3002F-08A-X214
REC40	AS3201F-02-08A-X214	AS3301F-02-08A-X214	AS3002F-08A-X214

Symbol: Throttle valve



- Speed control is possible with meter-in and meter-out types of speed controllers. However, smooth acceleration and deceleration may not be obtained by these speed controllers.
- For installation other than horizontal mounting, it is recommended to use a system with reduced pressure supply circuit on the downward side. (This system is also effective for avoiding a start delay at rise and air consumption.)

2. Cushion Adjustment

Cushion adjustment mechanism is not designed.

Cushion adjustment is not necessary because the model can perform smooth acceleration and deceleration in a wide range of strokes without an adjusting cushion.

3. Plug (Relief Port)

For general conditions, a plug (M5 x 0.8) on the rod cover side is plugged with a hexagon socket head set screw . Do not remove it since dust may enter inside.

Hexagon socket set screw is not prepared for clean room specifications, and use it as relief port accordingly.

4. Cycle Time

Due to the nature of its construction, this cylinder starts and stops gradually. Therefore, the length of time for the stroke could be longer than that of standard cylinders.