

Air Slide Table/Long Stroke Type

*MX*Y Series

ø6, ø8, ø12

RoHS

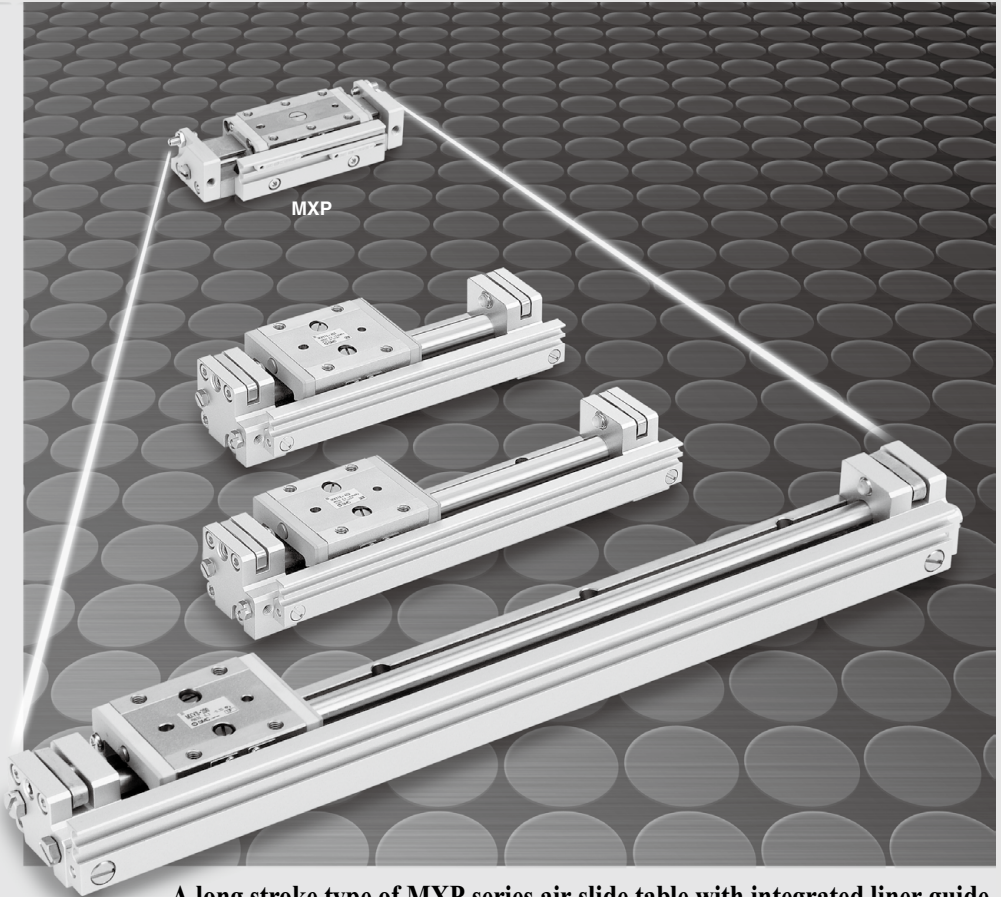

A long stroke type of MXP series air slide table with integrated liner guide.

Use of linear guide provides rigid, The slide table comes with a built-in

Rigid, compact, and lightweight

Compact design with higher allowable moment compared to MXY8/MXW8

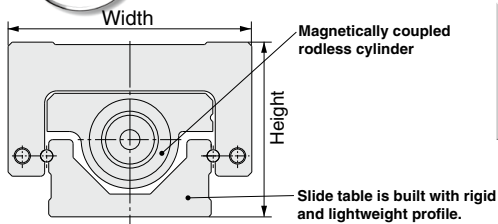

Model	Height mm	Width mm	Weight g	Allowable moment N·m		
				Pitch, Yaw	Roll	
MXY8-50	25	47	420	5.7	13	
MXW8-50	30	49	610	5	3	
MXY/MXW	0.8 times	0.95 times	0.7 times	1.14 times	4 times	

Model	Height mm	Width mm	Weight g*
MXY6	21.5	30	270
MXY8	25	38	420
MXY12	36	50	930

*Values for 50 mm stroke

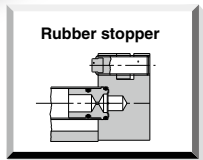
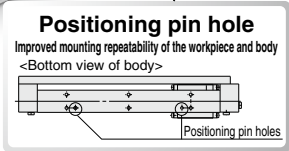
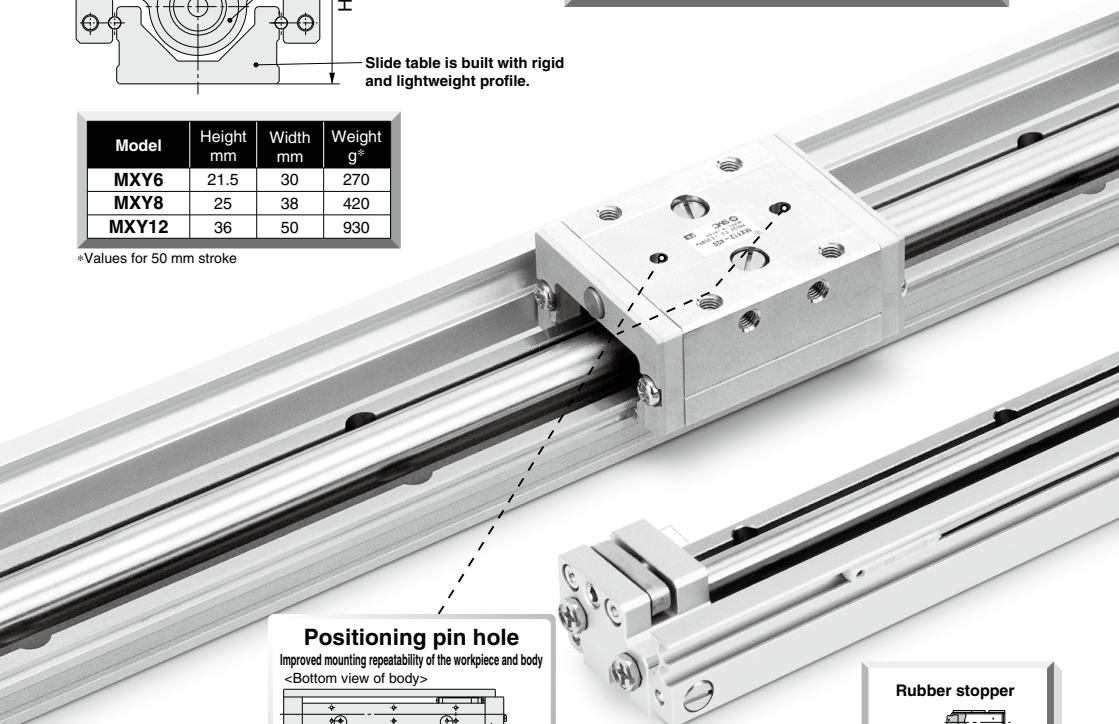

Adjuster options

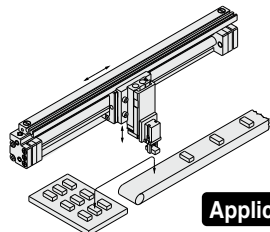
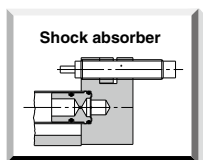
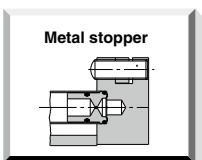

Application Example

compact, and lightweight design. magnetically coupled rodless cylinder.



Long stroke

MXY12—Max. stroke 400 mm

Series variations

Bore size (mm)	Stroke							Adjuster options			Function options	
	50	100	150	200	250	300	350	400	Rubber stopper	Shock absorber	Metal stopper	Piping concentrated on one side of the switch rail
6	●	●	●	●	●	●	●	●	●	●	●	●
8	●	●	●	●	●	●	●	●	●	●	●	●
12	●	●	●	●	●	●	●	●	●	●	●	●

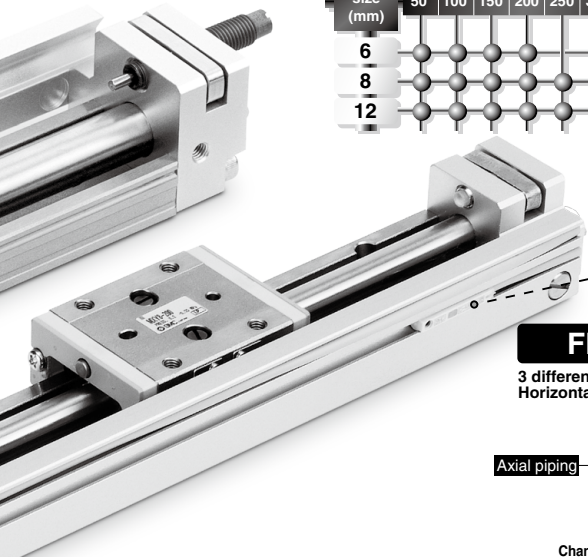

Auto switch mounting

Three types of auto switches can be mounted.

Solid state auto switch: M9 type

Reed auto switch: A9 type

2-color indicator solid state auto switch: M9□W type

Flexible Piping

3 different piping directions are available:

Horizontal piping, axial piping, and centralized piping

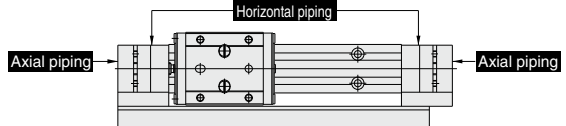

Changing the mounting position of the switch rail, which also used as an air passage can change the direction of the centralized piping.

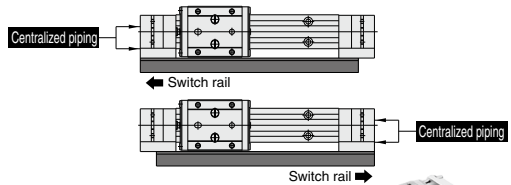

Adjuster

The stroke adjuster does not protrude from the mounting surface of the workpiece mounting surface, allowing high flexibility in workpiece mounting.

Workpiece mounting surface

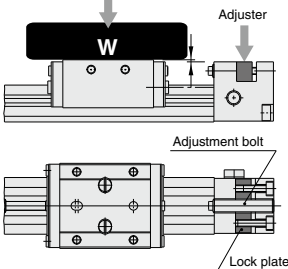

Using lock plates to securely lock the adjustment bolt with minimal force.

MXP Series

Compact air slide table that comes with linear guide with built-in cylinder.

Series	Stroke (mm)					Adjusters			Auto switch	
	5	10	15	20	25	30	Rubber stopper	Metal stopper	Shock absorber	
MXP 6	●	●	●	●	●	●	●	●	●	●
MXP 8	●	●	●	●	●	●	●	●	●	●
MXP10	●	●	●	●	●	●	●	●	●	●
MXP12	●	●	●	●	●	●	●	●	●	●
MXP16	●	●	●	●	●	●	●	●	●	●

Model Selection 1

The following are the steps for selection of the MXY series best suited to your application,

Conditions and Calculation Flow for Selection

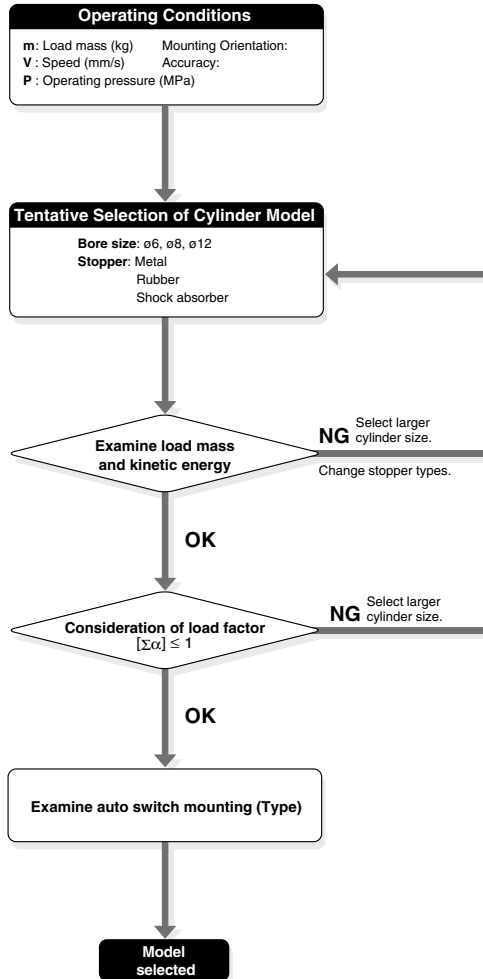

MX_Y Series

Model Selection 2

Model Selection Step	Formula/Data	Selection Example
<p>1 Operating Conditions</p> <p>Enumerate the operating conditions considering the mounting position and workpiece configuration.</p>	<ul style="list-style-type: none"> • Model to be used • Type of cushion • Mounting orientation • Average operating speed V_a (mm/s) • Load mass W (kg) • Overhang L_n (mm) 	<p>Cylinder: MX_Y8-100 Cushion: Rubber stopper Mounting: Horizontal wall mounting Average operating speed $V_a = 300$ [mm/s] Load mass: $W = 0.2$ [kg] $L_2 = 40$ mm $L_3 = 50$ mm</p> 
<p>2 Load Mass</p> <p>Find the collision speed V (mm/S)</p> <p>Confirm that the load mass W (kg) does not exceed the value in the graph.</p>	<p>$V = 1.4 \cdot V_a$ * Correction factor (Reference value)</p> <p>Graph (1)</p>	<p>$V = 1.4 \times 300 = 420$</p> <p>Confirm that $V = 420$ and $W = 0.2$ do not exceed the values in Graph (1).</p> <p>Applicable because it does not exceed the value in Graph (1).</p> 
<p>3 Load Factor</p>		
<p>3-1 Load Factor of Static Moment</p> <p>Find the static moment M (N-m).</p> <p>Find the allowable static moment M_a (N-m).</p> <p>Find the load factor α_1 of the static moment.</p>	<p>$M = W \times 9.8 (L_n + A_n)/1000$ Corrected value of moment center position distance A_n: Table (1)</p> <p>Pitch, Yaw moment: Graph (2)</p> <p>Roll moment: Graph (3)</p> <p>$\alpha_1 = M/M_a$</p>	<p>Examine M_r.</p> <p>$M_r = 0.2 \times 9.8 (40 + 15.5)/1000 = 0.1$ $A_2 = 15.5$</p> <p>Obtain $M_{ar} = 13$ from $V_a = 300$ in Graph (3).</p> <p>$\alpha_1 = 0.1/13 = 0.008$</p> 
<p>3-2 Load Factor of Dynamic Moment</p> <p>Find the dynamic moment M_e (N-m).</p> <p>Find the allowable dynamic moment M_{ea} (N-m).</p> <p>Find the load factor α_2 of the dynamic moment.</p>	<p>$M_e = 1/3 \cdot W_e \times 9.8 (L_n + A_n)/1000$ Mass equivalent to impact $W_e = \delta \cdot W \cdot V$ δ: Bumper coefficient Rubber stopper screw: 4/100 Shock absorber: 1/100 Metal stopper screw: 16/100 Corrected value of moment center position distance A_n: Table (1)</p> <p>Pitch, yaw moment: Graph (2)</p> <p>$\alpha_2 = M_e/M_{ea}$</p>	<p>Examine M_{ep}.</p> <p>$M_{ep} = 1/3 \times 3.36 \times 9.8 \times (40+15.5)/1000 = 0.61$ $W_e = 4/100 \times 0.2 \times 420 = 3.36$ $A^2 = 15.5$</p> <p>Obtain $M_{eap} = 4.2$ from $V = 420$ in Graph (2).</p> <p>$\alpha_2 = 0.61/4.2 = 0.15$</p>  <p>Examine M_{ey}.</p> <p>$M_{ey} = 1/3 \times 3.36 \times 9.8 \times (50+19)/1000 = 0.76$ $W_e = 3.36$ $A^3 = 19$</p> <p>Obtain $M_{eay} = 4.2$ from $V = 420$ in Graph (2).</p> <p>$\alpha_2' = 0.76/4.2 = 0.18$</p> 
<p>3-3 Sum of the Load Factors</p> <p>Use is possible if the sum of the load factors does not exceed 1.</p>	<p>$\alpha_1 + \alpha_2 < 1$</p>	<p>$\alpha_1 + \alpha_2 + \alpha_2' =$ Applicable because $0.008 + 0.15 + 0.18 = 0.34 < 1$</p>

Fig. (1) Overhang: Ln (mm), Correction Value of Moment Center Position Distance: An (mm)



Note) Static moment: Moment generated by gravity
Dynamic moment: Moment generated by impact when colliding with stopper

Graph (2) Allowable Moment
Pitch Moment: $M_{p\alpha}$, M_{ep}
Yaw Moment: $M_{y\alpha}$, M_{ey}

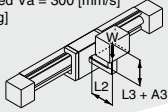
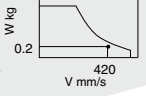
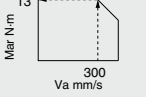
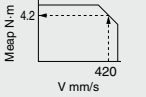
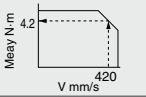
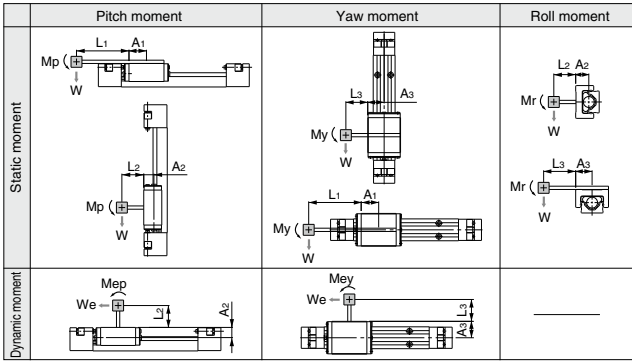
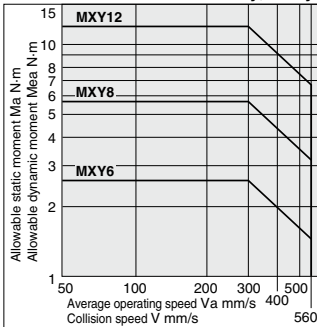

Note) Use the average operating speed when calculating static moment.
Use the collision speed when calculating dynamic moment.

Graph (3) Allowable Moment
Roll Moment: $M_{r\alpha}$

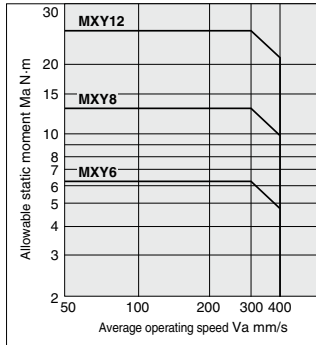

Table (1) Correction Value of Moment Center Position Distance: An (mm)

Model	Corrected value of moment center position distance (Refer to Figure 2.)		
	A ₁	A ₂	A ₃
MX _Y 6	16	14	15
MX _Y 8	20	15.5	19
MX _Y 12	26	23.5	25

Table (3) Maximum Allowable Moment: Mmax (N·m)

Model	Pitch/Yaw moment: $M_{p\alpha}/M_{y\alpha}$	Roll moment: $M_{r\alpha}$
MX _Y 6	2.6	6.2
MX _Y 8	5.7	13
MX _Y 12	12	28

The above value represents the maximum value of allowable moment. For the maximum allowable moment for each piston speed, please refer to Graph (2) and (3).

Symbol

Symbol	Definition	Unit	Symbol	Definition	Unit
An (n = 1 to 3)	Corrected value of moment center position distance	mm	F	Allowable static load	N
Ln (n = 1 to 3)	Overhang	mm	V	Collision speed	mm/s
M (Mp, My, Mr)	Static moment (pitch, yaw, roll)	N·m	Va	Average operating speed	mm/s
Ma (Map, May, Mar)	Allowable static moment (pitch, yaw, roll)	N·m	W	Load mass	kg
Me (Mep, Mey)	Dynamic moment (pitch, yaw)	N·m	Wa	Equivalent mass for impact	kg
Mea (Meap, Meay)	Allowable dynamic moment (pitch, yaw)	N·m	Wmax	Max. allowable load mass	kg
Mmax (Mpxmax, Mpymax, Mrmax)	Max. allowable moment (pitch, yaw, roll)	N·m	α	Load factor	—

Fig. (2) Allowable Static Load: F(N)

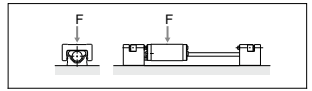

Graph (1) Load Mass: W

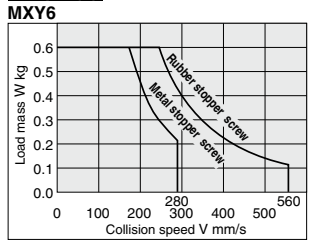

MX_Y8

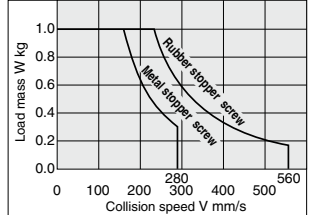

MX_Y12

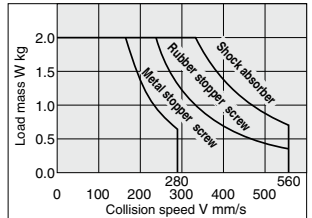

Table (2) Max. Allowable Load Mass: Wmax (kg)

Model	Max. allowable load weight
MX _Y 6	0.6
MX _Y 8	1
MX _Y 12	2

The above value represents the maximum value for each allowable load mass. For the maximum allowable load mass for each piston speed, please refer to Graph (1).

Table (4) Allowable Static Load: F (N)

Model	Allowable static load
MX _Y 6	580
MX _Y 8	980
MX _Y 12	1600

The above value represents the applicable load at the position where the moment does not work at the time of stop. Factors such as impact, etc. are not in consideration with the value.

Air Slide Table Long Stroke Type MXY Series

ø6, ø8, ø12



How to Order

MXY 6 - 50 - - - M9BW - - -

Bore size/Standard stroke (mm)

6	50, 100, 150, 200
8	50, 100, 150, 200, 250, 300
12	50, 100, 150, 200, 250, 300, 350, 400

Adjuster option

Nil	Rubber stopper
B*	Shock absorber
C	Metal stopper

* Only for MXY12

Mode to Order
For details, refer to page 479.

Number of auto switches

Nil	2 pcs.
S	1 pc.
n	"n" pcs.

Auto switch type

Nil	Without auto switch
-----	---------------------

One side centralized piping, switch rail

Nil	One side centralized piping, with switch rail
N	Without one side centralized piping, without switch rail

The auto switch cannot be mounted on the one side centralized piping type without switch rail (N).

Applicable Auto Switches

Refer to pages 1289 to 1383 for further information on auto switches.

Type	Special function	Electrical entry	Indicator	Wiring (Output)	Load voltage		Auto switch model		Lead wire length (m)				Pre-wired connector	Applicable load					
					DC	AC	Perpendicular	In-line	0.5 (Nil)	1 (M)	3 (L)	5 (Z)							
Solid state auto switch	—	Grommet	Yes	3-wire (NPN)	24 V	5 V, 12 V	—	M9NV	M9N	●	●	○	○	IC circuit	Relay, PLC				
				3-wire (PNP)				M9PV	M9P	●	●	○	○						
				2-wire				M9BV	M9B	●	●	○	○						
				3-wire (NPN)				M9NVW	M9NW	●	●	○	○						
	Diagnostic indication (2-color indicator)			Grommet	Yes	3-wire (PNP)	24 V	5 V, 12 V	—	—	M9PW	M9PW	●	●		○	○	IC circuit	
											2-wire	M9BWV	M9BW	●		●	○		○
											3-wire (NPN)	M9NAV ^{*1}	M9NA ^{*1}	○		○	○		○
											3-wire (PNP)	M9BAV ^{*1}	M9BA ^{*1}	○		○	○		○
Water resistant (2-color indicator)	Grommet	Yes	2-wire	24 V	12 V	—	—	A96V	A96	●	—	—	—	IC circuit					
								A93V ^{*2}	A93	●	●	●	—		—				
Read auto switch	—	Grommet	None	2-wire	24 V	12 V	—	—	A90V	A90	●	—	—	—	IC circuit				
									100 V	100 V or less	●	●	●	—		—			

*1 Water resistant type auto switches can be mounted on the above models, but in such case SMC cannot guarantee water resistance.
 *2 1 m type lead wire is only applicable to D-A93.
 * Lead wire length symbols: 0.5 m..... Nil (Example) M9NW * Solid state auto switches marked with "○" are produced upon receipt of order.
 1 m..... M (Example) M9NWM
 3 m..... L (Example) M9NWL
 5 m..... Z (Example) M9NWL
 * Refer to page 485 for applicable auto switches in addition to those listed above.
 * For details on auto switches with a pre-wired connector, refer to pages 1358 and 1359.
 * Auto switches are shipped together (not assembled).



Specifications



Symbol

Rubber bumper
(Magnet type)



Model		MXY6	MXY8	MXY12
Bore size (mm)		6	8	12
Port size		M5 x 0.8		
Fluid		Air		
Action		Double acting (type)		
Operating pressure		0.2 to 0.55 MPa		
Proof pressure		0.83 MPa		
Ambient and fluid temperature		-10 to 60°C		
Operating speed range (Average operating speed) ^{Note 1)}		50 to 400 mm/s ^{Note 2)} Metal stopper: 50 to 200 mm/s		
Cushion		Rubber bumper Shock absorber ^{Note 3)} (option, not available on MXY6, MXY8) None (with metal stopper)		
Lubrication		Non-lube (equipment), unlubricated		
Stroke adjustment range	Rubber stopper	One side 0 to 5 mm		
	Shock absorber	—	—	One side 0 to 15 mm
	Metal stopper	One side 0 to 5 mm		
Auto switch		Reed auto switches (2-wire, 3-wire) Solid state auto switches (2-wire, 3-wire) 2-color indicator solid state auto switches (2-wire, 3-wire)		
Stroke length tolerance		+ $\frac{1}{0}$ mm		

Note 1) Average operating speed: Speed that the stroke is divided by a period of time from starting the operation to reaching the end.

Note 2) When the smooth operation is required in a low speed range of 80 mm/s or less, contact SMC.

Note 3) The shock absorber service life is different from that of the MXY cylinder depending on operating conditions. Refer to the Specific Product Precautions for the replacement period.

Theoretical Output

(N)

Cylinder bore (mm)	Piston area (mm ²)	Operating pressure (MPa)				
		0.2	0.3	0.4	0.5	0.55
6	28	6	8	11	14	15
8	50	10	15	20	25	28
12	113	23	34	45	57	62



Made to Order: Individual Specifications

(Refer to pages 486 and 487 for details.)

Symbol	Specifications
-X7	PTFE grease
-X9	Grease for food processing machines
-X11	Adjusting bolt, long specification (Adjustment range: 15 mm)
-X12	Adjusting bolt, long specification (Adjustment range: 25 mm)
-X39	Fluororubber seal
-X42	Anti-corrosive guide unit

Standard Stroke

(mm)

Model	Standard stroke
MXY6	50, 100, 150, 200
MXY8	50, 100, 150, 200, 250, 300
MXY12	50, 100, 150, 200, 250, 300, 350, 400

Magnetic

Holding Force

(N)

Model	Magnetic holding force
MXY6	19
MXY8	34
MXY12	77

Weight

(g)

Model	One side centralized piping, with switch rail								One side centralized piping, without switch rail								Additional weight of option Shock absorber
	Stroke (mm)								Stroke (mm)								
	50	100	150	200	250	300	350	400	50	100	150	200	250	300	350	400	
MXY6	270	330	390	450	—	—	—	—	230	280	330	380	—	—	—	—	—
MXY8	420	510	600	690	780	870	—	—	410	480	550	620	690	760	—	—	—
MXY12	930	1060	1190	1320	1450	1580	1710	1840	910	1020	1130	1240	1350	1460	1570	1680	15

Moisture Control Tube IDK Series



When operating an actuator with a small diameter and a short stroke at a high frequency, the dew condensation (water droplet) may occur inside the piping depending on the conditions.

Simply connecting the moisture control tube to the actuator will prevent dew condensation from occurring. For details, refer to the [Web Catalog](#).

The graphs below show the table displacement when the static moment load is applied to the table. The graphs do not show the loadable mass. Refer to the Model Selection for the loadable mass.

Table Deflection (Reference Values)

Table deflection due to pitch moment load

Displacement at "A" when load is applied "F"

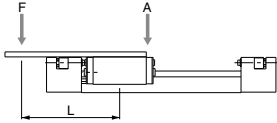

L dimension	mm
MX Y6	100
MX Y8	100
MX Y12	140

Pitch moment

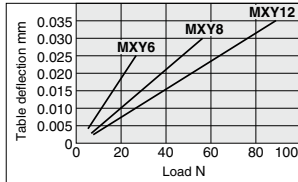
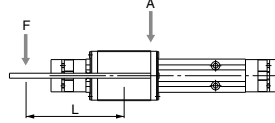

Table deflection due to yaw moment load

Displacement at "A" when load is applied "F"



L dimension	mm
MX Y6	100
MX Y8	100
MX Y12	140

Yaw moment

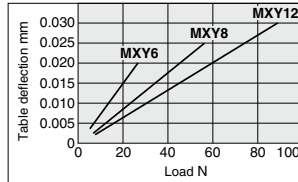
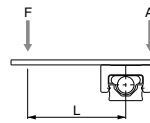

Table deflection due to roll moment load

Displacement at "A" when load is applied "F"



L dimension	mm
MX Y6	100
MX Y8	100
MX Y12	140

Roll moment

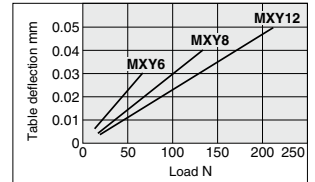

Construction

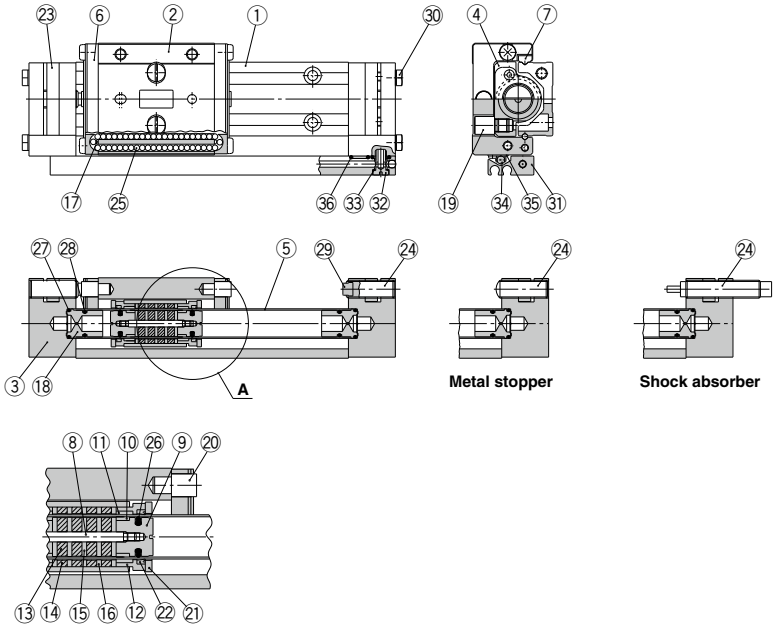

Detail drawing of part A

Component Parts

No.	Description	Material	Note
1	Rail	Hardening steel	Heat treatment, electroless nickel plated
2	Guide block	Hardening steel	Heat treatment, electroless nickel plated
3	End plate	Aluminum alloy	Hard anodized
4	Body	Aluminum alloy	Hard anodized
5	Tube	Stainless steel	
6	Cover	Resin	
7	Scraper	Stainless steel, NBR	
8	Shaft	Stainless steel	
9	Piston	Brass	Electroless nickel plated
10	Wear ring A	Resin	
11	Wear ring B	Resin	
12	Spacer	Brass	Electroless nickel plated
13	Magnet A	—	Nickel plated
14	Magnet B	—	Nickel plated
15	Yoke A	Steel	Electroless nickel plated
16	Yoke B	Steel	Electroless nickel plated
17	Return guide	Resin	
18	End cap	Resin	
19	Stud	Stainless steel	Heat treatment

No.	Description	Material	Note
20	Stopper screw	Stainless steel	Heat treatment
21	External magnet fix plate	Stainless steel	
22	Cylinder scraper	NBR	
23	Lock plate	Stainless steel	
24	Adjustment bolt	Steel	Zinc chromated Rubber stopper
		Stainless steel	Metal stopper
	Shock absorber	—	Shock absorber
25	Steel ball	High carbon chrome bearing steel	
26	Piston seal	NBR	
27	O-ring	NBR	
28	O-ring	NBR	
29	Adjustment bumper	Polyurethane	Rubber stopper
30	Plug	Carbon steel	Nickel plated
31	Switch rail	Aluminum alloy	Hard anodized
32	Stud	Brass	Electroless nickel plated
33	Gasket	NBR	
34	Magnet	—	
35	Magnet holder	Steel	Electroless nickel plated
36	O-ring	NBR	

Replacement Parts

Bore size (mm)	Kit no.	Contents
6	MX _Y 6-PS	A set of two of ⑩, ⑪, ⑫ and ⑬ each * There is only 1 pc. of ⑬ for the MX _Y 12-PS.
8	MX _Y 8-PS	
12	MX _Y 12-PS	

Replacement Parts: Grease Pack

Grease pack part no.
GR-S-010 (10g)
GR-S-020 (20g)

MXY Series

Dimensions

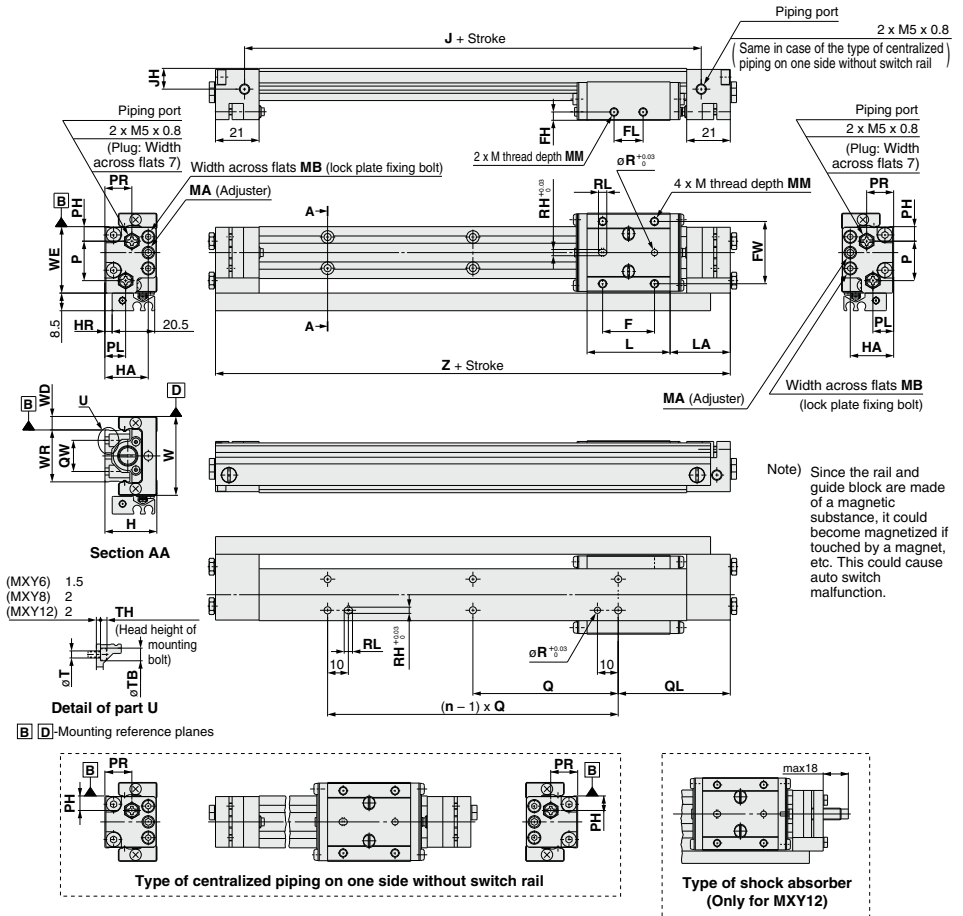

Model	F	FH	FL	FW	H	HA	HR	J	JH	L	LA	M	MM	MA	MB
MXY6	20	3	12	24	21.5	18	0.5	60	8.5	32	28	M3 x 0.5	4	M5 x 0.8 (Width across flats 2.5)	2
MXY8	25	4	14	30	25	20.9	3.5	70	10	40	29	M4 x 0.7	5	M6 x 1 (Width across flats 3)	2.5
MXY12	32	5	18	40	36	30.9	8.5	86	15	52	31	M5 x 0.8	6	M8 x 1 (Width across flats 4)	3

Model	P	PH	PL	PR	Q	QW	R	RH	RL	T	TB	TH	W	WD	WE	WR	Z
MXY6	13	7	9	11	60	12	3 (depth 3)	3 (depth 3)	4	2.9	5.1	2.5	30	5	25.5	20	88
MXY8	19	7	10	13	70	15	3 (depth 3)	3 (depth 3)	4	3.4	6.1	3	38	6.5	32	25	98
MXY12	29	7	13	18	90	21	4 (depth 4)	4 (depth 4)	5	4.5	7.8	4	50	8.5	42	33	114

Model	n								QL							
	50	100	150	200	250	300	350	400	50	100	150	200	250	300	350	400
Stroke	50	100	150	200	250	300	350	400	50	100	150	200	250	300	350	400
MXY6	2	3	3	4	—	—	—	—	39	34	59	54	—	—	—	—
MXY8	2	2	3	4	5	5	—	—	39	64	54	44	34	59	—	—
MXY12	2	2	3	3	4	4	5	5	37	62	42	67	47	72	52	77

Dimensions of Adjusting Bolt/Rubber Stopper

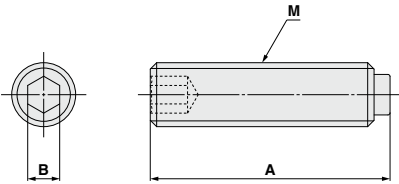

Applicable size	Model	Stroke adjustment range mm	A	B	M
MX _Y 6	MX _Y -A627	5	22.5	2.5	M5×0.8
	MX _Y -A627-X11	15	32.5		
	MX _Y -A627-X12	25	42.5		
MX _Y 8	MX _Y -A827	5	22.5	3	M6×1
	MX _Y -A827-X11	15	32.5		
	MX _Y -A827-X12	25	42.5		
MX _Y 12	MX _Y -A1227	5	23	4	M8×1
	MX _Y -A1227-X11	15	33		
	MX _Y -A1227-X12	25	43		

How to Order Adjusting Bolt/Rubber Stopper

MX_Y — A 12 27 — X11

Applicable bore size ●

MX _Y 6	ø6
MX _Y 8	ø8
MX _Y 12	ø12

● Adjustment range

Nil	5 mm
-X11	15 mm
-X12	25 mm

* For dimensions, refer to the figure above.

MX Y Series

Dimensions of Adjusting Bolt/Metal Stopper

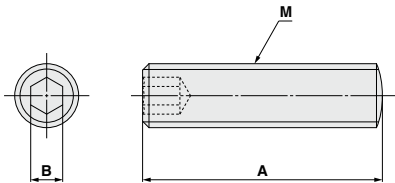

Applicable size	Model	Stroke adjustment range mm	A	B	M
MX Y6	MX Y-A638	5	22.5	2.5	M5×0.8
	MX Y-A638-X11	15	32.5		
	MX Y-A638-X12	25	42.5		
MX Y8	MX Y-A838	5	22.5	3	M6×1
	MX Y-A838-X11	15	32.5		
	MX Y-A838-X12	25	42.5		
MX Y12	MX Y-A1238	5	23	4	M8×1
	MX Y-A1238-X11	15	33		
	MX Y-A1238-X12	25	43		

How to Order Adjusting Bolt/Metal Stopper

MX Y — A 12 38 — X11

Applicable bore size ●

MX Y6	ø6
MX Y8	ø8
MX Y12	ø12

● Adjustment range

Nil	5 mm
-X11	15 mm
-X12	25 mm

* For dimensions, refer to the figure above.

Auto Switch Mounting

Auto Switch Proper Mounting Position (Detection at Stroke End)

Reed Auto Switch

D-A90(V), D-A93(V), D-A96(V) (mm)

Model	Mounting	Auto switch operating range
MX _Y 6	A	54
	B	34
MX _Y 8	A	59
	B	39
MX _Y 12	A	67
	B	47

Lead wire entries outside

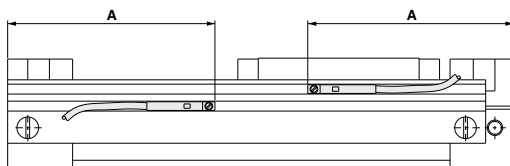

Solid State Auto Switch

D-M9B(V), D-M9N(V), D-M9P(V) (mm)

Model	Mounting	Auto switch operating range
MX _Y 6	A	50
	B	38
MX _Y 8	A	55
	B	43
MX _Y 12	A	63
	B	51

Lead wire entries inside

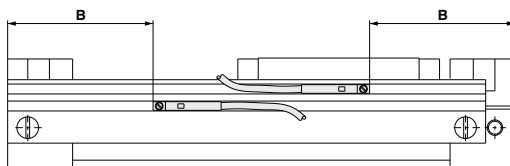

2-Color Indicator Solid State Auto Switch

D-M9BW(V), D-M9N(V), D-M9PW, D-M9□A(V) (mm)

Model	Mounting	Auto switch operating range
MX _Y 6	A	50
	B	38
MX _Y 8	A	55
	B	43
MX _Y 12	A	63
	B	51

Lead wire entries parallel

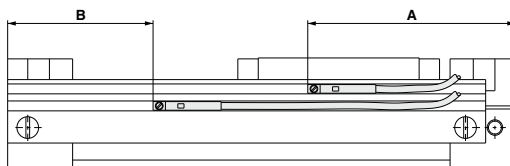

* Adjust the auto switch after confirming the operating conditions in the actual setting.

Auto Switch Mounting

⚠ Caution

Auto Switch Mounting Tool

- When tightening the auto switch mounting screw (included with auto switch), use a watchmaker's screwdriver with a handle diameter of about 5 to 6 mm.

Tightening Torque

Tightening Torque of Auto Switch Mounting Screw (N·m)

Auto switch model	Tightening torque
D-A9□(V)	0.10 to 0.20
D-M9□(V)	0.05 to 0.15
D-M9□W(V)	
D-M9□A(V)	0.05 to 0.10

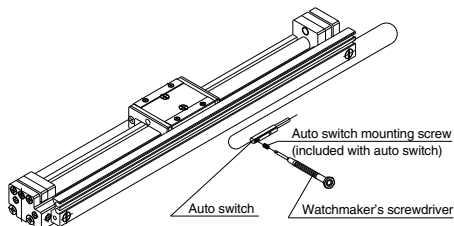

Other than the applicable auto switches listed in "How to Order", the following auto switches can be mounted.

* Normally closed (NC = b contact) solid state auto switches (D-M9□E(V)) and a solid state auto switch (D-F8) are also available. Refer to pages 1307 and 1308 for details.

MXY Series

Made to Order: Individual Specifications 1

Please contact SMC for detailed dimensions, specifications and lead times.



1 PTFE Grease Symbol -X7

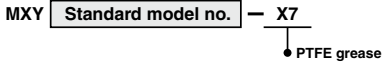

PTFE grease is used for all parts that grease is applied.

* For the type with a shock absorber, standard grease is used on the shock absorber part.

Specifications

Type	PTFE grease
Bore size (mm)	6, 8, 12

* Dimensions other than the above is the same as the standard type.

Warning Precautions

Be aware that smoking cigarettes, etc. after your hands have come into contact with the grease used in this cylinder can create a gas that is hazardous to humans.

2 Grease for Food Processing Machines Symbol -X9

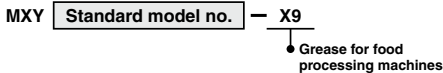

Grease for food processing machines is used for all parts that grease is applied.

* For the type with a shock absorber, standard grease is used on the shock absorber part.

Specifications

Type	Grease for Food Processing Machines (NSF-H1 certified)/Aluminum Complex Soap Base Grease
Bore size (mm)	6, 8, 12

* Dimensions other than the above is the same as the standard type.

Caution

- Do not use in a food contact environment.
- Do not use in a liquid splash environment, e.g. water, detergent, liquid chemicals.

<Not installable>

Food zone

An environment where food which will be sold as merchandise directly touches the cylinder's components

Splash zone

An environment where food which will not be sold as merchandise directly touches the cylinder's components

<Installable>

Non-food zone

An environment where there is no contact with food

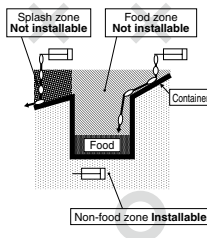

3 Fluororubber Seal Symbol -X39

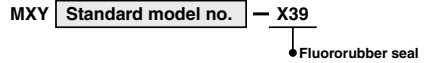

Change the materials for the piston seal, cylinder scraper, O-rings and scrapers (rubber lined parts) to fluororubber.

Specifications

Type	Fluororubber seal
Bore size (mm)	6, 8, 12
Seal material	Fluororubber

* Dimensions other than the above is the same as the standard type.

4 Anti-corrosive Specifications for Guide Unit Symbol -X42

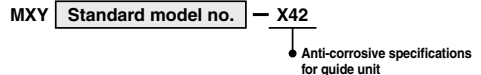

Anti-corrosive treatment is applied to the rail and guide block.

Specifications

Type	Anti-corrosive guide unit
Bore size (mm)	6, 8, 12
Surface treatment	Special anti-corrosive treatment ⁽²⁾

* 1 Dimensions other than the above is the same as the standard type.

* 2 The special anti-corrosive treatment turns rail and guide block black.

MXY Series

Made to Order: Individual Specifications 2

Please contact SMC for detailed dimensions, specifications and lead times.



5 Adjustment Bolt, Long Specification (Adjustment range: 15 mm) **-X11**

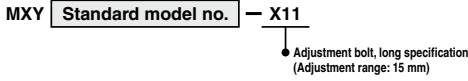

* -X11 is not available for those with a shock absorber.
The average adjusting stroke range was extended from 5 mm to 15 mm with a long adjustment bolt.

Dimensions

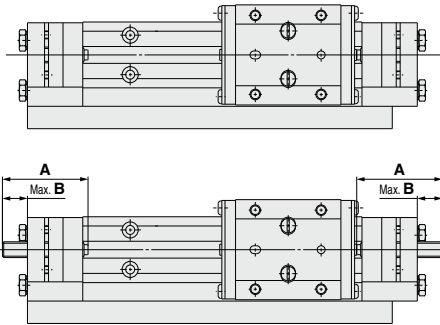

Rubber Stopper (mm)

Model	A	B
MXY6	32.5	10
MXY8	32.5	10
MXY12	33	10

Metal Stopper (mm)

Model	A	B
MXY6	32.5	10
MXY8	32.5	10
MXY12	33	10

6 Adjustment Bolt, Long Specification (Adjustment range: 25 mm) **-X12**

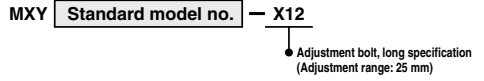

* -X12 is not available for those with a shock absorber.
The average adjusting stroke range was extended from 5 mm to 25 mm with a long adjustment bolt.

Dimensions

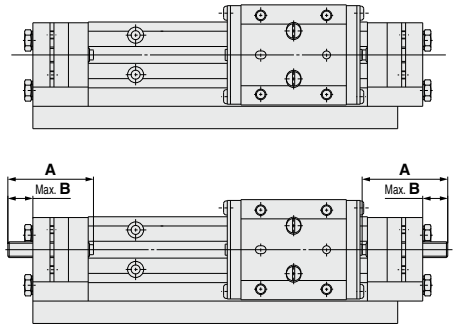

Rubber Stopper (mm)

Model	A	B
MXY6	42.5	20
MXY8	42.5	20
MXY12	43	20

Metal Stopper (mm)

Model	A	B
MXY6	42.5	20
MXY8	42.5	20
MXY12	43	20



MX_Y Series

Specific Product Precautions 1

Be sure to read this before handling the products.

Refer to page 8 for safety instructions and pages 9 to 18 for actuator and auto switch precautions.

Selection

⚠ Caution

1. Use a load within a range that does not exceed the operating limit.

Select models based on the maximum load weight and the allowable moment. Refer to model selection on pages 475 to 477 for detailed methods. If operated beyond the operating limit, the eccentric load applied to the guide section will be excessive. This can have an adverse effect on service life due to vibration in the guide unit and loss of accuracy, etc.

2. When performing intermediate stops with an external stopper, employ measures to prevent lurching.

If lurching occurs damage can result. When making a stop with an external stopper to be followed by continued forward movement, first supply pressure to momentarily reverse the table, then retract the intermediate stopper, and finally apply pressure to the opposite port to operate the table again.

3. In vertical operation, it is not possible to stop the piston at an intermediate position using a closed center solenoid valve, etc.

In vertical operation, it is not possible to stop the piston at an intermediate position using a closed center solenoid valve because it can cause dislocation of the magnet coupling. The only available option in such cases is use of an external stopper for an intermediate stop.

4. When stopping the piston using a closed center solenoid valve in horizontal operation, do not allow the kinetic energy exceed the allowable kinetic energy.

When stopping the piston using a closed center solenoid valve in horizontal operation, do not allow the kinetic energy of the load to exceed the values shown below. If the allowable value is exceeded, it can cause dislocation of the magnet coupling.

Model	Allowable kinetic energy for intermediate stop (J)
MX _Y 6	0.007
MX _Y 8	0.014
MX _Y 12	0.047

5. Do not operate in such a way that excessive external forces or impact forces are applied to the product.
This can cause damage.

6. Be careful in an application which requires precision in the middle of a stroke.

If straightness is required in the middle of a stroke, fix the entire rail mounting surface on the base.

Mounting

⚠ Caution

1. Do not scratch or gouge the mounting surfaces of the body, table and end plate.

This can cause loss of parallelism in the mounting surfaces, vibration in the guide unit and increased operating resistance, etc.

2. Do not scratch or gouge the transfer surfaces of the rail and guide.

This can cause vibration and increased operating resistance, etc.

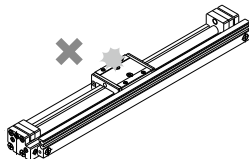

3. Do not apply strong impacts or excessive moment when mounting workpieces.

Application of external forces greater than the allowable moment can cause vibration in the guide unit and increased operating resistance, etc.

4. Ensure that the parallelism of the mounting surface is 0.02 mm or less.

Poor parallelism of the workpiece mounted on the body, the base, and other parts can cause vibration of the guide unit and increased operating resistance, etc.

Mounting

⚠ Caution

5. For connection to a load that has an external support or guide mechanism, select an appropriate connection method and perform careful alignment.

6. Keep away objects which can be influenced by magnets.

A magnet is built inside the body or, in case of a type with auto switch, on the side of the guide lock. Please keep away magnetic disks, cards or tapes. Otherwise, the data can be deleted.

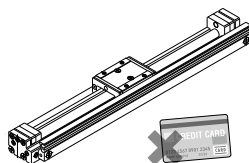

7. Do not attach magnets to the rail and guide block.

Since the body and table (guide block) are made of a magnetic substance, it could become magnetized if touched by a magnet, etc. This could cause auto switch malfunction.



MX_Y Series

Specific Product Precautions 2

Be sure to read this before handling the products.

Refer to page 8 for safety instructions and pages 9 to 18 for actuator and auto switch precautions.

Mounting

⚠ Caution

8. When mounting the body, use screws of an appropriate length and do not exceed the maximum tightening torque.

Tightening with a torque above the limit could cause malfunction. Whereas tightening insufficiently could result in misalignment or dropping.

Using through holes

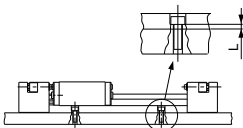

Model	Bolt	Max. tightening torque N·m	Rail thickness L (mm)
MX _Y 6	M2.5 x 0.45	0.65	1.5
MX _Y 8	M3 x 0.5	1.14	2
MX _Y 12	M4 x 0.7	2.7	2

Top mounting type

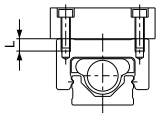

Model	Bolt	Max. tightening torque N·m	Max. screw-in depth L (mm)
MX _Y 6	M3 x 0.5	1.14	3
MX _Y 8	M4 x 0.7	2.7	4
MX _Y 12	M5 x 0.8	5.4	5

Side mounting type

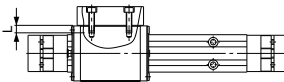

Model	Bolt	Max. tightening torque N·m	Max. screw-in depth L (mm)
MX _Y 6	M3 x 0.5	1.14	3
MX _Y 8	M4 x 0.7	2.7	4
MX _Y 12	M5 x 0.8	5.4	5

9. Be careful not to bruise the outer surface of the cylinder tube.

If can damage the scraper and wear ring and result in malfunction.

10. Make sure that the magnet coupling is in position when operating.

In case it is displaced, please return it to the right position by pushing the external mover by hand (or pushing the piston mover with air pressure).

11. In vertical operation, be careful about dislocation of the magnet coupling.

Note that the mover may drop off due to dislocation of the magnet coupling if pressure or load beyond the specification is applied.

12. The positioning holes on the top surface of the guide block and those on the bottom of the rail are not aligned.

These holes are used when re-mounting the same product after having removed it for maintenance.

Operating Environment

⚠ Caution

1. Do not use in environments where there is direct exposure to liquids such as cutting oil.

Operation in environments where the body is exposed to cutting oil, coolant or oil mist can cause vibration, increased operating resistance and air leakage, etc.

2. Do not use in environments where there is direct exposure to foreign matter such as dust, dirt, chips and spatter.

This can cause vibration, increased operating resistance and air leakage, etc.

Do not use the product in the following conditions.

3. Provide shade in locations exposed to direct sunlight.

4. Block off sources of heat located near by.

When there are heat sources in the surrounding area, radiated heat may cause the product's temperature to rise and exceed the operating temperature range. Block off the heat with a cover, etc.

Operating Environment

⚠ Caution

5. Do not use in locations where vibration or impact occurs.

Do not use the product in such an environment as is can result in damage or malfunction.

6. Be careful about the corrosion resistance of the linear guide.

Rust may result especially in an environment that allows water drops from condensation to stay on the surface.

Handling of Adjuster Options

Stroke adjuster

⚠ Caution

1. Do not replace the special adjusting bolt with other bolts.

This may cause looseness and damage due to impact forces, etc.

2. Use the tightening torque in the table below for the lock nut.

Insufficient torque will cause a decrease in the positioning accuracy.

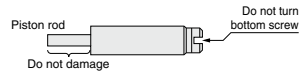

Service Life and Replacement Period of Shock Absorber

⚠ Caution

1. Allowable operating cycle under the specifications set in this catalog is shown below.

1.2 million cycles RB08□□

Note) Specified service life (suitable replacement period) is the value at room temperature (20 to 25°C). The period may vary depending on the temperature and other conditions. In some cases the absorber may need to be replaced before the allowable operating cycle above.

Applicable size	Shock absorber model
MX _Y 12	RB0806N



MX_Y Series

Specific Product Precautions 3

Be sure to read this before handling the products.

Refer to page 8 for safety instructions and pages 9 to 18 for actuator and auto switch precautions.

Stroke Adjustment

⚠ Caution

1. Adjustment method

Loosen the 2 lock plate fixing bolts (or shock absorbers) and rotate the adjustment bolt (or shock absorber) to adjust the stroke. Then tighten the lock plate fixing bolts evenly to secure the adjustment bolt (or shock absorber). Be careful not to tighten the lock plate adjusting bolts too firmly.

Model	Tightening torque of lock plate fixing bolt
MX _Y 6	0.1 N·m
MX _Y 8	0.2 N·m
MX _Y 12	0.4 N·m

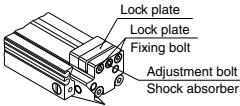

Note)

The lock plate may bend slightly due to tightening of the lock plate fixing bolts but it will not affect the adjustment bolt or shock absorber that has been secured.

2. Adjustment range

Adjust the stroke within the range where the stopper or shock absorber works effectively. As a guideline, keep the stroke within the range where the L dimension in the figure below is larger than the value in the table. If the stroke exceeds this range, the guide lock will bump into the end plate, affecting the life time.

Model	L
MX _Y 6	2 mm
MX _Y 8	2 mm
MX _Y 12	2.5 mm

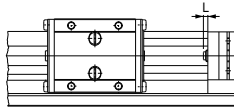

Rubber stopper screw

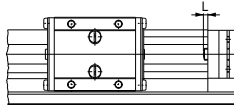

Metal stopper screw

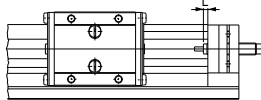

Shock absorber

Other

⚠ Warning

1. Do not put hands or fingers between the end plate and mover.

Never put hands or fingers in the gap between the end plate and mover when retracted. Doing so will result in injury to the hands, or fingers.

⚠ Caution

1. Do not disassemble or modify the product.

2. Performance stability

The piston speed in the specification table shows the average speed. The actual speed of this product may vary slightly during the stroke depending on the operating conditions, such as the change of load resistance and pressure.



MXV Series

Specific Product Precautions 4

Be sure to read this before handling the products.

Refer to page 8 for safety instructions and pages 9 to 18 for actuator and auto switch precautions.

How to Change Concentrated Piping

The piping is concentrated on the left side at the time of shipment. To switch to the right side piping, follow the steps below.

1. Loosen the 2 studs to remove the switch rail.

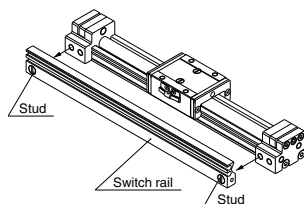

2. Change the position of the O-ring shown in the figure.

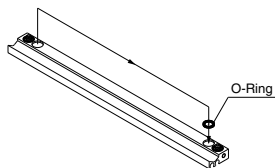

3. Fasten the stud onto the tap at the right side of the end plate and secure the switch rail.

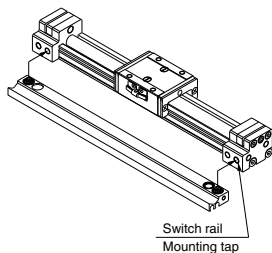

* Stud fastening: After a temporary tightening, tighten an additional 1/4 turn.

At the time of shipment

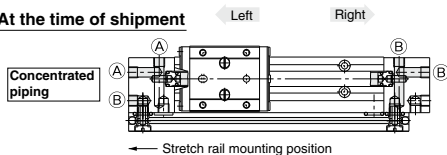

After change

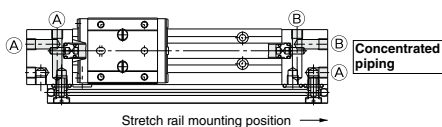

Port	Actuation Direction
(A)	Right
(B)	Left

Disassembly and Maintenance

Warning

Be careful the magnets have a large absorption force.

Please pay enough attention when the external mover and piston mover are removed from the cylinder tube for maintenance, etc. Because the magnet mounted on each mover has a large adsorption force. Please refer to the disassembly instructions when disassembling the product.

Caution

1. Be careful if the external mover is removed in the normal condition, it will directly absorb the piston mover.

When removing the external mover or piston mover, first force the magnet coupling to go off the position to disable the holding power and then remove them separately. If they are removed in the normal condition, the magnets will directly absorb each other and will not go apart.

2. Never disassemble the magnet constructions (piston mover and external mover).

If can cause a drop of the holding power or malfunction.