

Air Cylinder

MB Series

ø32, ø40, ø50, ø63, ø80, ø100, ø125

RoHS

Weight **10% lighter**
(ø40-100 stroke)

MB Series

Current model

0.91 kg <<< **1.01 kg**

Reduced weight by
changing the shape of
the rod cover and
head cover.

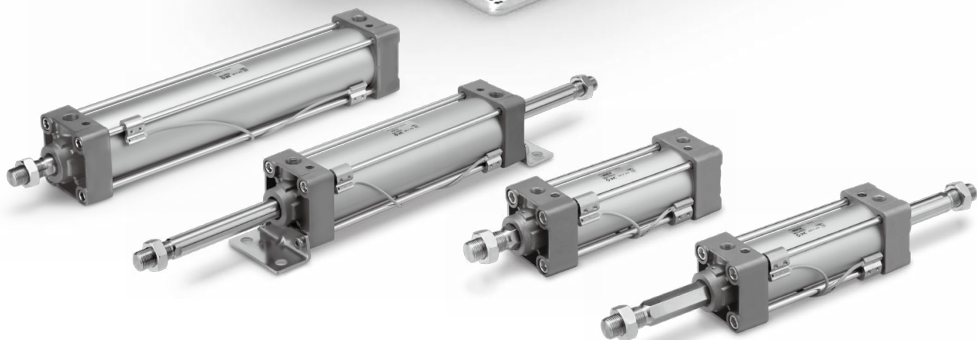
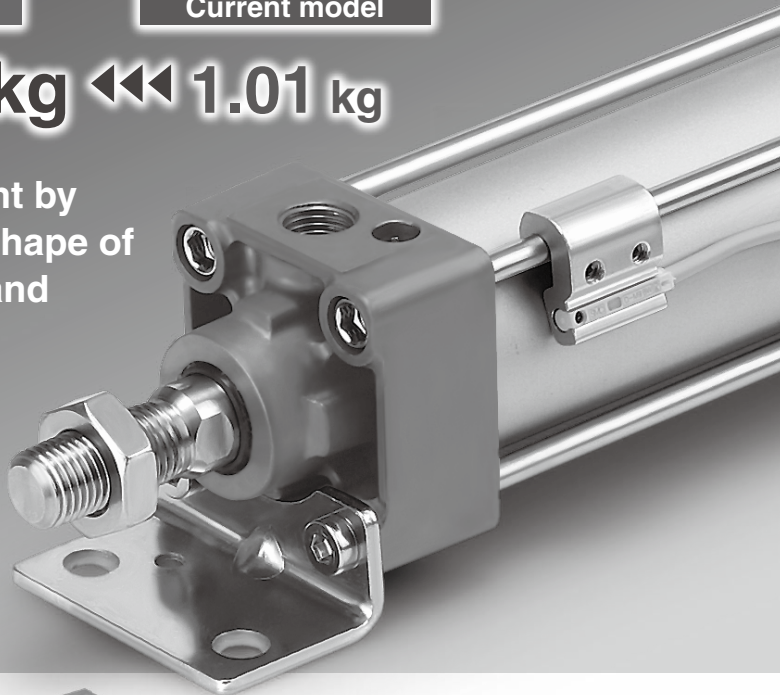

Part numbers with rod end bracket and/or pivot bracket available

Not necessary to order a bracket for the applicable cylinder separately

Note) Mounting bracket is shipped together with the product, but not assembled.

Example) **MDB**D**-40-100Z-****N****V****-M9BW**

● Mounting type

Pivot bracket

Nil	No bracket
N	Pivot bracket is shipped together with the product, but not assembled.

* Applicable to only D (Double clevis) and T (Center trunnion) mounting types.

Double clevis



Center trunnion



Rod end bracket

Nil	No bracket
V	Single knuckle joint
W	Double knuckle joint

With rod end bracket

V: Single knuckle joint **W:** Double knuckle joint



Various mounting bracket options

- Suitable mounting brackets can be selected for the installation condition.
- Improved amount of mounting freedom

N: Double clevis pivot bracket

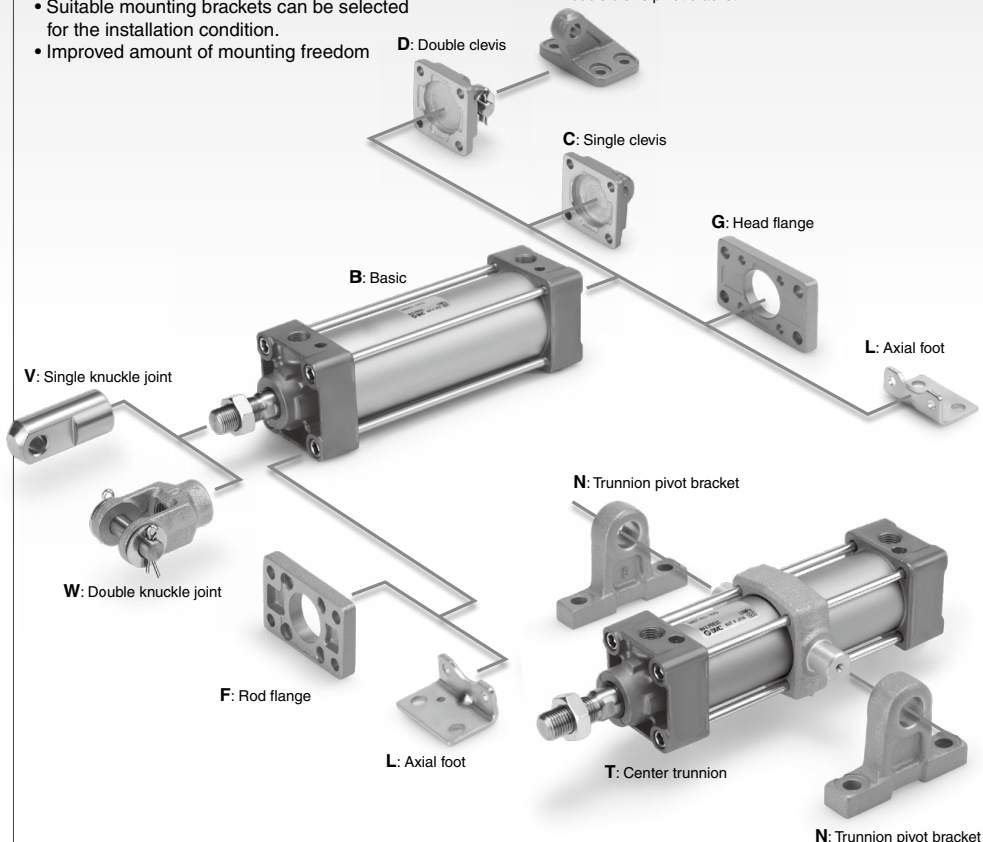

N: Trunnion pivot bracket

Lightweight

Reduced weight by changing the shape of the rod cover and head cover.

Bore size [mm]	MB	Reduction rate [%]	Current model [kg]
32	0.66	8	0.72
40	0.91	10	1.01
50	1.56	9	1.71
63	1.83	9	2.01
80	3.25	9	3.57
100	4.48	7	4.82
125	6.90	0	6.90

* At 100 stroke

Applicable speed/load

- Piston speed: Max. **1000** mm/s (ø32 to ø125)
- Load yield: See table below.
[kg]

Bore size [mm]	Maximum load mass [kg]
32	80
40	140
50	190
63	310
80	500
100	800
125	1300

* Speed: 200 mm/s

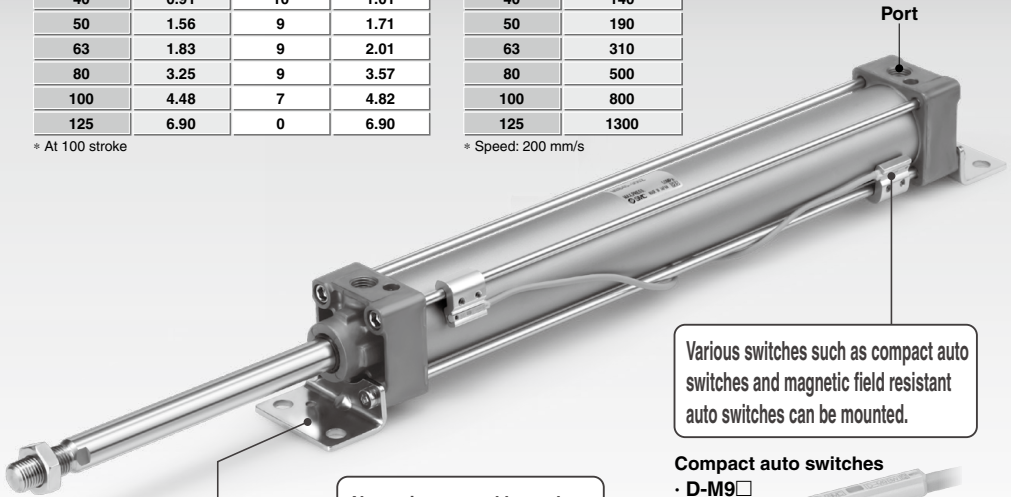

Mounting dimensions are the same as the current product.

No environmental hazardous substances used
Lead free bushing is used as sliding material. Compliant with EU RoHS directive.

Various switches such as compact auto switches and magnetic field resistant auto switches can be mounted.

Compact auto switches

- D-M9□
- D-A9□



Magnetic field resistant auto switches

- D-P3DWA
- D-P4DW



Series Variations

Series	Type	Cushion	Bore size [mm]							Built-in magnet rod boot	With rod boot	Page
			32	40	50	63	80	100	125			
Standard Single rod MB-Z	Double acting, Single rod	Rubber	●	●	●	●	●	●	●	●	●	482
		Air	●	●	●	●	●	●	●	●	●	
Standard Double rod MBW-Z	Double acting, Double rod	Rubber	●	●	●	●	●	●	●	●	●	492
		Air	●	●	●	●	●	●	●	●	●	
Non-rotating rod Single rod MBK-Z	Double acting, Single rod	Rubber	●	●	●	●	●	●	●	●	●	498
		Air	●	●	●	●	●	●	●	●	●	
Non-rotating rod Double rod MBKW-Z	Double acting, Double rod	Rubber	●	●	●	●	●	●	●	●	●	502
		Air	●	●	●	●	●	●	●	●	●	
With end lock MBB	Double acting, Single rod	Rubber	●	●	●	●	●	●	●	●	●	506
		Air	●	●	●	●	●	●	●	●	●	
Smooth Cylinder MBY-Z	Double acting, Single rod	Rubber	●	●	●	●	●	●	●	●	●	Web Catalog

Combinations of Standard and Made to Order Specifications

MB Series

- : Standard
- ⊙ : Made to Order
- : Special product
- : Not available

Series	MB-Z (Standard type)										
	Double acting										
	Single rod				Double rod						
	Air		Rubber		Air		Rubber				
Action/ Type											
Cushion Page	482				492						
Symbol	Specifications	Applicable bore size	ø32 to ø100	ø125	ø32 to ø100	ø125	ø32 to ø100	ø125	ø32 to ø100	ø125	
Standard	Standard	ø32 to ø125	●	●	●	●	●	●	●	●	
Long st	Long stroke		●	●	●	●	●	●	●	●	
D	Built-in magnet		●	●	●	●	●	●	●	●	
MB□-□k	With rod boot		●	●	●	●	●	●	●	●	
25A	Copper (Cu) and Zinc (Zn)-free <small>Note 1)</small>	ø32 to ø100	●	○	○	○	○	○	○		
MB□R	Water resistant	ø32 to ø125	●	○	●	○	●	○	●	○	
10-	Clean series <small>Note 6)</small>		○	○	○	○	○	○	○	○	
20-	Copper <small>Note 5)</small> and Fluorine-free <small>Note 6)</small>		— <small>Note 9)</small>	— <small>Note 9)</small>	— <small>Note 9)</small>	— <small>Note 9)</small>	— <small>Note 9)</small>	— <small>Note 9)</small>	— <small>Note 9)</small>	— <small>Note 9)</small>	
XA□	Change of rod end shape	ø32 to ø125	⊙	⊙	⊙	⊙	⊙	⊙	⊙	⊙	
XB5	Oversized rod cylinder <small>Note 6)</small>		⊙	○	○	○	○	○	○	○	
XB6	Heat resistant cylinder (-10 to 150°C)		⊙	⊙	○	○	⊙	○	○	○	
XB13	Low speed cylinder (5 to 50 mm/s)		⊙ <small>Note 10)</small>	○	⊙ <small>Note 10)</small>	○	○	○	○	○	
XC3	Special port location <small>Note 6)</small> <small>Note 7)</small>		⊙	○	⊙	○	⊙	○	⊙	○	
XC4	With heavy duty scraper		⊙	○	⊙	○	⊙	○	⊙	○	
XC5	Heat resistant cylinder (-10 to 110°C)		⊙	⊙	○	○	⊙	○	○	○	
XC6	Made of stainless steel		—	⊙	—	⊙	—	⊙	—	⊙	
XC7	Tie-rod, cushion valve, tie-rod nut, etc. made of stainless steel		⊙	○	⊙	○	⊙	○	⊙	○	
XC8	Adjustable stroke cylinder/Adjustable extension type		⊙	○	○	○	—	—	—	—	
XC9	Adjustable stroke cylinder/Adjustable retraction type		⊙	○	⊙	○	—	—	—	—	
XC10	Dual stroke cylinder/Double rod type		⊙	○	○	○	—	—	—	—	
XC11	Dual stroke cylinder/Single rod type		⊙	○	⊙	○	—	—	—	—	
XC12	Tandem cylinder		⊙	○	⊙	○	○	○	○	○	
XC14	Change of trunnion bracket mounting position		⊙	⊙	⊙	⊙	⊙	⊙	⊙	⊙	
XC22	Fluororubber seal		⊙	⊙	○	○	⊙	○	○	○	
XC26	With split pins for double clevis pin/double knuckle joint pin and flat washers		ø125	—	⊙	—	—	—	—	—	
XC27	Double clevis and double knuckle joint pins made of stainless steel		ø32 to ø125	⊙	⊙	⊙	⊙	—	—	—	—
XC29	Double knuckle joint with spring pin			⊙	○	⊙	○	○	○	○	○
XC30	Rod trunnion			⊙	○	⊙	○	⊙	○	⊙	○
XC35	With coil scraper	⊙		○	⊙	○	⊙	○	⊙	○	
XC65	Made of stainless steel (Combination of XC7 and XC68)	⊙		○	⊙	○	○	○	⊙	○	
XC68	Made of stainless steel (with hard chrome plated piston rod)	⊙		○	⊙	○	⊙	○	⊙	○	
XC88	Spatter resistant coil scraper, Lube-retainer, Grease for welding (Piston rod: Stainless steel 304)	⊙		○	⊙	○	⊙	○	⊙	○	
XC89	Spatter resistant coil scraper, Lube-retainer, Grease for welding (Piston rod: S45C)	⊙		○	⊙	○	⊙	○	⊙	○	
XC91	Spatter resistant coil scraper, Grease for welding (Piston rod: S45C)	⊙		○	⊙	○	⊙	○	⊙	○	
X1184	Cylinder with heat resistant reed auto switch (-10 to 120°C)	⊙		○	○	○	○	○	○	○	

Note 1) For details, refer to the **Web Catalog**.

Note 2) For details about the smooth cylinder, refer to the **Web Catalog**.

Note 3) Simple specials except XC14A and XC14B.

Note 4) XC10 specification for the MBK-Z series is the non-rotating type on both sides. For only one side, submit a special order request form.

Note 5) Copper-free for the externally exposed part. For details, refer to the **Web Catalog**.

MBK-Z (Non-rotating rod type)				MBB ^{Note 6)} (With end lock)		MBY-Z ^{Note 2)} (Smooth Cylinder)	
Double acting							
Single rod		Double rod		Single rod		Single rod	
Air	Rubber	Air	Rubber	Air		___ ^{Note 9)}	
498		502		506		Web Catalog	
ø32 to ø100							
							Symbol
●	●	●	●	●	●	●	Standard
○	○	○	○	○	○	○	Long st
●	●	●	●	●	●	●	D
●	●	●	●	●	○	○	MB□-□ ^d _k
—	—	—	—	○	—	—	25A
—	—	—	—	○	—	—	MB□ ^f _v
—	—	—	—	○	—	—	10-
—	—	—	—	○	—	—	20-
◎	◎	○	○	◎	◎	◎	XA□
○	○	○	○	○	○	○	XB5
○	○	○	○	○	○	—	XB6
○	○	○	○	○	○	—	XB13
◎	◎	◎	◎	○	○	○	XC3
—	—	—	—	○	—	—	XC4
○	○	○	○	○	—	—	XC5
___ ^{Note 8)}	___ ^{Note 8)}	—	—	○	—	—	XC6
◎	◎	◎	◎	○	◎	◎	XC7
◎	◎	—	—	○	○	○	XC8
◎	◎	—	—	○	○	○	XC9
◎ ^{Note 4)}	◎ ^{Note 4)}	—	—	◎	○	○	XC10
○	○	—	—	○	○	○	XC11
○	○	○	○	○	—	—	XC12
◎	◎	○	○	◎ ^{Note 3)}	◎	◎	XC14
○	○	○	○	○	—	—	XC22
—	—	—	—	—	—	—	XC26
◎	◎	○	○	◎	◎	◎	XC27
○	○	○	○	◎	◎	◎	XC29
◎	◎	○	○	◎	◎	◎	XC30
—	—	—	—	○	—	—	XC35
—	—	—	—	○	◎	◎	XC65
—	—	—	—	—	◎	◎	XC68
—	—	—	—	—	—	—	XC88
—	—	—	—	—	—	—	XC89
—	—	—	—	—	—	—	XC91
○	○	○	○	○	—	—	X1184

Note 6) The cover shape is the same as the current product.

Note 7) The XC3BB, XC3CC and XC3DD with trunion bracket are available with new models (part numbers with *Z).

Note 8) The piston rod of the MBK-Z series is made of stainless steel. The rod end nut made of stainless steel is available with X1292.

Note 9) The copper and fluorine-free specification is available as a standard product.

Note 10) Use a smooth cylinder. For details, refer to the **Web Catalog**.

Air Cylinder: Standard Type Double Acting, Single Rod

MB Series

ø32, ø40, ø50, ø63, ø80, ø100, ø125

RoHS

How to Order

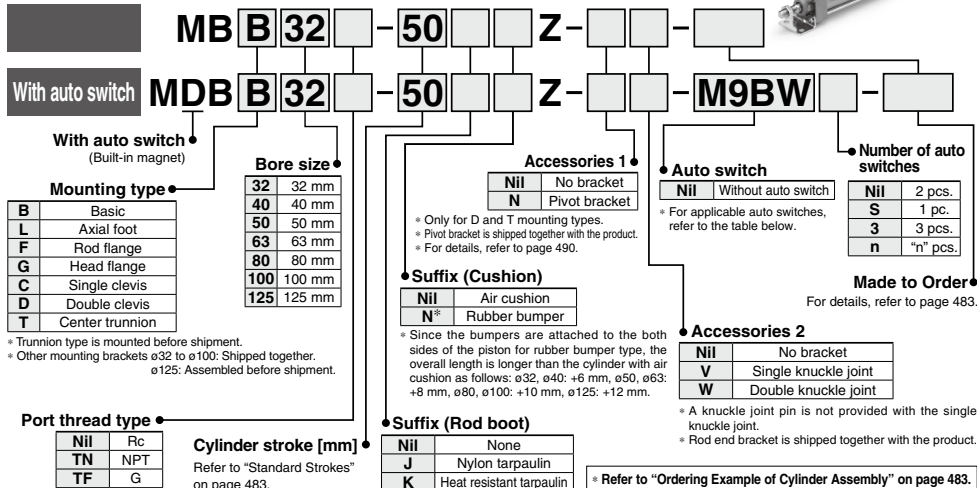

Applicable Auto Switches/Refer to the pages 1271 to 1365 for further information on auto switches.

Type	Special function	Electrical entry	Indicator light	Wiring (Output)	Load voltage		Auto switch model	Lead wire length [m]					Pre-wired connector	Applicable load										
					DC	AC		0.5 (Nil)	1 (M)	3 (L)	5 (Z)													
Solid state auto switch	—	Grommet	No	3-wire (NPN)	24 V	5 V, 12 V	—	M9N	●	●	●	○	○	IC circuit										
				3-wire (PNP)				M9P	●	●	●	○	○											
		Terminal conduit	Yes	2-wire	5 V, 12 V	12 V	—	—	G39	●	●	●	○	○	—									
				3-wire (NPN)					24 V	5 V, 12 V	12 V	—	—	—		—	—							
	Diagnostic indication (2-color indicator)	Grommet	Yes	2-wire	24 V	5 V, 12 V	—	—							—			—	—	—	—	Relay, PLC		
				3-wire (NPN)					M9NW	●	●	●	○	○										
				3-wire (PNP)					M9PW	●	●	●	○	○										
				2-wire					M9B	●	●	●	○	○										
				3-wire (NPN)					M9NA ^{*1}	—	○	○	●	○		○								
				3-wire (PNP)					M9PA ^{*1}	—	○	○	●	○		○								
Water resistant (2-color indicator)	Grommet	No	2-wire	24 V	5 V, 12 V	—	—	—	—	—	—	—	IC circuit											
			4-wire (NPN)											M9BA ^{*1}	—	○	○	●	○	○				
			2-wire (Non-polar)											F59F	—	●	—	●	○	○				
			—											P3DWA	—	●	—	●	○	○				
Reed auto switch	—	Grommet	Yes	2-wire (NPN equivalent)	24 V	5 V	—	—	—	—	—	—	IC circuit	—										
				No											—	12 V	100 V	A96	—	●	●	●	—	—
															—			A93	—	●	●	●	—	
															—			A90	—	●	—	●	—	
															—			A54	—	●	—	●	—	
		Terminal conduit	No	Yes	2-wire	24 V	12 V	200 V or less	—	—	—	—	—	—	—	Relay, PLC								
																	—	A64	—	●	—	●	—	
																	—	—	—	—	—	—	—	
																	—	A33	—	—	—	—	—	
																	—	A34	—	—	—	—	—	
DIN terminal	Grommet	Yes	2-wire	24 V	100 V, 200 V	—	—	—	—	—	—	—	—	PLC										
															—	A44	—	—	—	—	—			
Diagnostic indication (2-color indicator)	Grommet	No	2-wire	24 V	—	—	—	—	—	—	—	—	—	Relay, PLC										
															—	A59W	—	●	—	●	—			

*1 Water resistant type auto switches can be mounted on the above models, but in such case SMC cannot guarantee water resistance.

A water resistant type cylinder is recommended for use in an environment which requires water resistance.

* Lead wire length symbols: 0.5 m.....Nil (Example) M9NW 3 m.....L (Example) M9NWL
1 m.....M (Example) M9NWM 5 m.....Z (Example) M9NZ

* Solid state auto switches marked with "○" are produced upon receipt of order.

* Since there are other applicable auto switches than listed above, refer to page 522 for details.

* The D-A9□/M9□/P3DWA□ auto switches are shipped together, (but not assembled). (However, auto switch mounting brackets are assembled for the D-A9□/M9□ before shipment.)



Symbol

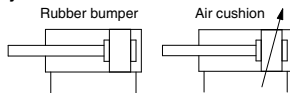

Made to Order: Individual Specifications
(For details, refer to page 523.)

Symbol	Specifications
-X1184	Cylinder with heat resistant reed auto switch (-10 to 120°C)

Made to Order

[Click here for details](#)

Symbol	Specifications
-XA□	Change of rod end shape
-XB5	Oversized rod cylinder*1 #2 #3
-XB6	Heat resistant cylinder (-10 to 150°C)
-XC3	Special port location*3
-XC4	With heavy duty scraper
-XC5	Heat resistant cylinder (-10 to 110°C)
-XC6	Made of stainless steel*4
-XC7	Tie-rod, cushion valve, tie-rod nut, etc. made of stainless steel
-XC8	Adjustable stroke cylinder/Adjustable extension type
-XC9	Adjustable stroke cylinder/Adjustable retraction type
-XC10	Dual stroke cylinder/Double rod type
-XC11	Dual stroke cylinder/Single rod type
-XC12	Tandem cylinder
-XC14	Change of trunnion bracket mounting position
-XC22	Fluororubber seal
-XC26	With split pins for double clevis pin/double knuckle joint pin and flat washers*4
-XC27	Double clevis and double knuckle joint pins made of stainless steel
-XC29	Double knuckle joint with spring pin
-XC30	Rod trunnion
-XC35	With coil scraper
-XC65	Made of stainless steel (Combination of XC7 and XC68)*2
-XC68	Made of stainless steel (with hard chrome plated piston rod)*2
-XC88	Spatter resistant coil scraper, Lubo-retainer, Grease for welding (Piston rod: Stainless steel 304)
-XC89	Spatter resistant coil scraper, Lubo-retainer, Grease for welding (Piston rod: S45C)
-XC91	Spatter resistant coil scraper, Grease for welding (Piston rod: S45C)

*1 Air cushion only

*2 Except ø125

*3 The cover shape is the same as the current product.

*4 ø125 only

For special port location (-XC3), the mounting bracket and port location can be determined using the standard product corresponding to the operating conditions. Also, this is only applicable to -XC3BB, -XC3CC and -XC3DD with trunnion bracket.

For parts made of stainless steel (-XC6), use the same specification stainless steel with the surface treatment (with hard chrome plated piston rod) (-XC68).

Specifications

Bore size [mm]	32	40	50	63	80	100	125
Action	Double acting, Single rod						
Fluid	Air						
Proof pressure	1.5 MPa						
Maximum operating pressure	1.0 MPa						
Minimum operating pressure	0.05 MPa						
Ambient and fluid temperature	Without auto switch: -10 to 70°C With auto switch: -10 to 60°C (No freezing)						
Lubricant	Not required (Non-lube)						
Piston speed	50 to 1000 mm/s						
Stroke length tolerance	Up to 250: $^{+1.0}_0$, 251 to 1000: $^{+1.4}_0$, 1001 to 1500: $^{+1.8}_0$, 1501 to 2000: $^{+2.2}_0$						
Cushion	Air cushion or Rubber bumper						
Port size (Rc)	1/8	1/4	3/8	1/2			
Mounting	Basic, Axial foot, Rod flange, Head flange Single clevis, Double clevis, Center trunnion						

Standard Strokes

Bore size	Standard stroke			Max. manufacturable stroke
	Stroke range ①		Stroke range ②	
	[mm]			
32	25, 50, 75, 100, 125, 150, 175, 200, 250, 300, 350, 400, 450, 500		Up to 1000	Up to 2700
40	25, 50, 75, 100, 125, 150, 175, 200, 250, 300, 350, 400, 450, 500		Up to 1800	
50	25, 50, 75, 100, 125, 150, 175, 200, 250, 300, 350, 400, 450, 500, 600			
63	25, 50, 75, 100, 125, 150, 175, 200, 250, 300, 350, 400, 450, 500, 600			
80	25, 50, 75, 100, 125, 150, 175, 200, 250, 300, 350, 400, 450, 500, 600, 700, 800		Up to 2000	
100	25, 50, 75, 100, 125, 150, 175, 200, 250, 300, 350, 400, 450, 500, 600, 700, 800			
125	25, 50, 75, 100, 125, 150, 175, 200, 250, 300, 350, 400, 450, 500, 600, 700, 800, 900, 1000		Up to 2000	

Note 1) Manufacture of intermediate strokes is possible. (Spacers are not used.)

Note 2) Applicable strokes should be confirmed according to the usage. For details, refer to "Air Cylinders Model Selection" on pages 8 to 19. In addition, the products that exceed the stroke range ① might not be able to fulfill the specifications due to the deflection etc.

Note 3) Please consult with SMC for manufacturability and the part numbers when exceeding the stroke range ②.

Note 4) The stroke range with rod boot is up to 1000 mm. Please consult with SMC when exceeding 1000 mm strokes.

Note 5) Using a stroke of a length which is smaller than the effective cushion length may result in reduced air cushion performance. Refer to "Technical Data 1" on page 1573 for details on the effective cushion length.

Ordering Example of Cylinder Assembly

Cylinder model: **MDBD32-50Z-NW-M9BW**

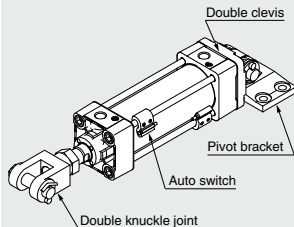

Mounting D: Double clevis
Pivot bracket N: Yes
Rod end bracket W: Double knuckle joint
Auto switch D-M9BW: 2 pcs.

* Pivot bracket, double knuckle joint and auto switch are shipped together with the product, but not assembled.

Refer to pages 515 to 522 for cylinders with auto switches.

- Auto switch proper mounting position (detection at stroke end) and its mounting height
- Minimum stroke for auto switch mounting
- Auto switch mounting brackets/Part no.
- Operating range

MB Series

Accessories

Mounting		Basic	Axial foot	Rod flange	Head flange	Single clevis	Double clevis	Center trunnion
Standard	Rod end nut	●	●	●	●	●	●	●
	Clevis pin	—	—	—	—	—	●	—
Option	Single knuckle joint	●	●	●	●	●	●	●
	Double knuckle joint (with pin)	●	●	●	●	●	●	●
	Rod boot	●	●	●	●	●	●	●

* Refer to page 491 for dimensions and part numbers. (Refer to page 486 for rod boot.)

Mounting Brackets/Part No.

Bore size [mm]	32	40	50	63	80	100	125
Axial foot Note 1)	MB-L03	MB-L04	MB-L05	MB-L06	MB-L08	MB-L10	MB-L12
Rod/Head flange	MB-F03	MB-F04	MB-F05	MB-F06	MB-F08	MB-F10	MB-F12
Single clevis	MB-C03	MB-C04	MB-C05	MB-C06	MB-C08	MB-C10	MB-C12
Double clevis	MB-D03	MB-D04	MB-D05	MB-D06	MB-D08	MB-D10	MB-D12

Note 1) Order two foots per cylinder.

Note 2) Accessories for each mounting bracket are as follows.

Axial foot, Rod/Head flange, Single clevis/Body mounting bolt; Double clevis/Body mounting bolt, Clevis pin, Flat washers and Split pins. → Refer to page 491 for details.

Theoretical Force

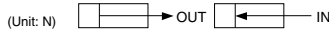

Bore size [mm]	Rod diameter [mm]	Operating direction	Piston area [mm ²]	Operating pressure [MPa]									
				0.2	0.3	0.4	0.5	0.6	0.7	0.8	0.9	1.0	
32	12	OUT	804	161	241	322	402	482	563	643	724	804	
		IN	691	138	207	276	346	415	484	553	622	691	
40	16	OUT	1257	251	377	503	629	754	880	1006	1131	1257	
		IN	1056	211	317	422	528	634	739	845	950	1056	
50	20	OUT	1963	393	589	785	982	1178	1374	1570	1767	1963	
		IN	1649	330	495	660	825	989	1154	1319	1484	1649	
63	20	OUT	3117	623	935	1247	1559	1870	2182	2494	2805	3117	
		IN	2803	561	841	1121	1402	1682	1962	2242	2523	2803	
80	25	OUT	5027	1005	1508	2011	2514	3016	3519	4022	4524	5027	
		IN	4536	907	1361	1814	2268	2722	3175	3629	4082	4536	
100	30	OUT	7854	1571	2356	3142	3927	4712	5498	6283	7069	7854	
		IN	7147	1429	2144	2859	3574	4288	5003	5718	6432	7147	
125	32	OUT	12272	2454	3682	4909	6136	7363	8590	9818	11045	12272	
		IN	11468	2294	3440	4588	5734	6881	8028	9174	10321	11468	

Note) Theoretical force [N] = Pressure [MPa] x Piston area [mm²]

Weights

Bore size [mm]		32	40	50	63	80	100	125
Basic weight	Basic	0.44	0.59	1.04	1.29	2.41	3.36	5.48
	Axial foot	0.56	0.73	1.26	1.57	2.91	4.02	7.56
	Rod/Head flange	0.73	0.96	1.49	2.08	3.86	5.19	9.64
	Single clevis	0.69	0.82	1.38	1.92	3.52	4.94	8.05
	Double clevis	0.7	0.86	1.47	2.08	3.81	5.21	8.25
	Center trunnion	0.73	0.95	1.52	2.09	3.96	5.05	8.46
Additional weight per 50 mm of stroke	All mounting brackets	0.11	0.16	0.26	0.27	0.42	0.56	0.71
Accessories	Single knuckle joint	0.15	0.23	0.26	0.26	0.60	0.83	1.08
	Double knuckle joint (with pin)	0.22	0.37	0.43	0.43	0.87	1.27	1.58

Rod Boot Material

Symbol	Material	Max. ambient temp.
J	Nylon tarpaulin	70°C
K	Heat resistant tarpaulin	110°C*

* Max. ambient temperature for rod boot itself.

Allowable Kinetic Energy

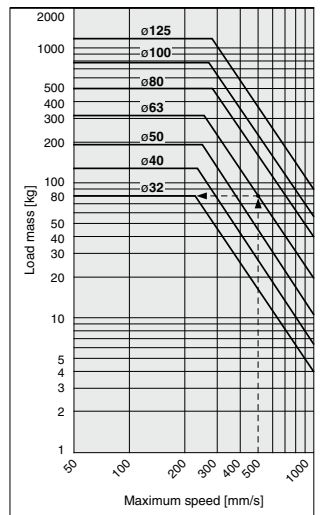

Example) Load limit at rod end when the air cylinder ø63 is actuated at 500 mm/s.

Extend upward from 500 mm/s on the horizontal axis of the graph to the intersection point with the line for a tube bore size of 63 mm, and then extend leftward from this point to find the load of 80 kg.

Calculation

Example) **MBB32-100Z** (Basic, ø32, 100 stroke)

• Basic weight..... 0.44 (Basic, ø32)

• Additional weight..... 0.11/50 stroke

• Cylinder stroke..... 100 stroke

0.44 + 0.11 x 100/50 = **0.66 kg**

Construction

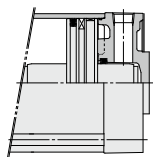
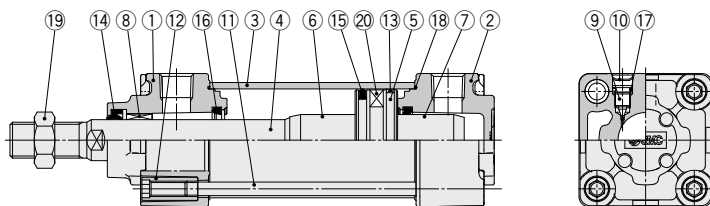

MB125

Component Parts

No.	Description	Material	Q'ty	Note
1	Rod cover	Aluminum die-cast	1	Trivalent chromated
2	Head cover	Aluminum die-cast	1	Trivalent chromated
3	Cylinder tube	Aluminum alloy	1	Hard anodized
4	Piston rod	Carbon steel	1	Hard chrome plating
5	Piston	Aluminum alloy	1	
6	Cushion ring	Aluminum alloy	1	Anodized
7	Cushion ring B	Aluminum alloy	1	Anodized
8	Bushing	Bearing alloy	1	
9	Cushion valve	Steel wire	2	Trivalent zinc chromated
10	Retaining ring	Steel for spring	2	ø40 to ø125

No.	Description	Material	Q'ty	Note
11	Tie-rod	Carbon steel	4	Trivalent zinc chromated
12	Tie-rod nut	Carbon steel	8	Trivalent zinc chromated
13	Wear ring	Resin	1	
14	Rod seal	NBR	1	
15	Piston seal	NBR	1	
16	Cushion seal	Urethane	2	
17	Cushion valve seal	NBR	2	
18	Cylinder tube gasket	NBR	2	
19	Rod end nut	Rolled steel	1	Trivalent zinc chromated
20	Magnet	—	(1)	

Replacement Parts/Seal Kit

Bore size [mm]	Kit no.	Contents
32	MB32Z-PS	Set of the nos. 14, 15, 16, 18
40	CA2-40Z-PS	
50	CA2-50Z-PS	
63	CA2-63Z-PS	
80	CA2-80Z-PS	
100	CA2-100Z-PS	
125	MB125-PS	

* Seal kits consist of items 14, 15, 16, 18, and can be ordered by using the seal kit number corresponding to each bore size.

* Center trunnion type should not be disassembled. (Refer to page 524.)

* The seal kit includes a grease pack (10 g for ø32 to ø50, 20 g for ø63 and ø80, 30 g for ø100 and ø125).

Order with the following part number when only the grease pack is needed.

Grease pack part number: GR-S-010 (10 g), **GR-S-020** (20 g)

Water Resistant Air Cylinder

Water resistant air cylinders are also available in the MB series, which are suitable for use on machine tools, where exposure to coolant is possible and applicable for food machinery and automobile washing equipment in an environment where water splashes. Please refer to page 1189 for more information.

MB Series

Standard

Basic: (B)

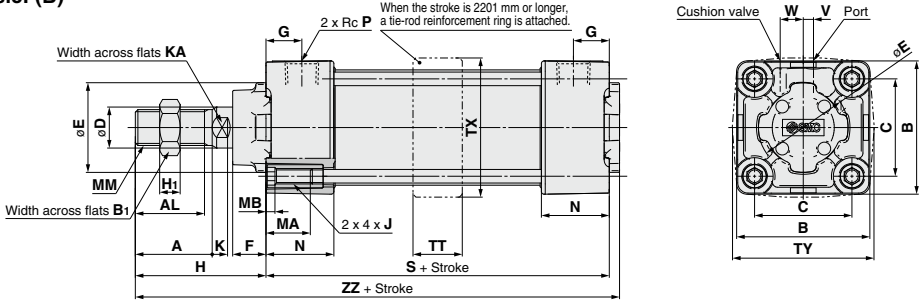

With rod boot

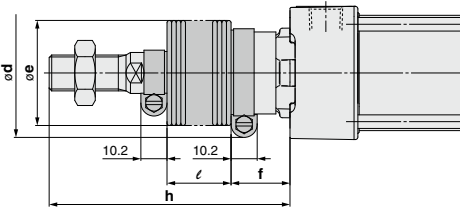

Bore size [mm]	A	AL	B	B ₁	C	D	E	F	G	H	H ₁	J	K	KA	MA	MB	MM	N	P	S	TT	TX	TY	V	W	ZZ
32	22	19.5	46	17	32.5	12	30	13	13	47	6	M6 x 1	6	10	16	4	M10 x 1.25	27	1/8	84	17	48	49	4	6.5	135
40	30	27	52	22	38	16	35	13	14	51	8	M6 x 1	6	14	16	4	M14 x 1.5	27	1/4	84	22	55	58	4	9	139
50	35	32	65	27	46.5	20	40	14	15.5	58	11	M8 x 1.25	7	18	16	5	M18 x 1.5	31.5	1/4	94	22	68	71	5	10.5	156
63	35	32	75	27	56.5	20	45	14	16.5	58	11	M8 x 1.25	7	18	16	5	M18 x 1.5	31.5	3/8	94	28	81	81	9	12	156
80	40	37	95	32	72	25	45	20	19	72	13	M10 x 1.5	10	22	16	5	M22 x 1.5	38	3/8	114	34	102	102	11.5	14	190
100	40	37	114	41	89	30	55	20	19	72	16	M10 x 1.5	10	26	16	5	M26 x 1.5	38	1/2	114	40	124	124	17	15	190
125	54	50	136	41	110	32	60	27	19	97	16	M12 x 1.75	13	27	20	6	M27 x 2	38	1/2	120	50	148	148	17	15	223

With Rod Boot

Bore size [mm]	d	e	f	ℓ															
				1 to 50	51 to 100	101 to 150	151 to 200	201 to 300	301 to 400	401 to 500	501 to 600	601 to 700	701 to 800	801 to 900	901 to 1000				
32	54	36	23	12.5	25	37.5	50	75	100	125	150	175	200	225	250				
40	56	41	23	12.5	25	37.5	50	75	100	125	150	175	200	225	250				
50	64	51	25	12.5	25	37.5	50	75	100	125	150	175	200	225	250				
63	64	51	25	12.5	25	37.5	50	75	100	125	150	175	200	225	250				
80	68	56	29	12.5	25	37.5	50	75	100	125	150	175	200	225	250				
100	76	61	29	12.5	25	37.5	50	75	100	125	150	175	200	225	250				
125	82	75	27	10	20	30	40	60	80	100	120	140	160	180	200				

Bore size [mm]	h												Rubber Bumper		
	1 to 50	51 to 100	101 to 150	151 to 200	201 to 300	301 to 400	401 to 500	501 to 600	601 to 700	701 to 800	801 to 900	901 to 1000	Bore size [mm]	S	ZZ
32	73	86	98	111	136	161	186	211	236	261	286	311	32	90	141
40	81	94	106	119	144	169	194	219	244	269	294	319	40	90	145
50	89	102	114	127	152	177	202	227	252	277	302	327	50	102	164
63	89	102	114	127	152	177	202	227	252	277	302	327	63	102	164
80	101	114	126	139	164	189	214	239	264	289	314	339	80	124	200
100	101	114	126	139	164	189	214	239	264	289	314	339	100	124	200
125	120	130	140	150	170	190	210	230	250	270	290	310	125	132	235

* Model without air cushion is designed to include rubber bumpers. Since the bumpers are attached to the both sides of the piston, the overall length is longer than the cylinder with air cushion as follows: $\phi 32$, $\phi 40$: +6 mm, $\phi 50$, $\phi 63$: +8 mm, $\phi 80$, $\phi 100$: +10 mm, $\phi 125$: +12 mm

Standard/With Mounting Bracket

* Refer to Basic (B) for other dimensions.

Axial foot: (L)

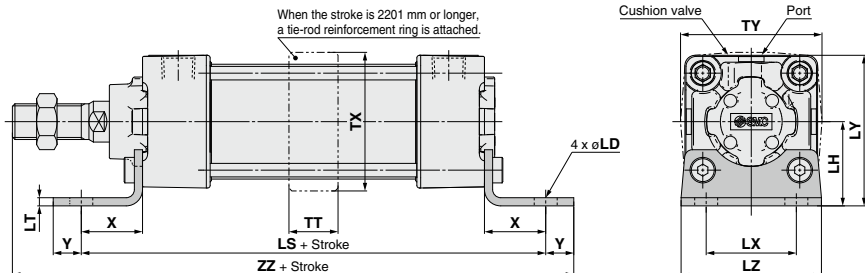

Bore size [mm]	LD	LH	LS	LT	LX	LY	LZ	TT	TX	TY	X	Y	ZZ
32	7	30	128	3.2	32	53	50	17	48	49	22	9	162
40	9	33	132	3.2	38	59	55	22	55	58	24	11	170
50	9	40	148	3.2	46	72.5	70	22	68	71	27	11	190
63	12	45	148	3.6	56	82.5	80	28	81	81	27	14	193
80	12	55	174	4.5	72	102.5	100	34	102	102	30	14	230
100	14	65	178	4.5	89	122	120	40	124	124	32	16	234
125	14	81	210	8	90	149	136	50	148	148	45	20	282

Rubber Bumper

Bore size [mm]	LS	ZZ
32	134	168
40	138	176
50	156	198
63	156	201
80	184	240
100	188	244
125	222	294

* Model without air cushion is designed to include rubber bumpers. Since the bumpers are attached to the both sides of the piston, the overall length is longer than the cylinder with air cushion as follows: ø32, ø40: +6 mm, ø50, ø63: +8 mm, ø80, ø100: +10 mm, ø125: +12 mm

Rod flange: (F)

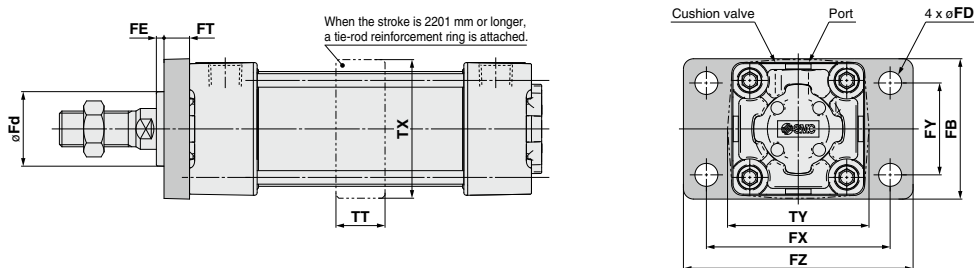

Bore size [mm]	FB	FD	FE	FT	FX	FY	FZ	Fd	TT	TX	TY
32	50	7	3	10	64	32	79	24.5	17	48	49
40	55	9	3	10	72	36	90	29.5	22	55	58
50	70	9	2	12	90	45	110	35.5	22	68	71
63	80	9	2	12	100	50	120	38.5	28	81	81
80	100	12	4	16	126	63	153	41	34	102	102
100	120	14	4	16	150	75	178	46	40	124	124
125	138	14	7	20	180	102	216	57	50	148	148

* Model without air cushion is designed to include rubber bumpers. Since the bumpers are attached to the both sides of the piston, the overall length is longer than the cylinder with air cushion as follows: ø32, ø40: +6 mm, ø50, ø63: +8 mm, ø80, ø100: +10 mm, ø125: +12 mm

MB Series

Standard/With Mounting Bracket

* Refer to Basic (B) for other dimensions.

Head flange: (G)

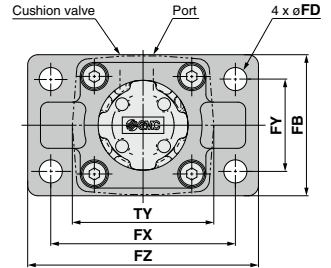
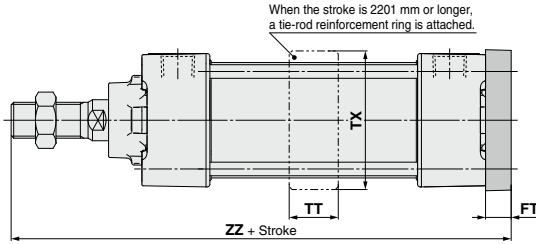

Bore size [mm]	FB	FD	FT	FX	FY	FZ	TT	TX	TY	ZZ
32	50	7	10	64	32	79	17	48	49	141
40	55	9	10	72	36	90	22	55	58	145
50	70	9	12	90	45	110	22	68	71	164
63	80	9	12	100	50	120	28	81	81	164
80	100	12	16	126	63	153	34	102	102	202
100	120	14	16	150	75	178	40	124	124	202
125	138	14	20	180	102	216	50	148	148	237

Rubber Bumper

Bore size [mm]	ZZ
32	147
40	151
50	172
63	172
80	212
100	212
125	249

* Model without air cushion is designed to include rubber bumpers. Since the bumpers are attached to the both sides of the piston, the overall length is longer than the cylinder with air cushion as follows: $\phi 32, \phi 40$: +6 mm, $\phi 50, \phi 63$: +8 mm, $\phi 80, \phi 100$: +10 mm, $\phi 125$: +12 mm

Single clevis: (C)

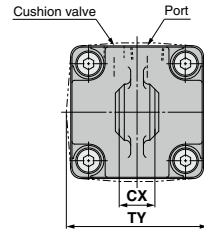
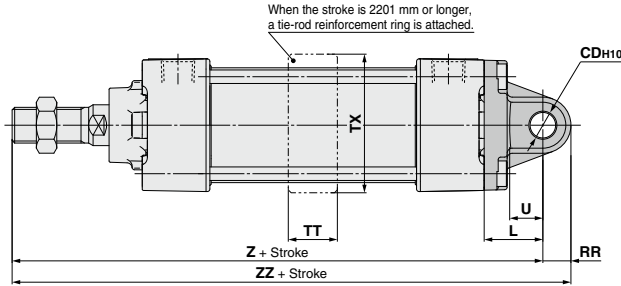

Bore size [mm]	CDH10	CX	L	RR	TT	TX	TY	U	Z	ZZ
32	$10^{+0.058}_0$	$14^{+0.1}_{-0.3}$	23	10.5	17	48	49	13	154	164.5
40	$10^{+0.058}_0$	$14^{+0.1}_{-0.3}$	23	11	22	55	58	13	158	169
50	$14^{+0.070}_0$	$20^{+0.1}_{-0.3}$	30	15	22	68	71	17	182	197
63	$14^{+0.070}_0$	$20^{+0.1}_{-0.3}$	30	15	28	81	81	17	182	197
80	$22^{+0.084}_0$	$30^{+0.1}_{-0.3}$	42	23	34	102	102	26	228	251
100	$22^{+0.084}_0$	$30^{+0.1}_{-0.3}$	42	23	40	124	124	26	228	251
125	$25^{+0.084}_0$	$32^{+0.1}_{-0.3}$	50	28	50	148	148	30	267	295

Rubber Bumper

Bore size [mm]	Z	ZZ
32	160	170.5
40	164	175
50	190	205
63	190	205
80	238	261
100	238	261
125	279	307

* Model without air cushion is designed to include rubber bumpers. Since the bumpers are attached to the both sides of the piston, the overall length is longer than the cylinder with air cushion as follows: $\phi 32, \phi 40$: +6 mm, $\phi 50, \phi 63$: +8 mm, $\phi 80, \phi 100$: +10 mm, $\phi 125$: +12 mm

Standard/With Mounting Bracket

* Refer to Basic (B) for other dimensions.

Double clevis: (D)

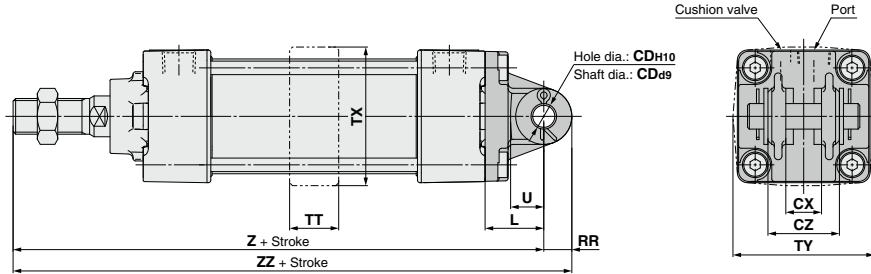

Bore size [mm]	CDH10	CDø9	CX	CZ	L	RR	TT	TX	TY	U	Z	ZZ
32	10 ^{+0.058} ₀	10 ^{-0.040} _{-0.076}	14 ^{+0.3} _{+0.1}	28	23	10.5	17	48	49	13	154	164.5
40	10 ^{+0.058} ₀	10 ^{-0.04} _{-0.076}	14 ^{+0.3} _{+0.1}	28	23	11	22	55	58	13	158	169
50	14 ^{+0.070} ₀	14 ^{-0.050} _{-0.093}	20 ^{+0.3} _{+0.1}	40	30	15	22	68	71	17	182	197
63	14 ^{+0.070} ₀	14 ^{-0.050} _{-0.093}	20 ^{+0.3} _{+0.1}	40	30	15	28	81	81	17	182	197
80	22 ^{+0.084} ₀	22 ^{-0.065} _{-0.117}	30 ^{+0.3} _{+0.1}	60	42	23	34	102	102	26	228	251
100	22 ^{+0.084} ₀	22 ^{-0.065} _{-0.117}	30 ^{+0.3} _{+0.1}	60	42	23	40	124	124	26	228	251
125	25 ^{+0.084} ₀	25 ^{-0.065} _{-0.117}	32 ^{+0.3} _{+0.1}	64	50	28	50	148	148	30	267	295

Rubber Bumper

Bore size [mm]	Z	ZZ
32	160	170.5
40	164	175
50	190	205
63	190	205
80	238	261
100	238	261
125	279	307

* Model without air cushion is designed to include rubber bumpers. Since the bumpers are attached to the both sides of the piston, the overall length is longer than the cylinder with air cushion as follows: ø32, ø40: +6 mm, ø50, ø63: +8 mm, ø80, ø100: +10 mm, ø125: +12 mm

Center trunnion: (T)

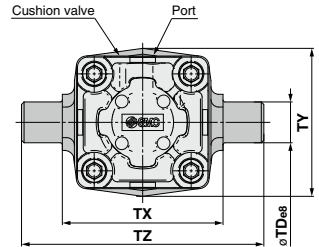
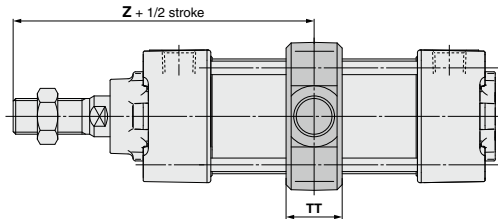

Bore size [mm]	TDø8	TT	TX	TY	TZ	Z
32	12 ^{-0.032} _{-0.059}	17	50	49	74	89
40	16 ^{-0.032} _{-0.059}	22	63	58	95	93
50	16 ^{-0.032} _{-0.059}	22	75	71	107	105
63	20 ^{-0.040} _{-0.073}	28	90	87	130	105
80	20 ^{-0.040} _{-0.073}	34	110	110	150	129
100	25 ^{-0.040} _{-0.073}	40	132	136	182	129
125	25 ^{-0.040} _{-0.073}	50	160	160	210	157

* Model without air cushion is designed to include rubber bumpers. Since the bumpers are attached to the both sides of the piston, the "Z" dimension is longer than the cylinder with air cushion as follows: ø32, ø40: +3 mm, ø50, ø63: +4 mm, ø80, ø100: +5 mm, ø125: +6 mm

MB Series

Pivot Bracket/Trunnion and Double Clevis Pivot Bracket

Part No.

Bore size	MB□32	MB□40	MB□50	MB□63	MB□80	MB□100	MB□125
Description	MB-S03	MB-S04	MB-S06	MB-S10	MB-S12		
Trunnion pivot bracket (Note)	MB-S03		MB-S04		MB-S06		MB-S10
Double clevis pivot bracket	MB-B03		MB-B05		MB-B08		MB-B12

(Note) Order 2 trunnion pivot brackets per cylinder.

Trunnion pivot bracket

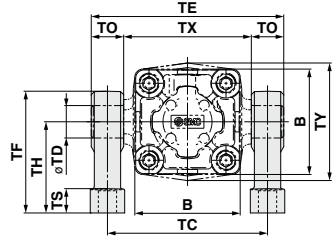
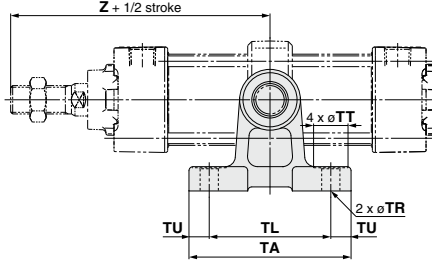

Part no.	Bore size [mm]	B	TA	TL	TU	TC	TX	TE	TO	TR	TT	TS	TH	TF	Z**	TD _{H10}
MB-S03	32	46	62	45	8.5	62	50	74	12	7	13	10	35	47	89	12 ^{+0.070} ₀
	40	52	80	60	10	80	63	97	17	9	17	12	45	60	93	16 ^{+0.070} ₀
MB-S04	50	65	80	60	10	92	75	109	17	9	17	12	45	60	105	16 ^{+0.070} ₀
	63	75	100	70	15	110	90	130	20	11	22	14	60	80	105	20 ^{+0.084} ₀
MB-S06	80	95	100	70	15	130	110	150	20	11	22	14	60	80	129	20 ^{+0.084} ₀
	100	114	120	90	15	158	132	184	26	13.5	24	17	75	100	129	25 ^{+0.084} ₀
MB-S12	125	136	142	105	18.5	186	160	212	26	13.5	24	25	85	115	157	25 ^{+0.084} ₀

Rubber Bumper

Bore size [mm]	Z
32	92
40	96
50	109
63	109
80	134
100	134
125	163

Double clevis pivot bracket

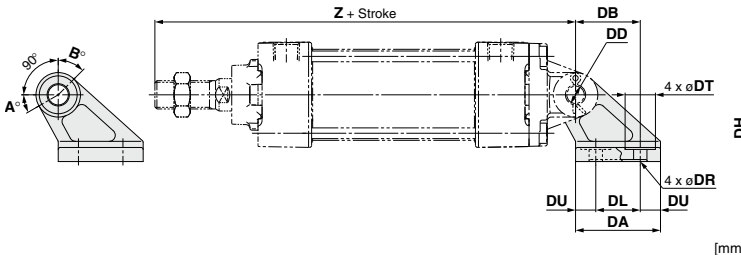

Part no.	Bore size [mm]	B	DA	DB	DL	DU	DC	DX	DE	DO	DR	DT	DS	DH	Z**	DD _{H10}
MB-B03	32	46	42	32	22	10	44	14	62	9	6.6	15	7	33	154	10 ^{+0.058} ₀
	40	52	42	32	22	10	44	14	62	9	6.6	15	7	33	158	10 ^{+0.058} ₀
MB-B05	50	65	53	43	30	11.5	60	20	81	10.5	9	18	8	45	182	14 ^{+0.070} ₀
	63	75	53	43	30	11.5	60	20	81	10.5	9	18	8	45	182	14 ^{+0.070} ₀
MB-B08	80	95	73	64	45	14	86	30	111	12.5	11	22	10	65	228	22 ^{+0.084} ₀
	100	114	73	64	45	14	86	30	111	12.5	11	22	10	65	228	22 ^{+0.084} ₀
MB-B12	125	136	90	78	60	15	110	32	136	13	13.5	24	14	75	267	25 ^{+0.084} ₀

Rubber Bumper

Bore size [mm]	Z
32	160
40	164
50	190
63	190
80	238
100	238
125	279

Rotating Angle

Bore size [mm]	A°	B°	A° + B° + 90°
32, 40	25°	45°	160°
50, 63	40°	60°	190°
80, 100	30°	55°	175°
125	30°	50°	170°

** Model without air cushion is designed to include rubber bumpers.

Since the bumpers are attached to the both sides of the piston, the "Z" dimension is longer than the cylinder with air cushion as follows: ø32, ø40: +3 mm, ø50, ø63: +4 mm, ø80, ø100: +5 mm, ø125: +6 mm

* Model without air cushion is designed to include rubber bumpers.

Since the bumpers are attached to the both sides of the piston, the overall length is longer than the cylinder with air cushion as follows: ø32, ø40: +6 mm, ø50, ø63: +8 mm, ø80, ø100: +10 mm, ø125: +12 mm

Dimensions of Accessories

Rod end nut
(Standard)

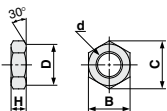

(mm)

Part no.	Bore size [mm]	d	H	B	C	D
NT-03	32	M10 x 1.25	6	17	19.6	16.5
NT-04	40	M14 x 1.5	8	22	25.4	21
NT-05	50, 63	M18 x 1.5	11	27	31.2	26
NT-08	80	M22 x 1.5	13	32	37.0	31
NT-10	100	M26 x 1.5	16	41	47.3	39
NT-12M	125	M27 x 2	16	41	47.3	39

I type
Single knuckle joint

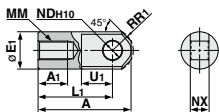

(mm)

Part no.	Bore size [mm]	A	A ₁	E ₁	L ₁	MM	R ₁	U ₁	NDH ₁₀	NX
I-03M	32	40	14	20	30	M10 x 1.25	12	16	10 ^{+0.058} ₀	14 ^{+0.10} _{-0.30}
I-04M	40	50	19	22	40	M14 x 1.5	12.5	19	10 ^{+0.058} ₀	14 ^{+0.10} _{-0.30}
I-05M	50, 63	64	24	28	50	M18 x 1.5	16.5	24	14 ^{+0.070} ₀	20 ^{+0.10} _{-0.30}
I-08M	80	80	26	40	60	M22 x 1.5	23.5	34	22 ^{+0.084} ₀	30 ^{+0.10} _{-0.30}
I-10M	100	80	26	40	60	M26 x 1.5	23.5	34	22 ^{+0.084} ₀	30 ^{+0.10} _{-0.30}
I-12M	125	119	36	46	92	M27 x 2	28.5	34	25 ^{+0.084} ₀	32 ^{+0.10} _{-0.30}

Knuckle joint pin
Clevis pin

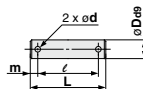

(mm)

Part no.	Bore size [mm] Clevis (knuckle)	D ₀₉	L	ℓ	m	d	Applicable split pin
CD-M03 ^{Note 1)}	32, 40	10 ^{+0.040} _{-0.076}	44	36	4	3	ø3 x 18 ℓ
CD-M05 ^{Note 1)}	50, 63	14 ^{+0.050} _{-0.093}	60	51	4.5	4	ø4 x 25 ℓ
CD-M08 ^{Note 1)}	80, 100	22 ^{+0.075} _{-0.117}	82	72	5	4	ø4 x 35 ℓ
IY-12 ^{Note 2)}	125	25 ^{+0.085} _{-0.117}	79.5	69.5	5	4	ø4 x 40 ℓ

Note 1) Split pins and flat washers are included. Note 2) Only pins are included when stripped.

Y type
Double knuckle joint

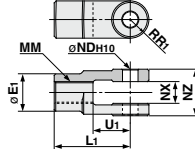

(mm)

Part no.	Bore size [mm]	E ₁	L ₁	MM	R ₁	U ₁	NDH ₁₀	NX	NZ
Y-03M ^{Note 1)}	32	20	30	M10 x 1.25	10	16	10 ^{+0.058} ₀	14 ^{+0.30} _{-0.10}	28 ^{+0.10} _{-0.30}
Y-04M ^{Note 1)}	40	22	40	M14 x 1.5	11	19	10 ^{+0.058} ₀	14 ^{+0.30} _{-0.10}	28 ^{+0.10} _{-0.30}
Y-05M ^{Note 1)}	50, 63	28	50	M18 x 1.5	14	24	14 ^{+0.070} ₀	20 ^{+0.30} _{-0.10}	40 ^{+0.10} _{-0.30}
Y-08M ^{Note 1)}	80	40	65	M22 x 1.5	20	34	22 ^{+0.084} ₀	30 ^{+0.30} _{-0.10}	60 ^{+0.10} _{-0.30}
Y-10M ^{Note 1)}	100	40	65	M26 x 1.5	20	34	22 ^{+0.084} ₀	30 ^{+0.30} _{-0.10}	60 ^{+0.10} _{-0.30}
Y-12M ^{Note 2)}	125	46	100	M27 x 2	27	42	25 ^{+0.084} ₀	32 ^{+0.30} _{-0.10}	64 ^{+0.10} _{-0.30}

Note 1) A pin, split pins and flat washers are included. Note 2) A pin and split pins are included.

Bracket Combinations

Bracket combination available Refer to the figure below.

Bracket for cylinder	Bracket for workpiece				
	Single clevis	Double clevis	Single knuckle joint	Double knuckle joint	Clevis pivot bracket
Single clevis	—	①	—	②	—
Double clevis	③	—	④	—	⑨
Single knuckle joint	—	⑤	—	⑥	—
Double knuckle joint	⑦	—	⑧	—	⑩

No.	Appearance	No.	Appearance
①	Single clevis + Double clevis	⑥	Single knuckle joint + Double knuckle joint
②	Single clevis + Double knuckle joint	⑦	Double knuckle joint + Single clevis
③	Double clevis + Single clevis	⑧	Double knuckle joint + Single knuckle joint
④	Double clevis + Single knuckle joint	⑨	Double clevis + Clevis pivot bracket
⑤	Single knuckle joint + Double clevis	⑩	Double knuckle joint + Clevis pivot bracket

Air Cylinder: Standard Type Double Acting, Double Rod

MBW Series

ø32, ø40, ø50, ø63, ø80, ø100, ø125



How to Order



MBW L 32 [] - 150 [] [] Z - []

With auto switch **MDBW** L 32 [] - 150 [] [] Z - **M9BW** [] - []

With auto switch
(Built-in magnet)

Mounting type

B	Basic
L	Axial foot
F	Rod flange
T	Center trunnion

* Trunnion type is mounted before shipment.
* Other mounting brackets ø32 to ø100: Shipped together. ø125: Assembled before shipment.

Bore size

32	32 mm
40	40 mm
50	50 mm
63	63 mm
80	80 mm
100	100 mm
125	125 mm

Port thread type

Nil	Rc
TN	NPT
TF	G

Cylinder stroke [mm]
Refer to "Standard Strokes" on page 493.

Auto switch

Nil	Without auto switch
S	3
3	3 pcs.
n	"n" pcs.

* For applicable auto switches, refer to the table below.

Number of auto switches

Nil	2 pcs.
S	1 pc.
3	3 pcs.
n	"n" pcs.

Made to Order
For details, refer to page 493.

Suffix (Rod boot)

Nil	None
J	Nylon tarpaulin (one end)
JJ	Nylon tarpaulin (both ends)
K	Heat resistant tarpaulin (one end)
KK	Heat resistant tarpaulin (both ends)

Suffix (Cushion)

Nil	Air cushion
N*	Rubber bumper

* Since the bumpers are attached to the both sides of the piston for rubber bumper type, the overall length is longer than the cylinder with air cushion as follows: ø32, ø40: +6 mm, ø50, ø63: +8 mm, ø80, ø100: +10 mm, ø125: +12 mm.

Applicable Auto Switches/Refer to pages 1271 to 1365 for further information on auto switches.

Type	Special function	Electrical entry	Indicator light	Wiring (Output)	Load voltage		Auto switch model		Lead wire length [m]					Pre-wired connector	Applicable load		
					DC	AC	Tie-rod mounting	Band mounting	0.5 (Nil)	1 (M)	3 (L)	5 (Z)					
													3-wire (NPN)			3-wire (PNP)	2-wire
Solid state auto switch	—	Grommet	No	3-wire (NPN)	24 V	5 V, 12 V	—	M9N	●	●	●	○	○	IC circuit	Relay, PLC		
				3-wire (PNP)				M9P	●	●	●	○	○				
		2-wire		12 V	M9B	●	●	●	○	○							
		3-wire (NPN)		24 V	5 V, 12 V	—	G39	—	—	—	—	—	—	—			
	2-wire	12 V	K39				—	—	—	—	—	—					
	Diagnostic indication (2-color indicator)	Terminal conduit	Yes	3-wire (NPN)	24 V	5 V, 12 V	—	M9NW	●	●	●	○	○	IC circuit			
				3-wire (PNP)				M9PW	●	●	●	○	○				
	Water resistant (2-color indicator)	Grommet	No	3-wire (NPN)	24 V	5 V, 12 V	—	M9NA *1	—	○	○	●	○	IC circuit			
				3-wire (PNP)				M9PA *1	—	○	○	●	○	○			
	Diagnostic output (2-color indicator)	Terminal conduit	Yes	2-wire	24 V	12 V	—	M9BW	●	●	●	○	○	—			
3-wire (NPN)				M9NA *1				—	○	○	●	○	○				
Magnetic field resistant (2-color indicator)	Grommet	No	4-wire (NPN)	24 V	5 V, 12 V	—	F59F	—	●	—	○	○	IC circuit				
			2-wire (Non-polar)				P3DWA	—	●	—	●	●	○	—			
Reed auto switch	—	Grommet	Yes	3-wire (Equiv. to NPN)	24 V	5 V	—	A96	●	—	●	—	—	IC circuit	—		
				100 V				A93	—	●	●	●	—	—			
				100 V or less				A90	—	●	—	●	—	—		IC circuit	
				100 V, 200 V				A54	—	●	—	●	—	—			
		Terminal conduit	Yes	No	2-wire	24 V	12 V	—	A64	—	●	—	●	—	—	PLC	
									—	A33	—	—	—	—	—		—
									—	A34	—	—	—	—	—		—
									100 V, 200 V	A44	—	—	—	—	—		—
Diagnostic indication (2-color indicator)	Grommet	No	2-wire	24 V	—	—	A59W	—	●	—	●	—	—	Relay, PLC			
							—	—	—	—	—	—	—		—		

*1 Water resistant type auto switches can be mounted on the above models, but in such case SMC cannot guarantee water resistance.

* Lead wire length symbols: 0.5 m..... Nil (Example) M9NW 3 m..... L (Example) M9NWL
1 m..... M (Example) M9NWM 5 m..... Z (Example) M9NZ

* Solid state auto switches marked with "○" are produced upon receipt of order.

* Since there are other applicable auto switches than listed above, refer to page 522 for details.

* The D-A9□/M9□/P3DWA□ auto switches are shipped together, (but not assembled). (However, auto switch mounting brackets are assembled for the D-A9□/M9□ before shipment.)



Symbol

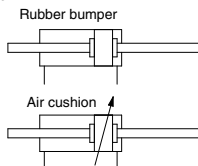

Made to Order
Click here for details

Symbol	Specifications
-XA□	Change of rod end shape
-XB6	Heat resistant cylinder (-10 to 150°C)
-XC3	Special port location*1 *2
-XC4	With heavy duty scraper
-XC5	Heat resistant cylinder (-10 to 110°C)
-XC6	Made of stainless steel*2
-XC7	Tie-rod, cushion valve, tie-rod nut, etc. made of stainless steel
-XC14	Change of trunnion bracket mounting position
-XC22	Fluororubber seal
-XC30	Rod trunnion
-XC35	With coil scraper
-XC68	Made of stainless steel (with hard chrome plated piston rod)*3

*1 The cover shape is the same as the current product.

*2 ø125 only

*3 Except ø125

For special port location (-XC3), the mounting bracket and port location can be determined using the standard product corresponding to the operating conditions. Also, this is only applicable to -XC3BB, -XC3CC and -XC3DD with trunnion bracket.

For parts made of stainless steel (-XC6), use the same specification stainless steel with the surface treatment (with hard chrome plated piston rod) (-XC68).

Refer to pages 515 to 522 for cylinders with auto switches.

- Auto switch proper mounting position (detection at stroke end) and its mounting height
- Minimum stroke for auto switch mounting
- Auto switch mounting brackets/Part no.
- Operating range

Water Resistant Air Cylinder

Water resistant air cylinders are also available in the MB series, which are suitable for use on machine tools in an atmosphere with coolant and applicable to food machinery and automobile washing equipment in an environment with water splashes. Please refer to page 1189 for more information.

Specifications

Bore size [mm]	32	40	50	63	80	100	125
Action	Double acting, Double rod						
Fluid	Air						
Proof pressure	1.5 MPa						
Max. operating pressure	1.0 MPa						
Min. operating pressure	0.05 MPa						
Ambient and fluid temperature	Without auto switch: -10 to 70°C (No freezing) With auto switch: -10 to 60°C						
Lubrication	Not required (Non-lube)						
Operating piston speed	50 to 1000 mm/s						50 to 700 mm/s
Allowable stroke tolerance	Up to 250: $^{+1.0}_0$, 251 to 1000: $^{+1.4}_0$, 1001 to 1500						
Cushion ^{Note)}	Air cushion or Rubber bumper						
Port size (Rc, NPT, G)	1/8	1/4	3/8	1/2			
Mounting	Basic, Axial foot, Rod flange, Center trunnion						

Note) Kinetic energy absorbable by the cushion mechanism is identical to double acting, single rod.

Standard Strokes

Bore size	Standard stroke		Max. manufacturable stroke
	Stroke range ①	Stroke range ②	
32	25, 50, 75, 100, 125, 150, 175, 200, 250, 300, 350, 400, 450, 500	Up to 1000	Up to 1800
40	25, 50, 75, 100, 125, 150, 175, 200, 250, 300, 350, 400, 450, 500		
50	25, 50, 75, 100, 125, 150, 175, 200, 250, 300, 350, 400, 450, 500, 600	Up to 1200	
63	25, 50, 75, 100, 125, 150, 175, 200, 250, 300, 350, 400, 450, 500, 600		
80	25, 50, 75, 100, 125, 150, 175, 200, 250, 300, 350, 400, 450, 500, 600, 700, 800	Up to 1500	
100	25, 50, 75, 100, 125, 150, 175, 200, 250, 300, 350, 400, 450, 500, 600, 700, 800		
125	25, 50, 75, 100, 125, 150, 175, 200, 250, 300, 350, 400, 450, 500, 600, 700, 800, 900, 1000		

Note 1) Manufacture of intermediate strokes is possible. (Spacers are not used.)

Note 2) Applicable strokes should be confirmed according to the usage. For details, refer to "Air Cylinders Model Selection" on pages 8 to 19. In addition, the products that exceed the stroke range ① might not be able to fulfill the specifications due to the deflection etc.

Note 3) Please consult with SMC for manufacturability and the part numbers when exceeding the stroke range ②.

Note 4) The stroke range with rod boot is up to 1000 mm. Please consult with SMC when exceeding 1000 mm strokes.

Note 5) Using a stroke of a length which is smaller than the effective cushion length may result in reduced air cushion performance. Refer to "Technical Data 1" on page 1573 for details on the effective cushion length.

Accessories

Mounting		Basic	Axial foot	Rod flange	Center trunnion
Standard	Rod end nut	●	●	●	●
	Single knuckle joint	●	●	●	●
Option	Double knuckle joint (with pin)	●	●	●	●
	Rod boot	●	●	●	●

* Refer to page 491 for dimensions and part numbers. (Refer to page 496 for rod boot.)

Rod Boot Material

Symbol	Material	Max. ambient temp.
J	Nylon tarpaulin	70°C
K	Heat resistant tarpaulin	110°C*

* Max. ambient temperature for rod boot itself.

Mounting Brackets/Part No.

Bore size [mm]	32	40	50	63	80	100	125
Axial foot	MB-L03	MB-L04	MB-L05	MB-L06	MB-L08	MB-L10	MB-L12
Rod flange	MB-F03	MB-F04	MB-F05	MB-F06	MB-F08	MB-F10	MB-F12

* Order two foots per cylinder.

MBW Series

Theoretical Force

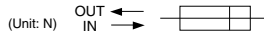

Bore size [mm]	Rod diameter [mm]	Operating direction	Piston area [mm ²]	Operating pressure [MPa]								
				0.2	0.3	0.4	0.5	0.6	0.7	0.8	0.9	1.0
32	12	IN, OUT	691	138	207	276	346	415	484	553	622	691
40	16	IN, OUT	1056	211	317	422	528	634	739	845	950	1056
50	20	IN, OUT	1649	330	495	660	825	989	1154	1319	1484	1649
63	20	IN, OUT	2803	561	841	1121	1402	1682	1962	2242	2523	2803
80	25	IN, OUT	4536	907	1361	1814	2268	2722	3175	3629	4082	4536
100	30	IN, OUT	7147	1429	2144	2859	3574	4288	5003	5718	6432	7147
125	32	IN, OUT	11468	2294	3440	4588	5734	6881	8028	9174	10321	11468

Note) Theoretical force [N] = Pressure [MPa] x Piston area [mm²]

Weights/Aluminum Tube

Bore size [mm]		[kg]						
		32	40	50	63	80	100	125
Basic weight	Basic	0.56	0.78	1.37	1.64	3.05	4.23	6.48
	Axial foot	0.68	0.92	1.59	1.92	3.55	4.89	8.56
	Rod flange	0.85	1.15	1.82	2.43	4.50	6.06	10.64
	Center trunnion	0.85	1.14	1.85	2.44	4.60	5.92	9.46
Additional weight per 50 mm of stroke	All mounting brackets	0.15	0.24	0.37	0.38	0.61	0.82	1.02
Accessories	Single knuckle joint	0.15	0.23	0.26	0.26	0.60	0.83	1.08
	Double knuckle joint (with pin)	0.22	0.37	0.43	0.43	0.87	1.27	1.58

Calculation

Example) **MBWB32-100Z** (Basic, ø32, 100 stroke)

- Basic weight..... 0.56 (Basic, ø32)
- Additional weight..... 0.15/50 stroke
- Cylinder stroke..... 100 stroke

$$0.56 + 0.15 \times 100/50 = \mathbf{0.86 \text{ kg}}$$

Construction

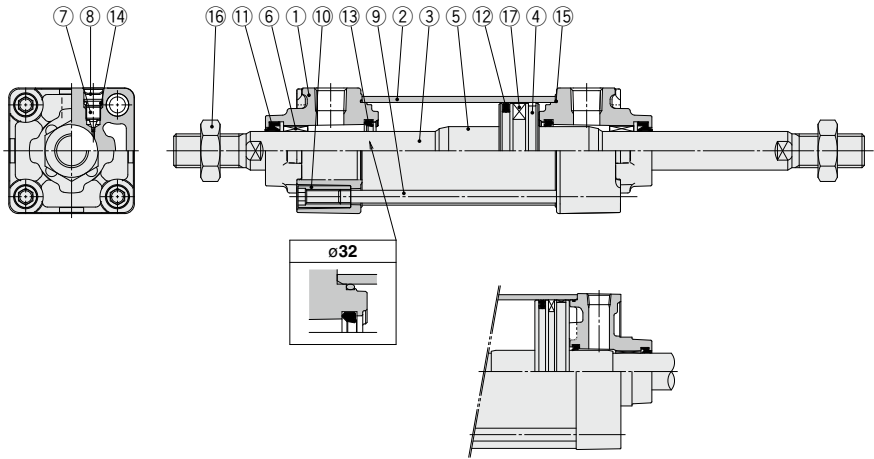

MBW125

Component Parts

No.	Description	Material	Qty	Note
1	Rod cover	Aluminum die-cast	2	Trivalent chromated
2	Cylinder tube	Aluminum alloy	1	Hard anodized
3	Piston rod	Carbon steel	1	Hard chrome plating
4	Piston	Aluminum alloy	1	
5	Cushion ring	Aluminum alloy	2	Anodized
6	Bushing	Bearing alloy	2	
7	Cushion valve	Steel wire	2	Trivalent zinc chromated
8	Retaining ring	Steel for spring	2	ø40 to ø125
9	Tie-rod	Carbon steel	4	Trivalent zinc chromated

No.	Description	Material	Qty	Note
10	Tie-rod nut	Carbon steel	8	Trivalent zinc chromated
11	Rod seal	NBR	2	
12	Piston seal	NBR	1	
13	Cushion seal	Urethane	2	
14	Cushion valve seal	NBR	2	
15	Cylinder tube gasket	NBR	2	
16	Rod end nut	Rolled steel	2	Trivalent zinc chromated
17	Magnet	—	(1)	

Replacement Parts/Seal Kit

Bore size [mm]	Kit no.	Contents
32	MBW32Z-PS	Set of the nos. ①, ⑫, ⑬, ⑮
40	CA2W40Z-PS	
50	CA2W50Z-PS	
63	CA2W63Z-PS	
80	CA2W80Z-PS	
100	CA2W100Z-PS	
125	MBW125-PS	

- * Seal kits consist of items ①, ⑫, ⑬, ⑮, and can be ordered by using the seal kit number corresponding to each bore size.
 - * Trunnion type should not be disassembled. (Refer to page 524.)
 - * The seal kit includes a grease pack (10 g for ø32 to ø50, 20 g for ø63 and ø80, 30 g for ø100 and ø125).
- Order with the following part number when only the grease pack is needed.
Grease pack part number: GR-S-010 (10 g), **GR-S-020** (20 g)

MBW Series

Standard

Basic: (B)

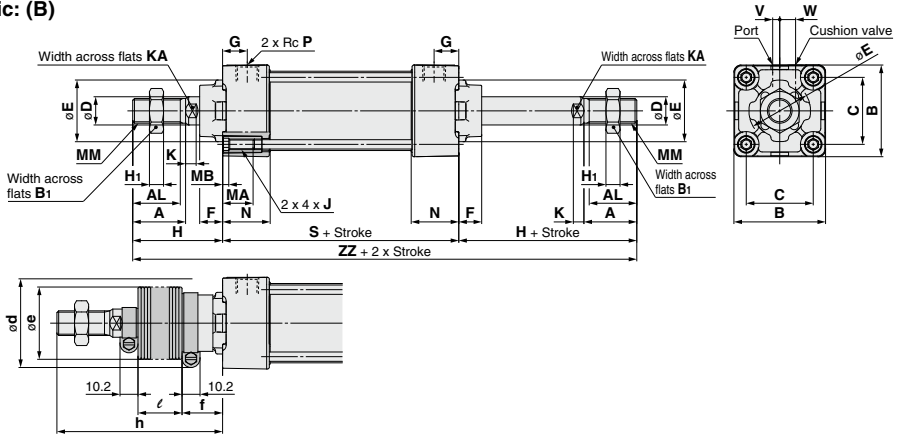

With rod boot

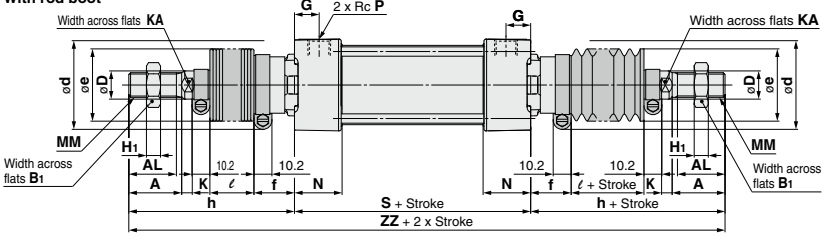

Rubber Bumper

Bore size [mm]	S	ZZ
32	90	184
40	90	192
50	102	218
63	102	218
80	124	268
100	124	268
125	132	326

Bore size [mm]	A	AL	B	B ₁	C	D	E	F	G	H	H ₁	J	K	KA	MA	MB	MM	N	P	S	V	W	ZZ
32	22	19.5	46	17	32.5	12	30	13	13	47	6	M6 x 1	6	10	16	4	M10 x 1.25	27	1/8	84	4	6.5	178
40	30	27	52	22	38	16	35	13	14	51	8	M6 x 1	6	14	16	4	M14 x 1.5	27	1/4	84	4	9	186
50	35	32	65	27	46.5	20	40	14	15.5	58	11	M8 x 1.25	7	18	16	5	M18 x 1.5	31.5	1/4	94	5	10.5	210
63	35	32	75	27	56.5	20	45	14	16.5	58	11	M8 x 1.25	7	18	16	5	M18 x 1.5	31.5	3/8	94	9	12	210
80	40	37	95	32	72	25	45	20	19	72	13	M10 x 1.5	10	22	16	5	M22 x 1.5	38	3/8	114	11.5	14	258
100	40	37	114	41	89	30	55	20	19	72	16	M10 x 1.5	10	26	16	5	M26 x 1.5	38	1/2	114	17	15	258
125	54	50	136	41	110	32	60	27	19	97	16	M12 x 1.75	13	27	20	6	M27 x 2.0	38	1/2	120	17	15	314

With Rod Boot

Bore size [mm]	d	e	f	c																h															
				1 to 50	51 to 100	101 to 150	151 to 200	201 to 300	301 to 400	401 to 500	501 to 600	601 to 700	701 to 800	801 to 900	901 to 1000	1 to 50	51 to 100	101 to 150	151 to 200	201 to 300	301 to 400	401 to 500	501 to 600	601 to 700	701 to 800	801 to 900	901 to 1000								
32	54	36	23	12.5	25	37.5	50	75	100	125	150	175	200	225	250	70	86	98	111	136	161	186	211	236	261	286	311								
40	56	41	23	12.5	25	37.5	50	75	100	125	150	175	200	225	250	81	94	106	119	144	169	194	219	244	269	294	319								
50	64	51	25	12.5	25	37.5	50	75	100	125	150	175	200	225	250	89	102	114	127	152	177	202	227	252	277	302	327								
63	64	51	25	12.5	25	37.5	50	75	100	125	150	175	200	225	250	89	102	114	127	152	177	202	227	252	277	302	327								
80	68	56	29	12.5	25	37.5	50	75	100	125	150	175	200	225	250	101	114	126	139	164	189	214	239	264	289	314	339								
100	76	61	29	12.5	25	37.5	50	75	100	125	150	175	200	225	250	101	114	126	139	164	189	214	239	264	289	314	339								
125	82	75	27	10	20	30	40	60	80	100	120	140	160	180	200	120	130	140	150	170	190	210	230	250	270	290	310								

Note) ZZ indicates dimensions for double side rod boot. [mm]

Bore size [mm]	ZZ (Note)											
	1 to 50	51 to 100	101 to 150	151 to 200	201 to 300	301 to 400	401 to 500	501 to 600	601 to 700	701 to 800	801 to 900	901 to 1000
32	230	256	280	306	356	406	456	506	556	606	656	706
40	246	272	296	322	372	422	472	522	572	622	672	722
50	272	298	322	348	398	448	498	548	598	648	698	748
63	272	298	322	348	398	448	498	548	598	648	698	748
80	316	342	366	392	442	492	542	592	642	692	742	792
100	316	342	366	392	442	492	542	592	642	692	742	792
125	360	380	400	420	460	500	540	580	620	660	700	740

* Model without air cushion is designed to include rubber bumpers. Since the bumpers are attached to the both sides of the piston, the overall length is longer than the cylinder with air cushion as follows: ø32, ø40: +6 mm, ø50, ø63: +8 mm, ø80, ø100: +10 mm, ø125: +12 mm

Standard/With Mounting Bracket

* Refer to Basic (B) for other dimensions and with rod boot.

Axial foot: (L)

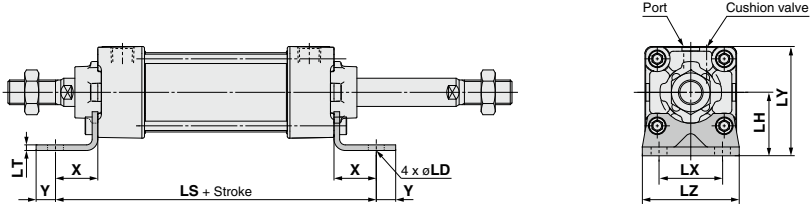

[mm]									
Bore size [mm]	X	Y	LD	LH	LS*	LT	LX	LY	LZ
32	22	9	7	30	128	3.2	32	53	50
40	24	11	9	33	132	3.2	38	59	55
50	27	11	9	40	148	3.2	46	72.5	70
63	27	14	12	45	148	3.6	56	82.5	80
80	30	14	12	55	174	4.5	72	102.5	100
100	32	16	14	65	178	4.5	89	122	120
125	45	20	14	81	210	8	90	149	136

Rod flange: (F)

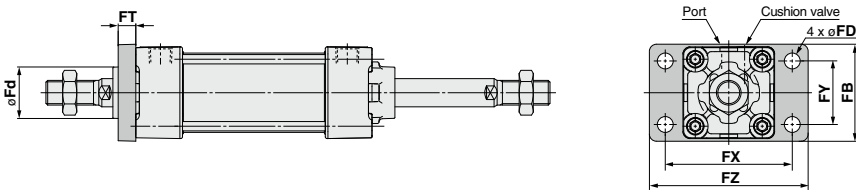

[mm]							
Bore size [mm]	FB	FD	FT	FX	FY	FZ	Fd
32	50	7	10	64	32	79	24.5
40	55	9	10	72	36	90	29.5
50	70	9	12	90	45	110	35.5
63	80	9	12	100	50	120	38.5
80	100	12	16	126	63	153	41
100	120	14	16	150	75	178	46
125	138	14	20	180	102	216	57

Center trunnion: (T)

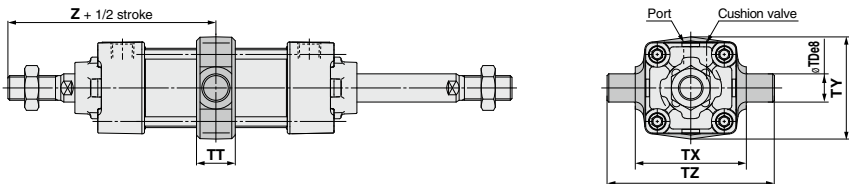

[mm]							
Bore size [mm]	TDe8	TT	TX	TY	TZ	Z**	
32	12	17	50	49	74	89	
40	16	22	63	58	95	93	
50	16	22	75	71	107	105	
63	20	28	90	87	130	105	
80	20	34	110	110	150	129	
100	25	40	132	136	182	129	
125	25	50	160	160	210	157	

* Model without air cushion is designed to include rubber bumpers. Since the bumpers are attached to the both sides of the piston, the overall length is longer than the cylinder with air cushion as follows: ø32, ø40: +6 mm, ø50, ø63: +8 mm, ø80, ø100: +10 mm, ø125: +12 mm

** Model without air cushion is designed to include rubber bumpers. Since the bumpers are attached to the both sides of the piston, the "Z" dimension is longer than the cylinder with air cushion as follows: ø32, ø40: +3 mm, ø50, ø63: +4 mm, ø80, ø100: +5 mm, ø125: +6 mm (For trunnion mounting)

Air Cylinder: Non-rotating Rod Type Double Acting, Single Rod

MBK Series

ø32, ø40, ø50, ø63, ø80, ø100



How to Order



MBK B 32 - 50 Z - - -

With auto switch MDBK B 32 - 50 Z - - - M9BW - - -

With auto switch (Built-in magnet)

Mounting type

B	Basic/Without bracket
L	Axial foot
F	Rod flange
G	Head flange
C	Single clevis
D	Double clevis
T	Center trunnion

* Mounting brackets other than trunnion type are shipped together.

Port thread type

Nil	Rc
TN	NPT
TF	G

Bore size

32	32 mm
40	40 mm
50	50 mm
63	63 mm
80	80 mm
100	100 mm

Cylinder stroke [mm]
Refer to "Standard Strokes" on page 499.

Accessories 1

Nil	No bracket
N	Pivot bracket

* Only for D and T mounting types.
* Pivot bracket is shipped together with the product.
* For details, refer to page 490.

Suffix (Cushion)

Nil	Air cushion
N*	Rubber bumper

* Since the bumpers are attached to the both sides of the piston for rubber bumper type, the overall length is longer than the cylinder with air cushion as follows: ø32, ø40: +6 mm, ø50, ø63: +8 mm, ø80, ø100: +10 mm.

Suffix (Rod boot)

Nil	None
J	Nylon tarpaulin
K	Heat resistant tarpaulin

Auto switch

Nil	Without auto switch
-----	---------------------

* For applicable auto switches, refer to the table below.

Number of auto switches

Nil	2 pcs.
S	1 pc.
3	3 pcs.
n	"n" pcs.

Made to Order
For details, refer to page 499.

Accessories 2

Nil	No bracket
V	Single knuckle joint
W	Double knuckle joint

* A knuckle joint pin is not provided with the single knuckle joint.
* Rod end bracket is shipped together with the product.
* The screw-in amount of the piston rod end cannot be adjusted when a clevis bracket, trunnion bracket and knuckle joint are used together.

Applicable Auto Switches/Refer to pages 1271 to 1365 for further information on auto switches.

Type	Special function	Electrical entry	Indication light	Wiring (Output)	Load voltage		Auto switch model		Lead wire length [m]				Pre-wired connector	Applicable load				
					DC	AC	Tie-rod mounting	Band mounting	0.5 (Nil)	1 (M)	3 (L)	5 (Z)						
Solid state auto switch	—	Grommet	—	3-wire (NPN)	24 V	5 V, 12 V	—	M9N	●	●	●	○	○	IC circuit	Relay, PLC			
				3-wire (PNP)				M9P	●	●	●	○	○					
		2-wire	M9B	●				●	●	○	○							
		—	G39	—				—	—	—	—							
	Diagnostic indication (2-color indicator)	Terminal conduit	Yes	3-wire (NPN)	24 V	5 V, 12 V	—	M9NW	●	●	●	○	○	IC circuit				
				3-wire (PNP)				M9PW	●	●	●	○	○					
	Water resistant (2-color indicator)	Grommet	—	2-wire	24 V	5 V, 12 V	—	M9B	●	●	●	○	○	—				
				3-wire (NPN)				M9NA ^{*1}	—	○	○	●	○			○		
	Diagnostic output (2-color indicator)	—	—	—	24 V	5 V, 12 V	—	M9PA ^{*1}	—	○	○	●	○	IC circuit				
								3-wire (PNP)	M9BA ^{*1}	—	○	○	○			○	○	
Magnetic field resistant (2-color indicator)	—	—	—	24 V	5 V, 12 V	—	F59F	—	●	—	●	○	IC circuit					
							2-wire (Non-polar)	P3DWA	—	●	—	●		○	○			
Reed auto switch	—	Grommet	Yes	3-wire (Equiv. to NPN)	24 V	5 V	—	A96	—	●	—	●	—	IC circuit	Relay, PLC			
				—				A93	—	●	—	●	—			—		
				—				A90	—	●	—	●	—			—		
				—				A54	—	●	—	●	—			—		
				—				A64	—	●	—	●	—			—		
		Terminal conduit	No	—	—	24 V	12 V	—	—	A33	—	—	—	—		—		
									—	A34	—	—	—	—			—	
									—	A44	—	—	—	—			—	—
									—	—	—	—	—	—			—	—
									—	A59W	—	●	—	●			—	—
DIN terminal	Yes	—	—	24 V	12 V	—	—	—	—	—	—	—	—					
							—	—	—	—	—	—		—				
							—	—	—	—	—	—		—	—			
							—	—	—	—	—	—		—	—			
							—	—	—	—	—	—		—	—			
Grommet	No	—	—	24 V	12 V	—	—	A59W	—	●	—	●	—					

*1 Water resistant type auto switches can be mounted on the above models, but in such case SMC cannot guarantee water resistance.

A water resistant type cylinder is recommended for use in an environment which requires water resistance.

* Lead wire length symbols: 0.5 m Nil (Example) M9NW 3 m L (Example) M9NWL 1 m M (Example) M9NWM 5 m Z (Example) M9NWZ

* Solid state auto switches marked with "○" are produced upon receipt of order.

* Since there are other applicable auto switches than listed above, refer to page 522 for details.

* The D-A9□/M9□/P3DWA□ auto switches are shipped together, (but not assembled). (However, auto switch mounting brackets are assembled for the D-A9□/M9□ before shipment.)

Specifications

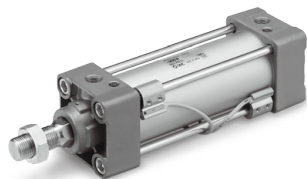

Symbol

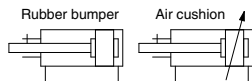

Bore size [mm]	32	40	50	63	80	100
Action	Double acting, Single rod					
Fluid	Air					
Proof pressure	1.5 MPa					
Maximum operating pressure	1.0 MPa					
Minimum operating pressure	0.05 MPa					
Ambient and fluid temperature	Without auto switch: -10 to 70°C With auto switch: -10 to 60°C (No freezing)					
Lubricant	Non-lube					
Piston speed	50 to 1000 mm/s					
Stroke length tolerance	Up to 250: $^{+1.0}_0$, 251 to 1000: $^{+1.4}_0$, 1001 to 1500: $^{+1.8}_0$					
Cushion <small>Note)</small>	Air cushion or Rubber bumper					
Port size (Rc, NPT, G)	1/8	1/4	3/8	1/2		
Mounting	Basic, Axial foot, Rod flange, Head flange, Single clevis, Double clevis, Center trunnion					
Non-rotating accuracy	$\pm 0.5^\circ$		$\pm 0.5^\circ$		$\pm 0.3^\circ$	
Allowable rotating torque N-m or less	0.25	0.45	0.64	0.79	0.93	

Note) Kinetic energy absorbable by the cushion mechanism is identical to double acting single rod.



Made to Order

[Click here for details](#)

Symbol	Specifications
-XA□	Change of rod end shape
-XC3	Special port location*
-XC7	Tie-rod, cushion valve, tie-rod nut, etc. made of stainless steel
-XC8	Adjustable stroke cylinder/Adjustable extension type
-XC9	Adjustable stroke cylinder/Adjustable retraction type
-XC10	Dual stroke cylinder/Double rod type
-XC14	Change of trunnion bracket mounting position
-XC27	Double clevis and double knuckle joint pins made of stainless steel
-XC30	Rod trunnion

* The cover shape is the same as the current product.

For special port location (-XC3), the mounting bracket and port location can be determined using the standard product corresponding to the operating conditions. Also, this is only applicable to -XC3BB, -XC3CC and -XC3DD with trunnion bracket.

Refer to pages 515 to 522 for cylinders with auto switches.

- Auto switch proper mounting position (detection at stroke end) and its mounting height
- Minimum stroke for auto switch mounting
- Auto switch mounting brackets/Part no.
- Operating range

Standard Strokes

Bore size	Standard stroke [mm]
32	25, 50, 75, 100, 125, 150, 175, 200, 250, 300, 350, 400, 450, 500
40	25, 50, 75, 100, 125, 150, 175, 200, 250, 300, 350, 400, 450, 500
50	25, 50, 75, 100, 125, 150, 175, 200, 250, 300, 350, 400, 450, 500, 600
63	25, 50, 75, 100, 125, 150, 175, 200, 250, 300, 350, 400, 450, 500, 600
80	25, 50, 75, 100, 125, 150, 175, 200, 250, 300, 350, 400, 450, 500, 600, 800
100	25, 50, 75, 100, 125, 150, 175, 200, 250, 300, 350, 400, 450, 500, 600, 800

Note 1) Manufacture of intermediate strokes is possible. (Spacers are not used.)

Note 2) Using a stroke of a length which is smaller than the effective cushion length may result in reduced air cushion performance. Refer to "Technical Data 1" on page 1573 for details on the effective cushion length.

Accessories

Mounting		Basic	Axial foot	Rod flange	Head flange	Single clevis	Double clevis	Center trunnion
Standard	Rod end nut	●	●	●	●	●	●	●
	Clevis pin	—	—	—	—	—	●	—
Option	Single knuckle joint	●	●	●	●	●	●	●
	Double knuckle joint (with pin)	●	●	●	●	●	●	●
	Rod boot	●	●	●	●	●	●	●

* Refer to page 491 for dimensions and part numbers. (Refer to page 486 for rod boot.)

Rod Boot Material

Symbol	Material	Max. ambient temp.
J	Nylon tarpaulin	70°C
K	Heat resistant tarpaulin	110°C*

* Max. ambient temperature for rod boot itself.

MBK Series

Mounting Brackets/Part No.

Bore size [mm]	32	40	50	63	80	100
Axial foot ^{Note 1)}	MB-L03	MB-L04	MB-L05	MB-L06	MB-L08	MB-L10
Rod/Head flange	MB-F03	MB-F04	MB-F05	MB-F06	MB-F08	MB-F10
Single clevis	MB-C03	MB-C04	MB-C05	MB-C06	MB-C08	MB-C10
Double clevis	MB-D03	MB-D04	MB-D05	MB-D06	MB-D08	MB-D10

Note 1) Order two foots per cylinder.

Note 2) Accessories for each mounting bracket are as follows. Axial foot, Rod/Head flange, Single clevis/Body mounting bolt; Double clevis/Body mounting bolt, Clevis pin, Flat washers and Split pins. → Refer to page 491 for details.

Theoretical Force

OUT side is identical to double acting single rod. Refer to the table below for IN side.

Bore size [mm]	Piston area [mm ²]
32	675
40	1082
50	1651
63	2804
80	4568
100	7223

Theoretical force [N] = Pressure [MPa] x Piston area [mm²]

Weights

Bore size [mm]		32	40	50	63	80	100
Basic weight	Basic	0.47	0.64	1.11	1.35	2.54	3.52
	Axial foot	0.59	0.78	1.33	1.63	3.04	4.19
	Rod/Head flange	0.76	1.01	1.56	2.14	3.99	5.35
	Single clevis	0.72	0.87	1.45	1.98	3.65	5.10
	Double clevis	0.73	0.91	1.54	2.14	3.94	5.37
	Center trunnion	0.76	1.00	1.59	2.15	4.09	5.21
Additional weight per 50 mm of stroke	All mounting brackets	0.12	0.15	0.24	0.26	0.39	0.50
Accessories	Single knuckle joint	0.15	0.23	0.26	0.26	0.60	0.83
	Double knuckle joint (with pin)	0.22	0.37	0.43	0.43	0.87	1.27

Calculation

Example) **MBK32-100Z** (Basic, ø32, 100 stroke)

- Basic weight..... 0.47 (Basic, ø32)
- Additional weight..... 0.12/50 stroke
- Cylinder stroke..... 100 stroke

$$0.47 + 0.12 \times 100/50 = 0.71 \text{ kg}$$

Construction

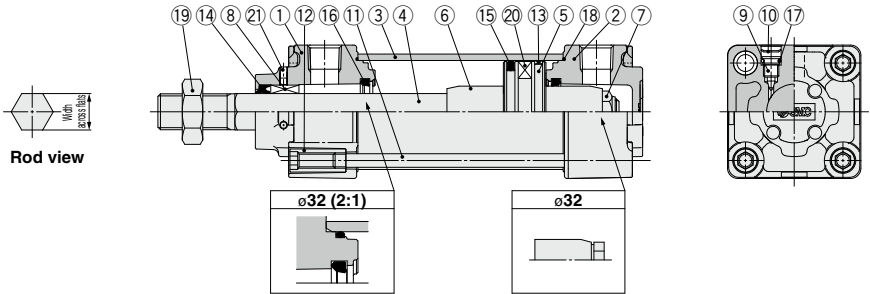

Component Parts

No.	Description	Material	Q'ty	Note
1	Rod cover	Aluminum die-casted	1	Trivalent chromated
2	Head cover	Aluminum die-casted	1	Trivalent chromated
3	Cylinder tube	Aluminum alloy	1	Hard anodized
4	Piston rod	Stainless steel	1	
5	Piston	Aluminum alloy	1	
6	Cushion ring	Rolled steel	2	Zinc chromated
7	Piston nut	Rolled steel	1	Zinc chromated
8	Non-rotating guide	Bearing alloy	1	
9	Cushion valve	Steel wire	2	Trivalent zinc chromated
10	Retaining ring	Spring steel	2	ø40 to ø100
11	Tie-rod	Carbon steel	4	Trivalent zinc chromated

No.	Description	Material	Q'ty	Note
12	Tie-rod nut	Carbon steel	8	Trivalent zinc chromated
13	Wear ring	Resin	1	
14 ¹⁾	Rod seal	NBR	1	
15 ¹⁾	Piston seal	NBR	1	
16 ¹⁾	Cushion seal	Urethane	2	
17	Cushion valve seal	NBR	2	
18 ¹⁾	Cylinder tube gasket	NBR	2	
19	Rod end nut	Rolled steel	1	Trivalent zinc chromated
20	Magnet	—	(1)	
21	Hexagon socket head set screw	Steel wire	2	Trivalent black zinc chromated

Replacement Parts/Seal Kit

Bore size [mm]	Kit no.	Contents
32	MBK32Z-PS	Set of the nos. 14, 15, 16, 18
40	MBK40Z-PS	
50	MBK50Z-PS	
63	MBK63Z-PS	
80	MBK80Z-PS	
100	MBK100Z-PS	

* Seal kits consist of items 14, 15, 16, 18, and can be ordered by using the seal kit number corresponding to each bore size.
 * Seal kit includes a grease pack (ø32 to 50: 10 g, ø63, 80: 20 g, ø100: 30 g).
 Order with the following part number when only the grease pack is needed.
Grease pack part number: GR-S-010 (10 g), GR-S-020 (20 g)

¹⁾ Model without air cushion is designed to include rubber bumpers. The overall length is longer than the cylinder with air cushion as follows because the bumpers are attached to the both sides of the piston;
 ø32, ø40: +6 mm, ø50, ø63: +8 mm, ø80, ø100: +10 mm

Without Mounting Bracket

Basic: (B)

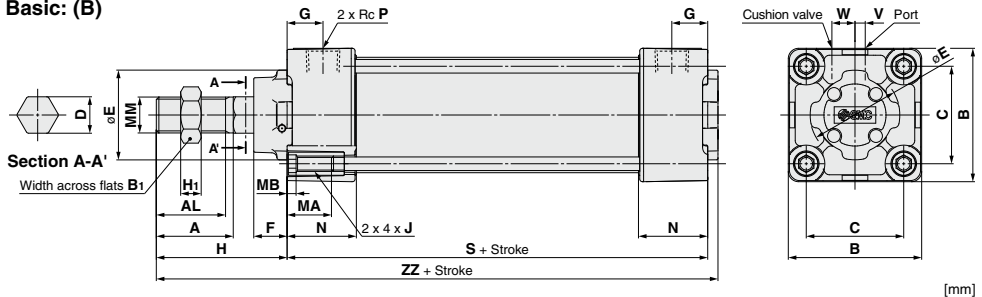

Bore size [mm]	A	AL	B	B ₁	C	D	E	F	G	H	H ₁	J	MA	MB	MM	N	P	S	V	W	ZZ
32	22	19.5	46	17	32.5	12.2	30	13	13	47	6	M6 x 1	16	4	M10 x 1.25	27	1/8	84	4	6.5	135
40	30	27	52	22	38	14.2	35	13	14	51	8	M6 x 1	16	4	M14 x 1.5	27	1/4	84	4	9	139
50	35	32	65	27	46.5	19	40	14	15.5	58	11	M8 x 1.25	16	5	M18 x 1.5	31.5	1/4	94	5	10.5	156
63	35	32	75	27	56.5	19	45	14	16.5	58	11	M8 x 1.25	16	5	M18 x 1.5	31.5	3/8	94	9	12	156
80	40	37	95	32	72	23	45	20	19	72	13	M10 x 1.5	16	5	M22 x 1.5	38	3/8	114	11.5	14	190
100	40	37	114	41	89	27	55	20	19	72	16	M10 x 1.5	16	5	M26 x 1.5	38	1/2	114	17	15	190

The dimensions for each mounting type and the dimensions with rod boot are the same as those for standard model (double acting, single rod).

Air Cylinder: Non-rotating Rod Type Double Acting, Double Rod

MBKW Series



ø32, ø40, ø50, ø63, ø80, ø100

How to Order



MBKW L 32 [] - 150 [] [] Z - []

With auto switch **MDBKW L 32 [] - 150 [] [] Z - M9BW [] - []**

Mounting type

B	Basic/Without bracket
L	Axial foot
F	Rod flange
T	Center trunnion

* Mounting brackets other than trunnion type are shipped together.

Bore size

32	32 mm
40	40 mm
50	50 mm
63	63 mm
80	80 mm
100	100 mm

Port thread type

Nil	Rc
TN	NPT
TF	G

Cylinder stroke [mm]

Refer to "Standard Strokes" on page 503.

Auto switch

Nil	Without auto switch
-----	---------------------

* For applicable auto switches, refer to the table below.

Number of auto switches

Nil	2 pcs.
S	1 pc.
3	3 pcs.
n	"n" pcs.

Made to Order

For details, refer to page 503.

Suffix (Cushion)

Nil	Air cushion
N*	Rubber bumper

* Since the bumpers are attached to the both sides of the piston for rubber bumper type, the overall length is longer than the cylinder with air cushion as follows: ø32, ø40: +6 mm, ø50, ø63: +8 mm, ø80, ø100: +10 mm.

Suffix (Rod boot)

Nil	None
J	Nylon tarpaulin (one end)
JJ	Nylon tarpaulin (both ends)
K	Heat resistant tarpaulin (one end)
KK	Heat resistant tarpaulin (both ends)

Applicable Auto Switches/Refer to pages 1271 to 1365 for further information on auto switches.

Type	Special function	Electrical entry	Indicator light	Wiring (Output)	Load voltage		Auto switch model		Lead wire length [m]			Pre-wired connector	Applicable load						
					DC	AC	Tie-rod mounting	Band mounting	0.5 (Nil)	1 (M)	3 (L)			5 (Z)					
Solid state auto switch	—	Grommet	—	3-wire (NPN)	24 V	5 V, 12 V	—	M9N	●	●	●	○	IC circuit	Relay, PLC					
				3-wire (PNP)				M9P	●	●	●	○							
		2-wire		M9B	●	●	●	○											
		Terminal conduit		3-wire (NPN)	24 V	5 V, 12 V	—	G39	—	—	—	—			—				
				2-wire				K39	—	—	—	—							
		Diagnostic indication (2-color indicator)		Grommet	Yes	—	3-wire (NPN)	24 V	5 V, 12 V	—	M9NW	●			●	●	○	IC circuit	
	3-wire (PNP)		M9PW				●				●	●	○						
	Water resistant (2-color indicator)	Grommet	—	—	2-wire	24 V	5 V, 12 V	—	M9BW	●	●	●	○		—				
					3-wire (NPN)				M9NA*1	—	○	○	●			○	IC circuit		
	Diagnostic output (2-color indicator)	Grommet	—	—	3-wire (PNP)	24 V	5 V, 12 V	—	M9PA*1	—	○	○	●		IC circuit				
					2-wire				M9BA*1	—	○	○	●			○			
	Magnetic field resistant (2-color indicator)	Grommet	—	—	4-wire (NPN)	24 V	5 V, 12 V	—	F59F	—	●	—	○		IC circuit				
2-wire (Non-polar)					P3DWA				—	●	—	●	○	—					
Reed auto switch	—	Grommet	—	3-wire (Equiv. to NPN)	24 V	12 V	—	A96	—	●	—	●	IC circuit		Relay, PLC				
				Yes				No	2-wire	100 V	A93	—		●		—	●	—	IC circuit
										100 V or less	A90	—		●		—	●	—	
										100 V, 200 V	A54	—		●		—	●	—	
										200 V or less	A64	—		●		—	●	—	
		No		Yes	Terminal conduit	2-wire	—	24 V	12 V	—	A33	—	—	—		—	—		
							—				A34	—	—	—		—			
							—				A44	—	—	—		—			
							100 V, 200 V				—	—	—	—		—			
							—				A59W	—	●	—		●		—	

*1 Water resistant type auto switches can be mounted on the above models, but in such case SMC cannot guarantee water resistance.

* Lead wire length symbols: 0.5 m Nil (Example) M9NW 3 m L (Example) M9NWL
1 m M (Example) M9NWM 5 m Z (Example) M9NWZ

* Solid state auto switches marked with "○" are produced upon receipt of order.

* Since there are other applicable auto switches than listed above, refer to page 522 for details.

* The D-A9□/M9□/P3DWA□ auto switches are shipped together, (but not assembled). (However, auto switch mounting brackets are assembled for the D-A9□/M9□ before shipment.)

Air Cylinder: Non-rotating Rod Type **MBKW Series**

Specifications

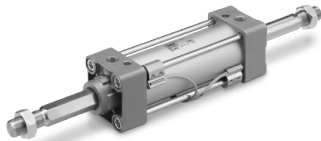

Symbol

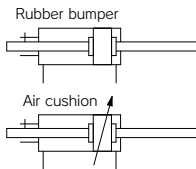

Bore size [mm]	32	40	50	63	80	100
Action	Double acting, Double rod					
Fluid	Air					
Proof pressure	1.5 MPa					
Max. operating pressure	1.0 MPa					
Min. operating pressure	0.05 MPa					
Ambient and fluid temperature	Without auto switch: -10 to 70°C With auto switch: -10 to 60°C (No freezing)					
Lubrication	Non-lube					
Operating piston speed	50 to 1000 mm/s					
Allowable stroke tolerance	Up to 250: $^{+1.0}_0$, 251 to 800: $^{+1.4}_0$					
Cushion ^{Note)}	Air cushion or Rubber bumper					
Port size (Rc, NPT, G)	1/8	1/4	3/8	1/2		
Mounting	Basic, Axial foot, Rod flange, Center trunnion					
Non-rotating accuracy	$\pm 0.5^\circ$ $\pm 0.5^\circ$ $\pm 0.3^\circ$					
Allowable rotating torque N-m or less	0.25	0.45	0.64	0.79	0.93	

Note) Kinetic energy absorbable by cushion mechanism is identical to double acting single rod.



Made to Order
[Click here for details](#)

Symbol	Specifications
-XC3	Special port location*
-XC7	Tie-rod, cushion valve, tie-rod nut, etc. made of stainless steel

* The cover shape is the same as the current product.

For special port location (-XC3), the mounting bracket and port location can be determined using the standard product corresponding to the operating conditions. Also, this is only applicable to -XC3BB, -XC3CC and -XC3DD with trunnion bracket.

Standard Strokes

Bore size	Standard stroke [mm]
32	25, 50, 75, 100, 125, 150, 175, 200, 250, 300, 350, 400, 450, 500
40	25, 50, 75, 100, 125, 150, 175, 200, 250, 300, 350, 400, 450, 500
50	25, 50, 75, 100, 125, 150, 175, 200, 250, 300, 350, 400, 450, 500, 600
63	25, 50, 75, 100, 125, 150, 175, 200, 250, 300, 350, 400, 450, 500, 600
80	25, 50, 75, 100, 125, 150, 175, 200, 250, 300, 350, 400, 450, 500, 600, 800
100	25, 50, 75, 100, 125, 150, 175, 200, 250, 300, 350, 400, 450, 500, 600, 800

Note 1) Manufacture of intermediate strokes is possible. (Spacers are not used.)

Note 2) Using a stroke of a length which is smaller than the effective cushion length may result in reduced air cushion performance. Refer to "Technical Data 1" on page 1573 for details on the effective cushion length.

Accessories

Mounting		Basic	Axial foot	Rod flange	Center trunnion
Standard	Rod end nut	●	●	●	●
	Single knuckle joint	●	●	●	●
Option	Double knuckle joint (with pin)	●	●	●	●
	Rod boot	●	●	●	●

* Refer to page 491 for dimensions and part numbers. (Except rod boot)

Rod Boot Material

Symbol	Material	Max. ambient temp.
J	Nylon tarpaulin	70°C
K	Heat resistant tarpaulin	110°C*

* Max. ambient temperature for rod boot itself.

Mounting Brackets/Part No.

Bore size [mm]	32	40	50	63	80	100
Axial foot	MB-L03	MB-L04	MB-L05	MB-L06	MB-L08	MB-L10
Rod flange	MB-F03	MB-F04	MB-F05	MB-F06	MB-F08	MB-F10

Note) Order two feet per cylinder.

Refer to pages 515 to 522 for cylinders with auto switches.

- Auto switch proper mounting position (detection at stroke end) and its mounting height
- Minimum stroke for auto switch mounting
- Auto switch mounting brackets/Part no.
- Operating range

MBKW Series

Theoretical Force



Bore size [mm]	Rod dia. [mm] Width across flats [mm]	Operating direction	Piston area [mm ²]	Operating pressure [MPa]								
				0.2	0.3	0.4	0.5	0.6	0.7	0.8	0.9	1.0
32	12	OUT	691	138	207	276	346	415	484	553	622	691
	12.2	IN	675	135	203	270	338	405	473	540	608	675
40	16	OUT	1056	211	317	422	528	634	739	845	950	1056
	14.2	IN	1082	216	325	433	541	649	757	866	974	1082
50	20	OUT	1649	330	495	660	825	989	1154	1319	1484	1649
	19	IN	1651	330	495	660	826	991	1156	1321	1486	1651
63	20	OUT	2803	561	841	1121	1402	1682	1962	2242	2523	2803
	19	IN	2804	561	841	1122	1402	1682	1963	2243	2524	2804
80	25	OUT	4536	907	1361	1814	2268	2722	3175	3629	4082	4536
	23	IN	4568	914	1370	1827	2284	2741	3198	3654	4111	4568
100	30	OUT	7147	1429	2144	2859	3574	4288	5003	5718	6432	7147
	27	IN	7223	1445	2167	2889	3612	4334	5056	5778	6501	7223

Note) Theoretical force [N] = Pressure [MPa] x Piston area [mm²]

Weights/Aluminum Tube

Bore size [mm]		32	40	50	63	80	100
Basic weight	Basic	0.56	0.77	1.34	1.60	2.99	4.10
	Axial foot	0.68	0.91	1.56	1.88	3.49	4.76
	Rod flange	0.85	1.14	1.79	2.39	4.44	5.93
	Center trunnion	0.85	1.13	1.82	2.40	4.54	5.79
Additional weight per 50 mm of stroke	All mounting brackets	0.16	0.23	0.37	0.38	0.60	0.79
	Single knuckle joint	0.15	0.23	0.26	0.26	0.6	0.83
Accessories	Double knuckle joint (with pin)	0.22	0.37	0.43	0.43	0.87	1.27

[kg]

Calculation

Example) **MBKW32-100Z** (Basic, ø32, 100 st)

• Basic weight ...0.56 (Basic, ø32)

• Additional weight ...0.16/50 stroke

0.56 + 0.16 × 100/50 = **0.88 kg**

Construction

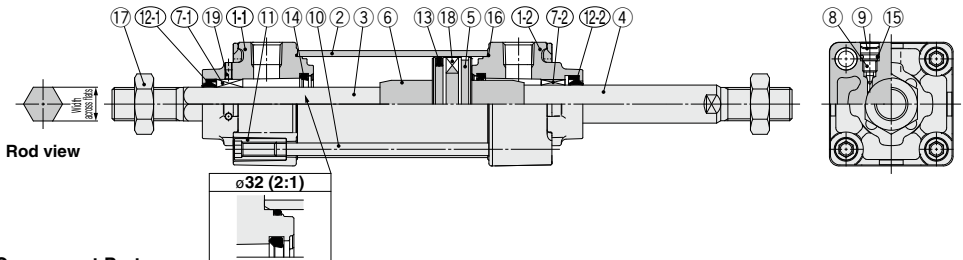

Component Parts

No.	Description	Material	Q'ty	Note
1-1	Rod cover	Aluminum die-casted	1	Non-rotating rod
1-2	Rod cover	Aluminum die-casted	1	Standard
2	Cylinder tube	Aluminum alloy	1	Hard anodized
3	Piston rod A	Stainless steel	1	Non-rotating rod
4	Piston rod B	Carbon steel	1	Standard
5	Piston	Aluminum alloy	1	
6	Cushion ring	Rolled steel	2	Zinc chromated
7-1	Non-rotating guide	Bearing alloy	1	Non-rotating rod
7-2	Bushing	Bearing alloy	1	Standard
8	Cushion valve	Steel wire	2	Trivalent zinc chromated
9	Retaining ring	Spring steel	2	ø40 to ø100
10	Tie-rod	Carbon steel	4	Trivalent zinc chromated
11	Tie-rod nut	Carbon steel	8	Trivalent zinc chromated
12-1*	Rod seal	NBR	1	Non-rotating rod
12-2*	Rod seal	NBR	1	Standard
13*	Piston seal	NBR	1	
14*	Cushion seal	Urethane	2	
15	Cushion valve seal	NBR	2	
16*	Cylinder tube gasket	NBR	2	

No.	Description	Material	Q'ty	Note
17	Rod end nut	Rolled steel	2	Trivalent zinc chromated
18	Magnet	—	(1)	
19	Hexagon socket head set screw	Steel wire	2	Trivalent black zinc chromated

Replacement Parts/Seal Kit

Bore size [mm]	Kit no.	Contents
32	MBKW32Z-PS	Set of the nos. 12, 13, 14, 16
40	MBKW40Z-PS	
50	MBKW50Z-PS	
63	MBKW63Z-PS	
80	MBKW80Z-PS	
100	MBKW100Z-PS	

* Seal kits consist of items 12, 13, 14, 16, and can be ordered by using the seal kit number corresponding to each bore size.

* Trunnion type should not be disassembled. (Refer to page 524.)

* Seal kit includes a grease pack (ø32 to 50: 10 g, ø63, 80: 20 g, ø100: 30 g). Order with the following part number when only the grease pack is needed.

Grease pack part number: GR-S-010 (10 g), GR-S-020 (20 g)

Standard

Basic: (B)

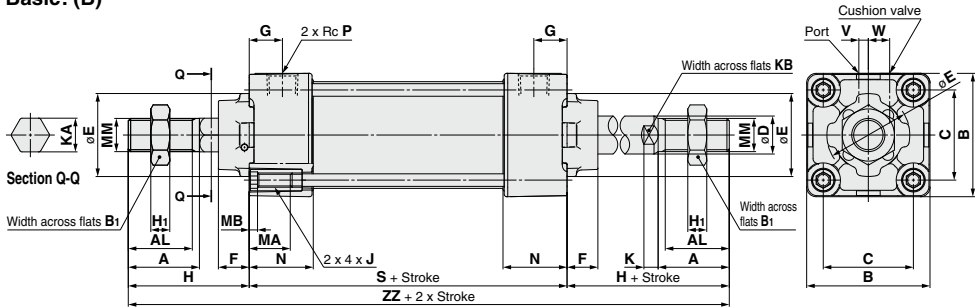

Positional relationship between port and cushion valve

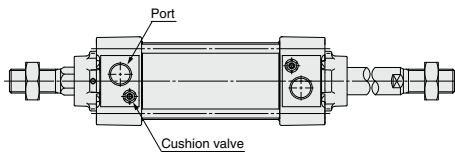

Bore size [mm]	[mm]														
	A	AL	B	B ₁	C	D	E	F	G	H	H ₁	J	K	KA	KB
32	22	19.5	46	17	32.5	12	30	13	13	47	6	M6 x 1	6	12.2	10
40	30	27	52	22	38	16	35	13	14	51	8	M6 x 1	6	14.2	14
50	35	32	65	27	46.5	20	40	14	15.5	58	11	M8 x 1.25	7	19	18
63	35	32	75	27	56.5	20	45	14	16.5	58	11	M8 x 1.25	7	19	18
80	40	37	95	32	72	25	45	20	19	72	13	M10 x 1.5	10	23	22
100	40	37	114	41	89	30	55	20	19	72	16	M10 x 1.5	10	27	26

Bore size [mm]	[mm]								
	MA	MB	MM	N	P	S*	V	W	ZZ*
32	16	4	M10 x 1.25	27	1/8	84	4	6.5	178
40	16	4	M14 x 1.5	27	1/4	84	4	9	186
50	16	5	M18 x 1.5	31.5	1/4	94	5	10.5	210
63	16	5	M18 x 1.5	31.5	3/8	94	9	12	210
80	16	5	M22 x 1.5	38	3/8	114	11.5	14	258
100	16	5	M26 x 1.5	38	1/2	114	17	15	258

* Model without air cushion is designed to include rubber bumpers. The overall length is longer than the cylinder with air cushion as follows because the bumpers are attached to the both sides of the piston; ø32, ø40: +6 mm, ø50, ø63: +8 mm, ø80, ø100: +10 mm

The dimensions for each mounting type are the same as those for standard model (double acting, double rod). Refer to pages 496 and 497.

Air Cylinder: With End Lock

MBB Series

∅32, ∅40, ∅50, ∅63, ∅80, ∅100



How to Order



MBB L 32 [] - 50 [] - H N - []

With auto switch

MDBB L 32 [] - 50 [] - H N - M9BW [] - []

With auto switch
(Built-in magnet)

Mounting type

B	Basic/Without bracket
L	Axial foot
F	Rod flange
G	Head flange
C	Single clevis
D	Double clevis
T	Center trunnion

Bore size

32	32 mm
40	40 mm
50	50 mm
63	63 mm
80	80 mm
100	100 mm

Port thread type

Nil	Rc
TN	NPT
TF	G

Cylinder stroke [mm]

Refer to "Standard Strokes" on page 507.

Manual release

N	Non-locking
L	Locking

Made to Order
For details, refer to page 507.

Number of auto switches

Nil	2 pcs.
S	1 pc.
3	3 pcs.
n	"n" pcs.

Locking position

H	Locking at head end
R	Locking at rod end
W	Locking at both ends

Suffix (Rod boot)

Nil	None
J	Nylon tarpaulin
K	Heat resistant tarpaulin

Auto switch

Nil	Without auto switch
-----	---------------------

* For applicable auto switches, refer to the table below.

Built-in Magnet Cylinder Model

If a built-in magnet cylinder without an auto switch is required, there is no need to enter the symbol for the auto switch. (Example) MDBBB40-100

Applicable Auto Switches/Refer to pages 1271 to 1365 for further information on auto switches.

Type	Special function	Electrical entry	Indicate light	Wiring (Output)	Load voltage		Auto switch model		Lead wire length [m]				Pre-wired connector	Applicable load									
					DC	AC	Tie-rod mounting	Band mounting	0.5 (Nil)	1 (M)	3 (L)	5 (Z)											
Solid state auto switch	—	Grommet	—	3-wire (NPN)	24 V	5 V, 12 V	—	M9N	●	●	●	○	○	IC circuit	Relay, PLC								
				3-wire (PNP)				12 V	M9P	●	●	●	○			○							
		Terminal conduit	—	2-wire	24 V	5 V, 12 V	—	M9B	●	●	●	○	○										
				3-wire (NPN)				12 V	G39	●	●	●	○			○							
		Diagnostic indication (2-color indicator)	Grommet	Yes	3-wire (NPN)	24 V	5 V, 12 V	—	M9NW	●	●	●	○			○	IC circuit						
	3-wire (PNP)				12 V				M9PW	●	●	●	○	○									
	Terminal conduit		—	2-wire	24 V	5 V, 12 V	—	M9BW	●	●	●	○	○	—									
				3-wire (NPN)				12 V	M9NA*1	—	○	○	●			○		○	IC circuit				
				3-wire (PNP)				12 V	M9PA*1	—	○	○	●			○		○					
	Diagnostic output (2-color indicator)	Grommet	—	2-wire	24 V	5 V, 12 V	—	M9BA*1	—	○	○	●	○	○		—							
4-wire (NPN)				12 V				F59F	—	●	—	●	○	○	IC circuit								
Magnetic field resistant (2-color indicator)	Terminal conduit	—	2-wire (Non-polar)	24 V	5 V, 12 V	—	P3DWA	—	●	—	●	●	○	—									
			2-wire (Non-polar)				—	P4DW	—	—	—	●	●		○								
Reed auto switch	—	Grommet	Yes	3-wire (Equiv. to NPN)	24 V	5 V	—	A96	—	●	—	●	—	IC circuit	—								
				Terminal conduit				—	2-wire	24 V	12 V	—	100 V			A93	—	●	●	●	—	IC circuit	
													100 V or less			A90	—	●	●	●	—		
													100 V, 200 V			A54	—	●	—	●	●		—
													200 V or less			A64	—	●	—	●	—		
		DIN terminal	Yes	—	2-wire	24 V	100 V, 200 V	—	—	A33	—	—	—	—		—							
									—	A34	—	—	—	—									
									—	A44	—	—	—	—									
									—	—	—	—	—	—									
									—	A59W	—	●	—	●			—						

*1 Water resistant type auto switches can be mounted on the above models, but in such case SMC cannot guarantee water resistance.

* Lead wire length symbols: 0.5 m Nil (Example) M9NW 3 m L (Example) M9NWL 1 m M (Example) M9NWM 5 m Z (Example) M9NwZ

* Solid state auto switches marked with "□" are produced upon receipt of order.

* Since there are other applicable auto switches than listed above, refer to page 522 for details.

* The D-A9□/M9□/P3DWA□A auto switches are shipped together, (but not assembled). (However, auto switch mounting brackets are assembled for the D-A9□/M9□ before shipment.)

Specifications

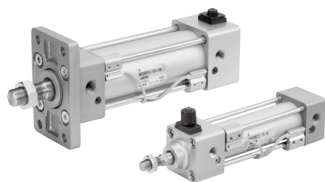

Symbol
Air cushion

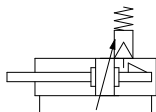

Bore size [mm]	32	40	50	63	80	100
Action	Double acting, Single rod					
Fluid	Air					
Proof pressure	1.5 MPa					
Max. operating pressure	1.0 MPa					
Min. operating pressure	0.15 MPa*					
Ambient and fluid temperature	Without auto switch: -10 to 70°C With auto switch: -10 to 60°C (No freezing)					
Lubrication	Non-lube					
Operating piston speed	50 to 1000 mm/s					
Allowable stroke tolerance	Up to 250: $^{+1.0}_0$, 251 to 1000: $^{+1.4}_0$, 1001 to 1500: $^{+1.8}_0$					
Cushion	Air cushion					
Port size (Rc, NPT, G)	1/8	1/4	3/8	1/2		
Mounting	Basic, Axial foot, Rod flange, Head flange, Single clevis, Double clevis, Center trunnion					

* 0.05 MPa except locking parts



Made to Order
[Click here for details](#)

Symbol	Specifications
-XA□	Change of rod end shape
-XC7	Tie-rod, cushion valve, tie-rod nut, etc. made of stainless steel
-XC10	Dual stroke cylinder/Double rod type
-XC14	Change of trunnion bracket mounting position
-XC27	Double clevis and double knuckle joint pins made of stainless steel
-XC29	Double knuckle joint with spring pin
-XC30	Rod trunnion

* All Made-to-Order products have the same cover shapes as the current products.

Refer to pages 515 to 522 for cylinders with auto switches.

- Auto switch proper mounting position (detection at stroke end) and its mounting height
- Minimum stroke for auto switch mounting
- Auto switch mounting brackets/Part no.
- Operating range

Locking Specifications

Locking position	Head end, Rod end, Both ends					
	ø32	ø40	ø50	ø63	ø80	ø100
Holding force (Max.) N	550	860	1340	2140	3450	5390
Back lash	1.5 mm or less					
Manual release	Non-locking type, Locking type					

Standard Strokes

Bore size	Standard stroke [mm]
32	25, 50, 75, 100, 125, 150, 175, 200, 250, 300, 350, 400, 450, 500
40	25, 50, 75, 100, 125, 150, 175, 200, 250, 300, 350, 400, 450, 500
50	25, 50, 75, 100, 125, 150, 175, 200, 250, 300, 350, 400, 450, 500, 600
63	25, 50, 75, 100, 125, 150, 175, 200, 250, 300, 350, 400, 450, 500, 600
80	25, 50, 75, 100, 125, 150, 175, 200, 250, 300, 350, 400, 450, 500, 600, 700, 800
100	25, 50, 75, 100, 125, 150, 175, 200, 250, 300, 350, 400, 450, 500, 600, 700, 800

Note 1) Intermediate strokes are available. (No spacer is used.)

Note 2) Using a stroke of a length which is smaller than the effective cushion length may result in reduced air cushion performance. Refer to "Technical Data 1" on page 1573 for details on the effective cushion length.

Accessories

Mounting		Basic	Axial foot	Rod flange	Head flange	Single clevis	Double clevis	Center trunnion
Standard	Rod end nut	●	●	●	●	●	●	●
	Clevis pin	—	—	—	—	—	●	—
	Locking release bolt (N type only)	●	●	●	●	●	●	●
Option	Single knuckle joint	●	●	●	●	●	●	●
	Double knuckle joint (with pin)	●	●	●	●	●	●	●
	Rod boot	●	●	●	●	●	●	●

* Refer to page 491 for dimensions and part numbers. (Except locking release bolt and rod boot)

MBB Series

Weights/Aluminum Tube

Bore size [mm]		32	40	50	63	80	100
Basic weight	Basic	0.50	0.69	1.19	1.47	2.73	3.7
	Axial foot	0.68	0.93	1.56	1.93	3.61	4.8
	Rod/Head flange	0.79	1.06	1.64	2.26	4.18	5.53
	Single clevis	0.75	0.92	1.53	2.1	3.84	5.28
	Double clevis	0.76	0.96	1.62	2.26	4.13	5.55
	Center trunnion	0.79	1.05	1.67	2.27	4.28	5.39
Additional weight per 50 mm of stroke	All mounting brackets	0.11	0.16	0.26	0.27	0.42	0.56
Accessories	Single knuckle joint	0.15	0.23	0.26	0.26	0.60	0.83
	Double knuckle joint (with pin)	0.22	0.37	0.43	0.43	0.87	1.27

Mounting Brackets/Part No.

Bore size [mm]	32	40	50	63	80	100
Axial foot <small>Note 1)</small>	MB-L03	MB-L04	MB-L05	MB-L06	MB-L08	MB-L10
Rod/Head flange	MB-F03	MB-F04	MB-F05	MB-F06	MB-F08	MB-F10
Single clevis	MB-C03	MB-C04	MB-C05	MB-C06	MB-C08	MB-C10
Double clevis	MB-D03	MB-D04	MB-D05	MB-D06	MB-D08	MB-D10

Note 1) Order two feet per cylinder.

Note 2) Accessories for each mounting bracket are as follows.

Axial foot, Rod/Head flange, Single clevis/Body mounting bolt; Double clevis/ Body mounting bolt, Clevis pins, Flat washer and Split pins. → Refer to page 491 for details.

Additional Weight of Locking Part

Bore size [mm]		32	40	50	63	80	100
Manual release non-locking (N)	Locking at head end (H)	0.08	0.13	0.21	0.30	0.75	1.1
	Locking at rod end (R)	0.08	0.13	0.20	0.29	0.71	1.03
	Locking at both ends (W)	0.16	0.26	0.41	0.59	1.46	2.13
Manual release locking (L)	Locking at head end (H)	0.09	0.15	0.23	0.32	0.78	1.13
	Locking at rod end (R)	0.09	0.15	0.22	0.31	0.74	1.06
	Locking at both ends (W)	0.18	0.30	0.45	0.63	1.52	2.19

Calculation

Example) **MBBL32-100-HN**

- Basic weight..... 0.68
- Additional weight..... 0.11/50 stroke
- Cylinder stroke..... 100 stroke
- Locking weight..... 0.08 (Locking at head end, manual release non-locking type)

$$0.68 + 0.11 \times 100/50 + 0.08 = \mathbf{0.98 \text{ kg}}$$

Construction

Locking at head end

Manual release non-locking type: N

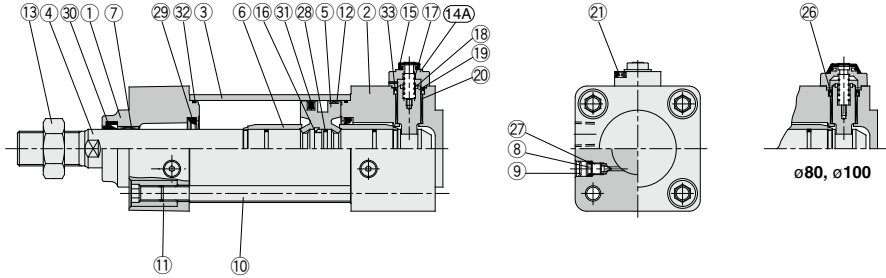

Locking at rod end

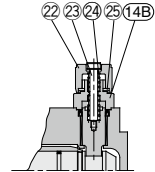
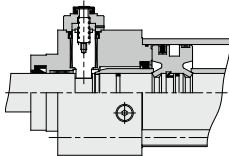

Manual release locking type: L

Component Parts

No.	Description	Material	Note
1	Rod cover	Aluminum alloy	Metallic painted
2	Head cover	Aluminum alloy	Metallic painted
3	Cylinder tube	Aluminum alloy	Hard anodized
4	Piston rod	Carbon steel	Hard chrome plating
5	Piston	Aluminum alloy	Chromated
6	Cushion ring	Aluminum alloy	Anodized
7	Bushing	Bearing alloy	
8	Cushion valve	Steel wire	Trivalent zinc chromated
9	Retaining ring	Steel for spring	ø40 to ø100
10	Tie-rod	Carbon steel	Trivalent zinc chromated
11	Tie-rod nut	Carbon steel	Trivalent zinc chromated
12	Wear ring	Resin	
13	Rod end nut	Carbon steel	Trivalent zinc chromated
14A	Cover A	Aluminum alloy	Painted black
14B	Cover B	Carbon steel	Tuffride
15	Rubber cover	Synthetic rubber	
16	Piston holder	Urethane	

Component Parts

No.	Description	Material	Note
17	Lock spring	Steel wire	
18	Bumper	Urethane	
19	Lock piston	Carbon steel	Hardened, Hard chrome plating
20	Lock bushing	Copper alloy	
21	Bolt with hex. hole	Alloyed steel	Black zinc chromated
22	M/O knob	Zinc alloy	Painted black
23	M/O bolt	Alloyed steel	Black zinc chromated, Painted red
24	M/O spring	Steel wire	Zinc chromated
25	Stopper ring	Carbon steel	Zinc chromated
26	Seal retainer	Rolled steel	ø80, ø100 only
27	Cushion valve seal	NBR	
28	Piston gasket	NBR	
29*	Cushion seal	Urethane	
30*	Rod seal	NBR	
31*	Piston seal	NBR	
32*	Cylinder tube gasket	NBR	
33*	Lock piston seal	NBR	

Replacement Parts/Seal Kit (Locking at head or rod end)

Bore size [mm]	Kit no.	Contents
32	MBB32-PS	Set of the nos. 29, 30, 31, 32, 33
40	MBB40-PS	
50	MBB50-PS	
63	MBB63-PS	
80	MBB80-PS	
100	MBB100-PS	

Replacement Parts/Seal Kit (Locking at both ends)

Bore size [mm]	Kit no.	Contents
32	MBB32-PS-W	Set of the nos. 29, 30, 31, 32, 33
40	MBB40-PS-W	
50	MBB50-PS-W	
63	MBB63-PS-W	
80	MBB80-PS-W	
100	MBB100-PS-W	

* Seal kits consist of items 29 to 33, and can be ordered by using the seal kit number corresponding to each bore size.

* Trunnion type should not be disassembled. (Refer to page 524.)

* Seal kit includes a grease pack (ø32 to 50: 10 g, ø63, 80: 20 g, ø100: 30 g). Order with the following part number when only the grease pack is needed.

Grease pack part number: GR-S-010 (10 g), GR-S-020 (20 g)

MBB Series

Basic: (B)

Locking at head end: MBBB — — H□

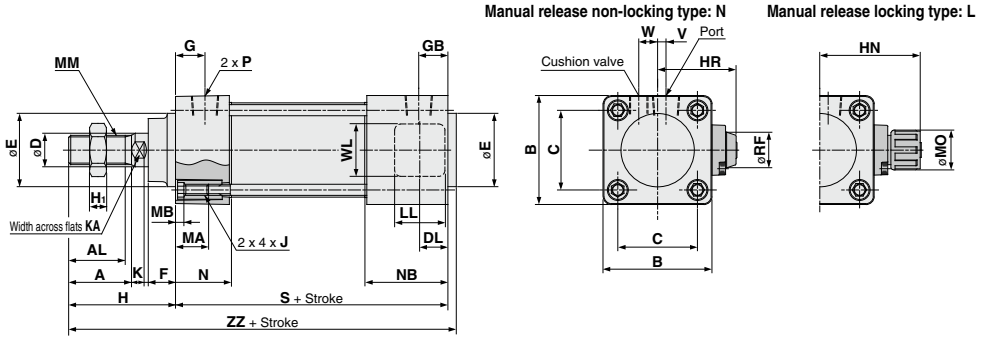

Locking at rod end: MBBB — — R□

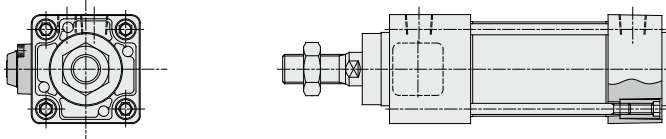

Locking at both ends: MBBB — — W□

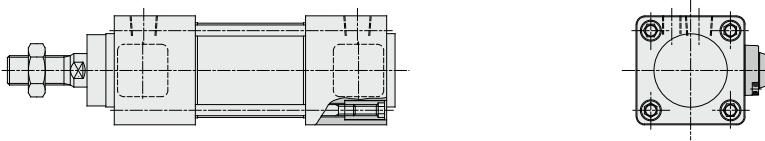

-H□/R□

Bore size [mm]	AL	KA	A	B	C	D	DL	E	F	G	GB	H ₁	H	HR	HN	J	K	LL	MA	MB
32	19.5	10	22	46	32.5	12	9	30	13	13	21	6	47	33.5	45	M6 x 1	6	15	16	4
40	27	14	30	52	38	16	12	35	13	14	27	8	51	38.5	52.5	M6 x 1	6	21	16	4
50	32	18	35	65	46.5	20	13	40	14	15.5	27.5	11	58	45	59	M8 x 1.25	7	21	16	5
63	32	18	35	75	56.5	20	13	45	14	16.5	28.5	11	58	50	64	M8 x 1.25	7	21	16	5
80	37	22	40	95	72	25	16	45	20	19	37	13	72	62	76.5	M10 x 1.5	10	30	16	5
100	37	26	40	114	89	30	16	55	20	19	37	16	72	71.5	86	M10 x 1.5	10	30	16	5

-W□

Bore size [mm]	MM	MO	N	NB	P	RF	S	V	W	WL	ZZ	S	ZZ
32	M10 x 1.25	15	27	35	1/8	11	92	4	6.5	24	143	100	151
40	M14 x 1.5	19	27	40	1/4	11	97	4	9	24	152	110	165
50	M18 x 1.5	19	31.5	43.5	1/4	11	106	5	10.5	24	168	118	180
63	M18 x 1.5	19	31.5	43.5	3/8	11	106	9	12	24	168	118	180
80	M22 x 1.5	23	38	56	3/8	21	132	11.5	14	40	208	150	226
100	M26 x 1.5	23	38	56	1/2	21	132	17	15	40	208	150	226

With Mounting Bracket

Axial foot: (L) / Locking at head end: (-H□)

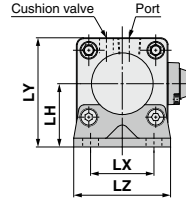
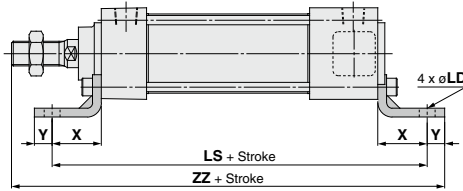

-H□/-R□

[mm] **-W□**

Bore size [mm]	X	Y	LD	LH	LS	LT	LX	LY	LZ	ZZ	LS	ZZ
32	22	9	7	30	136	3.2	32	53	50	170	144	178
40	24	11	9	33	145	3.2	38	59	55	183	158	196
50	27	11	9	40	160	3.2	46	72.5	70	202	172	214
63	27	14	12	45	160	3.6	56	82.5	80	205	172	217
80	30	14	12	55	192	4.5	72	102.5	100	248	210	266
100	32	16	14	65	196	4.5	89	122	120	252	214	270

Rod flange: (F) / Locking at head end: (-H□)

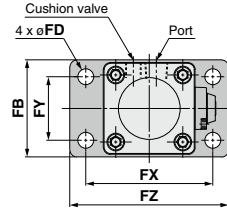
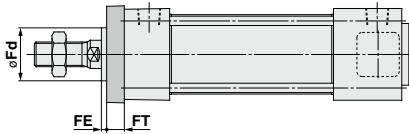

-H□/-R□/-W□

[mm]

Bore size [mm]	FB	FD	FE	FT	FX	FY	FZ	Fd
32	50	7	3	10	64	32	79	25
40	55	9	3	10	72	36	90	31
50	70	9	2	12	90	45	110	38.5
63	80	9	2	12	100	50	120	39.5
80	100	12	4	16	126	63	153	45
100	120	14	4	16	150	75	178	54

Head flange: (G) / Locking at head end: (-H□)

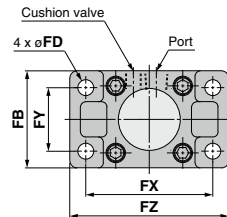
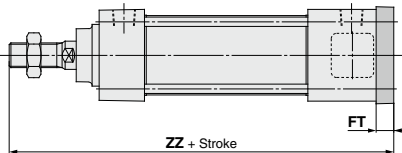

-H□/-R□

[mm] **-W□**

Bore size [mm]	FB	FD	FT	FX	FY	FZ	ZZ	ZZ
32	50	7	10	64	32	79	149	157
40	55	9	10	72	36	90	158	171
50	70	9	12	90	45	110	176	188
63	80	9	12	100	50	120	176	188
80	100	12	16	126	63	153	220	238
100	120	14	16	150	75	178	220	238

MBB Series

With Mounting Bracket

Single clevis: (C) / Locking at head end: (-H□)

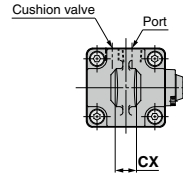
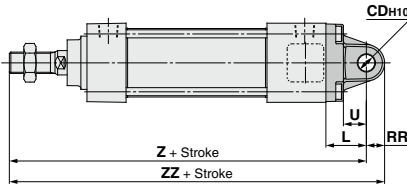

-H□-R□

Bore size [mm]	[mm]								-W□	
	L	RR	U	CDH10	CX ^{+0.1 -0.3}	Z	ZZ	Z	ZZ	
32	23	10.5	13	10	14	162	172.5	170	180.5	
40	23	11	13	10	14	171	182	184	195	
50	30	15	17	14	20	194	209	206	221	
63	30	15	17	14	20	194	209	206	221	
80	42	23	26	22	30	246	269	264	287	
100	42	23	26	22	30	246	269	264	287	

Double clevis: (D) / Locking at head end: (-H□)

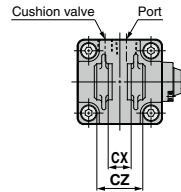
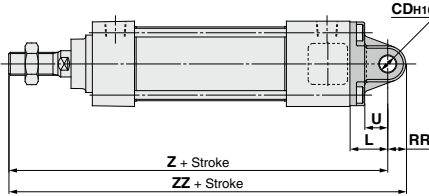

-H□-R□

Bore size [mm]	[mm]								-W□	
	L	RR	U	CDH10	CX ^{+0.3 -0.1}	CZ	Z	ZZ	Z	ZZ
32	23	10.5	13	10	14	28	162	172.5	170	180.5
40	23	11	13	10	14	28	171	182	184	195
50	30	15	17	14	20	40	194	209	206	221
63	30	15	17	14	20	40	194	209	206	221
80	42	23	26	22	30	60	246	269	264	287
100	42	23	26	22	30	60	246	269	264	287

Center trunnion: (T) / Locking at head end: (-H□)

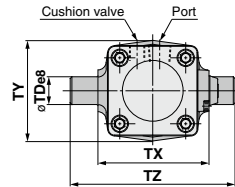
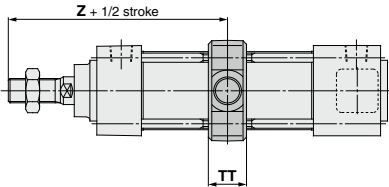

-H□

Bore size [mm]	[mm]							-R□-W□	
	TD _e	TT	TX	TY	TZ	Z	Z	Z	Z
32	12	17	50	49	74	89	97		
40	16	22	63	58	95	93	106		
50	16	22	75	71	107	105	117		
63	20	28	90	87	130	105	117		
80	20	34	110	110	150	129	147		
100	25	40	132	136	182	129	147		



MBB Series Specific Product Precautions

Be sure to read this before handling the products. Refer to page 20 for safety instructions and pages 21 to 30 for actuator and auto switch precautions.

Handling

1. Use recommended pneumatic circuit.

⚠ Caution

For correct operation of locking or releasing mechanism, use the following pneumatic circuit.

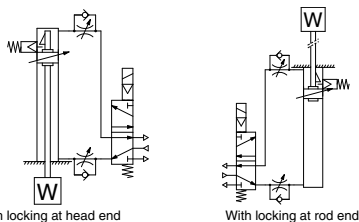

① Do not use a 3-position solenoid valve.

Avoid using circuit with 3-position solenoid valve (especially closed center, metal seal type).

When pressure is trapped in the port with locking mechanism, end lock is free. When utilizing a 3-position closed center valve, even if the lock is engaged, it may become unlocked due to pressure leakage either across the piston or the valve spool.

② Back pressure is required to release lock.

Before starting operation, supply air to side without locking mechanism as figure above. (or side without locking the piston rod for models with locking at both ends.) Otherwise, lock may not be released. (Refer to "Release of lock".)

③ Release lock when mounting or adjusting the cylinder.

If mounting is done with lock engaged, lock may be damaged.

④ Use with load 50% or less of rated capacity.

If cylinder is used over 50% load capacity, lock may be damaged.

⑤ Do not use multiple cylinders synchronously.

Avoid using 2 or more end lock cylinders synchronously to perform a single task because one of the cylinders may not allow lock to release.

⑥ Use a speed controller as meter-out.

Meter-in control may not allow lock to release.

⑦ Use complete stroke or cylinder at side with lock.

If cylinder piston does not reach end of stroke, lock may not be engaged or released.

2. Operating pressure

⚠ Caution

Use pressures 0.15 MPa or more at port with locking mechanism. Otherwise, lock will not be released.

3. Exhaust speed

⚠ Caution

When pressures at port with locking mechanism is decreased to 0.05 MPa or less, it is automatically locked. When exhaust pipe at port with locking mechanism is thin and long or speed controller is distanced from cylinder port, exhaust speed is slow and will require additional time for lock engagement. Clogging the silencer mounted on exhaust port of solenoid valve leads to the same result.

4. Relationship with cushion

⚠ Caution

When cushion valve at side with locking mechanism is fully closed or nearly fully closed, piston rod may not reach the stroke end. Thus lock is not established. And when locking is done with the cushion valve nearly fully closed, adjust the cushion valve since lock may not be released.

5. Release of lock

⚠ Warning

When lock is to be released, supply air pressure to the port without the locking mechanism, this relieves the load from the lock mechanism. (Refer to recommended pneumatic circuit.) When port without lock mechanism is exhausted and locking mechanism is loaded, the lock may be damaged due to excessive force on lock during release. Also, piston rod will operate immediately.

6. Manual release

⚠ Caution

Non-locking type

Insert attached bolt under upper side of rubber cover (no need to remove rubber cover), tighten locking piston and pull bolt, lock will be released. When bolt is released, locking begins to take place. Thread size, required pulling force and stroke are listed below.

Bore size [mm]	Thread size	Pulling force	Stroke [mm]
32	≥ M2.5 x 0.45 x 25 L	4.9 N	2
40, 50, 63	≥ M3 x 0.5 x 30 L	10 N	3
80, 100	≥ M5 x 0.8 x 40 L	24.5 N	3

* Remove bolt under normal operations. It may cause malfunction of locking and release.

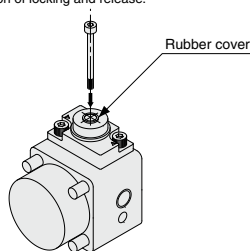

Locking type

Turn 90° counterclockwise while pushing the M/O knob. Lock is released when ▲ on the cap and ▼ OFF mark on the M/O knob correspond. (Lock remains released.)

When locking is desired, turn 90° clockwise while fully pushing the M/O knob and correspond ▲ on the cap and ▼ ON mark on the M/O knob. Confirm the correct position by click sound "click". Otherwise, lock may not be engaged.

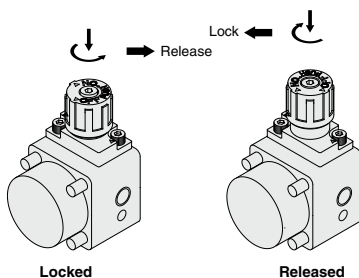

MB Series

Auto Switch Mounting

Auto Switch Proper Mounting Position (Detection at stroke end) and Its Mounting Height

<Band mounting>

D-G39/K39/A3□

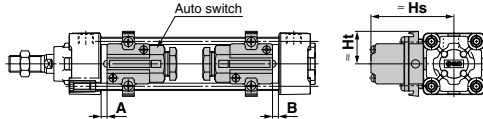

D-A44

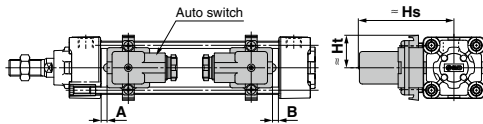

<Tie-rod mounting>

D-M9□/M9□V

D-M9□W/M9□WV

D-M9□A/M9□AV

D-A9□/A9□V

D-Y59□/Y69□/Y7P/Y7PV

D-Y7□W/Y7□WV/Y7BA

D-Z7□/Z80

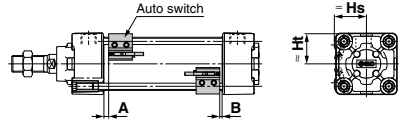

D-A5□/A6□

D-A59W

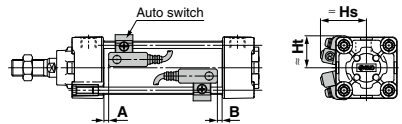

D-F5□/J59

D-F5□W/J59W/F5BA

D-F59F/F5NT

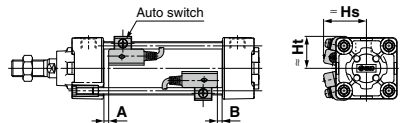

D-P3DWA

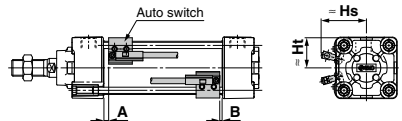

D-P4DW

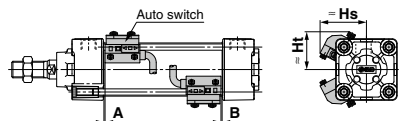

Auto Switch Proper Mounting Position (Detection at stroke end) and Its Mounting Height

Auto Switch Proper Mounting Position (Standard type)

[mm]

Auto switch model	D-M9□ D-M9□V D-M9□W D-M9□WV D-M9□A D-M9□AV		D-A9□ D-A9□V		D-F5□ D-J59 D-F59F		D-F5NT		D-A5□ D-A6□		D-A59W		D-G39 D-K39 D-A3□ D-A44		D-Y59□ D-Y69□ D-Y7P D-Y7PV D-Y7H D-Y7□W D-Y7□WV D-Z7□ D-Z8□		D-P3DWA		D-P4DW	
	A	B	A	B	A	B	A	B	A	B	A	B	A	B	A	B	A	B	A	B
32	10	8	6	4	6.5	4.5	11.5	9.5	0	0	4	2	0	0	3.5	1.5	5.5	3.5	3	1
40	9	9	5	5	5.5	5.5	10.5	10.5	0	0	3	3	0	0	2.5	2.5	4.5	4.5	2	2
50	10	9	6	5	6.5	5.5	11.5	10.5	0	0	4	3	0	0	3.5	2.5	5.5	4.5	3	2
63	10	9	6	5	6.5	5.5	11.5	10.5	0	0	4	3	0	0	3.5	2.5	5.5	4.5	3	2
80	14.5	11.5	10.5	7.5	11	8	16	13	4.5	1.5	8.5	5.5	4.5	1.5	8	5	10	7	7.5	4.5
100	14	12	10	8	10.5	8.5	15.5	13.5	4	2	8	6	4	2	7.5	5.5	9.5	7.5	7	5
125	16	16	12	12	12.5	12.5	17.5	17.5	6	6	10	10	6	6	9.5	9.5	11.5	11.5	9	9

* Models with rubber bumper have different dimensions for auto switch proper mounting positions (A and B). Add the following values to both A and B: 3 mm (ø32 and 40), 4 mm (ø50 and 63), 5 mm (ø80 and 100), 6 mm (ø125).

Note) Adjust the auto switch after confirming the operating conditions in the actual setting.

Auto Switch Proper Mounting Height (Standard type)

[mm]

Auto switch model	D-M9□ D-M9□W D-M9□A D-A9□		D-A9□V		D-M9□V D-M9□WV D-M9□AV		D-F5□ D-J59 D-F59F D-F5□W D-J59W D-F5BA D-F5NT		D-A5□ D-A6□ D-A59W		D-G39 D-K39 D-A3□		D-A44		D-Y59□ D-Y7P D-Y7□W D-Y7BA D-Z7□ D-Z8□		D-Y69□ D-Y7PV D-Y7□WV		D-P3DWA		D-P4DW	
	Hs	Ht	Hs	Ht	Hs	Ht	Hs	Ht	Hs	Ht	Hs	Ht	Hs	Ht	Hs	Ht	Hs	Ht	Hs	Ht	Hs	Ht
32	24.5	23	27.5	23	30.5	23	32.5	25	35	24.5	67	27.5	77	27.5	25.5	23	26.5	23	38	31	38	31
40	28.5	25.5	31.5	25.5	34	25.5	36.5	27.5	38.5	27.5	71.5	27.5	81.5	27.5	29.5	26	30	26	39	25.5	42	33
50	33.5	31	36	31	38.5	31	41	34	43.5	34.5	77	—	87	—	33.5	31	34.5	31	43	31	46.5	39
63	38.5	36	40.5	36	43	36	46	39	48.5	39.5	83.5	—	93.5	—	39	36	40	36	48	36	51.5	44
80	46.5	45	49	45	52	45	52.5	46.5	55	46.5	92.5	—	103	—	47.5	45	48.5	45	56.5	45	58	51.5
100	54	53.5	57	53.5	59.5	53.5	59.5	55	62	55	103	—	113.5	—	55.5	53.5	56.5	53.5	64.5	53.5	65.5	60.5
125	65.5	64.5	68.5	64.5	71	64.5	70.5	66.5	71.5	66.5	115	—	125	—	67.5	65	68.5	65	76	64.5	76.5	72

Auto Switch Proper Mounting Position (Detection at stroke end) and Its Mounting Height

Auto Switch Proper Mounting Position (Non-rotating rod type, With end lock)

[mm]

Auto switch model	D-M9□ D-M9□V D-M9□W D-M9□WV D-M9□A D-M9□AV		D-A9□ D-A9□V		D-F5□ D-J59 D-F59F		D-F5NT		D-A5□ D-A6□		D-A59W		D-G39 D-K39 D-A3□ D-A44		D-Y59□ D-Y69□ D-Y7P D-Y7PV D-Y7H D-Y7□W D-Y7□WV D-Z7□ D-Z8□		D-P3DWA		D-P4DW	
	A	B	A	B	A	B	A	B	A	B	A	B	A	B	A	B	A	B	A	B
32	10.5	8	6.5	4	7	4.5	12	9.5	0.5	0	4.5	2	0.5	0	4	1.5	5.5	3.5	3.5	1
40	10.5	8	6.5	4	7	4.5	12	9.5	0.5	0	4.5	2	0.5	0	4	1.5	6	3.5	3.5	1
50	11	8.5	7	4.5	7.5	5	12.5	10	1	0	5	2.5	1	0	4.5	2	6.5	4	4	1.5
63	11	8.5	7	4.5	7.5	5	12.5	10	1	0	5	2.5	1	0	4.5	2	6.5	4	4	1.5
80	14	12.5	10	8.5	10.5	9	15.5	14	4	2.5	8	6.5	4	2.5	7.5	6	9.5	8	7	5.5
100	14	12.5	10	8.5	10.5	9	15.5	14	4	2.5	8	6.5	4	2.5	7.5	6	9.5	8	7	5.5

* Models with rubber bumper have different dimensions for auto switch proper mounting positions (A and B). Add the following values to both A and B: 3 mm (ø32 and 40), 4 mm (ø50 and 63), 5 mm (ø80 and 100).

Note) Adjust the auto switch after confirming the operating conditions in the actual setting.

Auto Switch Proper Mounting Height (Non-rotating rod type, With end lock)

[mm]

Auto switch model	D-M9□ D-M9□W D-M9□A D-A9□		D-A9□V		D-M9□V D-M9□WV D-M9□AV		D-F5□ D-J59 D-F59F D-F5□W D-J59W D-F5BA D-F5NT		D-A5□ D-A6□ D-A59W		D-G39 D-K39 D-A3□		D-A44		D-Y59□ D-Y7P D-Y7□W D-Y7BA D-Z7□ D-Z8□		D-Y69□ D-Y7PV D-Y7□WV		D-P3DWA		D-P4DW	
	Hs	Ht	Hs	Ht	Hs	Ht	Hs	Ht	Hs	Ht	Hs	Ht	Hs	Ht	Hs	Ht	Hs	Ht	Hs	Ht	Hs	Ht
32	24.5	23	27.5	23	30.5	23	32.5	25	35	24.5	67	27.5	77	27.5	25.5	23	26.5	23	38	31	38	31
40	28.5	25.5	31.5	25.5	34	25.5	36.5	27.5	38.5	27.5	71.5	27.5	81.5	27.5	29.5	26	30	26	39	25.5	42	33
50	33.5	31	36	31	38.5	31	41	34	43.5	34.5	77	—	87	—	33.5	31	34.5	31	43	31	46.5	39
63	38.5	36	40.5	36	43	36	46	39	48.5	39.5	83.5	—	93.5	—	39	36	40	36	48	36	51.5	44
80	46.5	45	49	45	52	45	52.5	46.5	55	46.5	92.5	—	103	—	47.5	45	48.5	45	56.5	45	58	51.5
100	54	53.5	57	53.5	59.5	53.5	59.5	55	62	55	103	—	113.5	—	55.5	53.5	56.5	53.5	64.5	53.5	65.5	60.5

Minimum Stroke for Auto Switch Mounting

Mounting Brackets Except Center Trunnion

n: Number of auto switches [mm]

Auto switch model	Number of auto switches	ø32, ø40, ø50, ø63	ø80, ø100	ø125 <small>Note 2)</small>
D-M9 □ D-M9 □W	2 (Different surfaces, same surface) 1	15		
	n	$15 + 40 \frac{(n-2)}{2}$ (n = 2, 4, 6, 8...) <small>Note 1)</small>		
D-M9 □V D-M9 □WV	2 (Different surfaces, same surface) 1	10		
	n	$10 + 30 \frac{(n-2)}{2}$ (n = 2, 4, 6, 8...) <small>Note 1)</small>		
D-M9 □A	2 (Different surfaces, same surface) 1	15		
	n	$15 + 40 \frac{(n-2)}{2}$ (n = 2, 4, 6, 8...) <small>Note 1)</small>		
D-M9 □AV	2 (Different surfaces, same surface) 1	15		
	n	$15 + 30 \frac{(n-2)}{2}$ (n = 2, 4, 6, 8...) <small>Note 1)</small>		
D-A9 □	2 (Different surfaces, same surface) 1	15		
	n	$15 + 40 \frac{(n-2)}{2}$ (n = 2, 4, 6, 8...) <small>Note 1)</small>		
D-A9 □V	2 (Different surfaces, same surface) 1	10		
	n	$10 + 30 \frac{(n-2)}{2}$ (n = 2, 4, 6, 8...) <small>Note 1)</small>		
D-G39 D-K39 D-A3 □	2 (Different surfaces)	35		
	2 (Same surface)	100		
	n (Different surfaces)	$35 + 30 (n - 2)$ (n = 2, 3, 4...)		
	n (Same surface)	$100 + 100 (n - 2)$ (n = 2, 3, 4...)		
	1	10		
D-A44	2 (Different surfaces)	35		
	2 (Same surface)	55		
	n (Different surfaces)	$35 + 30 (n - 2)$ (n = 2, 3, 4...)		
	n (Same surface)	$55 + 50 (n - 2)$ (n = 2, 3, 4...)		
	1	10		
D-F5 □ D-J59 D-F5 □W D-J59 W D-F5BA D-F59F	2 (Different surfaces, same surface) 1	15	25	25
	n (Same surface)	$15 + 55 \frac{(n-2)}{2}$ (n = 2, 4, 6, 8...) <small>Note 1)</small>	$25 + 55 \frac{(n-2)}{2}$ (n = 2, 4, 6, 8...) <small>Note 1)</small>	$25 + 55 \frac{(n-2)}{2}$ (n = 2, 4, 6, 8...) <small>Note 1)</small>
	1	10	25	25
	2 (Different surfaces, same surface) 1	15	20	20
D-A5 □ D-A6 □	2 (Different surfaces, same surface) 1	20	25	25
	n (Different surfaces)	$15 + 55 \frac{(n-2)}{2}$ (n = 2, 4, 6, 8...) <small>Note 1)</small>	$20 + 55 \frac{(n-2)}{2}$ (n = 2, 4, 6, 8...) <small>Note 1)</small>	$20 + 55 \frac{(n-2)}{2}$ (n = 2, 4, 6, 8...) <small>Note 1)</small>
D-A59W	2 (Different surfaces, same surface) 1	20	25	25
	n (Same surface)	$20 + 55 \frac{(n-2)}{2}$ (n = 2, 4, 6, 8...) <small>Note 1)</small>	$25 + 55 \frac{(n-2)}{2}$ (n = 2, 4, 6, 8...) <small>Note 1)</small>	$25 + 55 \frac{(n-2)}{2}$ (n = 2, 4, 6, 8...) <small>Note 1)</small>
	1	15	25	25
D-F5NT	2 (Different surfaces, same surface) 1	15	25	30
	n (Same surface)	$15 + 55 \frac{(n-2)}{2}$ (n = 2, 4, 6, 8...) <small>Note 1)</small>	$25 + 55 \frac{(n-2)}{2}$ (n = 2, 4, 6, 8...) <small>Note 1)</small>	$30 + 55 \frac{(n-2)}{2}$ (n = 2, 4, 6, 8...) <small>Note 1)</small>
	1	10	25	30
D-Y59 □ D-Y7P D-Y7 □W D-Z70 D-Z80	2 (Different surfaces, same surface) 1	15		
	n	$15 + 40 \frac{(n-2)}{2}$ (n = 2, 4, 6, 8...) <small>Note 1)</small>		

Note 1) When "n" is an odd number, an even number that is one larger than this odd number is used for the calculation.

Note 2) Non-rotating rod type and with end lock are applicable to ø32 to ø100.

Minimum Stroke for Auto Switch Mounting

Mounting Brackets Except Center Trunnion

n: Number of auto switches [mm]

Auto switch model	Number of auto switches	ø32, ø40, ø50, ø63, ø80, ø100	ø125 Note 3)
D-Y69□ D-Y7PV D-Y7□WV	2 (Different surfaces, same surface) 1	10	
	n	$10 + 30 \frac{(n-2)}{2}$ (n = 2, 4, 6, 8...) Note 1)	
D-Y7BA	2 (Different surfaces, same surface) 1	20	
	n	$20 + 45 \frac{(n-2)}{2}$ (n = 2, 4, 6, 8...) Note 1)	
D-P3DWA	2 (Different surfaces, same surface) 1	15	
	n	$15 + 50 \frac{(n-2)}{2}$ (n = 2, 4, 6, 8...) Note 1)	
D-P4DW	2 (Different surfaces, same surface) 1	15	20
	n	$15 + 65 \frac{(n-2)}{2}$ (n = 2, 4, 6, 8...) Note 1)	$20 + 65 \frac{(n-2)}{2}$ (n = 2, 4, 6, 8...) Note 1)

Note 1) When "n" is an odd number, an even number that is one larger than this odd number is used for the calculation.

Note 3) Non-rotating rod type and with end lock are applicable to ø32 to ø100.

Center Trunnion

n: Number of auto switches [mm]

Auto switch model	Number of auto switches	ø32	ø40	ø50	ø63	ø80	ø100	ø125 Note 3)
D-M9□ D-M9□W	2 (Different surfaces, same surface) 1	75	80	85	90	95	105	
	n	$75 + 40 \frac{(n-4)}{2}$ (n = 4, 8, 12, 16...) Note 2)	$80 + 40 \frac{(n-4)}{2}$ (n = 4, 8, 12, 16...) Note 2)	$85 + 40 \frac{(n-4)}{2}$ (n = 4, 8, 12, 16...) Note 2)	$90 + 40 \frac{(n-4)}{2}$ (n = 4, 8, 12, 16...) Note 2)	$95 + 40 \frac{(n-4)}{2}$ (n = 4, 8, 12, 16...) Note 2)	$105 + 40 \frac{(n-4)}{2}$ (n = 4, 8, 12, 16...) Note 2)	
D-M9□V D-M9□WV	2 (Different surfaces, same surface) 1	50	55	60	65	70	80	
	n	$50 + 30 \frac{(n-4)}{2}$ (n = 4, 8, 12, 16...) Note 2)	$55 + 30 \frac{(n-4)}{2}$ (n = 4, 8, 12, 16...) Note 2)	$60 + 30 \frac{(n-4)}{2}$ (n = 4, 8, 12, 16...) Note 2)	$65 + 30 \frac{(n-4)}{2}$ (n = 4, 8, 12, 16...) Note 2)	$70 + 30 \frac{(n-4)}{2}$ (n = 4, 8, 12, 16...) Note 2)	$80 + 30 \frac{(n-4)}{2}$ (n = 4, 8, 12, 16...) Note 2)	
D-M9□A	2 (Different surfaces, same surface) 1	80	85	90	95	100	110	
	n	$80 + 40 \frac{(n-4)}{2}$ (n = 4, 8, 12, 16...) Note 2)	$85 + 40 \frac{(n-4)}{2}$ (n = 4, 8, 12, 16...) Note 2)	$90 + 40 \frac{(n-4)}{2}$ (n = 4, 8, 12, 16...) Note 2)	$95 + 40 \frac{(n-4)}{2}$ (n = 4, 8, 12, 16...) Note 2)	$100 + 40 \frac{(n-4)}{2}$ (n = 4, 8, 12, 16...) Note 2)	$110 + 40 \frac{(n-4)}{2}$ (n = 4, 8, 12, 16...) Note 2)	
D-M9□AV	2 (Different surfaces, same surface) 1	55	60	65	70	75	85	
	n	$55 + 30 \frac{(n-4)}{2}$ (n = 4, 8, 12, 16...) Note 2)	$60 + 30 \frac{(n-4)}{2}$ (n = 4, 8, 12, 16...) Note 2)	$65 + 30 \frac{(n-4)}{2}$ (n = 4, 8, 12, 16...) Note 2)	$70 + 30 \frac{(n-4)}{2}$ (n = 4, 8, 12, 16...) Note 2)	$75 + 30 \frac{(n-4)}{2}$ (n = 4, 8, 12, 16...) Note 2)	$85 + 30 \frac{(n-4)}{2}$ (n = 4, 8, 12, 16...) Note 2)	
D-A9□	2 (Different surfaces, same surface) 1	70	75	80	85	95	100	
	n	$70 + 40 \frac{(n-4)}{2}$ (n = 4, 8, 12, 16...) Note 2)	$75 + 40 \frac{(n-4)}{2}$ (n = 4, 8, 12, 16...) Note 2)	$80 + 40 \frac{(n-4)}{2}$ (n = 4, 8, 12, 16...) Note 2)	$85 + 40 \frac{(n-4)}{2}$ (n = 4, 8, 12, 16...) Note 2)	$95 + 40 \frac{(n-4)}{2}$ (n = 4, 8, 12, 16...) Note 2)	$100 + 40 \frac{(n-4)}{2}$ (n = 4, 8, 12, 16...) Note 2)	
D-A9□V	2 (Different surfaces, same surface) 1	45	50	55	60	70	75	
	n	$45 + 30 \frac{(n-4)}{2}$ (n = 4, 8, 12, 16...) Note 2)	$50 + 30 \frac{(n-4)}{2}$ (n = 4, 8, 12, 16...) Note 2)	$55 + 30 \frac{(n-4)}{2}$ (n = 4, 8, 12, 16...) Note 2)	$60 + 30 \frac{(n-4)}{2}$ (n = 4, 8, 12, 16...) Note 2)	$70 + 30 \frac{(n-4)}{2}$ (n = 4, 8, 12, 16...) Note 2)	$75 + 30 \frac{(n-4)}{2}$ (n = 4, 8, 12, 16...) Note 2)	

Note 2) When "n" is an odd number, a multiple of 4 that is larger than this odd number is used for the calculation.

Note 3) Non-rotating rod type and with end lock are applicable to ø32 to ø100.

Minimum Stroke for Auto Switch Mounting

Center Trunnion

n: Number of auto switches [mm]

Auto switch model	Number of auto switches	ø32	ø40	ø50	ø63	ø80	ø100	ø125 (Note 3)	
D-G39 D-K39 D-A3□	2 (Different surfaces)	60	65	75	80	85	90	90	
	2 (Same surface)	90	95	100	105	110	125		
	n (Different surfaces)	$60 + 30(n-2)$ (n = 2, 4, 6, 8...) Note 1	$65 + 30(n-2)$ (n = 2, 4, 6, 8...) Note 1	$75 + 30(n-2)$ (n = 2, 4, 6, 8...) Note 1	$80 + 30(n-2)$ (n = 2, 4, 6, 8...) Note 1	$85 + 30(n-2)$ (n = 2, 4, 6, 8...) Note 1	$90 + 30(n-2)$ (n = 2, 4, 6, 8...) Note 1		
	n (Same surface)	$90 + 100(n-2)$ (n = 2, 4, 6, 8...) Note 1	$95 + 100(n-2)$ (n = 2, 4, 6, 8...) Note 1	$100 + 100(n-2)$ (n = 2, 4, 6, 8...) Note 1	$105 + 100(n-2)$ (n = 2, 4, 6, 8...) Note 1	$110 + 100(n-2)$ (n = 2, 4, 6, 8...) Note 1	$125 + 100(n-2)$ (n = 2, 4, 6, 8...) Note 1		
	1	60	65	75	80	85	90		
D-A44	2 (Different surfaces)	70	75	80	85	90			
	2 (Same surface)								
	n (Different surfaces)	$70 + 30(n-2)$ (n = 2, 4, 6, 8...) Note 1	$75 + 30(n-2)$ (n = 2, 4, 6, 8...) Note 1	$80 + 30(n-2)$ (n = 2, 4, 6, 8...) Note 1	$85 + 30(n-2)$ (n = 2, 4, 6, 8...) Note 1	$90 + 30(n-2)$ (n = 2, 4, 6, 8...) Note 1			
	n (Same surface)	$70 + 50(n-2)$ (n = 2, 4, 6, 8...) Note 1	$75 + 50(n-2)$ (n = 2, 4, 6, 8...) Note 1	$80 + 50(n-2)$ (n = 2, 4, 6, 8...) Note 1	$85 + 50(n-2)$ (n = 2, 4, 6, 8...) Note 1	$90 + 50(n-2)$ (n = 2, 4, 6, 8...) Note 1			
	1	70	75	80	85	90			
D-F5□/J59 D-F5□W D-J59W D-F5BA D-F59F	2 (Different surfaces, same surface)	90	95	110	115	120	130		
	n (Same surface)	$90 + 55 \frac{(n-4)}{2}$ (n = 4, 8, 12, 16...) Note 2	$95 + 55 \frac{(n-4)}{2}$ (n = 4, 8, 12, 16...) Note 2	$110 + 55 \frac{(n-4)}{2}$ (n = 4, 8, 12, 16...) Note 2	$115 + 55 \frac{(n-4)}{2}$ (n = 4, 8, 12, 16...) Note 2	$120 + 55 \frac{(n-4)}{2}$ (n = 4, 8, 12, 16...) Note 2	$130 + 55 \frac{(n-4)}{2}$ (n = 4, 8, 12, 16...) Note 2		
	1	90	95	110	115	120	130		
	n (Same surface)	$100 + 55 \frac{(n-4)}{2}$ (n = 4, 8, 12, 16...) Note 2	$105 + 55 \frac{(n-4)}{2}$ (n = 4, 8, 12, 16...) Note 2	$120 + 55 \frac{(n-4)}{2}$ (n = 4, 8, 12, 16...) Note 2	$125 + 55 \frac{(n-4)}{2}$ (n = 4, 8, 12, 16...) Note 2	$130 + 55 \frac{(n-4)}{2}$ (n = 4, 8, 12, 16...) Note 2	$140 + 55 \frac{(n-4)}{2}$ (n = 4, 8, 12, 16...) Note 2		
	1	100	105	120	125	130	140		
D-A5□ D-A6□	2 (Different surfaces, same surface)	60	80	105	110	115			
	1								
	n (Same surface)	$60 + 55 \frac{(n-4)}{2}$ (n = 4, 8, 12, 16...) Note 2	$80 + 55 \frac{(n-4)}{2}$ (n = 4, 8, 12, 16...) Note 2	$105 + 55 \frac{(n-4)}{2}$ (n = 4, 8, 12, 16...) Note 2	$110 + 55 \frac{(n-4)}{2}$ (n = 4, 8, 12, 16...) Note 2	$115 + 55 \frac{(n-4)}{2}$ (n = 4, 8, 12, 16...) Note 2			
D-A59W	2 (Different surfaces, same surface)	60	70	85	110	115	120		
	1								
	n (Same surface)	$60 + 55 \frac{(n-4)}{2}$ (n = 4, 8, 12, 16...) Note 2	$70 + 55 \frac{(n-4)}{2}$ (n = 4, 8, 12, 16...) Note 2	$85 + 55 \frac{(n-4)}{2}$ (n = 4, 8, 12, 16...) Note 2	$110 + 55 \frac{(n-4)}{2}$ (n = 4, 8, 12, 16...) Note 2	$115 + 55 \frac{(n-4)}{2}$ (n = 4, 8, 12, 16...) Note 2	$120 + 55 \frac{(n-4)}{2}$ (n = 4, 8, 12, 16...) Note 2		
D-Y59□ D-Y7P D-Y7□W D-Z7□ D-Z80	2 (Different surfaces, same surface)	80	85	90	95	100	105		
	1								
	n	$80 + 40 \frac{(n-4)}{2}$ (n = 4, 8, 12, 16...) Note 2	$85 + 40 \frac{(n-4)}{2}$ (n = 4, 8, 12, 16...) Note 2	$90 + 40 \frac{(n-4)}{2}$ (n = 4, 8, 12, 16...) Note 2	$95 + 40 \frac{(n-4)}{2}$ (n = 4, 8, 12, 16...) Note 2	$100 + 40 \frac{(n-4)}{2}$ (n = 4, 8, 12, 16...) Note 2	$105 + 40 \frac{(n-4)}{2}$ (n = 4, 8, 12, 16...) Note 2		
	1	60	70	85	110	115	120		
	n (Same surface)	$60 + 55 \frac{(n-4)}{2}$ (n = 4, 8, 12, 16...) Note 2	$70 + 55 \frac{(n-4)}{2}$ (n = 4, 8, 12, 16...) Note 2	$85 + 55 \frac{(n-4)}{2}$ (n = 4, 8, 12, 16...) Note 2	$110 + 55 \frac{(n-4)}{2}$ (n = 4, 8, 12, 16...) Note 2	$115 + 55 \frac{(n-4)}{2}$ (n = 4, 8, 12, 16...) Note 2	$120 + 55 \frac{(n-4)}{2}$ (n = 4, 8, 12, 16...) Note 2		
D-Y69□ D-Y7PV D-Y7□WV	2 (Different surfaces, same surface)	60	65	70	75	85	85		
	1								
	n	$60 + 30 \frac{(n-4)}{2}$ (n = 4, 8, 12, 16...) Note 2	$65 + 30 \frac{(n-4)}{2}$ (n = 4, 8, 12, 16...) Note 2	$70 + 30 \frac{(n-4)}{2}$ (n = 4, 8, 12, 16...) Note 2	$75 + 30 \frac{(n-4)}{2}$ (n = 4, 8, 12, 16...) Note 2	$85 + 30 \frac{(n-4)}{2}$ (n = 4, 8, 12, 16...) Note 2	$85 + 30 \frac{(n-4)}{2}$ (n = 4, 8, 12, 16...) Note 2		
D-Y7BA	2 (Different surfaces, same surface)	85	90	100	105	110	115		
	1								
	n	$85 + 45 \frac{(n-4)}{2}$ (n = 4, 8, 12, 16...) Note 2	$90 + 45 \frac{(n-4)}{2}$ (n = 4, 8, 12, 16...) Note 2	$100 + 45 \frac{(n-4)}{2}$ (n = 4, 8, 12, 16...) Note 2	$105 + 45 \frac{(n-4)}{2}$ (n = 4, 8, 12, 16...) Note 2	$110 + 45 \frac{(n-4)}{2}$ (n = 4, 8, 12, 16...) Note 2	$115 + 45 \frac{(n-4)}{2}$ (n = 4, 8, 12, 16...) Note 2		
D-P3DWA	2 (Different surfaces, same surface)	80	85	90	95	100	100		
	1								
	n	$80 + 50 \frac{(n-4)}{2}$ (n = 4, 8, 12, 16...) Note 2	$85 + 50 \frac{(n-4)}{2}$ (n = 4, 8, 12, 16...) Note 2	$90 + 50 \frac{(n-4)}{2}$ (n = 4, 8, 12, 16...) Note 2	$95 + 50 \frac{(n-4)}{2}$ (n = 4, 8, 12, 16...) Note 2	$100 + 50 \frac{(n-4)}{2}$ (n = 4, 8, 12, 16...) Note 2	$100 + 50 \frac{(n-4)}{2}$ (n = 4, 8, 12, 16...) Note 2		
D-P4DW	2 (Different surfaces, same surface)	120	130	140	150				
	1								
	n	$120 + 65 \frac{(n-4)}{2}$ (n = 4, 8, 12, 16...) Note 2	$130 + 65 \frac{(n-4)}{2}$ (n = 4, 8, 12, 16...) Note 2	$140 + 65 \frac{(n-4)}{2}$ (n = 4, 8, 12, 16...) Note 2	$150 + 65 \frac{(n-4)}{2}$ (n = 4, 8, 12, 16...) Note 2				

Note 1) When "n" is an odd number, an even number that is one larger than this odd number is used for the calculation.

Note 2) When "n" is an odd number, a multiple of 4 that is larger than this odd number is used for the calculation.

Note 3) Non-rotating rod type and with end lock are applicable to ø32 to ø100.

Auto Switch Mounting Brackets/Part No.

Auto switch model	Bore size [mm]						
	ø32	ø40	ø50	ø63	ø80	ø100	ø125
D-M9□/M9□V D-M9□W/M9□WV D-M9□A/M9□AV D-A9□/A9□V	BMB5-032	BMB5-032	BA7-040	BA7-040	BA7-063	BA7-063	BA7-080
D-A3□/A44 D-G39/K39	BMB2-032	BMB2-040	BMB1-050	BMB1-063	BMB1-080	BMB1-100	BS1-125
D-F5□/J59 D-F5□W/J59W D-F59F/F5BA D-F5NT D-A5□/A6□/A59W	BT-03	BT-03	BT-05	BT-05	BT-06	BT-06	BT-08
D-P3DWA	BA10-032S	BA10-040S	BA10-050S	BA10-050S	BA10-063S	BA10-063S	BA10-080S
D-P4DW	BMB3T-040	BMB3T-040	BMB3T-050	BMB3T-050	BMB3T-080	BMB3T-080	BAP2T-080
D-Y59□/Y69□ D-Y7P/Y7PV D-Y7□W/Y7□WV D-Y7BA D-Z7□/Z80	BMB4-032	BMB4-032	BMB4-050	BMB4-050	BA4-063	BA4-063	BA4-080

[Stainless Steel Mounting Screw]

The following stainless steel mounting screw kit (including set screws) is available. Use it in accordance with the operating environment. (Since the auto switch mounting bracket is not included, order it separately.)

BBA1: For D-A5/A6/F5/J5 types

Note 1) Refer to page 1377 for details on the BBA1.

The above stainless steel screws are used when a cylinder is shipped with the D-F5BA auto switch. When only one auto switch is shipped independently, the BBA1 is attached.

Note 2) When using the D-M9□A(V) or Y7BA, do not use the steel set screws which are included with the auto switch mounting brackets above (BMB5-032, BA7-□□□, BMB4-□□□, BA4-□□□). Order a stainless steel screw kit (BBA1) separately, and use the M4 x 6 L stainless steel set screws included in the BBA1.

• The figure shows the mounting example for the D-M9□(V)/M9□W(V)/M9□A(V)/A9□(V).

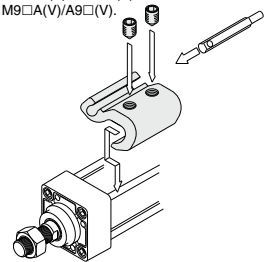

Operating Range

Auto switch model	Bore size [mm]						
	32	40	50	63	80	100	125
D-M9□/M9□V D-M9□W/M9□WV D-M9□A/M9□AV	4	4.5	4.5	4.5	5	6	7
D-Y59□/Y69□ D-Y7P/Y7□V D-Y7□W/Y7□WV D-Y7BA	5.5	5.5	7	7.5	6.5	5.5	7
D-F5□/J59 D-F5□W/J59W D-F5BA/F5NT D-F59F	3.5	4	4	4.5	4.5	4.5	5
D-G39/K39	9	9	9	10	10	11	11
D-P3DWA	3	4.5	4.5	5	5	5.5	6.5
D-P4DW	4	4	4	4.5	4	4.5	4.5
D-A9□/A9□V	7	7.5	8.5	9.5	9.5	10.5	12
D-Z7□/Z80	7.5	8.5	7.5	9.5	9.5	10.5	13
D-A5□/A6□	9	9	10	11	11	11	10
D-A59W	13	13	13	14	14	15	17
D-A3□/A44	9	9	10	11	11	11	10

* Values which include hysteresis are for guideline purposes only, they are not a guarantee (assuming approximately ±30% dispersion) and may change substantially depending on the ambient environment.

<Mounting example for ø32, D-P3DWA>

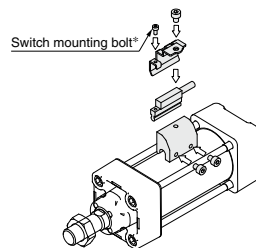

* The switch mounting bolt is supplied with the switch.

Other than the applicable auto switches listed in “How to Order”, the following auto switches are mountable.

Refer to pages 1271 to 1365 for the detailed specifications.

Type	Model	Electrical entry	Features
Solid state	D-M9NV/M9PV/M9BV	Grommet (Perpendicular)	—
	D-Y69A/Y69B/Y7PV		—
	D-M9NVW/M9PWV/M9BWW		Diagnostic indication (2-color indicator)
	D-Y7NWW/Y7PWV/Y7BWW		Water resistant (2-color indicator)
	D-M9NAV/M9PAV/M9BAV		Magnetic field resistant (2-color indicator)
	D-P4DW		—
	D-F59/F5P/J59	Grommet (In-line)	—
	D-Y59A/Y59B/Y7P		—
	D-Y7H		—
	D-F59W/F5PW/J59W		Diagnostic indication (2-color indicator)
	D-Y7NWW/Y7PWV/Y7BWW		Water resistant (2-color indicator)
	D-F5BA/Y7BA		With timer
	D-F5NT		Magnetic field resistant (2-color indicator)
	D-P5DW		—
Reed	D-A93V/A96V	Grommet (Perpendicular)	—
	D-A90V	—	Without indicator light
	D-A53/A56/Z73/Z76	Grommet (In-line)	—
	D-A67/Z80		Without indicator light

* With pre-wired connector is also available for solid state switches. For details, refer to pages 1340 and 1341.

* Normally closed (NC = b contact) solid state auto switches (D-M9□E(V)/Y7G/Y7H) are also available. For details, refer to pages 1290 and 1292.



1 Cylinder with Heat Resistant Reed Auto Switch (-10 to 120°C)

Symbol
-X1184

Applicable Series

Description	Model	Action	Note
Standard type	MB	Double acting, Single rod	

How to Order

MDB Standard model no. **Z** – Pivot bracket Rod end bracket – Heat resistant reed auto switch – **X1184**

Switch model ●

Symbol	Description
Nil	Without switch
B30	D-B30
B30J	D-B30J
B31	D-B31
B31J	D-B31J
B35	D-B35
B35J	D-B35J

Number of switches ●

Symbol	Description
S	1 pc.
Nil	2 pcs.
n	n pcs.

Cylinder with heat resistant reed auto switch ●

* Refer to pages 1363 to 1365 for details about the D-B3 auto switch and the Specific Product Precautions.

Specifications

Ambient temperature range	-10°C to 120°C
Bore size	40, 50, 63, 80, 100
Seal material	Fluororubber
Grease	Heat resistant grease

Warning Precautions

Be aware that smoking cigarettes etc. after your hands have come into contact with the grease used in this cylinder can create a gas that is hazardous to humans.

Dimensions (Dimensions other than below are the same as standard type.)

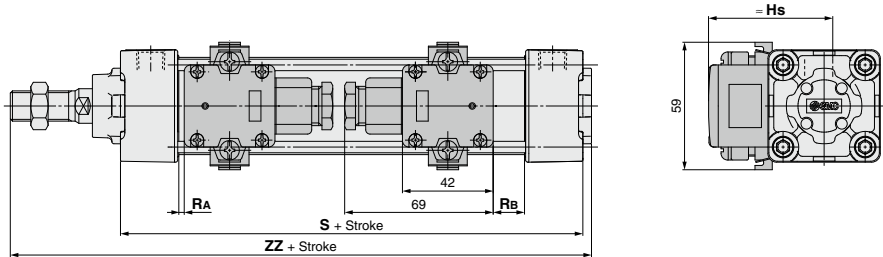

Bore size	S	ZZ	Hs	RA	RB	Minimum mounting stroke		Auto switch mounting bracket part number
						Other than center trunnion	Center trunnion	
40	99	154	57.5	2.5	14.5	1 pc.: 50 st or more	200 st or more	BMB2-040
50	109	171	63	3.5	14.5	2 pcs.: Different surfaces	200 st or more	BMB1-050
63	109	171	69.5	0.5	14.5	50 st or more	200 st or more	BMB1-063
80	129	205	78.5	2.5	22.5	2 pcs.: Same surface	210 st or more	BMB1-080
100	129	205	89	1	22	220 st or more	210 st or more	BMB1-100



MB Series

Specific Product Precautions

Be sure to read this before handling the products. Refer to page 20 for safety instructions and pages 21 to 30 for actuator and auto switch precautions.

Adjustment

Warning

1. Do not open the cushion valve beyond the stopper.

Crimping ($\phi 32$) or a retaining ring ($\phi 40$ to $\phi 100$) is provided to prevent the accidental removal of the cushion valve. Do not open the valve beyond the mechanism. If air is supplied, the cushion valve may shoot out from the cover.

Bore size [mm]	Cushion valve width across flats [mm]	Hexagon wrench
32, 40	2.5	JIS 4648 Hexagonal wrench key 2.5
50, 63	3	JIS 4648 Hexagonal wrench key 3
80, 100, 125	4	JIS 4648 Hexagonal wrench key 4

2. Use the air cushion at the end of cylinder stroke.

Select the cylinder with bumper if the cushion valve is to be fully opened. Otherwise, tie-rods or piston assembly may be damaged.

3. When replacing mounting brackets, use a hexagon wrench.

Bore size [mm]	Bolt	Width across flats [mm]	Tightening torque [N·m]
32, 40	MB-32-48-C1247A	4	5.1
50, 63	MB-50-48-C1249A	5	11
80, 100	Foot MB-80-48AC1251A	6	25
	Others MB-80-48BC1251A		
125	Foot CE00008	8	30.1
	Others CE00032		

4. When replacing mounting brackets, tie-rod nuts on the cylinder body become loosened.

After retightening the tie-rod nuts with the proper tightening torque (Refer to Adjustment 3.), mount a mounting bracket.

5. Do not disassemble the trunnion type cylinder because the mounting precision is required.

It is difficult to align the axial center of the trunnion with the axial center of the cylinder. Thus, if this type of cylinder is disassembled and reassembled, the required dimensional accuracy cannot be attained, which may lead to malfunctions.

With Rod Boot

Handling

Caution

1. Do not turn the piston rod with the rod boot kept locked.

When turning the piston rod, loosen the band once and do not twist the rod boot.

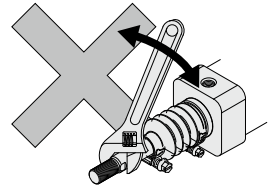

2. Set the breathing hole in the rod boot downward or in the direction that prevents entry of dust or water content.