

# Compact Cylinder/Plate type

## CQU Series

Size: 20, 25, 32, 40

- Width: Reduced by up to **40%**  
(compared with SMC CQ2 series)
- Total length: Reduced by up to **15%**
- Volume: Reduced by up to **18%**
- Weight: Reduced by up to **36%**  
(compared with SMC MU series with 30 stroke)



**Light and compact!**

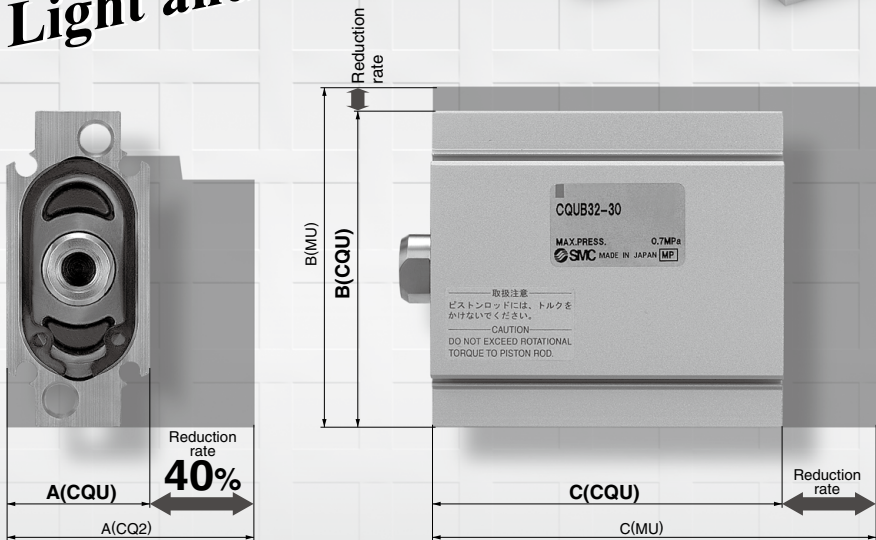

### ● A Dimension Comparison

Size	A (mm)			Reduction rate
	CQU	CQ2	Reduction rate	
20	22	36	39%	
25	24	40	40%	
32	28	45	38%	
40	32	52	38%	

### ● B/C Dimensions Comparison

Size	B (mm)			C (mm)		
	CQU	MU	Reduction rate	CQU	MU	Reduction rate
20	47	—	—	72.5	—	—
25	53	54	2%	72.5	85	15%
32	62	68	9%	79.5	88	10%
40	80	86	7%	79.5	90	12%

### ● Weight Comparison

Size	Weight (g)		
	CQU	MU	Reduction rate
20	153	—	—
25	180	252	29%
32	272	376	28%
40	351	572	36%

\* Compared with 30 stroke.

\* Compared with 30 stroke.

## ● Easy maintenance

Seals can be replaced easily just by removing the retaining rings.

## ● A small type of auto switch can be mounted from 4 directions.

No protrusion of auto switch from the mounting slot

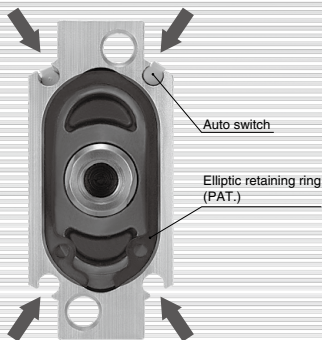

## ● Auto switch can be mounted without removing a support bracket.



## Allows smaller mounting pitch.

+ Without auto switch

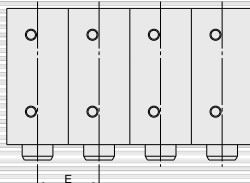

		(mm)	
Size		E	
20		22	
25		24	
32		28	
40		32	

Note 1) Cylinder tube width tolerance:  $\pm 0.2$

Note 2) Minimum mounting pitch of auto switch is specified. Refer to page 1086.

## Mounting

Through-hole/Both ends tapped common



Through-hole/Both ends tapped common (Standard)



Vertical foot

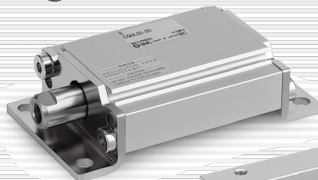

Lateral foot



Double clevis

## Variations

Model	Size	Stroke											Cushion	Mounting	Rod end	
		5	10	15	20	25	30	35	40	45	50	75				100
CQU	20	●	●	●	●	●	●	●	●	●	●	—	—	Rubber bumper	Through-hole/Both ends tapped common (Standard) Vertical foot Lateral foot Double clevis	Male thread Female thread
	25	●	●	●	●	●	●	●	●	●	●	—	—			
	32	●	●	●	●	●	●	●	●	●	●	●	●			
	40	●	●	●	●	●	●	●	●	●	●	●	●			

# Compact Cylinder: Plate Type Double Acting, Single Rod

## CQU Series

Size: 20, 25, 32, 40

### How to Order

CQU **B** **20** - **30** - **M9BW**

#### Mounting

<b>B</b>	Through-hole/Both ends tapped common (Standard)
<b>L</b>	Vertical foot
<b>M</b>	Lateral foot
<b>D</b>	Double clevis

- \* Support brackets are shipped together, (but not assembled).
  - \* Cylinder mounting bolt is not included.
- Order it separately from "Mounting Bolt for CQU" on page 1079.

#### Number of auto switches

<b>Nil</b>	2 pcs.
<b>S</b>	1 pc.
<b>n</b>	"n" pcs.

#### Auto switch

<b>Nil</b>	Without auto switch (Built-in magnet)
------------	---------------------------------------

- \* For applicable auto switch models, refer to the table below.

#### Size

<b>20</b>	Piston area equivalent to 20 mm
<b>25</b>	Piston area equivalent to 25 mm
<b>32</b>	Piston area equivalent to 32 mm
<b>40</b>	Piston area equivalent to 40 mm

#### Rod end thread

<b>Nil</b>	Rod end female thread
<b>M</b>	Rod end male thread

#### Cylinder stroke (mm)

Size	Stroke
<b>20, 25</b>	5, 10, 15, 20, 25, 30, 35, 40, 45, 50
<b>32, 40</b>	5, 10, 15, 20, 25, 30, 35, 40, 45, 50, 75, 100

### Applicable Auto Switches

Refer to pages 1271 through to 1365 for further information on auto switches.

Type	Special function	Electrical entry	Indicator light	Wiring (Output)	Load voltage		Auto switch model		Lead wire length (m)			Pre-wired connector	Applicable load		
					DC	AC	Perpendicular	In-line	0.5 (Nil)	1 (M)	3 (L)		5 (Z)		
Solid state auto switch	—	Grommet	Yes	3-wire (NPN)	24 V	5 V, 12 V	—	<b>M9NV</b>	<b>M9N</b>	●	●	○	○	IC circuit	Relay, PLC
				3-wire (PNP)				<b>M9PV</b>	<b>M9P</b>	●	●	○	○		
				2-wire				<b>M9BV</b>	<b>M9B</b>	●	●	○	○		
	3-wire (NPN)			5 V, 12 V	<b>M9NWW</b>	<b>M9NW</b>	●	●	○	○	IC circuit				
	3-wire (PNP)				<b>M9PWW</b>	<b>M9PW</b>	●	●	○	○					
	2-wire				<b>M9BWW</b>	<b>M9BW</b>	●	●	○	○					
	Water resistant (2-color indicator)	Grommet	Yes	3-wire (NPN)	24 V	5 V, 12 V	—	<b>M9NAV<sup>*1</sup></b>	<b>M9NA<sup>*1</sup></b>	○	○	○	○	IC circuit	
				3-wire (PNP)				<b>M9PAV<sup>*1</sup></b>	<b>M9PA<sup>*1</sup></b>	○	○	○	○		
				2-wire				<b>M9BAV<sup>*1</sup></b>	<b>M9BA<sup>*1</sup></b>	○	○	○	○		
Reed auto switch	—	Grommet	Yes	3-wire (NPN equivalent)	24 V	12 V	100 V 100 V or less	<b>A96V</b>	<b>A96</b>	●	●	—	—	IC circuit	—
				<b>A93V<sup>*2</sup></b>				<b>A93</b>	●	●	●	—	—	Relay, PLC	
				<b>A90V</b>				<b>A90</b>	●	—	—	—	—	IC circuit	

- \*1 The water resistant improved D-M9□CA and M9□AV type can be mounted, but cylinders are not designed to be water resistant improved construction.
- \*2 1 m type lead wire is only applicable to D-A93.

- \* Lead wire length symbols: 0.5 m ..... Nil (Example) M9NV  
1 m ..... M (Example) M9NWM  
3 m ..... L (Example) M9NWL  
5 m ..... Z (Example) M9NZZ
- \* Solid state switches marked with "○" are produced upon receipt of order.

- \* For details about the auto switch with pre-wired connector, refer to pages 1340 and 1341.
- \* Auto switches are shipped together, (but not assembled).

Note) The D-M9□V, M9□WV, M9□AV, and A9□V type cannot be mounted on the port surface depending on the cylinder's stroke and the fitting size for piping. Please confirm SMC separately.



## Symbol

Rubber bumper (Non-circular piston)

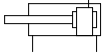

## Specifications

Equivalent bore size (mm)	<b>20</b>	<b>25</b>	<b>32</b>	<b>40</b>
Action	Double acting, Single rod			
Fluid	Air			
Proof pressure	1.0 MPa			
Maximum operating pressure	0.7 MPa			
Minimum operating pressure	0.08 MPa	0.05 MPa		
Ambient and fluid temperature	Without auto switch: -10 to 70°C (No freezing)			
	With auto switch: -10 to 60°C (No freezing)			
Cushion	Rubber bumper			
Rod end thread	Female thread, Male thread			
Stroke length tolerance	$\begin{matrix} +1.4 \\ 0 \end{matrix}$			
Mounting	Through-hole/Both ends tapped common			
Piston speed	50 to 500 mm/s			

\* The stroke length tolerance does not include the changed amount of the rubber bumper due to compression.

## Theoretical Output

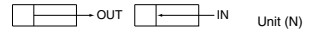

Size	Rod size (mm)	Operating direction	Piston area (mm <sup>2</sup> )	Operating pressure (MPa)		
				0.3	0.5	0.7
<b>20</b>	10	IN	236	71	118	165
		OUT	314	94	157	220
<b>25</b>	10	IN	412	124	206	288
		OUT	491	147	246	344
<b>32</b>	14	IN	650	195	325	455
		OUT	804	241	402	563
<b>40</b>	14	IN	1103	331	552	772
		OUT	1256	377	628	879

## Standard Stroke

Unit (mm)

Size	Standard stroke
<b>20, 25</b>	5, 10, 15, 20, 25, 30, 35, 40, 45, 50
<b>32, 40</b>	5, 10, 15, 20, 25, 30, 35, 40, 45, 50, 75, 100

\* Other intermediate strokes can be manufactured upon receipt of order. Please contact SMC.

## Support Bracket Part No.

Size	Vertical foot <sup>Note 1)</sup>		Lateral foot		Double clevis
	Rod end	Head end	Rod end	Head end	
<b>20</b>	CQU-LR20	CQU-LH20	CQU-MR20	CQU-MH20	CQU-D20
<b>25</b>	CQU-L25		CQU-M25		CQU-D25
<b>32</b>	CQU-L32		CQU-M32		CQU-D32
<b>40</b>	CQU-L40		CQU-M40		CQU-D40

Note 1) When ordering a foot bracket of size 20, check which end, rod end or head end, it will be on. For other sizes, the part number is common to both ends.

Note 2) Parts belonging to each bracket are as follows.

Vertical foot, Lateral foot: Body mounting bolt

Double clevis: Clevis pin, C-type retaining ring for shaft, Body mounting bolt

**Weight**

Unit (g)

Size	Cylinder stroke (mm)											
	5	10	15	20	25	30	35	40	45	50	75	100
<b>20</b>	105	115	125	134	144	153	163	173	182	192	—	—
<b>25</b>	127	138	148	159	169	180	190	201	211	222	—	—
<b>32</b>	199	214	228	243	257	272	286	301	315	330	402	475
<b>40</b>	264	282	299	316	333	351	368	385	403	420	506	593

**Additional Weight**

Unit (g)

Size		20	25	32	40
Rod end male thread	Male thread	19	19	32	32
	Nut	4	4	10	10
Vertical foot (Including mounting bolt)		84	91	122	162
Lateral foot (Including mounting bolt)		105	113	145	203
Double clevis (Including pin, retaining ring, mounting bolt)		60	76	149	266

**How to Calculate**

(Example) **CQUD32-50M**

- Basic weight: CQUB32-50.....330 g
  - Additional weight: Rod end male thread..... 42 g
  - Double clevis ..... 149 g
- 
- 521 g

**Mounting Bolt for CQU**

**How to Mount:** Use this bolt for mounting into a through-hole. Refer to the following for ordering procedures. Order the actual number of bolts that will be used.

**Example) CQ-M5 x 55L 2 pcs.**

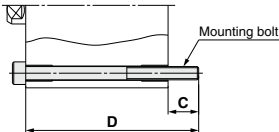

(mm)

Cylinder model	C	D	Mounting bolt part no.
<b>CQUB20-5</b>	7.5	55	CQ-M5 x 55L
<b>-10</b>		60	x 60L
<b>-15</b>		65	x 65L
<b>-20</b>		70	x 70L
<b>-25</b>		75	x 75L
<b>-30</b>		80	x 80L
<b>-35</b>		85	x 85L
<b>-40</b>		90	x 90L
<b>-45</b>		95	x 95L
<b>-50</b>		100	x 100L

(mm)

Cylinder model	C	D	Mounting bolt part no.
<b>CQUB25-5</b>	7.5	55	CQ-M5 x 55L
<b>-10</b>		60	x 60L
<b>-15</b>		65	x 65L
<b>-20</b>		70	x 70L
<b>-25</b>		75	x 75L
<b>-30</b>		80	x 80L
<b>-35</b>		85	x 85L
<b>-40</b>		90	x 90L
<b>-45</b>		95	x 95L
<b>-50</b>		100	x 100L

(mm)

Cylinder model	C	D	Mounting bolt part no.
<b>CQUB32-5</b>	10.5	65	CQ-M5 x 65L
<b>-10</b>		70	x 70L
<b>-15</b>		75	x 75L
<b>-20</b>		80	x 80L
<b>-25</b>		85	x 85L
<b>-30</b>		90	x 90L
<b>-35</b>		95	x 95L
<b>-40</b>		100	x 100L
<b>-45</b>		105	x 105L
<b>-50</b>		110	x 110L
<b>-75</b>		135	x 135L
<b>-100</b>		160	x 160L

(mm)

Cylinder model	C	D	Mounting bolt part no.
<b>CQUB40-5</b>	10.5	65	CQ-M5 x 65L
<b>-10</b>		70	x 70L
<b>-15</b>		75	x 75L
<b>-20</b>		80	x 80L
<b>-25</b>		85	x 85L
<b>-30</b>		90	x 90L
<b>-35</b>		95	x 95L
<b>-40</b>		100	x 100L
<b>-45</b>		105	x 105L
<b>-50</b>		110	x 110L
<b>-75</b>		135	x 135L
<b>-100</b>		160	x 160L

Material: Chromium molybdenum steel Surface treatment: Zinc chromated

## Allowable Kinetic Energy

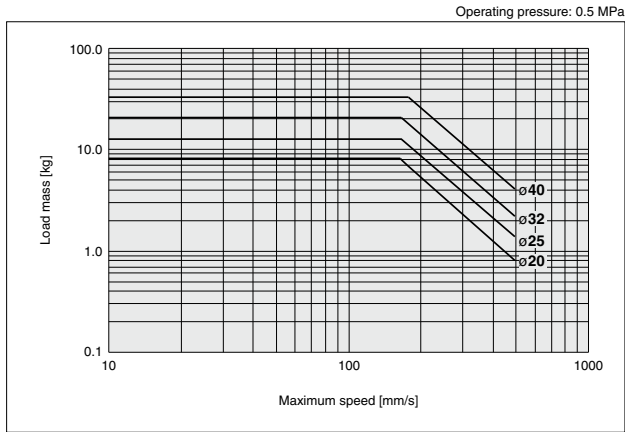

## Allowable Rod End Lateral Load

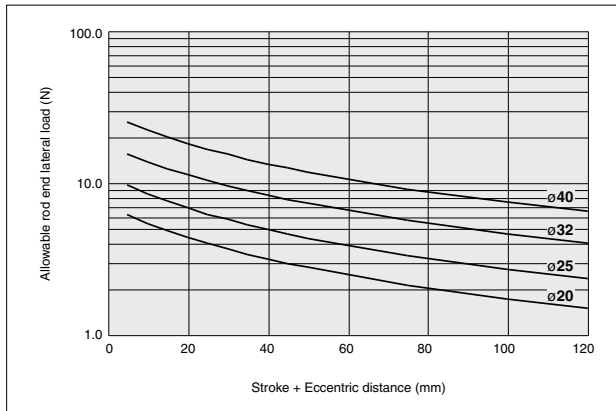
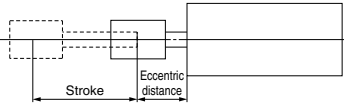

Allowable rod end lateral load can be found from the above graph. Do not apply a load beyond the line on the graph.

## Construction

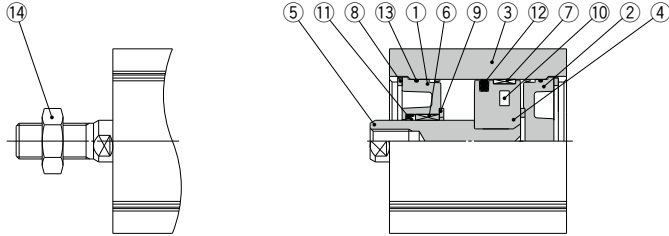

Rod end male thread

### Component Parts

No.	Description	Material	Note
1	Rod cover	Aluminum die-casted	Chromated
2	Head cover	Aluminum die-casted	Chromated
3	Cylinder tube	Aluminum alloy	Hard anodized
4	Piston	Aluminum die-casted	Chromated
5	Piston rod	Stainless steel	ø20, ø25
		Carbon steel	ø32, ø40, Hard chrome plated
6	Bushing	Bearing alloy	
7	Wear ring	Fluoropolymer	
8*	N-type retaining ring	Carbon tool steel	Phosphate treatment
9	Bumper	Urethane	
10	Magnet	—	
11*	Rod seal	NBR	
12**	Piston seal	NBR	
13*	O-ring	NBR	
14	Rod end nut	Carbon steel	Chromated

### Replacement Parts: Seal Kit

Size	Kit no.	Contents
20	CQUB20-PS	Set of component parts ⑧, ⑪, ⑫, ⑬
25	CQUB25-PS	
32	CQUB32-PS	
40	CQUB40-PS	

\* Seal kit includes ⑧, ⑪, ⑫, ⑬. Order the seal kit, based on each size.

\*\* Seal kit does not include a grease package. Order it separately.

\* Grease package part number: GR-S-010 (10 g)

## Dimensions

\* For auto switch mounting position and its mounting height, refer to page 1085.

### Basic (Through-hole/Both ends tapped common): CQUB

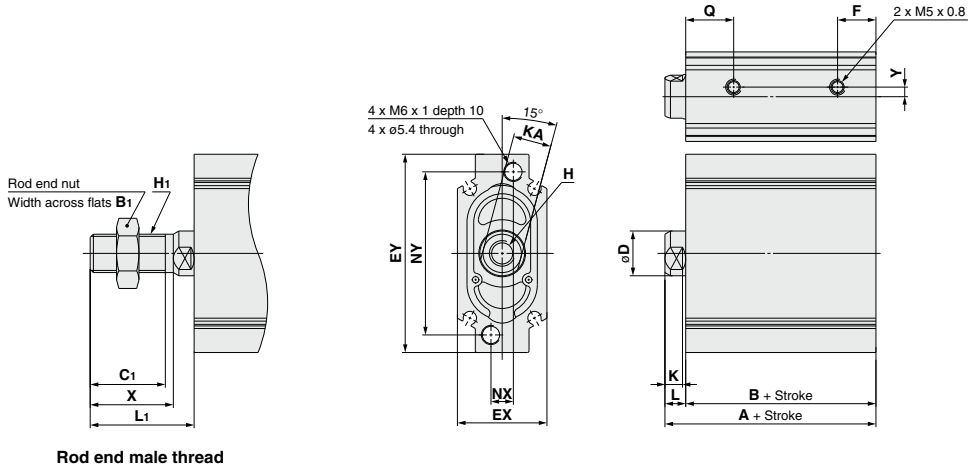

Rod end male thread

### Basic

(mm)

Size	Stroke range (mm)	A	B	D	EX	EY	F	H	K	KA	L	NX	NY	Q	Y
20	5 to 50	49	42.5	10	22	47	11.5	M5 x 0.8 depth 8	5	8	6.5	5.5	36	15	3
25	5 to 50	49	42.5	10	24	53	11	M5 x 0.8 depth 8	5	8	6.5	5	41	14.5	4
32	5 to 100	56	49.5	14	28	62	12	M8 x 1.25 depth 13	6	12	6.5	7	51	15	3
40	5 to 100	56	49.5	14	31	80	12	M8 x 1.25 depth 13	6	12	6.5	7	69	15	3

### Rod End Male Thread

(mm)

Size	X	C <sub>1</sub>	B <sub>1</sub>	L <sub>1</sub>	H <sub>1</sub>
20	18	15.5	13	24.5	M8 x 1.25
25	18	15.5	13	24.5	M8 x 1.25
32	26	23.5	19	32.5	M12 x 1.25
40	26	23.5	19	32.5	M12 x 1.25

\* For details about the rod end nut, refer to page 1084.



## Dimensions

### Vertical foot: CQUL

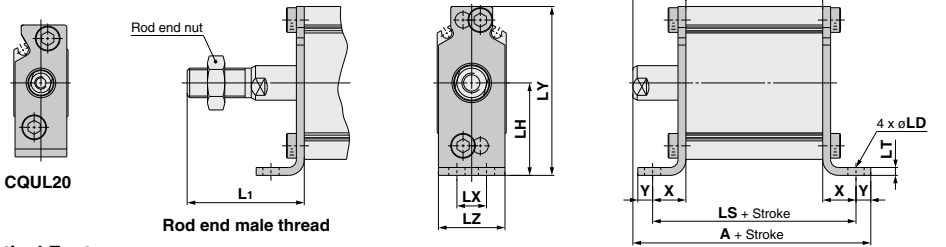

### Vertical Foot

Size	Stroke range	A	B	L	L <sub>1</sub>	LD	LH	LS	LT	LX	LY	LZ	X	Y
20	5 to 50	82.5	42.5	21.5	39.5	6	30	67.5	3.2	11	53.5	21	12.5	6
25	5 to 50	82.5	42.5	21.5	39.5	6	32.5	67.5	3.2	11	59	23	12.5	6
32	5 to 100	90.5	49.5	21.5	47.5	7	37.5	76.5	3.2	12	68.5	27	13.5	6
40	5 to 100	99	49.5	26.5	52.5	9	46.5	79.5	3.2	15	86.5	30	15	8

Vertical foot bracket material: Carbon steel  
Surface treatment: Nickel plated

### Lateral foot: CQUM

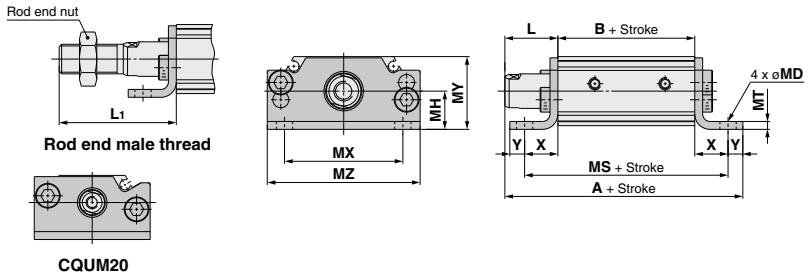

### Lateral Foot

Size	Stroke range	A	B	L	L <sub>1</sub>	MD	MH	MS	MT	MX	MY	MZ	X	Y
20	5 to 50	82.5	42.5	21.5	39.5	6	15	67.5	3.2	36	26	47	12.5	6
25	5 to 50	82.5	42.5	21.5	39.5	6	14.5	67.5	3.2	42	26.5	53	12.5	6
32	5 to 100	90.5	49.5	21.5	47.5	7	15.5	76.5	3.2	48	29.5	62	13.5	6
40	5 to 100	99	49.5	26.5	52.5	9	16.5	79.5	3.2	63	32	80	15	8

Lateral foot bracket material: Carbon steel  
Surface treatment: Nickel plated

### Double clevis: CQUD

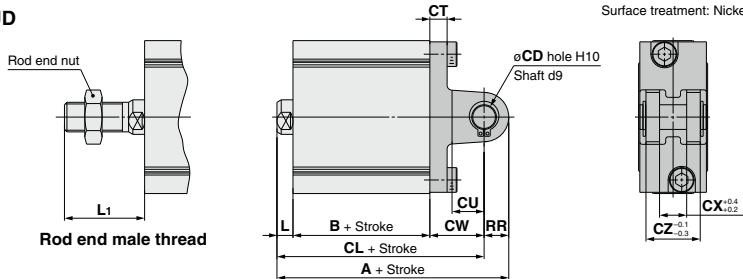

### Double Clevis

Size	Stroke range	A	B	CD	CL	CT	CU	CW	CX	CZ	L	L <sub>1</sub>	RR
20	5 to 50	72	42.5	8	64	4	9	15	8	16	6.5	24.5	8
25	5 to 50	74	42.5	8	66	4	11	17	9	18	6.5	24.5	8
32	5 to 100	88	49.5	10	78	7	13	22	11	22	6.5	32.5	10
40	5 to 100	93	49.5	10	83	10	13	27	13	26	6.5	32.5	10

\* For details about the rod end nut and accessory brackets, refer to page 1084.

Double clevis bracket material: Carbon steel  
Surface treatment: Metallic painted

# CQU Series Accessory Brackets

## Single Knuckle Joint

CQU20,  
CQU25

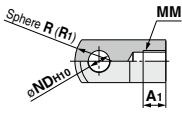

CQU32,  
CQU40

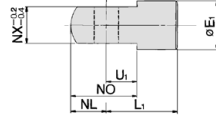
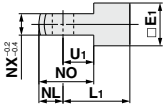
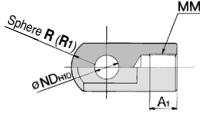

(mm)

Part no.	Size	A1	E1	L1	MM
I-G02	20, 25	8.5	16	25	M8 x 1.25
I-MU03	32, 40	12	18	31	M12 x 1.25

Part no.	NDH10	NL	NO	NX	R1	U1
I-G02	$8^{+0.058}_0$	9	20.5	8	10.3	11.5
I-MU03	$10^{+0.058}_0$	10	24	11	10	14

Single knuckle joint material: Rolled steel  
Surface treatment: Nickel plated

## Double Knuckle Joint

CQU20,  
CQU25

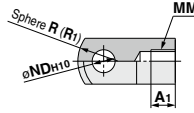

CQU32,  
CQU40

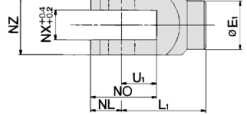
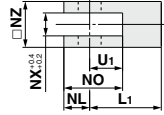
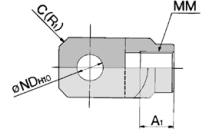

(mm)

Part no.	Size	A1	E1	L1	MM	NDH10
Y-G02	20, 25	8.5	—	25	M8 x 1.25	$8^{+0.058}_0$
Y-MU03	32, 40	12	18	31	M12 x 1.25	$10^{+0.058}_0$

Part no.	NL	NO	NX	NZ	R1	U1
Y-G02	9	20.5	8	16	10.3	11.5
Y-MU03	10	24	11	22	4	14

\* Knuckle pin and retaining ring are included. Double knuckle joint material: Rolled steel  
Surface treatment: Nickel plated (Y-G02)  
Chromated (Y-MU03)

## Knuckle Pin (Common with Double Clevis Pin)

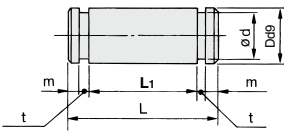

(mm)

Part no.	Size	Dd9	L	d	L1
IY-G02	20	$8^{+0.040}_{-0.076}$	21	7.6	16.2
CD-MU02	25	$8^{+0.040}_{-0.076}$	23	7.6	18.2
CD-MU03	32	$10^{+0.040}_{-0.076}$	27	9.6	22.2
CD-MU04	40	$10^{+0.040}_{-0.076}$	31	9.6	26.2

Part no.	m	t	Applicable retaining ring
IY-G02	1.5	0.9	C-type 8 for shaft
CD-MU02	1.5	0.9	C-type 8 for shaft
CD-MU03	1.25	1.15	C-type 10 for shaft
CD-MU04	1.25	1.15	C-type 10 for shaft

Pin material: Carbon steel

\* Knuckle pin is included in the double clevis and double knuckle joint as standard.  
\* C-type retaining ring for shaft is included.

## Rod End Nut

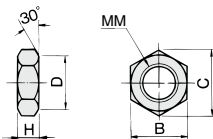

(mm)

Part no.	Size	MM	H	B	C	D
NT-02	20, 25	M8 x 1.25	5	13	15.0	12.5
NT-MU03	32, 40	M12 x 1.25	7	19	21.9	18

\* A nut is included in the rod end  
Rod end nut material: Carbon steel  
Surface treatment: Chromated

## Double Clevis Socket

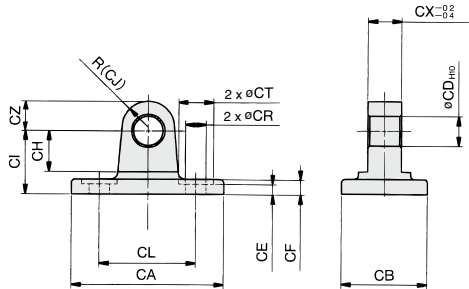

(mm)

Part no.	Size	CA	CB	CDH10	CE	CF	CH	CI	CJ
MU-C02	25	53	23	$8^{+0.058}_0$	3.5	4	11	17	7
MU-C03	32	67	27	$10^{+0.058}_0$	3.5	7	13	22	10
MU-C04	40	85	31	$10^{+0.058}_0$	3.5	10	13	27	10

Part no.	CL	CR	CT	CX	CZ
MU-C02	26	5.3	9.5	9	8
MU-C03	42	6.4	11	11	10
MU-C04	54	8.4	14	13	10

Double clevis socket material:

Cast iron

Surface treatment: Painted

Note) Double clevis socket is available for sizes from 25 to 40.

# CQU Series Auto Switch Mounting

## Auto Switch Proper Mounting Position (Stroke End Detection) and Its Mounting Height

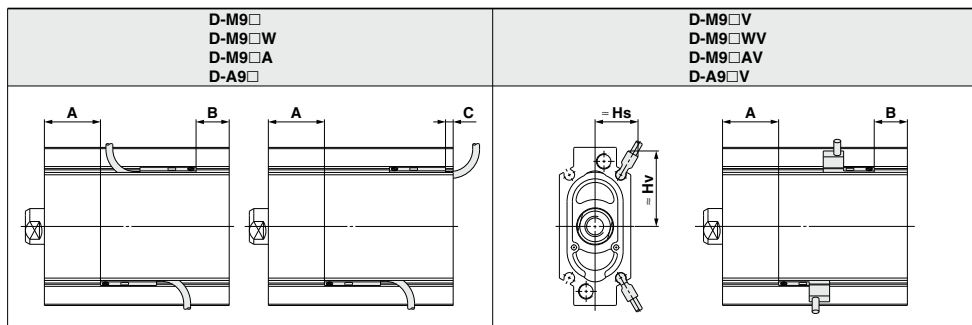

Size	D-M9□ D-M9□W D-M9□A			D-M9□V D-M9□WV D-M9□AV				D-A9□			D-A9□V			
	A	B	C	A	B	Hs	Hv	A	B	C	A	B	Hs	Hv
20	19	11.5	1.5	19	11.5	14	23	15	7.5	5.5 (3)	15	7.5	12.5	20.5
25	19	11.5	1.5	19	11.5	15.5	25	15	7.5	5.5 (3)	15	7.5	14	23
32	22	15	5	22	15	17	30	18.5	11	9 (6.5)	18.5	11	15.5	27.5
40	22	15	5	22	15	17.5	37.5	18.5	11	9 (6.5)	18.5	11	16.5	35

(mm)

( ) : D-A93

\* For actual setting, check the operation of the auto switch and adjust as necessary.

## Minimum Stroke for Auto Switch Mounting

Number of auto switches	D-M9□ D-M9□V D-M9□W D-M9□A D-M9□V		D-M9□W D-M9□WV D-M9□A D-M9□AV	
1 pc.	5		10	
2 pcs.	10		15	

(mm)

## Auto Switch Mounting

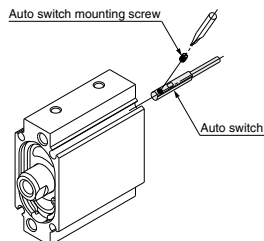

Use a watchmaker's screwdriver with a grip diameter of 5 to 6 mm to tighten the auto switch mounting screw.

### Tightening torque for auto switch mounting screw (N·m)

Auto switch model	Tightening torque
D-M9□(V) D-M9□W(V) D-A93	0.05 to 0.15
D-M9□A(V)	0.05 to 0.10
D-A9□(V) (Excludes the D-A93)	0.10 to 0.20

## Operating Range

Auto switch model	Size			
	20	25	32	40
D-M9□/M9□V (Note)	2	2	2	2
D-M9□W/M9□WV D-M9□A/M9□AV	3	3	3.5	3
D-A9□/A9□V	6.5	6	6	5.5

(mm)

\* Since this is a guideline including hysteresis, not meant to be guaranteed. (Assuming approximately ±30% dispersion) Value may greatly change depending on the surrounding environment.

Note) In products delivered from August 2008 onwards, the value will be the same as the D-M9□W, M9□WV, M9□A, and M9□AV.



# CQU Series

## Specific Product Precautions

Be sure to read this before handling the products.

Refer to page 20 for safety instructions and pages 21 to 30 for actuator and auto switch precautions.

### Precautions

#### ⚠ Caution

- All loads to piston rod must be applied in axial direction only.
  - When a lateral load is applied unavoidably, ensure that it should not exceed the allowable lateral load to the rod end as specified on page 1080.
  - When installing a cylinder, centering should be required accurately.
  - Adoption of guide mechanism is strongly recommended for the case when the CQU is used as stopper to prevent non-rotating piston rod from side loads.
- When securing a workpiece to the end of the piston rod, ensure that the piston rod is retracted entirely, and tighten using the width across flats on the rod end, making sure to avoid the application of rotational torque on the piston rod.

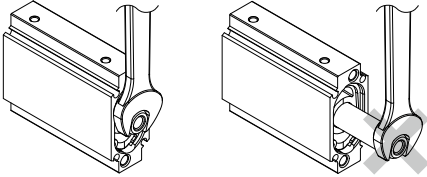

- Operating the cylinder by connecting the piping directly to the cylinder can cause the piston speed to exceed the maximum operating speed of 500 mm/s. Therefore, to operate the cylinder, make sure to use an SMC speed controller and adjust the piston speed to 500 mm/s or less.

### Retaining Ring Installation/Removal

#### ⚠ Caution

- For installation and removal, use an appropriate pair of pliers (tool for installing a C-type retaining ring).
- Even if a proper plier (tool for installing a C-type retaining ring) is used, it is likely to inflict damage to a human body or peripheral equipment, as a retaining ring may be flown out of the tip of a plier (tool for installing a C-type retaining ring). Be much careful with the popping of a retaining ring. Besides, be certain that a retaining ring is placed firmly into the groove of rod cover before supplying air at the time of installment.
- Do not reuse the retaining ring once it has been removed. (The retaining ring is included in the seal kit.)

### SMC Logo

#### ⚠ Caution

- The direction of the SMC logo on the end face of the head cover is not specified in relation to the port position.

### Handing of Auto Switches

#### ⚠ Warning

- If multiple cylinders are operated adjacent to each other, the magnets that are enclosed in the adjacent cylinders could affect the operation of the auto switches, causing the switches to malfunction. Therefore, make sure that the mounting pitch of the cylinders is at least that indicated in the table below.

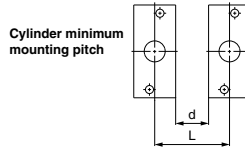

Size	20	25	32	40
L	30	29	33	36
d	8	5	5	5

- If the cylinder is used in an application in which a magnetic material is placed in close contact around the cylinder as shown in the graph below (including cases in which even one of the sides is in close contact) the operation of auto switches could become unstable. Therefore, please check with SMC for this type of application.

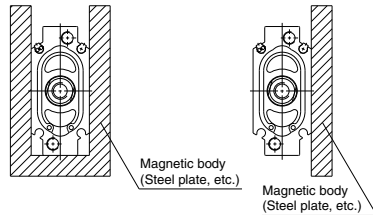

- When multiple cylinders are installed close together and an auto switch with perpendicular entry for lead wire is used, the auto switch will protrude from the end of the tube, so take care to avoid interference. (Refer to page 1085.)

