

# Electric Actuators

High Performance

## Slider Type/Rod Type

Incremental (Step Motor 24 VDC)

# Reduces cycle time

## Cycle time

**LEFS□F** Reduced by **39%** (0.57 s ← 0.93 s) compared with the existing model\*<sup>1</sup>

\*<sup>1</sup> When LEFS25FH-400 is operated from 0 to 400 mm (stroke)

**LEY□F** Reduced by **44%** (0.54 s ← 0.97 s) compared with the existing model\*<sup>2</sup>

\*<sup>2</sup> When LEY25FA-300 is operated from 0 to 300 mm (stroke)

New

A rod type has been added.

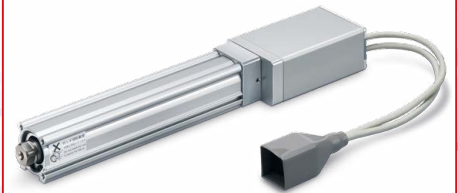

LEY□F Series

## Acceleration/Deceleration

**10000 mm/s<sup>2</sup>** (334% increase compared with the existing model)

## Max. speed

**LEFS□F** **1500 mm/s** (Improved by **25%** compared with the existing model)

**LEY□F** **800 mm/s** (Improved by **60%** compared with the existing model)

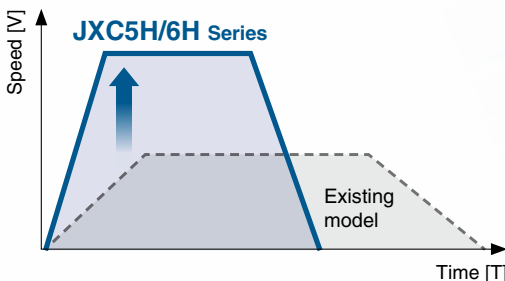

## High Performance Step Motor Controller

Higher acceleration and max. speed can be set with the special controller.

Parallel I/O

JXC5H/6H Series p. 61



EtherCAT/EtherNet/IP™/PROFINET

JXCEH/9H/PH Series p. 68



# LEFS□F/LEY□F Series





**ACT 2**

**Controller Setting Software ACT Controller 2**

**Easy-to-use setting software ACT Controller 2 (For PC)**

**Various functions available in normal mode** (Compared with the existing ACT Controller)

● **Parameter and step data setting**

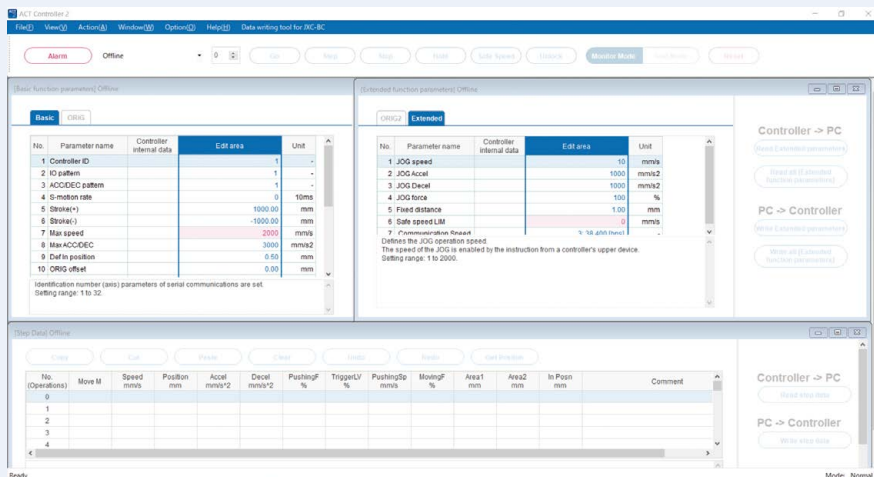

\* Customers operating computers with specifications other than Windows 10/64 bit and Windows 11 should use the existing ACT Controller.

● **Alarm confirmation**

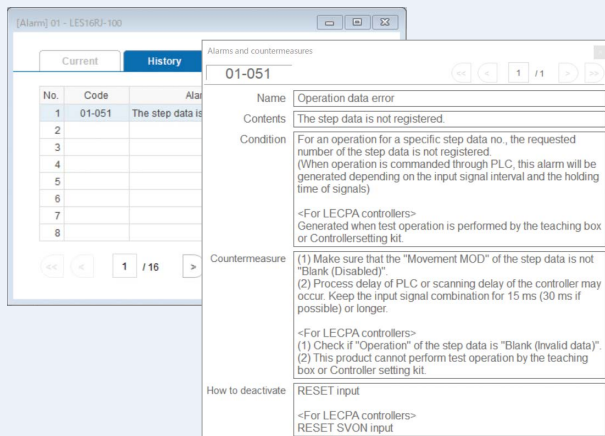

When an alarm is generated, the alarm details and countermeasures can be confirmed.

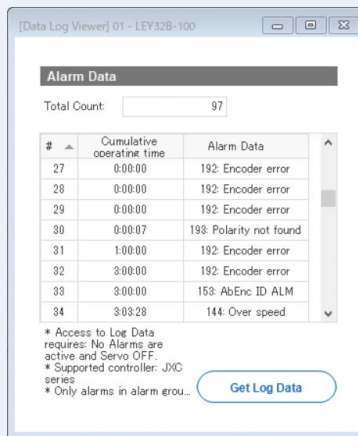

When an alarm is generated, the cumulative start-up time of the controller can be confirmed.

● **Waveform monitoring**

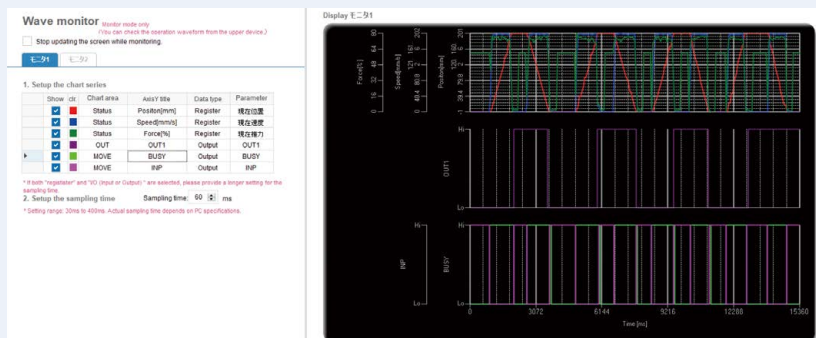

The position, speed, force, and input/output signals' waveform data during operation can be measured.

\* When using the ACT Controller 2 test operation function, waveform monitoring is not available.

Step Data Input Type JXC5H/6H Series **p. 61**



**ACT 2**

**Controller Setting Software ACT Controller 2**

• **The JXC-BC writing tool**

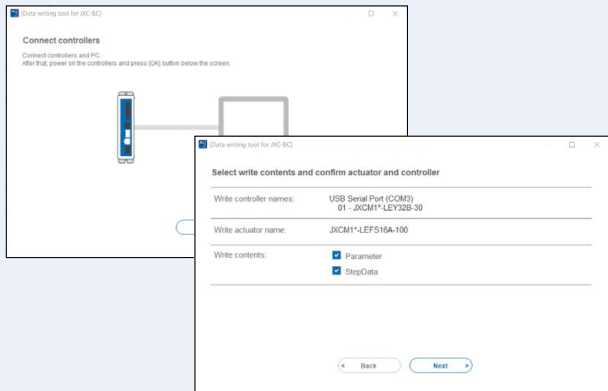

The writing tool can be used to write the connected actuator's parameters and step data to a JXC series blank controller.

• **Customizable plug-in functions**

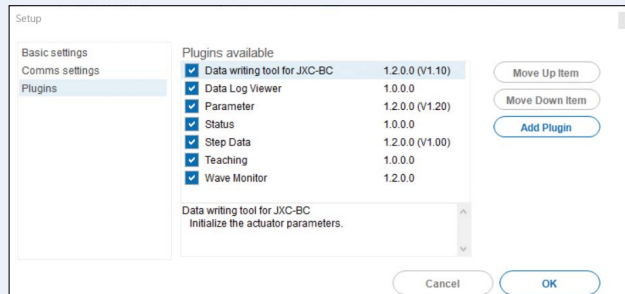

Which plug-in functions are displayed as well as the display order are customizable. Customers can add the functions they require.

In normal mode, various other test operation methods (program operation, jogging, moving of the constant rate, etc.), signal status monitoring, one-touch switching between Japanese and English, and other functions are available.

**For immediate use, operate in easy mode.**

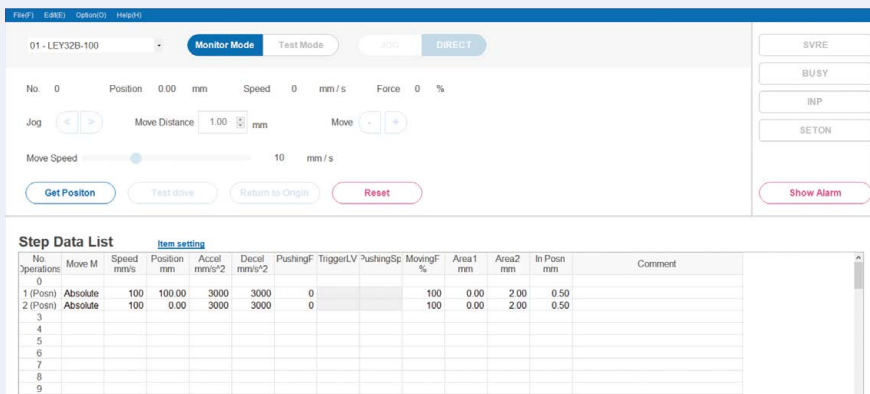

Step data setting, various test operations, and status confirmation can be done on a single screen.

**How to download the setting software**

[Click here for details.](#)

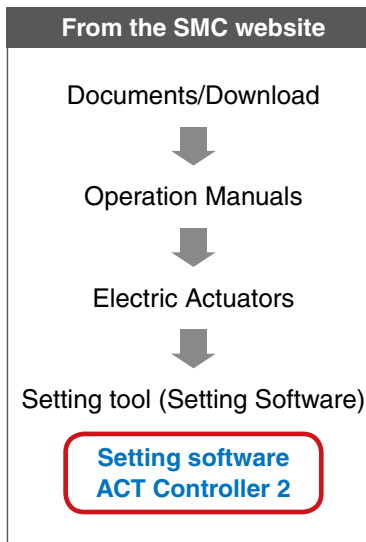
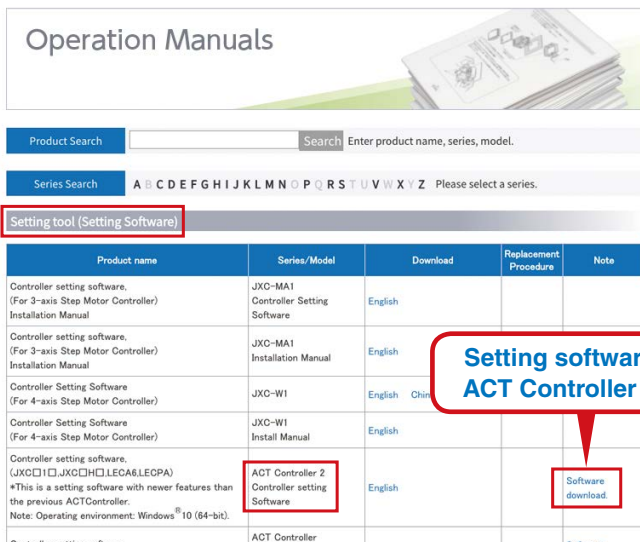

**Step Data Input Type JXC5H/6H Series** p. 61



**Teaching Box**

◎ **Normal Mode**

- Multiple step data can be stored in the teaching box and transferred to the controller.
- Continuous test drive by up to 5 step data

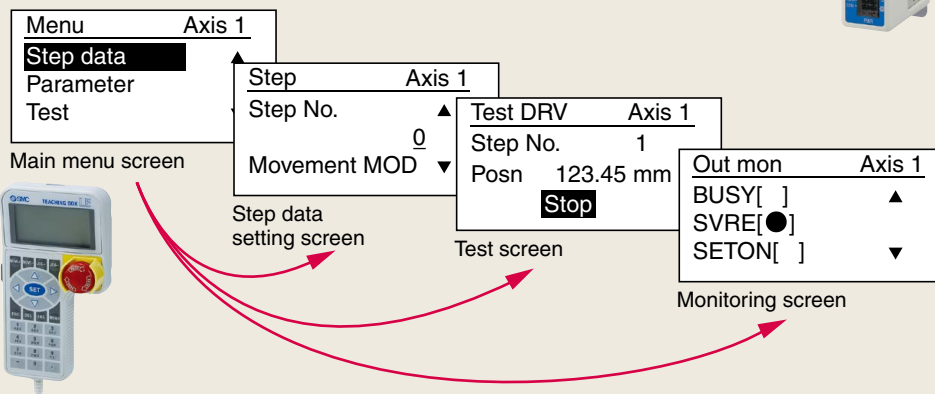

**Teaching box screen**

- Each function (step data setting, test drive, monitoring, etc.) can be selected from the main menu.

◎ **Easy Mode**

- The simple screen without scrolling promotes ease of setting and operation.
- Choose an icon from the first screen to select a function.
- Set the step data and check the monitor on the second screen.



**Example of setting the step data**

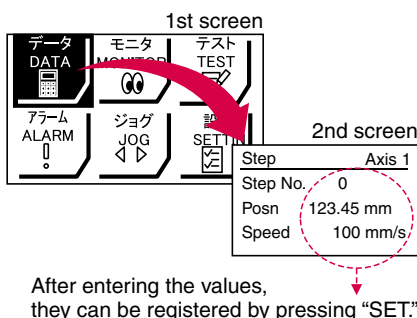

**Example of checking the operation status**

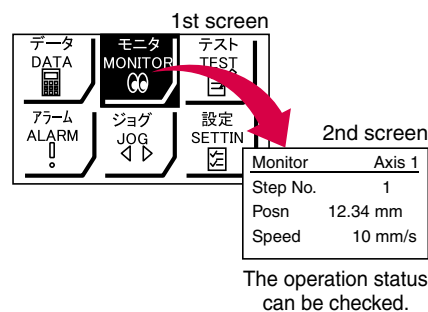

**Teaching box screen**

- Data can be set by inputting only the position and speed. (Other conditions are preset.)

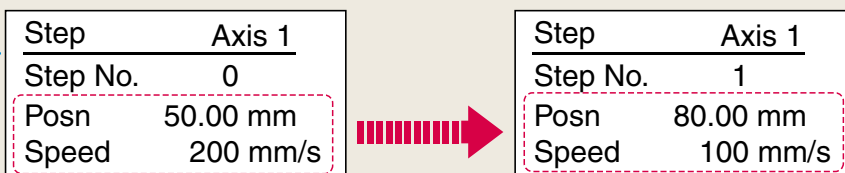

**The actuator and controller are provided as a set.** (They can be ordered separately as well.)

Confirm that the combination of the controller and actuator is correct.

<Check the following before use.>

- ① Check the actuator label for the model number. This number should match that of the controller.
- ② Check that the Parallel I/O configuration matches (NPN or PNP).

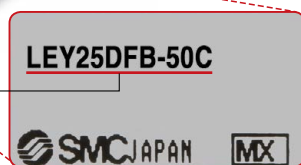
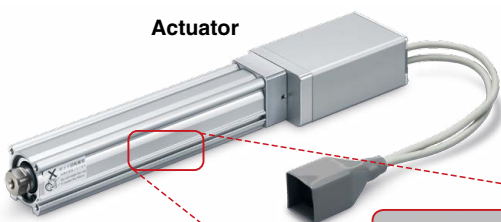

**Controller**



## Function

Item	Step data input type JXC5H/6H
Step data and parameter setting	<ul style="list-style-type: none"> <li>Input from controller setting software (PC)</li> <li>Input from teaching box</li> </ul>
Step data “position” setting	<ul style="list-style-type: none"> <li>Numerical value input from controller setting software (PC) or teaching box</li> <li>Input numerical value</li> <li>Direct teaching</li> <li>JOG teaching</li> </ul>
Number of step data	64 points
Operation command (I/O signal)	Step No. [IN <sup>+</sup> ] input ⇒ [DRIVE] input
Completion signal	[INP] output

## Setting Items

TB: Teaching box PC: Controller setting software

Item	Contents	Easy Mode		Normal Mode	Step data input type JXC5H/6H	
		TB	PC	TB/PC		
Step data setting (Excerpt)	Movement MOD	Selection of “absolute position” and “relative position”	△	●	●	Set at ABS/INC
	Speed	Transfer speed	●	●	●	Set in units of 1 mm/s
	Position	[Position]: Target position [Pushing]: Pushing start position*1	●	●	●	Set in units of 0.01 mm
	Acceleration/Deceleration	Acceleration/deceleration during movement	●	●	●	Set in units of 1 mm/s <sup>2</sup>
	Pushing force	Rate of force during pushing operation*1	●	●	●	Set in units of 1%
	Trigger LV	Target force during pushing operation*1	△	●	●	Set in units of 1%
	Pushing speed	Speed during pushing operation*1	△	●	●	Set in units of 1 mm/s
	Moving force	Force during positioning operation	△	●	●	Set to 100%
	Area output	Conditions for area output signal to turn ON	△	●	●	Set in units of 0.01 mm
	In position	[Position]: Width to the target position [Pushing]: How much it moves during pushing	△	●	●	Set to 0.5 mm or more (Units: 0.01 mm)
Parameter setting (Excerpt)	Stroke (+)	+ side position limit	×	×	●	Set in units of 0.01 mm
	Stroke (-)	- side position limit	×	×	●	Set in units of 0.01 mm
	ORIG direction	Direction of the return to origin can be set.	×	×	●	Compatible
	ORIG speed	Speed during return to origin	×	×	●	Set in units of 1 mm/s
	ORIG ACC	Acceleration during return to origin	×	×	●	Set in units of 1 mm/s <sup>2</sup>
Test	JOG		●	●	●	Continuous operation at the set speed can be tested while the switch is being pressed.
	MOVE		×	●	●	Operation at the set distance and speed from the current position can be tested.
	Return to ORIG		●	●	●	Compatible
	Test drive	Operation of the specified step data	●	●	● (Continuous operation)	Compatible
	Forced output	ON/OFF of the output terminal can be tested.	×	×	●	Compatible
Monitor	DRV mon	Current position, speed, force, and the specified step data can be monitored.	●	●	●	Compatible
	In/Out mon	Current ON/OFF status of the input and output terminal can be monitored.	×	×	●	Compatible
ALM	Status	Alarm currently being generated can be confirmed.	●	●	●	Compatible
	ALM Log record	Alarms generated in the past can be confirmed.	×	×	●	Compatible
File	Save/Load	Step data and parameters can be saved, forwarded, and deleted.	×	×	●	Compatible
Other	Language	Can be changed to Japanese or English	●	●	●	Compatible

△: Can be set from TB Ver. 2.\*\* (The version information is displayed on the initial screen.)

\*1 Check the catalog and operation manual of each actuator model which is capable of performing pushing operations.

The “Specifications” table for models which are capable of performing pushing operations includes an item for the pushing force.

## Fieldbus Network

# EtherCAT/EtherNet/IP™/PROFINET Direct Input Type Step Motor Controller/JXC□H Series p. 68

**ACT 2** Controller Setting Software  
ACT Controller 2



○ **Two types of operation command**

**Step no. defined operation:** Operate using the preset step data in the controller.  
**Numerical data defined operation:** The actuator operates using values such as position and speed from the PLC.

○ **Numerical monitoring available**

Numerical information, such as the current speed, current position, and alarm codes, can be monitored on the PLC.

○ **Transition wiring of communication cables**

Two communication ports are provided.

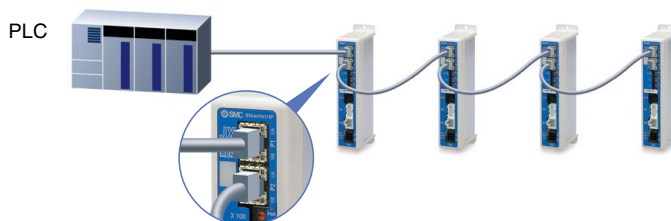

### Application

Communication protocols

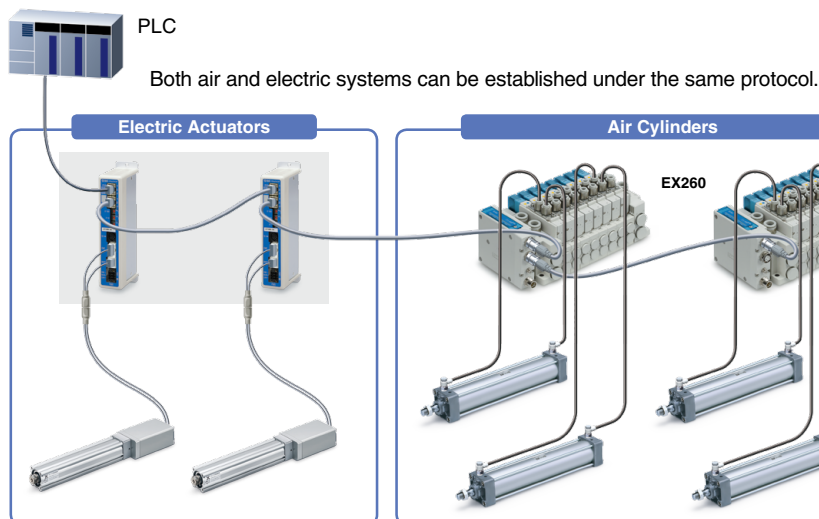

**ACT 2** Controller Setting Software ACT Controller 2 From p. 1

## Easy-to-use setting software ACT Controller 2 (For PC)

**Various functions available in normal mode** (Compared with the existing ACT Controller)

- Parameter and step data setting
- Alarm confirmation
- Waveform monitoring
- The JXC-BC writing tool
- Customizable plug-in functions

\* Customers operating computers with specifications other than Windows 10/64 bit and Windows 11 should use the existing ACT Controller.

**System Construction/General Purpose I/O**

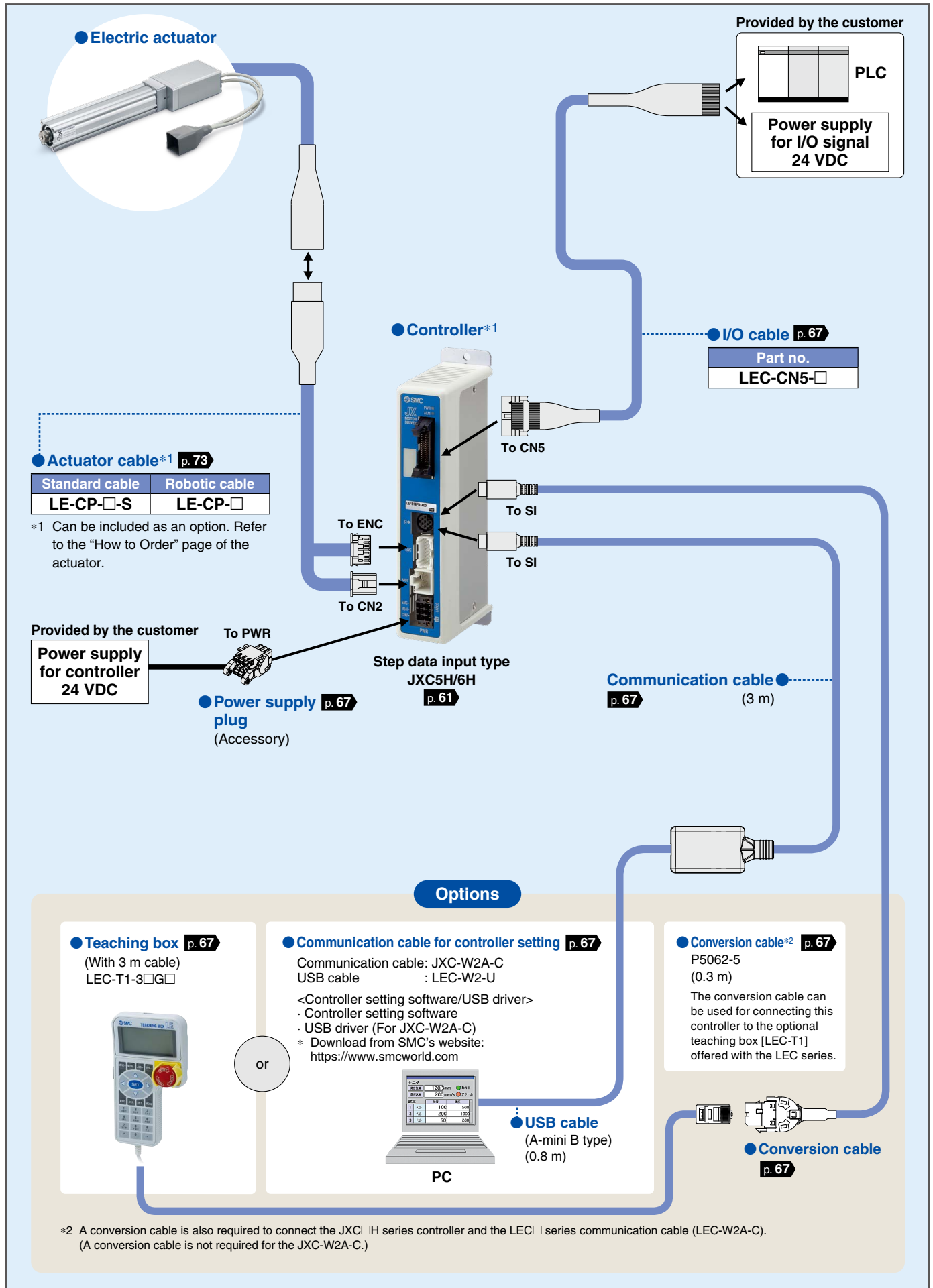

\*2 A conversion cable is also required to connect the JXC□H series controller and the LEC□ series communication cable (LEC-W2A-C). (A conversion cable is not required for the JXC-W2A-C.)

## System Construction/Fieldbus Network (EtherCAT/EtherNet/IP™/PROFINET Direct Input Type)

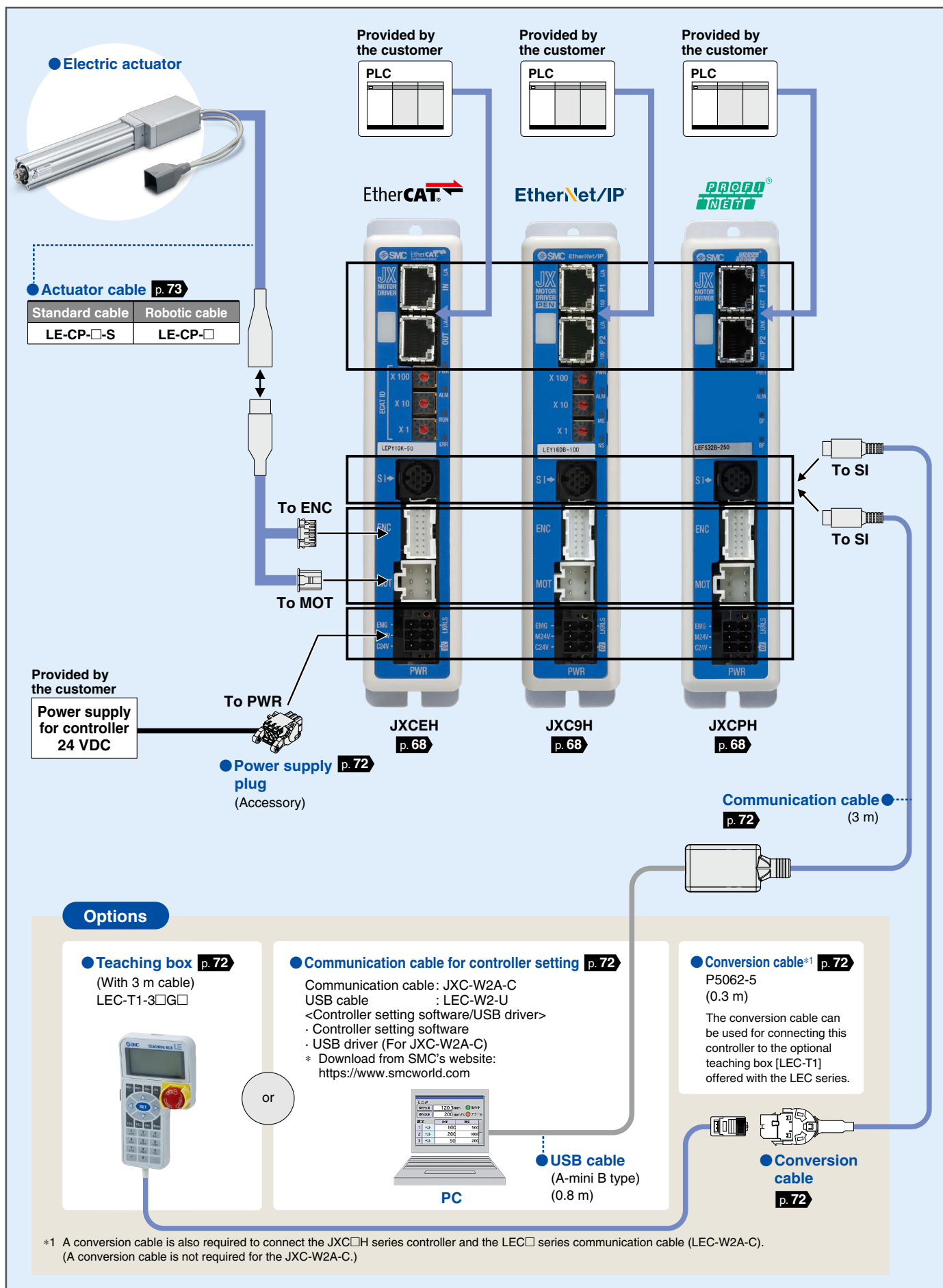





# CONTENTS

## High Performance Slider Type/Ball Screw Drive *LEFS*□*F* Series **p. 10**

Incremental (Step Motor 24 VDC)

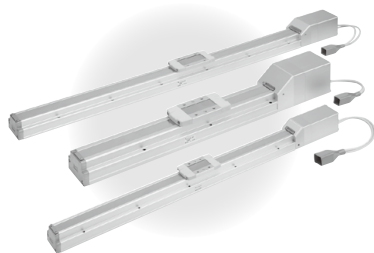

Model Selection .....	p. 11
How to Order .....	p. 19
Specifications .....	p. 21
Dimensions .....	p. 23
Auto Switch Mounting .....	p. 30

## High Performance Rod Type *LEY*□*F* Series **p. 34**

Incremental (Step Motor 24 VDC)

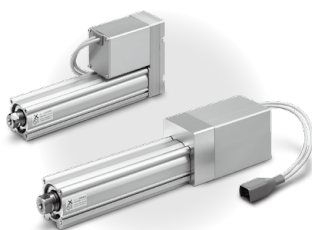

Model Selection .....	p. 35
How to Order .....	p. 43
Specifications .....	p. 45
Dimensions .....	p. 47
Auto Switch Mounting .....	p. 55

## Controllers *JXC*□*H* Series **p. 60**

### High Performance Controller (Step Data Input Type) *JXC5H/6H* Series **Incremental (Step Motor 24 VDC)**



How to Order .....	p. 61
Specifications .....	p. 61
Dimensions .....	p. 63
Options .....	p. 67
Actuator Cable .....	p. 73

### High Performance Step Motor Controller *JXCEH/9H/PH* Series **Incremental (Step Motor 24 VDC)**



How to Order .....	p. 68
Specifications .....	p. 69
Dimensions .....	p. 70
Options .....	p. 72
Actuator Cable .....	p. 73

Precautions Relating to Differences in Controller Versions .....	p. 74
--	-------

<b>CE/UKCA/UL-compliance List</b> .....	p. 75
---	-------

# Electric Actuators

## High Performance Slider Type

Slider Type/Ball Screw Drive *LEFS□F Series*

p. 11

Incremental (Step Motor 24 VDC)

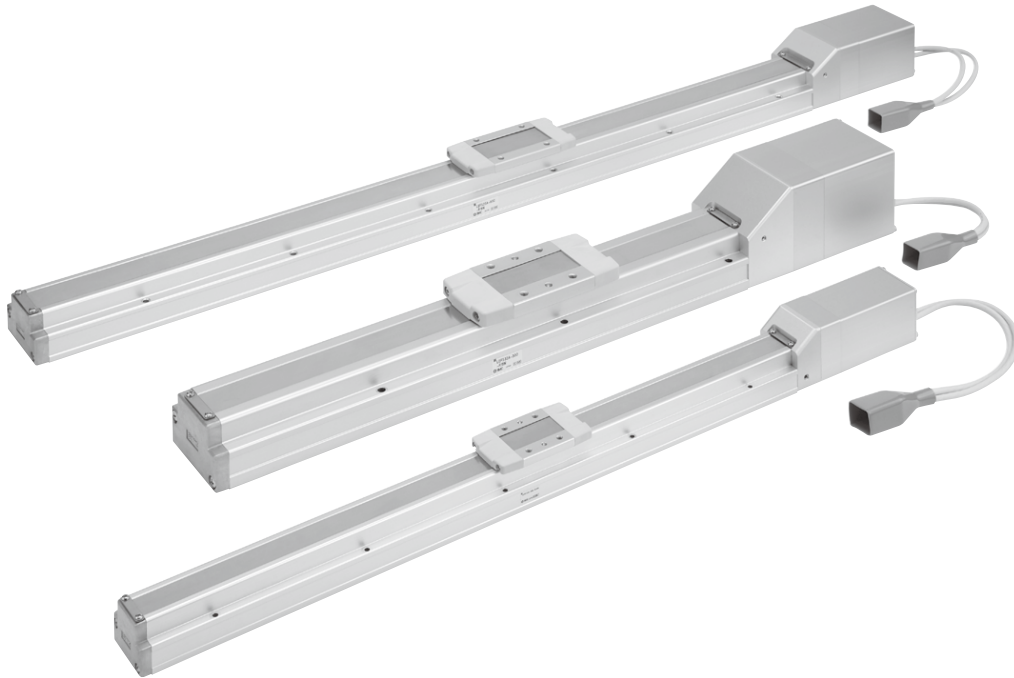

Controllers [p. 60](#)

Model Selection

LEFS□F Series

LEY□F Series

Auto Switch

JXC5H/6H Series

JXCEH/9H/PH Series

# Model Selection

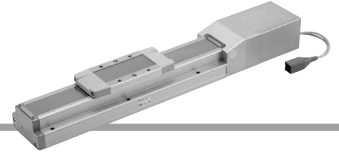

## Selection Procedure



## Selection Example

### Operating conditions

- Workpiece mass: 10 [kg]
- Speed: 300 [mm/s]
- Acceleration/Deceleration: 10000 [mm/s<sup>2</sup>]
- Stroke: 200 [mm]
- Mounting orientation: Horizontal upward
- Workpiece mounting condition:

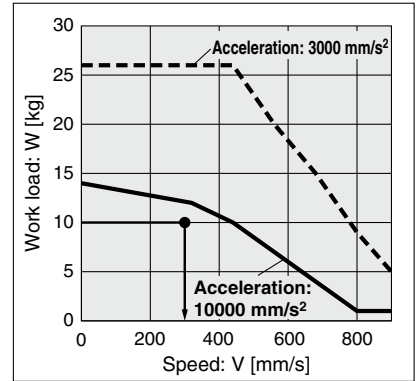
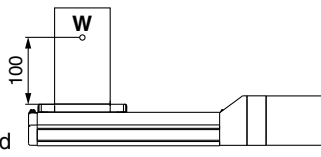

<Speed-Work load graph>  
(LEFS25FA/Step motor)

**Step 1 Check the work load-speed.** <Speed-Work load graph> (pages 12 to 15)  
Select a model based on the workpiece mass and speed while referencing the speed-work load graph.

Selection example) The **LEFS25FA-200** can be temporarily selected as a possible candidate based on the graph shown on the right side.

### Step 2 Check the cycle time.

Calculate the **cycle time** using the following calculation method.

#### Cycle time:

T can be found from the following equation.

$$T = T1 + T2 + T3 + T4 \text{ [s]}$$

- T1: Acceleration time and T3: Deceleration time can be found by the following equation.

$$T1 = V/a1 \text{ [s]} \quad T3 = V/a2 \text{ [s]}$$

- T2: Constant speed time can be found from the following equation.

$$T2 = \frac{L - 0.5 \cdot V \cdot (T1 + T3)}{V} \text{ [s]}$$

- T4: Settling time varies depending on the conditions such as actuator types, load, and in position of the step data. Reference value for settling time: 0.15 s or less. The following value is used for this calculation.

$$T4 = 0.15 \text{ [s]}$$

Calculation example)

T1 to T4 can be calculated as follows.

$$T1 = V/a1 = 300/10000 = 0.03 \text{ [s]}$$

$$T3 = V/a2 = 300/10000 = 0.03 \text{ [s]}$$

$$T2 = \frac{L - 0.5 \cdot V \cdot (T1 + T3)}{V} = \frac{200 - 0.5 \cdot 300 \cdot (0.03 + 0.03)}{300} = 0.64 \text{ [s]}$$

$$T4 = 0.15 \text{ [s]}$$

The **cycle time** can be found as follows.

$$T = T1 + T2 + T3 + T4 = 0.03 + 0.64 + 0.03 + 0.15 = 0.85 \text{ [s]}$$

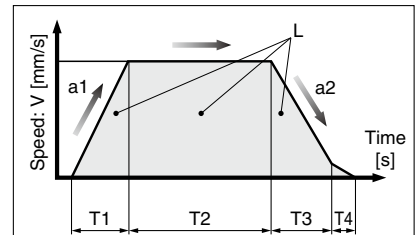

- L : Stroke [mm] ... (Operating condition)
- V : Speed [mm/s] ... (Operating condition)
- a1: Acceleration [mm/s<sup>2</sup>] ... (Operating condition)
- a2: Deceleration [mm/s<sup>2</sup>] ... (Operating condition)

- T1: Acceleration time [s]  
Time until reaching the set speed
- T2: Constant speed time [s]  
Time while the actuator is operating at a constant speed
- T3: Deceleration time [s]  
Time from the beginning of the constant speed operation to stop
- T4: Settling time [s]  
Time until positioning is completed

### Step 3 Check the allowable moment.

<Static allowable moment> (page 15)  
<Dynamic allowable moment> (page 16)

Confirm the moment that applies to the actuator is within the allowable range for both static and dynamic conditions.

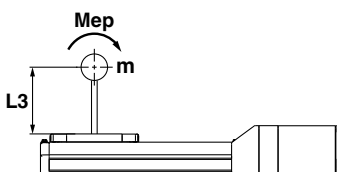

Based on the above calculation result, the **LEFS25FA-200** should be selected.

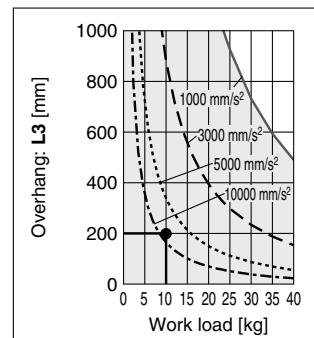

### Speed-Work Load Graph (Guide)

\* The following graphs show the values when the moving force is 100%.

#### LEFS16FA/Ball Screw Drive

##### Horizontal/Lead 10

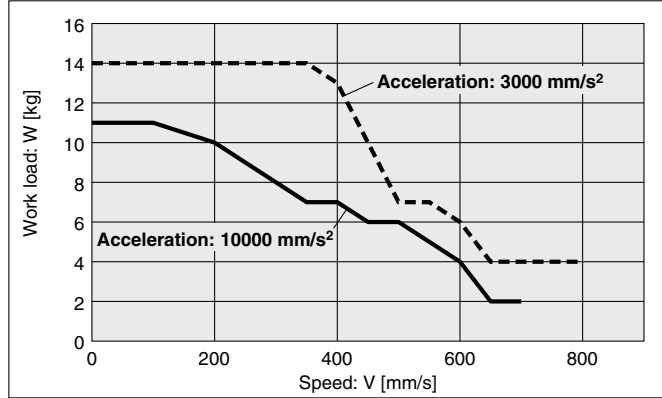

##### Vertical/Lead 10

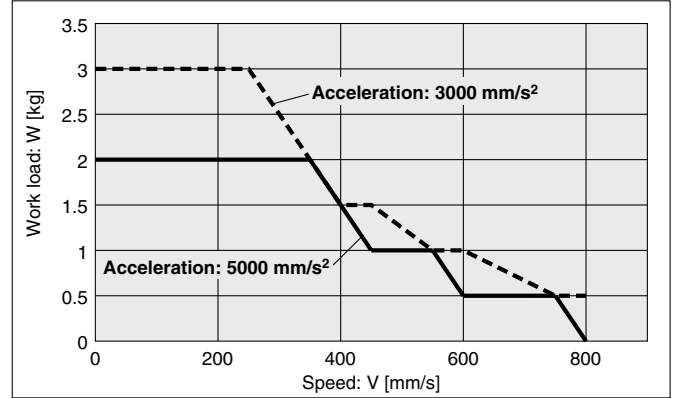

#### LEFS16FB/Ball Screw Drive

##### Horizontal/Lead 5

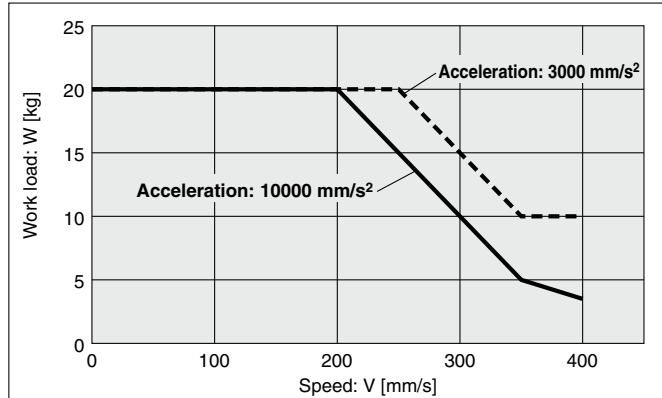

##### Vertical/Lead 5

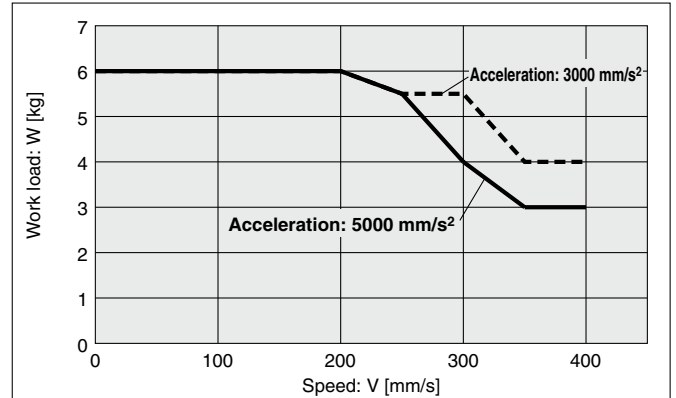

Model Selection

LEFS□F Series

LEY□F Series

Auto Switch

JXC5H/6H Series

JXCEH/9H/PH Series

## Speed-Work Load Graph (Guide)

\* The following graphs show the values when the moving force is 100%.

### LEFS25FH/Ball Screw Drive

#### Horizontal/Lead 20

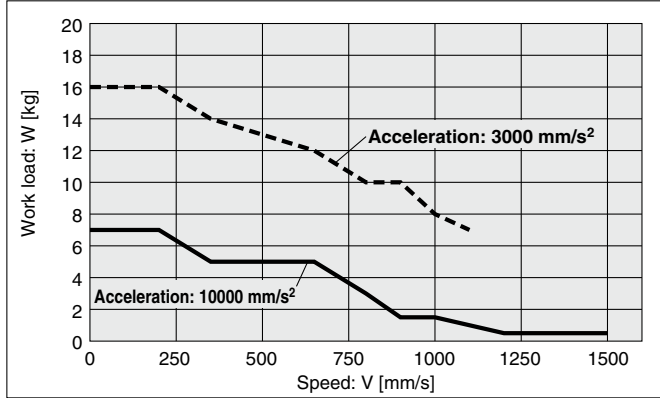

#### Vertical/Lead 20

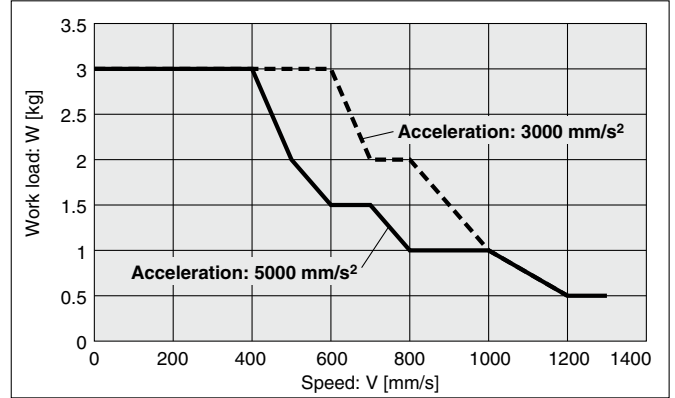

### LEFS25FA/Ball Screw Drive

#### Horizontal/Lead 12

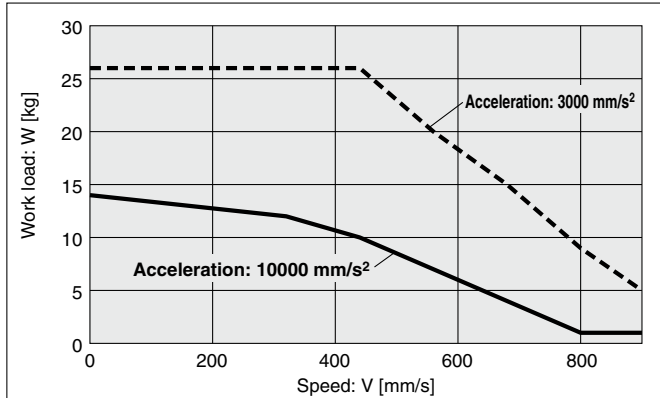

#### Vertical/Lead 12

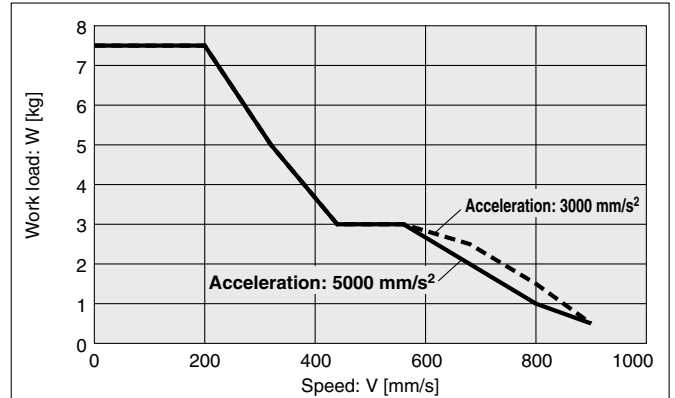

### LEFS25FB/Ball Screw Drive

#### Horizontal/Lead 6

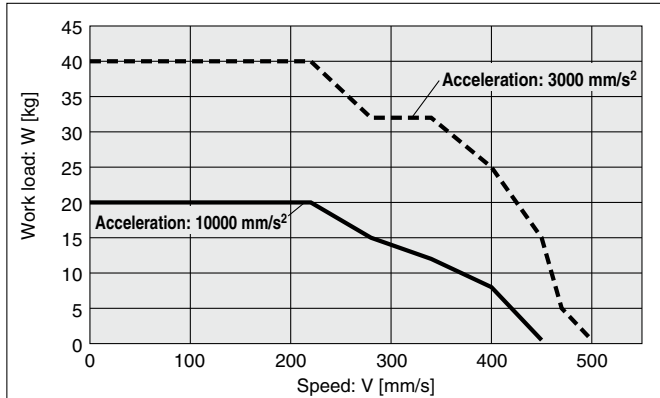

#### Vertical/Lead 6

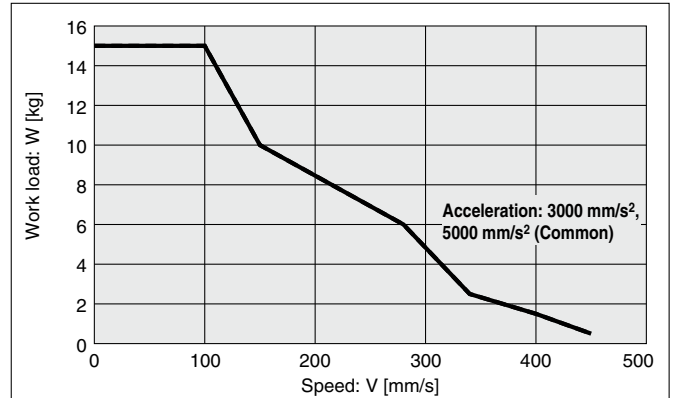

**Speed-Work Load Graph (Guide)**

\* The following graphs show the values when the moving force is 100%.

**LEFS32FH/Ball Screw Drive**

**Horizontal/Lead 24**

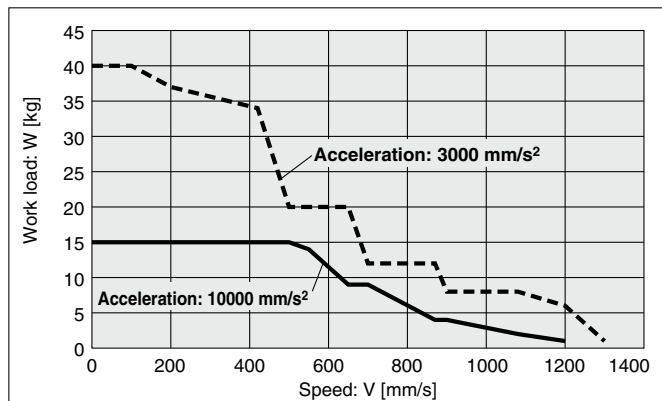

**Vertical/Lead 24**

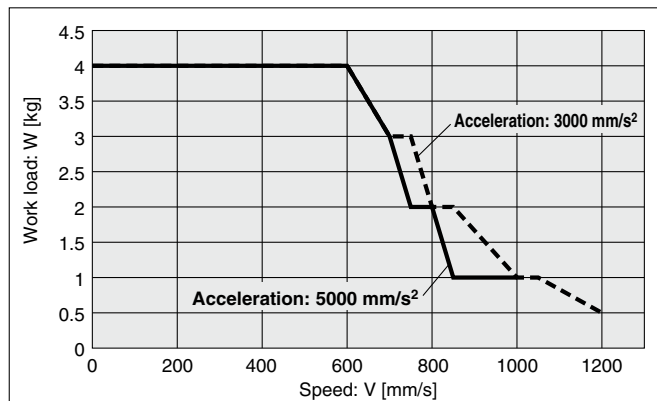

**LEFS32FA/Ball Screw Drive**

**Horizontal/Lead 16**

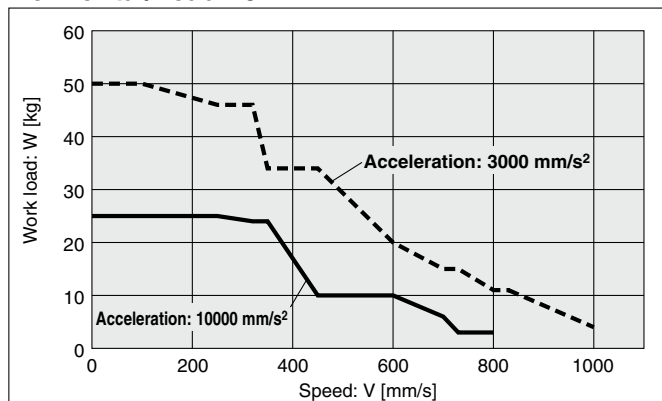

**Vertical/Lead 16**

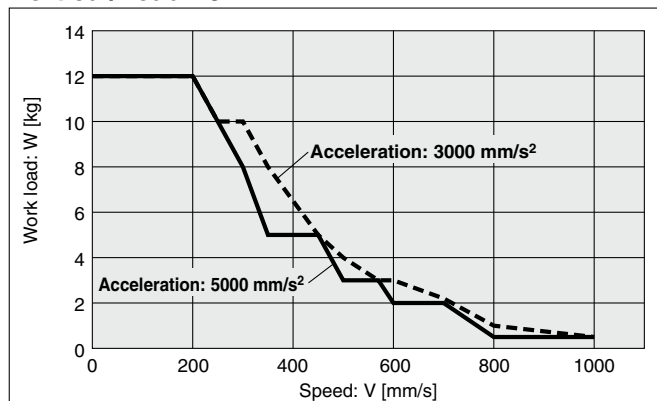

**LEFS32FB/Ball Screw Drive**

**Horizontal/Lead 8**

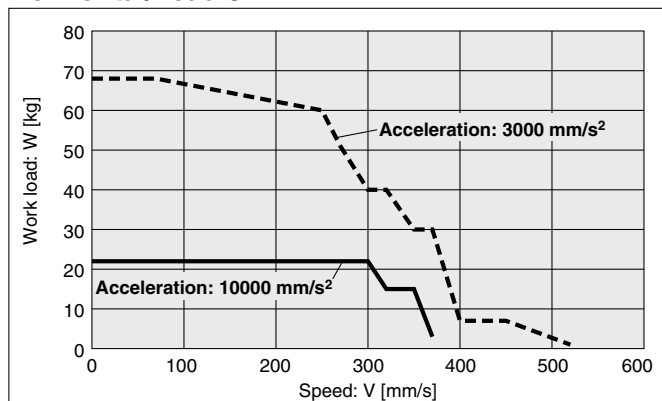

**Vertical/Lead 8**

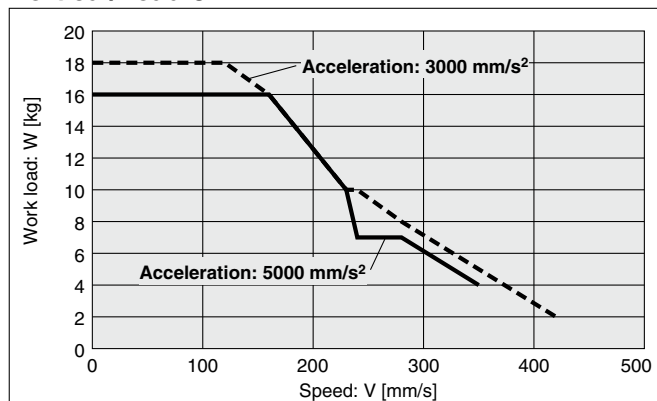

Model Selection  
**LEFS□F Series**  
 LEY□F Series  
 Auto Switch  
 JXC5H/6H Series  
 JXCEH/9H/PH Series

## Speed-Work Load Graph (Guide)

\* The following graphs show the values when the moving force is 100%.

### LEFS40FH/Ball Screw Drive

#### Horizontal/Lead 30

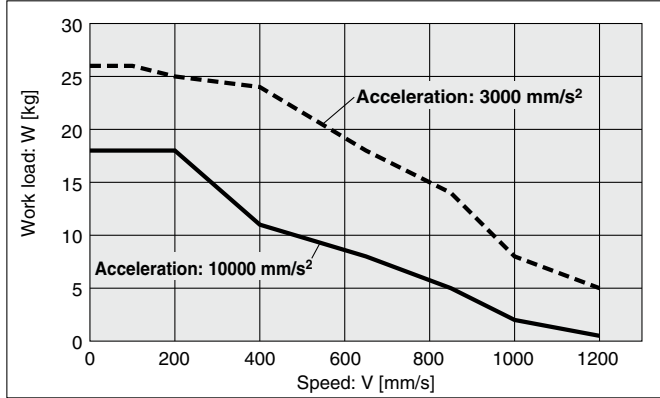

#### Vertical/Lead 30

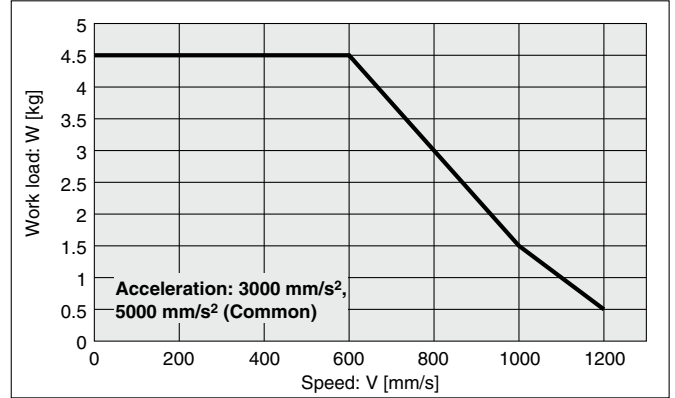

### LEFS40FA/Ball Screw Drive

#### Horizontal/Lead 20

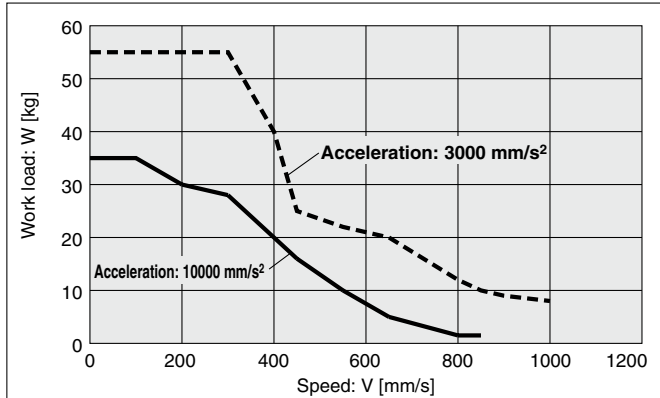

#### Vertical/Lead 20

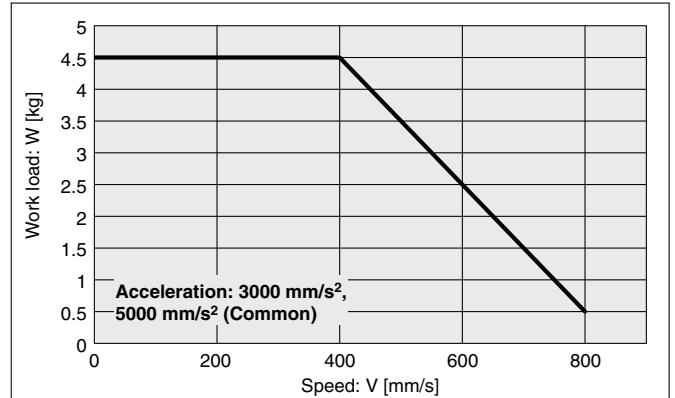

### LEFS40FB/Ball Screw Drive

#### Horizontal/Lead 10

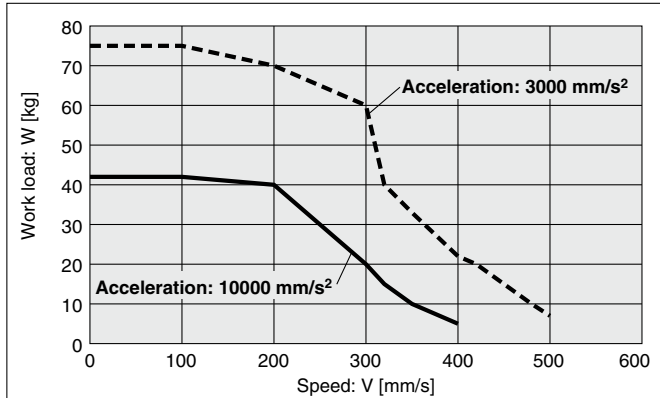

#### Vertical/Lead 10

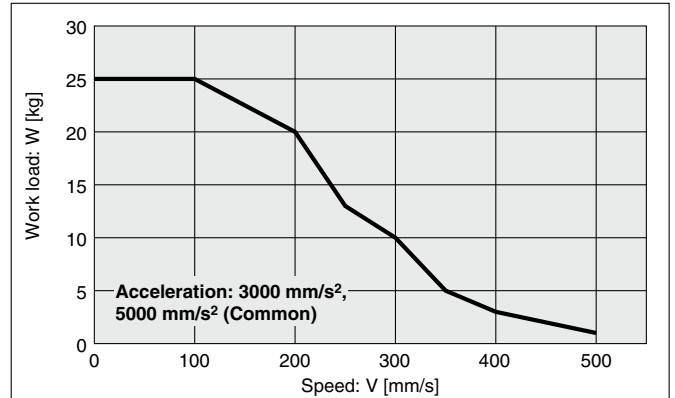

## Static Allowable Moment\*1

		[N·m]		
Model	Size	Pitching	Yawing	Rolling
LEFS□	16	10.0	10.0	20.0
	25	27.0	27.0	52.0
	32	46.0	46.0	101.0
	40	110.0	110.0	207.0

\*1 The static allowable moment is the amount of static moment which can be applied to the actuator when it is stopped.  
If the product is exposed to impact or repeated load, be sure to take adequate safety measures when using the product.



**Dynamic Allowable Moment**

\* These graphs show the amount of allowable overhang (guide unit) when the center of gravity of the workpiece overhangs in one direction.

Acceleration ——— 1000 mm/s<sup>2</sup>    - - - 3000 mm/s<sup>2</sup>    ······ 5000 mm/s<sup>2</sup>    - - - - 10000 mm/s<sup>2</sup>

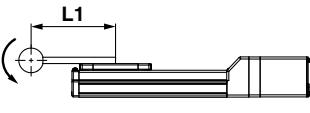
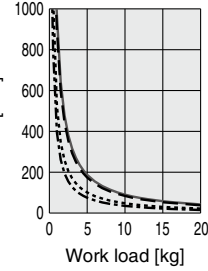
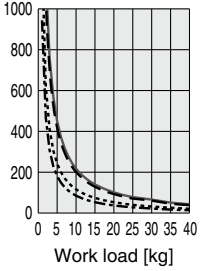
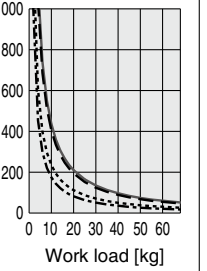
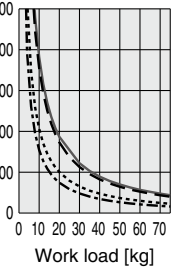
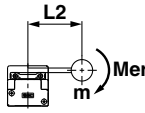
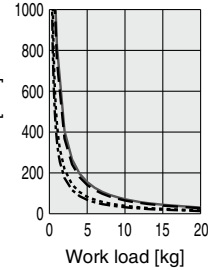
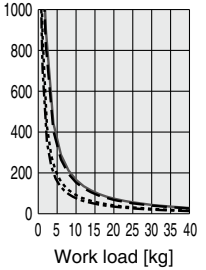
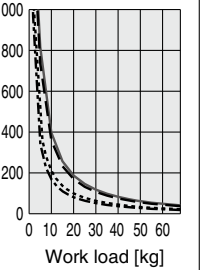
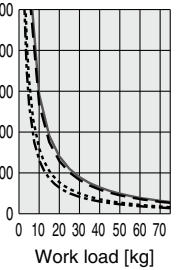
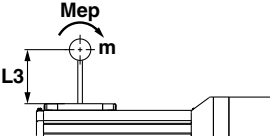
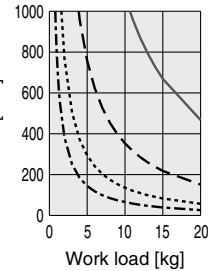
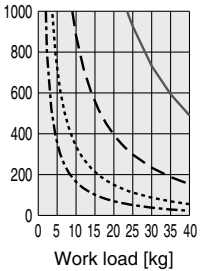
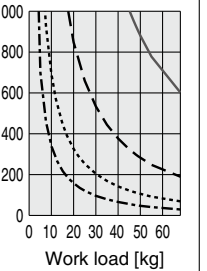
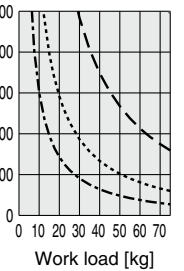
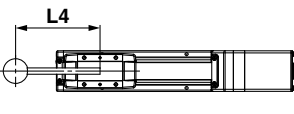
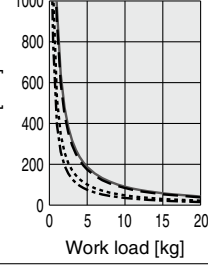
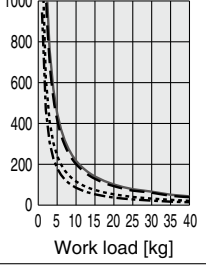
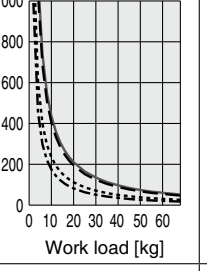
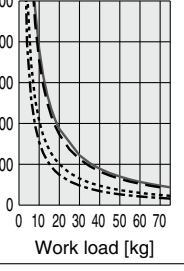
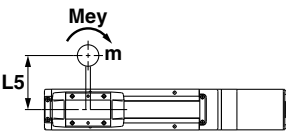
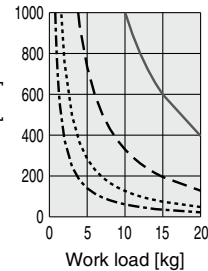
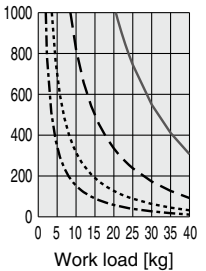
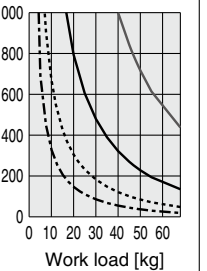
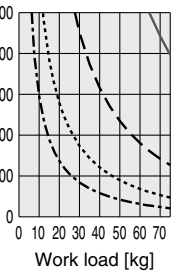
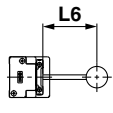
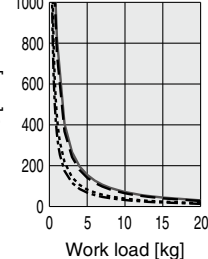
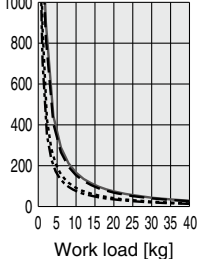
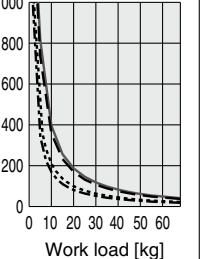
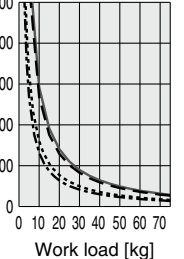
Orientation	Load overhanging direction m : Work load [kg] Me: Allowable moment [N·m] L : Overhang to the work load center of gravity [mm]	Model			
		LEFS16F	LEFS25F	LEFS32F	LEFS40F
Horizontal/Bottom	 X L1 [mm]				
	 Y L2 [mm]				
	 Z L3 [mm]				
Wall	 X L4 [mm]				
	 Y L5 [mm]				
	 Z L6 [mm]				

Model Selection  
LEFS□F Series  
LEY□F Series  
Auto Switch  
JXC5H/6H Series  
JXCEH/9H/PH Series

## Dynamic Allowable Moment

\* These graphs show the amount of allowable overhang (guide unit) when the center of gravity of the workpiece overhangs in one direction.

Acceleration ——— 1000 mm/s<sup>2</sup>    - - - 3000 mm/s<sup>2</sup>    ······ 5000 mm/s<sup>2</sup>

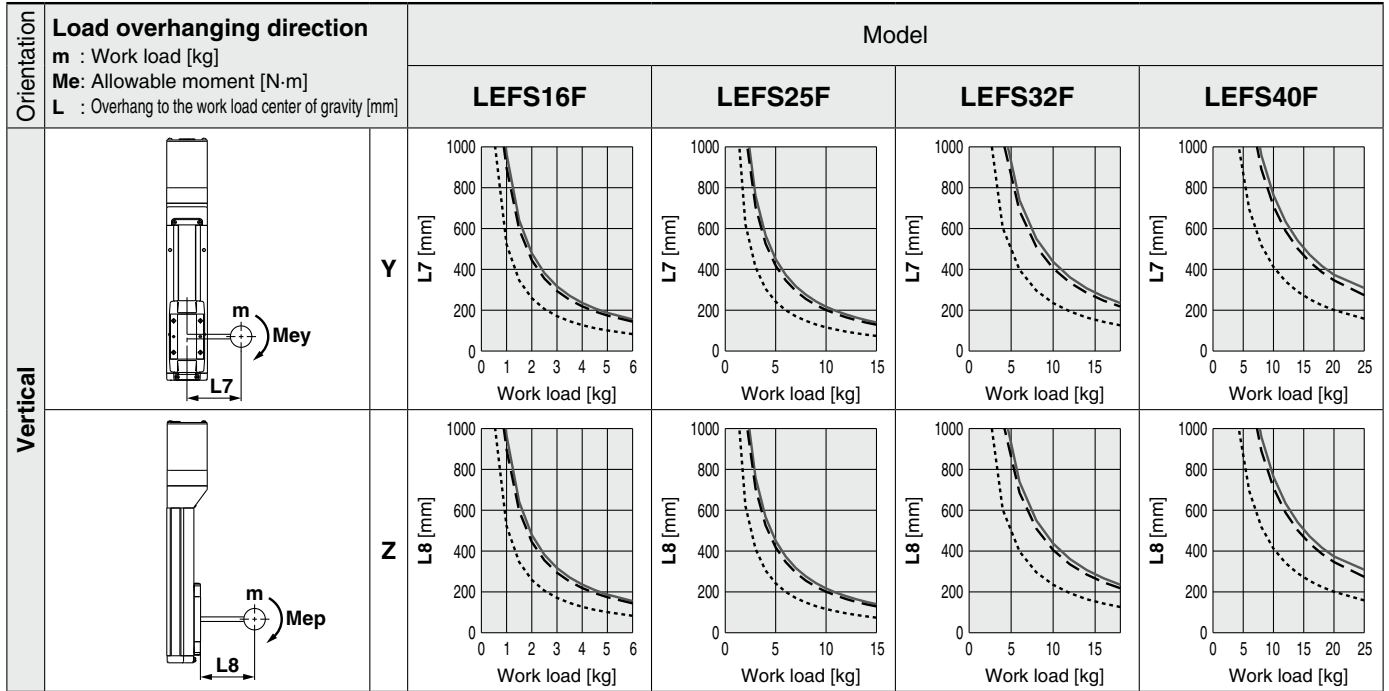

## Calculation of Guide Load Factor

1. Decide operating conditions.

Model: LEFS□F

Size: 25/32/40

Mounting orientation: Horizontal/Bottom/Wall/Vertical

Acceleration [mm/s<sup>2</sup>]: a

Work load [kg]: m

Work load center position [mm]: Xc/Yc/Zc

2. Select the target graph while referencing the model, size, and mounting orientation.

3. Based on the acceleration and work load, find the overhang [mm]: Lx/Ly/Lz from the graph.

4. Calculate the load factor for each direction.

$$\alpha_x = X_c/L_x, \alpha_y = Y_c/L_y, \alpha_z = Z_c/L_z$$

5. Confirm the total of  $\alpha_x$ ,  $\alpha_y$ , and  $\alpha_z$  is 1 or less.

$$\alpha_x + \alpha_y + \alpha_z \leq 1$$

When 1 is exceeded, please consider a reduction of acceleration and work load, or a change of the work load center position and series.

### Mounting orientation

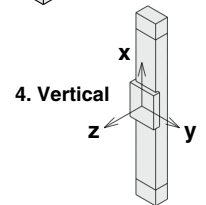
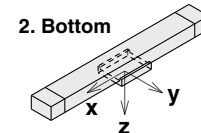
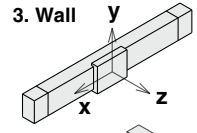
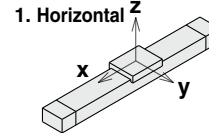

### Example

1. Operating conditions

Model: LEFS40F

Size: 40

Mounting orientation: Horizontal

Acceleration [mm/s<sup>2</sup>]: 3000

Work load [kg]: 20

Work load center position [mm]: Xc = 0, Yc = 50, Zc = 200

2. Select the graphs for horizontal of the LEFS40F on page 16.

3. Lx = 350 mm, Ly = 250 mm, Lz = 1000 mm

4. The load factor for each direction can be found as follows.

$$\alpha_x = 0/350 = 0$$

$$\alpha_y = 50/250 = 0.2$$

$$\alpha_z = 200/1000 = 0.2$$

5.  $\alpha_x + \alpha_y + \alpha_z = 0.4 \leq 1$

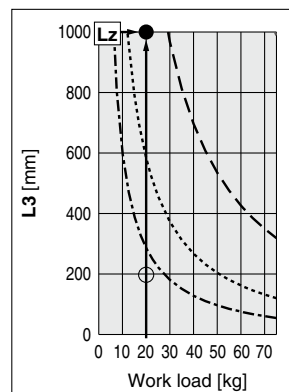
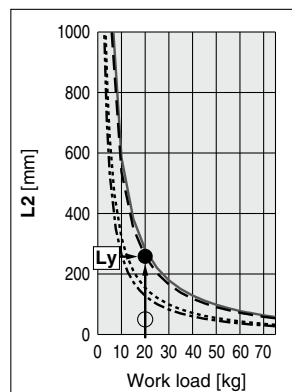
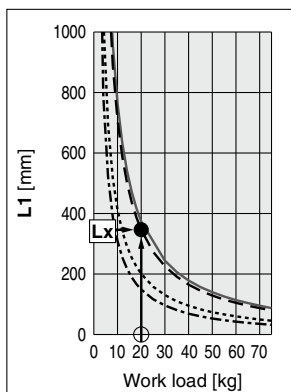

**Table Accuracy (Reference Value)**

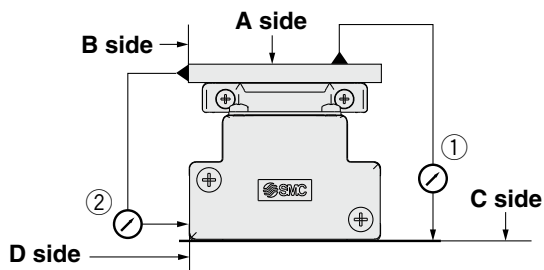

Model	Traveling parallelism [mm] (Every 300 mm)	
	① C side traveling parallelism to A side	② D side traveling parallelism to B side
LEFS16F	0.05	0.03
LEFS25F	0.05	0.03
LEFS32F	0.05	0.03
LEFS40F	0.05	0.03

\* Traveling parallelism does not include the mounting surface accuracy. (Excludes when the stroke exceeds 2000 mm)

**Table Displacement (Reference Value)**

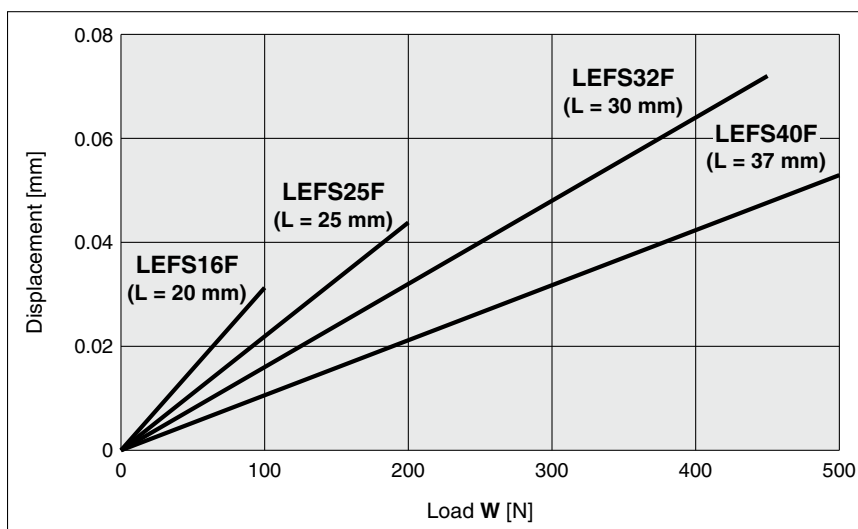
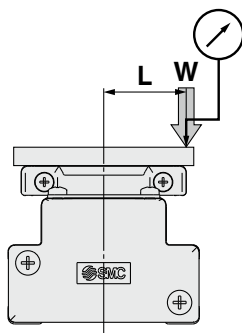

\* This displacement is measured when a 15 mm aluminum plate is mounted and fixed on the table.  
 \* Check the clearance and play of the guide separately.

**Overhang Displacement Due to Table Clearance (Initial Reference Value)**

**Basic type**

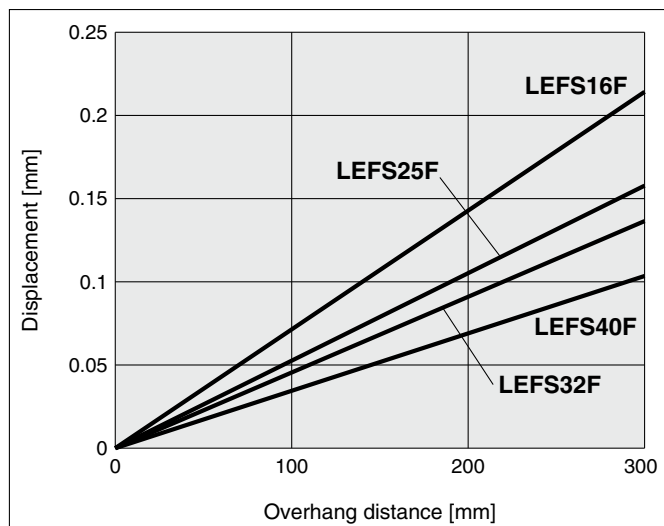

**High-precision type**

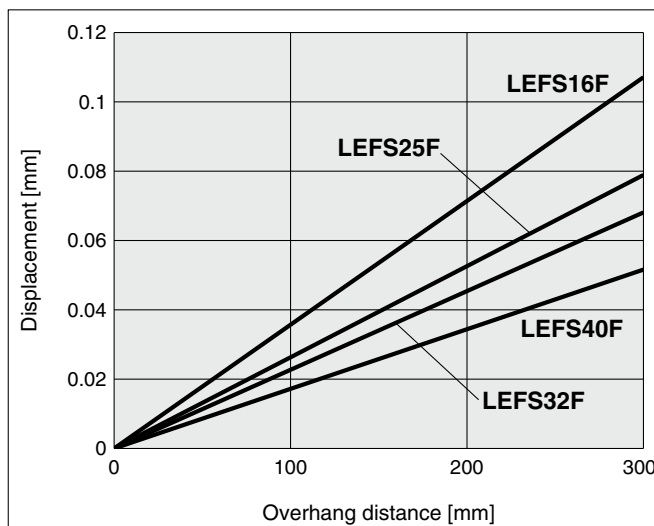

Model Selection  
 LEFS□F Series  
 LEY□F Series  
 Auto Switch  
 JXC5H/6H Series  
 JXCEH/9H/PH Series

Incremental (Step Motor 24 VDC)

# High Performance Slider Type Ball Screw Drive

## LEFS□F Series LEFS16, 25, 32, 40



For details, refer to page 75.



### How to Order

LEFS **H** **25** **F** **B** - **200** **C** **N** **K** - **S1** **C5H73**

①
②
③
④
⑤
⑥
⑦
⑧
⑨
⑩
⑪
⑫

For details on controllers, refer to page 20.

#### ① Accuracy

Nil	Basic type
H	High-precision type

#### ② Size

16
25
32
40

#### ④ Motor type

Symbol	Type	Applicable size				Compatible controllers
		LEFS16	LEFS25	LEFS32	LEFS40	
F	High performance (Step motor 24 VDC)	●	●	●	●	JXC5H JXC6H JXCEH JXC9H JXCPH

#### ③ Motor mounting position

Nil	In-line
-----	---------

#### ⑤ Lead [mm]

Symbol	LEFS16	LEFS25	LEFS32	LEFS40
H	—	20	24	30
A	10	12	16	20
B	5	6	8	10

#### ⑥ Stroke\*1 [mm]

Stroke	Note	
	Size	Applicable stroke
50 to 500	16	50, 100, 150, 200, 250, 300, 350, 400, 450, 500
50 to 800	25	50, 100, 150, 200, 250, 300, 350, 400, 450, 500, 550, 600, 650, 700, 750, 800
50 to 1000	32	50, 100, 150, 200, 250, 300, 350, 400, 450, 500, 550, 600, 650, 700, 750, 800, 850, 900, 950, 1000
150 to 1200	40	150, 200, 250, 300, 350, 400, 450, 500, 550, 600, 650, 700, 750, 800, 850, 900, 950, 1000, 1100, 1200

#### ⑦ Motor option

Nil	Without option
B	With lock

#### ⑧ Auto switch compatibility\*2 \*3 \*4 \*5

Nil	None
C	With (Includes 1 mounting bracket)

#### ⑨ Grease application (Seal band part)

Nil	With
N	Without (Roller specification)

#### ⑩ Positioning pin hole

Nil	Housing B bottom*6	
K	Body bottom 2 locations	

#### ⑪ Actuator cable type/length\*8

Standard cable [m]		Robotic cable [m]			
Nil	None	R1	1.5	RA	10*7
S1	1.5	R3	3	RB	15*7
S3	3	R5	5	RC	20*7
S5	5	R8	8*7		

For auto switches, refer to pages 30 to 33.

**12 Controller**

Nil	Without controller
C□H□□	With controller



**Interface (Communication protocol/Input/Output)**

<b>5</b>	Parallel I/O (NPN)
<b>6</b>	Parallel I/O (PNP)
<b>E</b>	EtherCAT
<b>9</b>	EtherNet/IP™
<b>P</b>	PROFINET

**Mounting**

<b>7</b>	Screw mounting
<b>8</b> *9	DIN rail

**Number of axes/Special specification**

<b>H</b>	1 axis/High performance type
----------	------------------------------

**Communication plug connector, I/O cable\*10**

Symbol	Type	Applicable interface
Nil	Without accessory	—
<b>1</b>	I/O cable (1.5 m)	Parallel input (NPN) Parallel input (PNP)
<b>3</b>	I/O cable (3 m)	
<b>5</b>	I/O cable (5 m)	

- \*1 Please contact SMC for non-standard strokes as they are produced as special orders.
- \*2 Excluding the LEFS16
- \*3 If 2 or more are required, please order them separately. (Part no.: LEF-D-2-1 For details, refer to the **Web Catalog**.)
- \*4 The auto switches must be ordered separately. (For details, refer to the **Web Catalog**.)
- \*5 When "Nil" is selected, the product will not come with a built-in magnet for an auto switch, and so a mounting bracket cannot be secured. Be sure to select an appropriate model initially as the product cannot be changed to have auto switch compatibility after purchase.

- \*6 For details on the mounting method, refer to the **Web Catalog**.
- \*7 Produced upon receipt of order (Robotic cable only)
- \*8 The standard cable should only be used on fixed parts. For use on moving parts, select the robotic cable.
- \*9 The DIN rail is not included. It must be ordered separately.
- \*10 Select "Nil" for anything other than parallel input. Select "Nil," "1," "3," or "5" for parallel input.

**⚠ Caution**

**[CE/UKCA-compliant products]**

EMC compliance was tested by combining the electric actuator LEF series and the controller JXC series.

The EMC depends on the configuration of the customer's control panel and the relationship with other electrical equipment and wiring. Therefore, compliance with the EMC directive cannot be certified for SMC components incorporated into the customer's equipment under actual operating conditions. As a result, it is necessary for the customer to verify compliance with the EMC directive for the machinery and equipment as a whole.

**■ Trademark**

EtherNet/IP® is a registered trademark of ODVA, Inc.  
 EtherCAT® is registered trademark and patented technology, licensed by Beckhoff Automation GmbH, Germany.

**The actuator and controller are sold as a package.**

Confirm that the combination of the controller and actuator is correct.

**<Check the following before use.>**

- \*1 Check the actuator label for the model number. This number should match that of the controller.



\*1

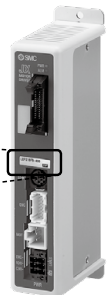

\* Refer to the Operation Manual for using the products.  
 Please download it via our website: <https://www.smcworld.com>

**Compatible Controllers**

Type	Step data input type	EtherCAT direct input type	EtherNet/IP™ direct input type	PROFINET direct input type
<b>Series</b>	<b>JXC5H JXC6H</b>	<b>JXCEH</b>	<b>JXC9H</b>	<b>JXCPH</b>
<b>Features</b>	Parallel I/O	EtherCAT direct input	EtherNet/IP™ direct input	PROFINET direct input
<b>Compatible motor</b>	Step motor 24 VDC	Step motor (Servo/24 VDC)		
<b>Max. number of step data</b>	64 points	64 points		
<b>Power supply voltage</b>	24 VDC	24 VDC		
<b>Reference page</b>	61	68		

## Specifications

Model		LEFS16F			LEFS25F			LEFS32F			LEFS40F				
Actuator specifications	Stroke [mm]* <sup>1</sup>	50 to 500			50 to 800			50 to 1000			150 to 1200				
	Work load [kg]* <sup>2</sup>	Horizontal			14	20	16	28*	40	40	50	68	26	60*	75
		Vertical			3	6	3	7.5	15	4	12	18	4.5	4.5	25
	Speed [mm/s]	Stroke range	Up to 400	10 to 800	5 to 400	20 to 1500	12 to 900	6 to 500	24 to 1300	16 to 1000	8 to 520	30 to 1200	20 to 1000	10 to 500	
			401 to 500	10 to 700	5 to 360	20 to 1100	12 to 750	6 to 400	24 to 1300	16 to 950	8 to 520	30 to 1200	20 to 1000	10 to 500	
			501 to 600	—	—	20 to 900	12 to 540	6 to 270	24 to 1200	16 to 800	8 to 400	30 to 1200	20 to 1000	10 to 500	
			601 to 700	—	—	20 to 630	12 to 420	6 to 230	24 to 930	16 to 620	8 to 310	30 to 1200	20 to 900	10 to 440	
			701 to 800	—	—	20 to 550	12 to 330	6 to 180	24 to 750	16 to 500	8 to 250	30 to 1140	20 to 760	10 to 350	
			801 to 900	—	—	—	—	—	24 to 610	16 to 410	8 to 200	30 to 930	20 to 620	10 to 280	
			901 to 1000	—	—	—	—	—	24 to 500	16 to 340	8 to 170	30 to 780	20 to 520	10 to 250	
			1001 to 1100	—	—	—	—	—	—	—	—	30 to 660	20 to 440	10 to 220	
	1101 to 1200	—	—	—	—	—	—	—	—	30 to 570	20 to 380	10 to 190			
	Max. acceleration/deceleration [mm/s <sup>2</sup> ]	Horizontal		10000											
		Vertical		5000											
	Positioning repeatability [mm]	Basic type		±0.02											
		High-precision type		±0.015 (Lead H: ±0.02)											
	Lost motion [mm]* <sup>3</sup>	Basic type		0.1 or less											
		High-precision type		0.05 or less											
	Lead [mm]		10	5	20	12	6	24	16	8	30	20	10		
	Impact/Vibration resistance [m/s <sup>2</sup> ]* <sup>4</sup>		50/20												
Actuation type		Ball screw													
Guide type		Linear guide													
Static allowable moment* <sup>5</sup>	Mep (Pitching)		10			27			46			110			
	Mey (Yawing)		10			27			46			110			
	Mer (Rolling)		20			52			101			207			
Operating temperature range [°C]		5 to 40													
Operating humidity range [%RH]		90 or less (No condensation)													
Enclosure		IP30													
Electric specifications	Motor size		□28			□42			□56.4			□56.4			
	Motor type		Step motor (Servo/24 VDC)												
	Encoder		Incremental												
	Power supply voltage [V]		24 VDC ±10%												
	Power [W]* <sup>6</sup> * <sup>8</sup>		Max. power 102			Max. power 132			Max. power 158			Max. power 202			
Lock unit specifications	Type* <sup>7</sup>		Non-magnetizing lock												
	Holding force [N]		29	59	47	78	157	72	108	216	75	113	245		
	Power [W]* <sup>8</sup>		2.9			5			5			5			
	Rated voltage [V]		24 VDC ±10%												

\*1 Please contact SMC for non-standard strokes as they are produced as special orders.

\*2 The max. work load at 3000 mm/s<sup>2</sup> acceleration and deceleration speed. (Values with \* show the max. work load at 1000 mm/s<sup>2</sup> acceleration and deceleration speed.) Work load varies depending on the speed and acceleration. Check the "Speed-Work Load Graph" on pages 12 to 15. Furthermore, if the cable length exceeds 5 m, the speed and work load specified in the "Speed-Work Load Graph" may decrease by up to 10% for each 5 m increase.

\*3 A reference value for correcting errors in reciprocal operation

\*4 Impact resistance: No malfunction occurred when the actuator was tested with a drop tester in both an axial direction and a perpendicular direction to the lead screw. (The test was performed with the actuator in the initial state.)

Vibration resistance: No malfunction occurred in a test ranging between 45 to 2000 Hz. The test was performed in both an axial direction and a perpendicular direction to the lead screw. (The test was performed with the actuator in the initial state.)

\*5 The static allowable moment is the amount of static moment which can be applied to the actuator when it is stopped.

If the product is exposed to impact or repeated load, be sure to take adequate safety measures when using the product.

\*6 Indicates the max. power during operation (including the controller)

This value can be used for the selection of the power supply.

\*7 With lock only

\*8 For an actuator with lock, add the power for the lock.

## Weight

Series	LEFS16F									
Stroke [mm]	50	100	150	200	250	300	350	400	450	500
Product weight [kg]	0.85	0.92	1.00	1.07	1.15	1.22	1.30	1.37	1.45	1.52
Additional weight with lock [kg]	0.12									

Series	LEFS25F															
Stroke [mm]	50	100	150	200	250	300	350	400	450	500	550	600	650	700	750	800
Product weight [kg]	1.70	1.84	1.98	2.12	2.26	2.40	2.54	2.68	2.82	2.96	3.10	3.24	3.38	3.52	3.66	3.80
Additional weight with lock [kg]	0.26															

Series	LEFS32F																			
Stroke [mm]	50	100	150	200	250	300	350	400	450	500	550	600	650	700	750	800	850	900	950	1000
Product weight [kg]	3.15	3.35	3.55	3.75	3.95	4.15	4.35	4.55	4.75	4.95	5.15	5.35	5.55	5.75	5.95	6.15	6.35	6.55	6.75	6.95
Additional weight with lock [kg]	0.53																			

Series	LEFS40F																			
Stroke [mm]	150	200	250	300	350	400	450	500	550	600	650	700	750	800	850	900	950	1000	1100	1200
Product weight [kg]	5.37	5.65	5.93	6.21	6.49	6.77	7.15	7.33	7.61	7.89	8.17	8.45	8.73	9.01	9.29	9.57	9.85	10.13	10.69	11.25
Additional weight with lock [kg]	0.53																			

Model Selection

LEFS□F Series

LEY□F Series

Auto Switch

JXC5H/6H Series

JXCEH/9H/PH Series

## Dimensions: In-line Motor

### LEFS16F

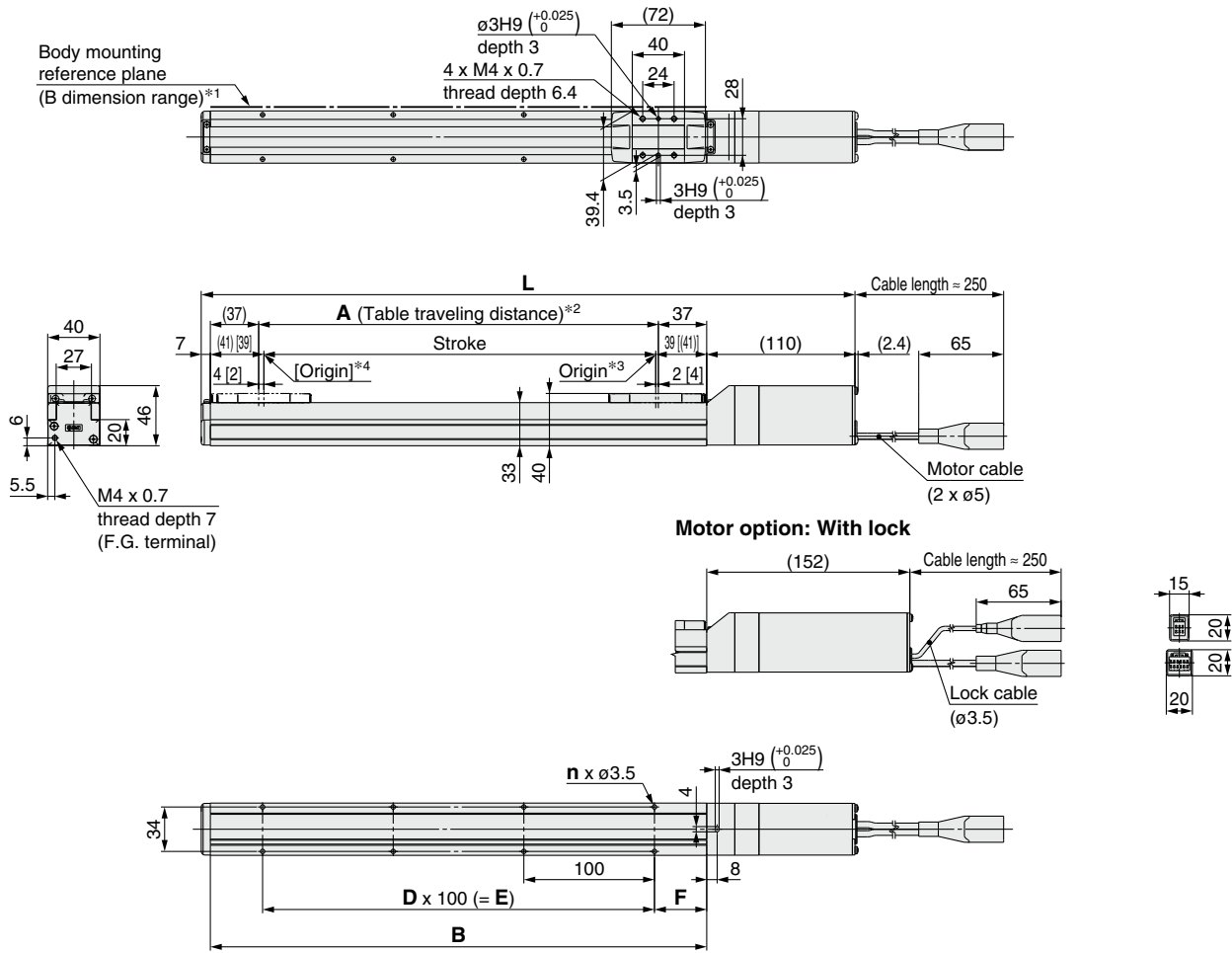

### Positioning pin hole\*5 (Option): Body bottom

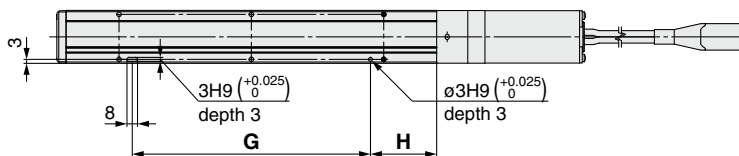

- \*1 When mounting the actuator using the body mounting reference plane, set the height of the opposite surface or pin to be 2 mm or more because of round chamfering. (Recommended height: 5 mm)  
In addition, be aware that surfaces other than the body mounting reference plane (B dimension range) may slightly protrude from the body mounting reference plane. Be sure to provide a clearance of 1 mm or more to avoid interference with workpieces, facilities, etc.
- \*2 This is the distance within which the table can move when it returns to origin.  
Make sure that workpieces mounted on the table do not interfere with other workpieces or the facilities around the table.
- \*3 Position after returning to origin
- \*4 [ ] for when the direction of return to origin has changed
- \*5 When using the body bottom positioning pin holes, do not simultaneously use the housing B bottom pin hole.

### Dimensions

Model	L		A	B	n	D	E	F	G	H
	Without lock	With lock								
LEFS16F□-50□	247	289	56	130	4	—	—	40	15	25
LEFS16F□-100□	297	339	106	180	4	—	—		80	50
LEFS16F□-150□	347	389	156	230	4	—	—		80	50
LEFS16F□-200□	397	439	206	280	6	2	200		180	50
LEFS16F□-250□	447	489	256	330	6	2	200		180	50
LEFS16F□-300□	497	539	306	380	8	3	300		280	50
LEFS16F□-350□	547	589	356	430	8	3	300		280	50
LEFS16F□-400□	597	639	406	480	10	4	400		380	50
LEFS16F□-450□	647	689	456	530	10	4	400		380	50
LEFS16F□-500□	697	739	506	580	12	5	500		480	50



## Dimensions: In-line Motor

### LEFS25F

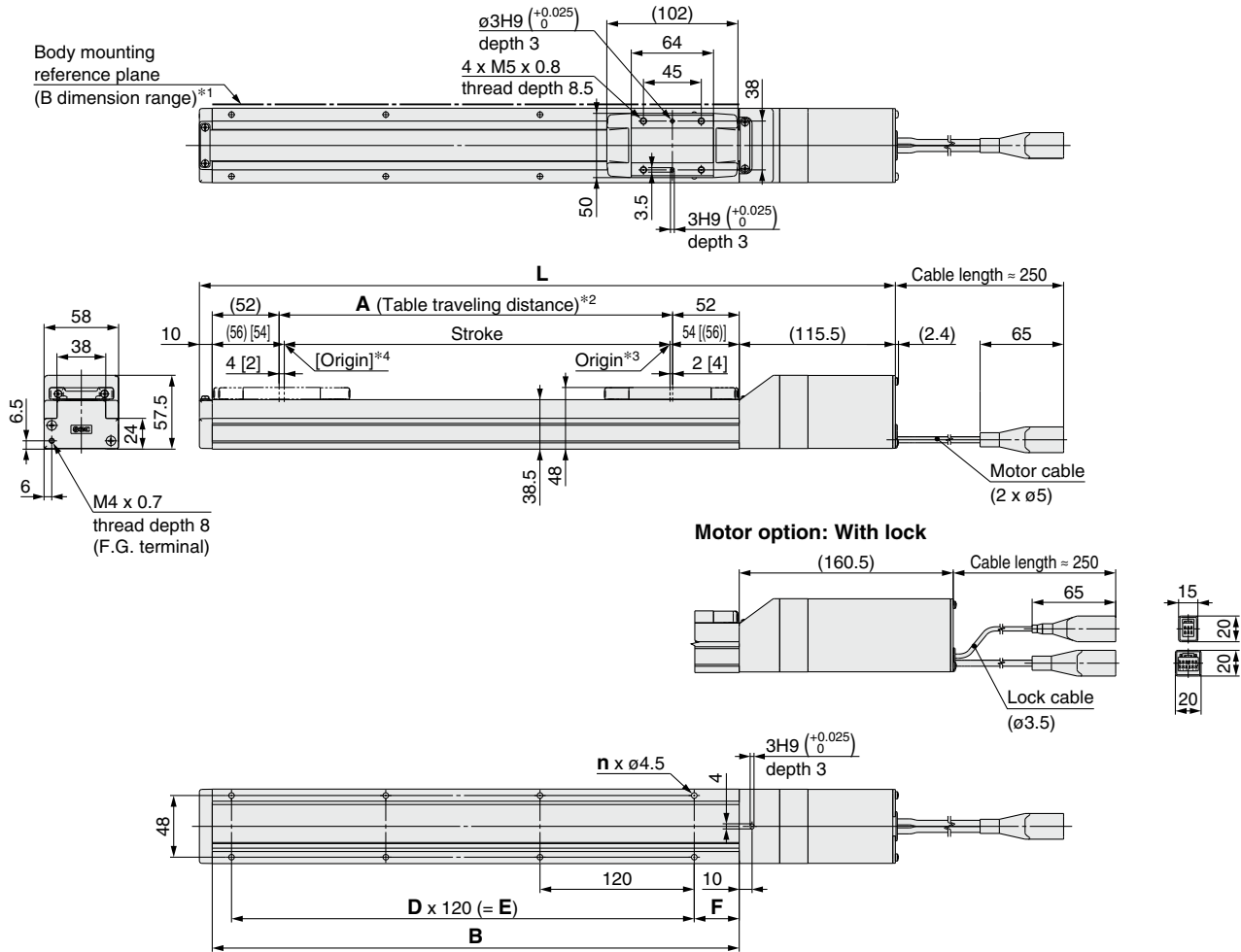

- \*1 When mounting the actuator using the body mounting reference plane, set the height of the opposite surface or pin to be 3 mm or more because of round chamfering. (Recommended height: 5 mm)  
 In addition, be aware that surfaces other than the body mounting reference plane (B dimension range) may slightly protrude from the body mounting reference plane. Be sure to provide a clearance of 1 mm or more to avoid interference with workpieces, facilities, etc.
- \*2 This is the distance within which the table can move when it returns to origin.  
 Make sure that workpieces mounted on the table do not interfere with other workpieces or the facilities around the table.
- \*3 Position after returning to origin
- \*4 [ ] for when the direction of return to origin has changed

### Dimensions

Model	L		A	B	n	D	E	F
	Without lock	With lock						
LEFS25F□-50□	285.5	330.5	56	160	4	—	—	20
LEFS25F□-100□	335.5	380.5	106	210	4	—	—	35
LEFS25F□-150□	385.5	430.5	156	260	4	—	—	
LEFS25F□-200□	435.5	480.5	206	310	6	2	240	
LEFS25F□-250□	485.5	530.5	256	360	6	2	240	
LEFS25F□-300□	535.5	580.5	306	410	8	3	360	
LEFS25F□-350□	585.5	630.5	356	460	8	3	360	
LEFS25F□-400□	635.5	680.5	406	510	8	3	360	
LEFS25F□-450□	685.5	730.5	456	560	10	4	480	
LEFS25F□-500□	735.5	780.5	506	610	10	4	480	
LEFS25F□-550□	785.5	830.5	556	660	12	5	600	
LEFS25F□-600□	835.5	880.5	606	710	12	5	600	
LEFS25F□-650□	885.5	930.5	656	760	12	5	600	
LEFS25F□-700□	935.5	980.5	706	810	14	6	720	
LEFS25F□-750□	985.5	1030.5	756	860	14	6	720	
LEFS25F□-800□	1035.5	1080.5	806	910	16	7	840	

## Dimensions: In-line Motor

### LEFS25F

#### Positioning pin hole\*1 (Option): Body bottom

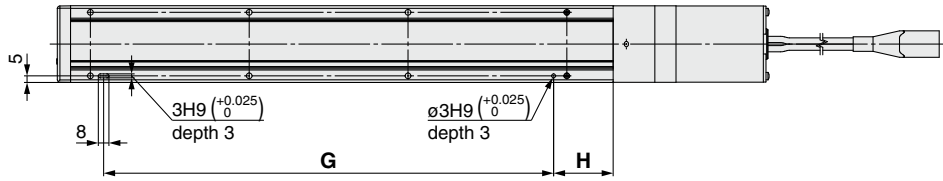

\*1 When using the body bottom positioning pin holes, do not simultaneously use the housing B bottom pin hole.

#### With auto switch (Option)

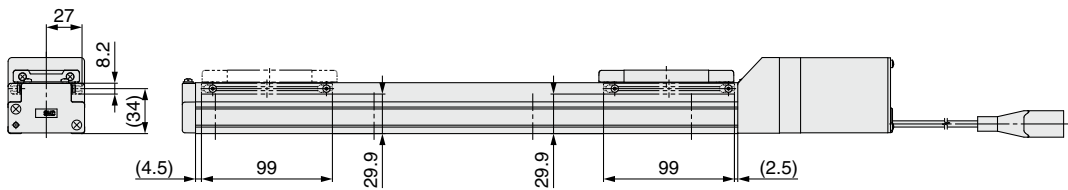

\* For strokes of 99 mm or less, only 2 auto switch mounting brackets can be installed on the motor side.

#### Dimensions [mm]

Model	G	H
LEFS25F□-50□	100	30
LEFS25F□-100□	100	45
LEFS25F□-150□	100	45
LEFS25F□-200□	220	45
LEFS25F□-250□	220	45
LEFS25F□-300□	340	45
LEFS25F□-350□	340	45
LEFS25F□-400□	340	45
LEFS25F□-450□	460	45
LEFS25F□-500□	460	45
LEFS25F□-550□	580	45
LEFS25F□-600□	580	45
LEFS25F□-650□	580	45
LEFS25F□-700□	700	45
LEFS25F□-750□	700	45
LEFS25F□-800□	820	45

## Dimensions: In-line Motor

### LEFS32F

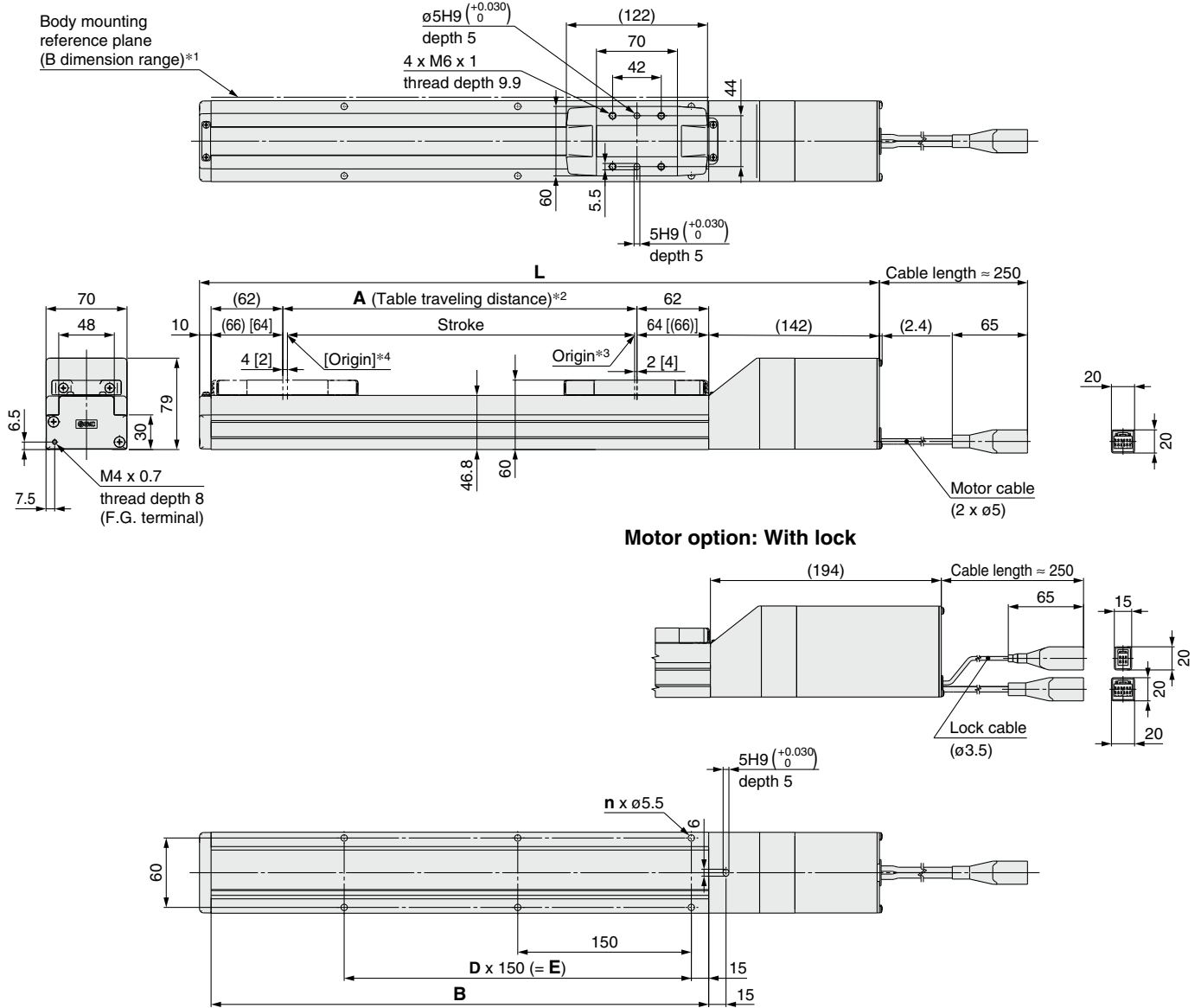

\*1 When mounting the actuator using the body mounting reference plane, set the height of the opposite surface or pin to be 3 mm or more because of round chamfering. (Recommended height: 5 mm)

In addition, be aware that surfaces other than the body mounting reference plane (B dimension range) may slightly protrude from the body mounting reference plane. Be sure to provide a clearance of 1 mm or more to avoid interference with workpieces, facilities, etc.

\*2 This is the distance within which the table can move when it returns to origin.

Make sure that workpieces mounted on the table do not interfere with other workpieces or the facilities around the table.

\*3 Position after returning to origin

\*4 [ ] for when the direction of return to origin has changed

### Dimensions

Model	L		A	B	n	D	E
	Without lock	With lock					
LEFS32F□-50□	332	384	56	180	4	—	—
LEFS32F□-100□	382	434	106	230	4	—	—
LEFS32F□-150□	432	484	156	280	4	—	—
LEFS32F□-200□	482	534	206	330	6	2	300
LEFS32F□-250□	532	584	256	380	6	2	300
LEFS32F□-300□	582	634	306	430	6	2	300
LEFS32F□-350□	632	684	356	480	8	3	450
LEFS32F□-400□	682	734	406	530	8	3	450
LEFS32F□-450□	732	784	456	580	8	3	450
LEFS32F□-500□	782	834	506	630	10	4	600
LEFS32F□-550□	832	884	556	680	10	4	600
LEFS32F□-600□	882	934	606	730	10	4	600
LEFS32F□-650□	932	984	656	780	12	5	750
LEFS32F□-700□	982	1034	706	830	12	5	750
LEFS32F□-750□	1032	1084	756	880	12	5	750
LEFS32F□-800□	1082	1134	806	930	14	6	900
LEFS32F□-850□	1132	1184	856	980	14	6	900
LEFS32F□-900□	1182	1234	906	1030	14	6	900
LEFS32F□-950□	1232	1284	956	1080	16	7	1050
LEFS32F□-1000□	1282	1334	1006	1130	16	7	1050

## Dimensions: In-line Motor

### LEFS32F

Positioning pin hole\*1 (Option): Body bottom

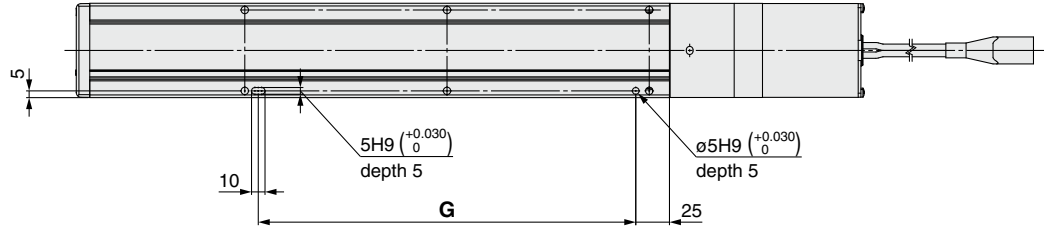

\*1 When using the body bottom positioning pin holes, do not simultaneously use the housing B bottom pin hole.

With auto switch (Option)

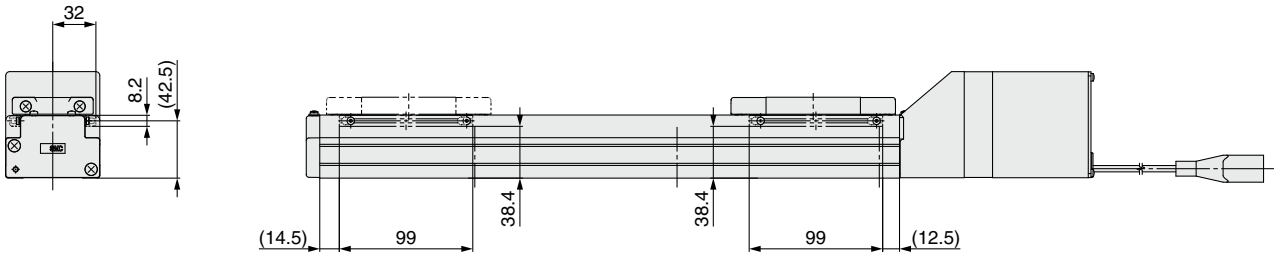

\* For strokes of 99 mm or less, only 2 auto switch mounting brackets can be installed on the motor side.

### Dimensions

Model	[mm]
	<b>G</b>
LEFS32F□-50□	130
LEFS32F□-100□	130
LEFS32F□-150□	130
LEFS32F□-200□	280
LEFS32F□-250□	280
LEFS32F□-300□	280
LEFS32F□-350□	430
LEFS32F□-400□	430
LEFS32F□-450□	430
LEFS32F□-500□	580
LEFS32F□-550□	580
LEFS32F□-600□	580
LEFS32F□-650□	730
LEFS32F□-700□	730
LEFS32F□-750□	730
LEFS32F□-800□	880
LEFS32F□-850□	880
LEFS32F□-900□	880
LEFS32F□-950□	1030
LEFS32F□-1000□	1030

## Dimensions: In-line Motor

### LEFS40F

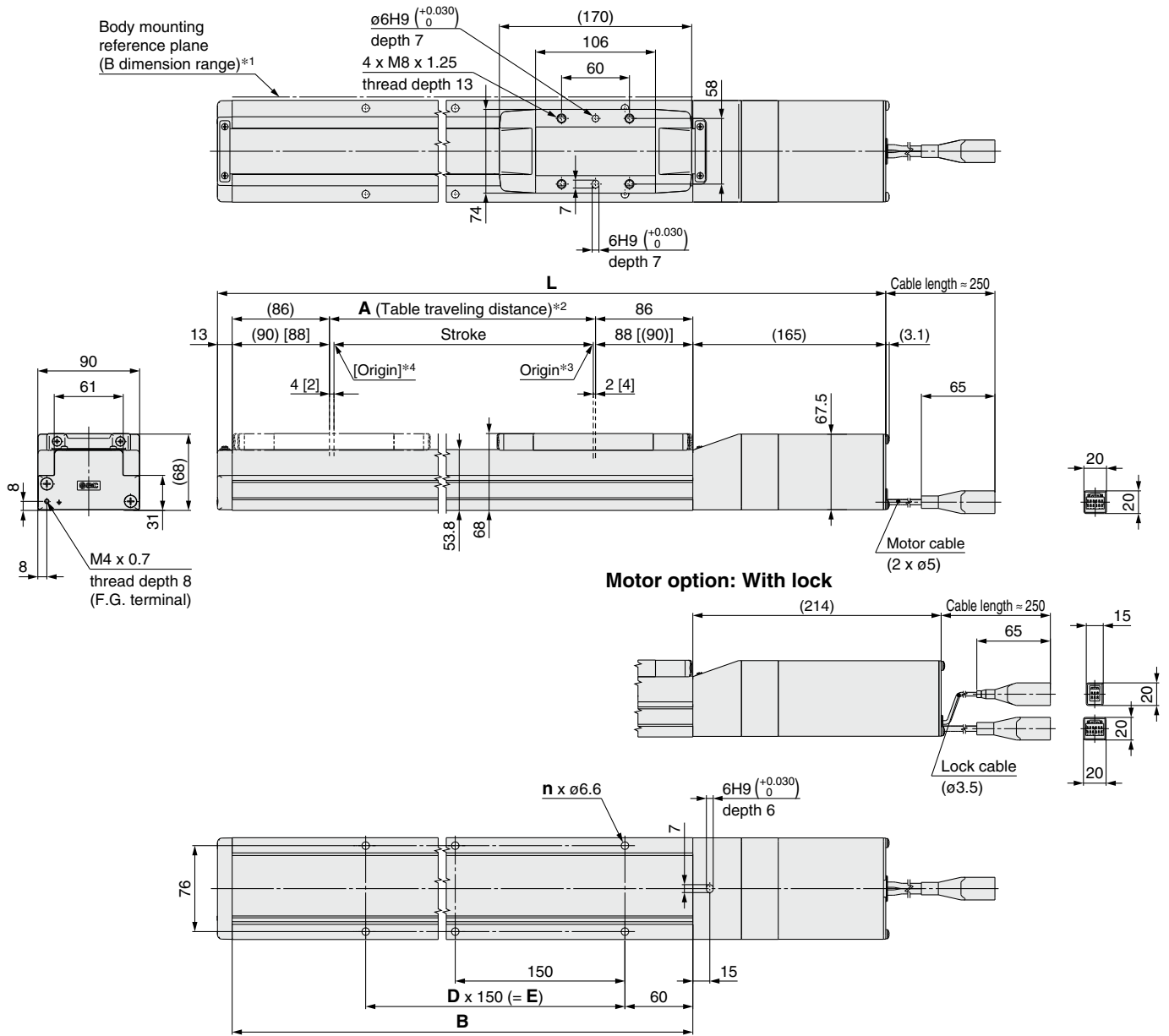

\*1 When mounting the actuator using the body mounting reference plane, set the height of the opposite surface or pin to be 3 mm or more because of round chamfering. (Recommended height: 5 mm)

In addition, be aware that surfaces other than the body mounting reference plane (B dimension range) may slightly protrude from the body mounting reference plane. Be sure to provide a clearance of 1 mm or more to avoid interference with workpieces, facilities, etc.

\*2 This is the distance within which the table can move when it returns to origin.

Make sure that workpieces mounted on the table do not interfere with other workpieces or the facilities around the table.

\*3 Position after returning to origin

\*4 [ ] for when the direction of return to origin has changed

### Dimensions

Model	L		A	B	n	D	E
	Without lock	With lock					
LEFS40F□-150□	506	555	156	328	4	—	150
LEFS40F□-200□	556	605	206	378	6	2	300
LEFS40F□-250□	606	655	256	428	6	2	300
LEFS40F□-300□	656	705	306	478	6	2	300
LEFS40F□-350□	706	755	356	528	8	3	450
LEFS40F□-400□	756	805	406	578	8	3	450
LEFS40F□-450□	806	855	456	628	8	3	450
LEFS40F□-500□	856	905	506	678	10	4	600
LEFS40F□-550□	906	955	556	728	10	4	600
LEFS40F□-600□	956	1005	606	778	10	4	600
LEFS40F□-650□	1006	1055	656	828	12	5	750
LEFS40F□-700□	1056	1105	706	878	12	5	750
LEFS40F□-750□	1106	1155	756	928	12	5	750
LEFS40F□-800□	1156	1205	806	978	14	6	900
LEFS40F□-850□	1206	1255	856	1028	14	6	900
LEFS40F□-900□	1256	1305	906	1078	14	6	900
LEFS40F□-950□	1306	1355	956	1128	16	7	1050
LEFS40F□-1000□	1356	1405	1006	1178	16	7	1050
LEFS40F□-1100□	1456	1505	1106	1278	18	8	1200
LEFS40F□-1200□	1556	1605	1206	1378	18	8	1200

## Dimensions: In-line Motor

### LEFS40F

Positioning pin hole\*1 (Option): Body bottom

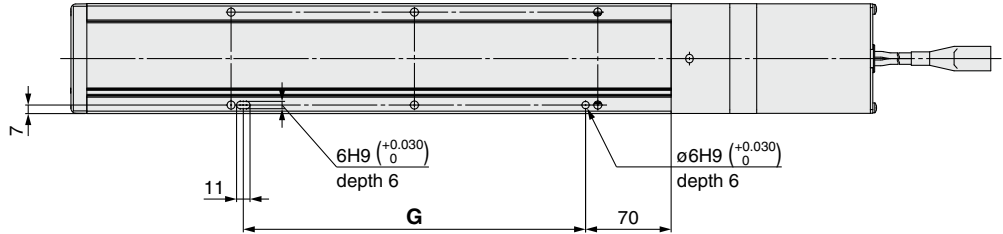

\*1 When using the body bottom positioning pin holes, do not simultaneously use the housing B bottom pin hole.

With auto switch (Option)

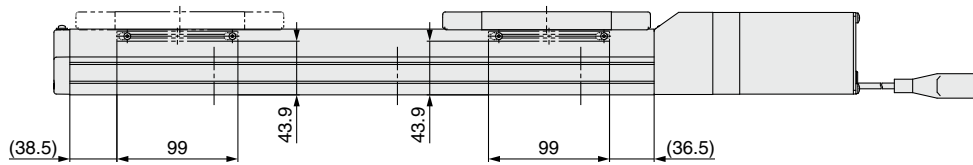
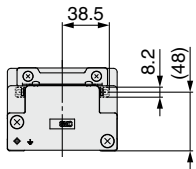

Dimensions [mm]	
Model	G
LEFS40F□-150□	130
LEFS40F□-200□	280
LEFS40F□-250□	280
LEFS40F□-300□	280
LEFS40F□-350□	430
LEFS40F□-400□	430
LEFS40F□-450□	430
LEFS40F□-500□	580
LEFS40F□-550□	580
LEFS40F□-600□	580
LEFS40F□-650□	730
LEFS40F□-700□	730
LEFS40F□-750□	730
LEFS40F□-800□	880
LEFS40F□-850□	880
LEFS40F□-900□	880
LEFS40F□-950□	1030
LEFS40F□-1000□	1030
LEFS40F□-1100□	1180
LEFS40F□-1200□	1180

# LEFS□F Series Auto Switch Mounting

## Auto Switch Mounting Position

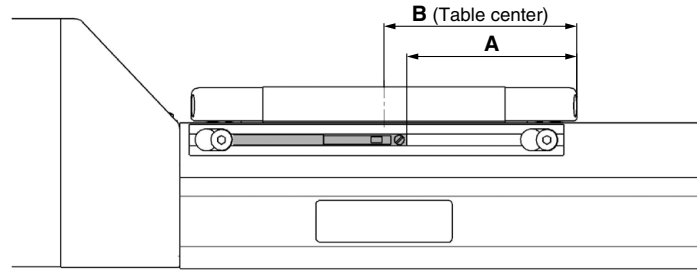

Model	Size	A	B	Operating range
LEFS	25	45	51	4.9
	32	55	61	3.9
	40	79	85	5.3

- \* The applicable auto switch is D-M9 (N/P/B) (W) (M/L/Z).
- \* The operating range is a guideline including hysteresis, not meant to be guaranteed. There may be large variations depending on the ambient environment.
- \* Adjust the auto switch after confirming the operating conditions in the actual setting.

## Auto Switch Mounting

Rotate the bolts for the auto switch mounting bracket three to four times to loosen them (Removing them is not required), and slide and remove the auto switch mounting bracket. Then, insert a switch into the groove on the mounting bracket.

As the mounting bolts for installing the product body interfere with the auto switch mounting bracket, mount the auto switch mounting bracket after installing the product body. After setting in the mounting position, use a flat head watchmaker's screwdriver to tighten the auto switch mounting screw that is included.

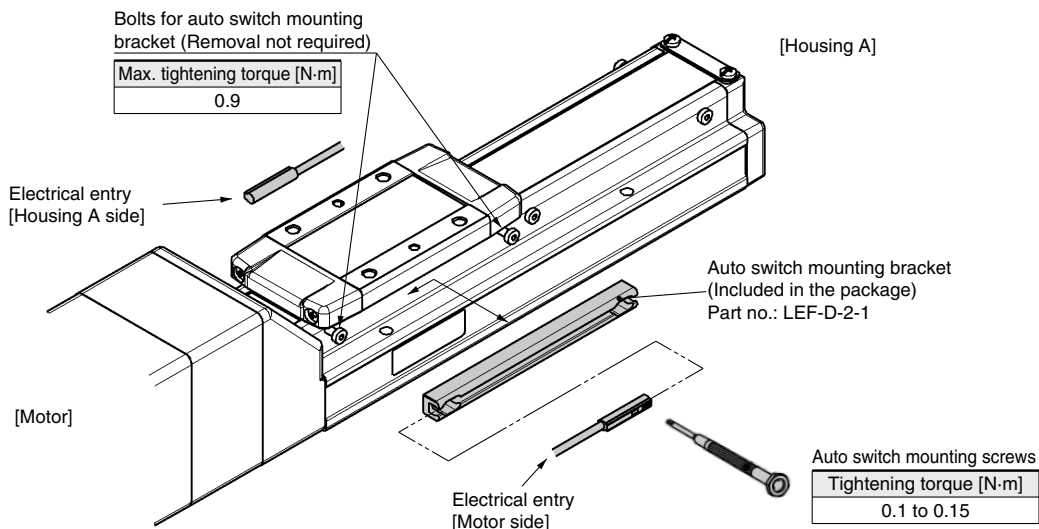

- \* The applicable auto switch is D-M9 (N/P/B) (W) (M/L/Z).
- \* The direction of the lead wire entry is specified. If it is mounted in the opposite direction, the auto switch may malfunction.
- \* When tightening the auto switch mounting screw (included with the auto switch), use a watchmaker's screwdriver with a handle diameter of about 5 to 6 mm.
- \* If more than two auto switch mounting brackets are required, please order them separately. All eight bolts for attaching the auto switch mounting bracket at the stroke end are tightened into the body when the product is shipped. For 50-mm stroke type, only four bolts are tightened on the motor side.

# Solid State Auto Switch Direct Mounting Type D-M9N/D-M9P/D-M9B



Refer to the SMC website for details on products that are compliant with international standards.

## Grommet

- 2-wire load current is reduced (2.5 to 40 mA).
- Using flexible cable as standard spec.



## Caution

### Precautions

Fix the auto switch with the existing screw installed on the auto switch body. The auto switch may be damaged if a screw other than the one supplied is used.

## Auto Switch Specifications

PLC: Programmable Logic Controller

D-M9□, D-M9□V (With indicator light)			
Auto switch model	D-M9N	D-M9P	D-M9B
Electrical entry direction	In-line		
Wiring type	3-wire		2-wire
Output type	NPN	PNP	—
Applicable load	IC circuit, Relay, PLC		24 VDC relay, PLC
Power supply voltage	5, 12, 24 VDC (4.5 to 28 V)		—
Current consumption	10 mA or less		—
Load voltage	28 VDC or less	—	24 VDC (10 to 28 VDC)
Load current	40 mA or less		2.5 to 40 mA
Internal voltage drop	0.8 V or less at 10 mA (2 V or less at 40 mA)		4 V or less
Leakage current	100 μA or less at 24 VDC		0.8 mA or less
Indicator light	Red LED illuminates when turned ON.		
Standard	CE marking, RoHS		

## Oilproof Flexible Heavy-duty Lead Wire Specifications

Auto switch model		D-M9N	D-M9P	D-M9B
Sheath	Outside diameter [mm]	2.6		
Insulator	Number of cores	3 cores (Brown/Blue/Black)		2 cores (Brown/Blue)
	Outside diameter [mm]	0.88		
Conductor	Effective area [mm <sup>2</sup> ]	0.15		
	Strand diameter [mm]	0.05		
Min. bending radius [mm] (Reference values)		17		

\* Refer to the **Web Catalog** for solid state auto switch common specifications.

\* Refer to the **Web Catalog** for lead wire lengths.

## Weight

[g]

Auto switch model		D-M9N	D-M9P	D-M9B
Lead wire length	0.5 m (Nil)	8	—	7
	1 m (M)	14	—	13
	3 m (L)	41	—	38
	5 m (Z)	68	—	63

## Dimensions

[mm]

### D-M9□

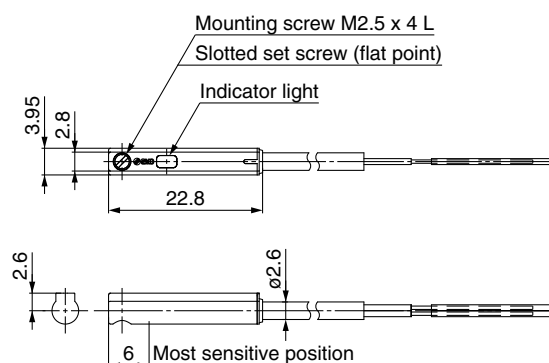



# Normally Closed Solid State Auto Switch Direct Mounting Type

## D-M9NE(V)/D-M9PE(V)/D-M9BE(V)

Refer to the SMC website for details on products that are compliant with international standards.

PLC: Programmable Logic Controller

### Grommet

- Output signal turns on when no magnetic force is detected.
- Can be used for the actuator adopted by the solid state auto switch D-M9 series (excluding special order products)



### Caution

#### Precautions

Fix the auto switch with the existing screw installed on the auto switch body. The auto switch may be damaged if a screw other than the one supplied is used.

### Auto Switch Specifications

D-M9□E, D-M9□EV (With indicator light)						
Auto switch model	D-M9NE	D-M9NEV	D-M9PE	D-M9PEV	D-M9BE	D-M9BEV
Electrical entry direction	In-line	Perpendicular	In-line	Perpendicular	In-line	Perpendicular
Wiring type	3-wire				2-wire	
Output type	NPN		PNP		—	
Applicable load	IC circuit, Relay, PLC				24 VDC relay, PLC	
Power supply voltage	5, 12, 24 VDC (4.5 to 28 V)				—	
Current consumption	10 mA or less				—	
Load voltage	28 VDC or less		—		24 VDC (10 to 28 VDC)	
Load current	40 mA or less				2.5 to 40 mA	
Internal voltage drop	0.8 V or less at 10 mA (2 V or less at 40 mA)				4 V or less	
Leakage current	100 μA or less at 24 VDC				0.8 mA or less	
Indicator light	Red LED illuminates when turned ON.					
Standard	CE marking, RoHS					

### Oilproof Flexible Heavy-duty Lead Wire Specifications

Auto switch model	D-M9NE(V)	D-M9PE(V)	D-M9BE(V)
Sheath	Outside diameter [mm]		
	2.6		
Insulator	Number of cores		2 cores (Brown/Blue)
	Outside diameter [mm]		0.88
Conductor	Effective area [mm <sup>2</sup> ]		0.15
	Strand diameter [mm]		0.05
Min. bending radius [mm] (Reference values)			
17			

- \* Refer to the **Web Catalog** for solid state auto switch common specifications.
- \* Refer to the **Web Catalog** for lead wire lengths.

### Weight

Auto switch model	D-M9NE(V)	D-M9PE(V)	D-M9BE(V)
Lead wire length	0.5 m (Nil)	8	7
	1 m (M)*1	14	13
	3 m (L)	41	38
	5 m (Z)*1	68	63

\*1 The 1 m and 5 m options are produced upon receipt of order.

### Dimensions

#### D-M9□E

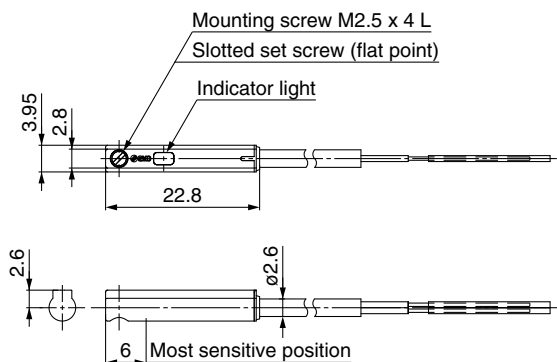

#### D-M9□EV

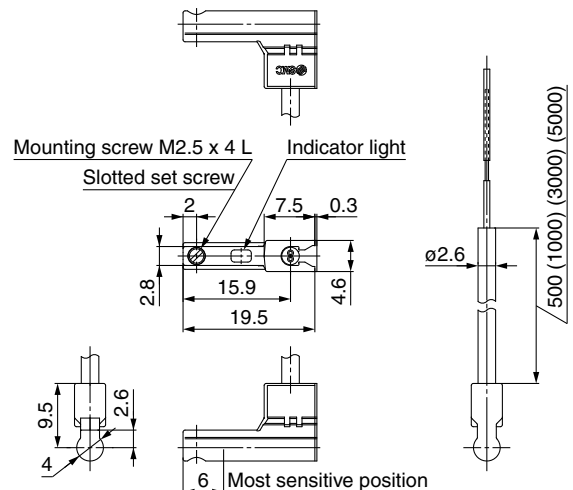

# 2-Color Indicator Solid State Auto Switch Direct Mounting Type D-M9NW/D-M9PW/D-M9BW



Refer to the SMC website for details on products that are compliant with international standards.

## Grommet

- 2-wire load current is reduced (2.5 to 40 mA).
- Using flexible cable as standard spec.
- The proper operating range can be determined by the color of the light. (Red → Green ← Red)



## Caution

### Precautions

Fix the auto switch with the existing screw installed on the auto switch body. The auto switch may be damaged if a screw other than the one supplied is used.

## Auto Switch Specifications

PLC: Programmable Logic Controller

D-M9□W, D-M9□WV (With indicator light)			
Auto switch model	D-M9NW	D-M9PW	D-M9BW
Electrical entry direction	In-line		
Wiring type	3-wire		2-wire
Output type	NPN	PNP	—
Applicable load	IC circuit, Relay, PLC		24 VDC relay, PLC
Power supply voltage	5, 12, 24 VDC (4.5 to 28 V)		—
Current consumption	10 mA or less		
Load voltage	28 VDC or less	—	24 VDC (10 to 28 VDC)
Load current	40 mA or less		2.5 to 40 mA
Internal voltage drop	0.8 V or less at 10 mA (2 V or less at 40 mA)		4 V or less
Leakage current	100 μA or less at 24 VDC		0.8 mA or less
Indicator light	Operating range ..... Red LED illuminates. Proper operating range ..... Green LED illuminates.		
Standard	CE marking, RoHS		

## Oilproof Flexible Heavy-duty Lead Wire Specifications

Auto switch model		D-M9NW	D-M9PW	D-M9BW
Sheath	Outside diameter [mm]	2.6		
Insulator	Number of cores	3 cores (Brown/Blue/Black)		2 cores (Brown/Blue)
	Outside diameter [mm]	0.88		
Conductor	Effective area [mm <sup>2</sup> ]	0.15		
	Strand diameter [mm]	0.05		
Min. bending radius [mm] (Reference values)		17		

- \* Refer to the **Web Catalog** for solid state auto switch common specifications.
- \* Refer to the **Web Catalog** for lead wire lengths.

## Weight

[g]

Auto switch model		D-M9NW	D-M9PW	D-M9BW
Lead wire length	0.5 m (Nil)	8	7	7
	1 m (M)	14	13	13
	3 m (L)	41	38	38
	5 m (Z)	68	63	63

## Dimensions

[mm]

### D-M9□W

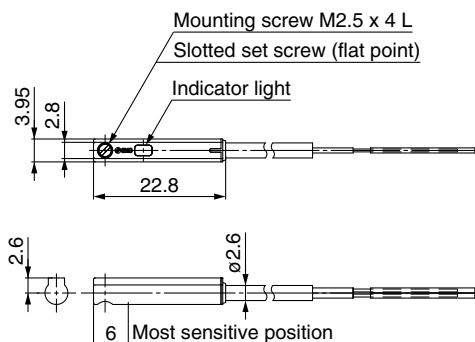

# Electric Actuators

## High Performance Rod Type

LEY□F Series

p. 35

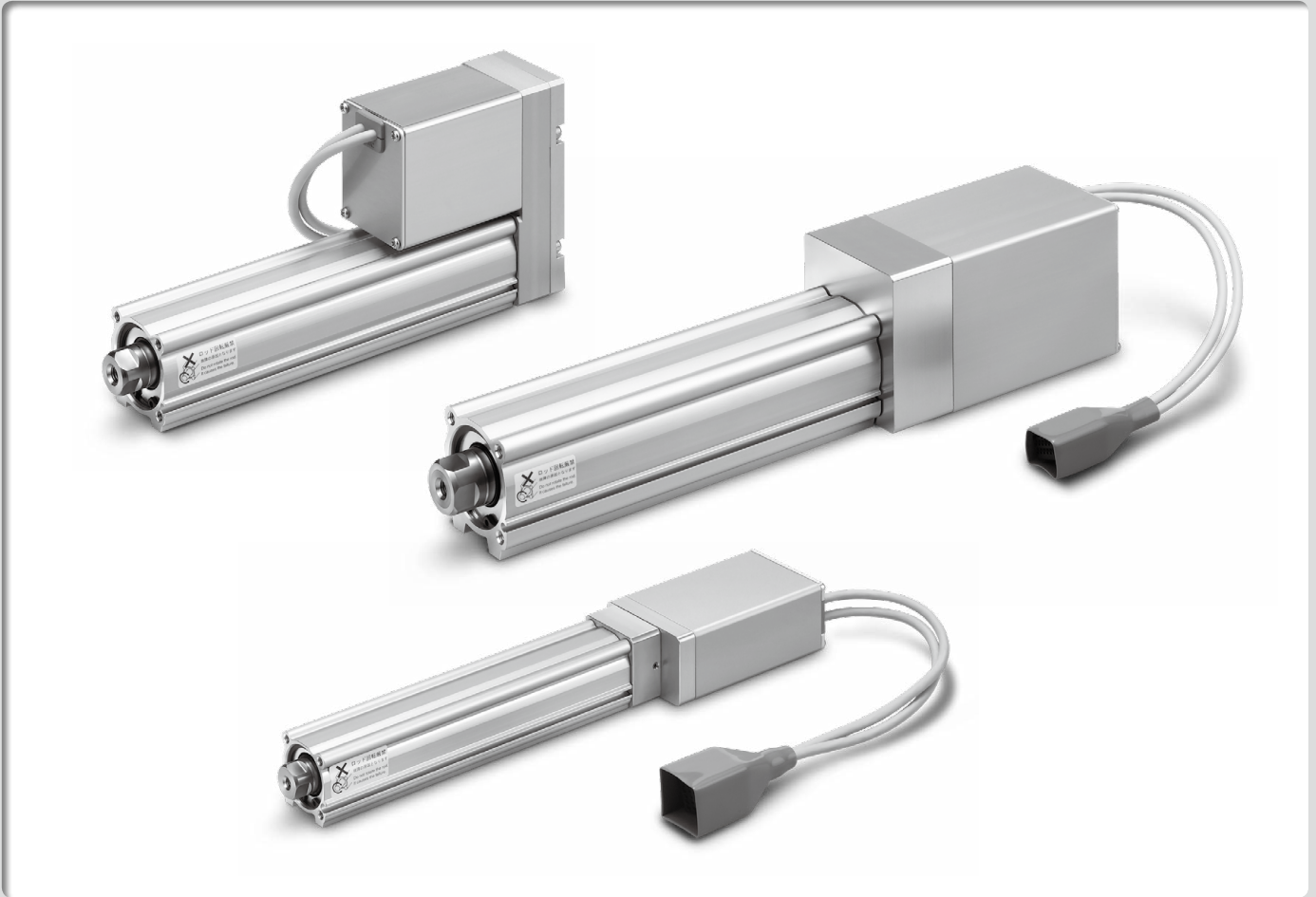

Controllers p. 60

Model Selection

LEFS□F Series

LEY□F Series

Auto Switch

JXC5H/6H Series

JXCEH/9H/PH Series

# Model Selection

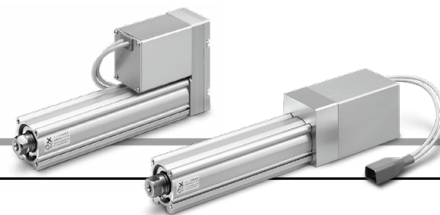

## Selection Procedure

### Positioning Control Selection Procedure



### Selection Example

#### Operating conditions

- Workpiece mass: 2 [kg]
- Speed: 100 [mm/s]
- Acceleration/Deceleration: 5000 [mm/s<sup>2</sup>]
- Stroke: 200 [mm]
- Workpiece mounting condition: Vertical upward downward transfer

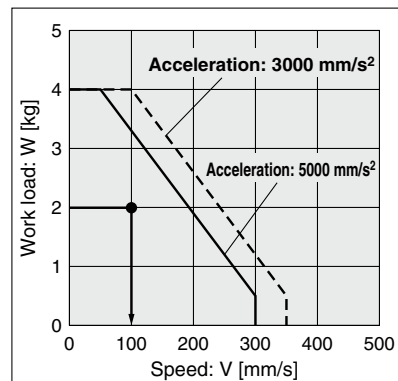

<Speed-Vertical work load graph>  
(LEY16/Step motor)

#### Step 1 Check the work load-speed. <Speed-Vertical work load graph>

Select a model based on the workpiece mass and speed while referencing the speed-vertical work load graph.

Selection example) The **LEY16DFB** can be temporarily selected as a possible candidate based on the graph shown on the right side.

\* It is necessary to mount a guide outside the actuator when used for horizontal transfer. When selecting the target model, refer to the horizontal work load in the specifications on page 45 and the precautions.

#### Step 2 Check the cycle time.

Calculate the cycle time using the following calculation method.

##### Cycle time:

T can be found from the following equation.

$$T = T1 + T2 + T3 + T4 \text{ [s]}$$

- T1: Acceleration time and T3: Deceleration time can be found by the following equation.

$$T1 = V/a1 \text{ [s]} \quad T3 = V/a2 \text{ [s]}$$

- T2: Constant speed time can be found from the following equation.

$$T2 = \frac{L - 0.5 \cdot V \cdot (T1 + T3)}{V} \text{ [s]}$$

- T4: Settling time varies depending on the conditions such as actuator types, load, and in position of the step data. Reference value for settling time: 0.15 s or less. The following value is used for this calculation.

$$T4 = 0.15 \text{ [s]}$$

Calculation example)

T1 to T4 can be calculated as follows.

$$T1 = V/a1 = 100/5000 = 0.02 \text{ [s]}, \quad T3 = V/a2 = 100/5000 = 0.02 \text{ [s]}$$

$$T2 = \frac{L - 0.5 \cdot V \cdot (T1 + T3)}{V} = \frac{200 - 0.5 \cdot 100 \cdot (0.02 + 0.02)}{100} = 1.98 \text{ [s]}$$

$$T4 = 0.15 \text{ [s]}$$

The cycle time can be found as follows.

$$T = T1 + T2 + T3 + T4 = 0.02 + 1.98 + 0.02 + 0.15 = 2.17 \text{ [s]}$$

Based on the above calculation result, the **LEY16DFB-200** should be selected.

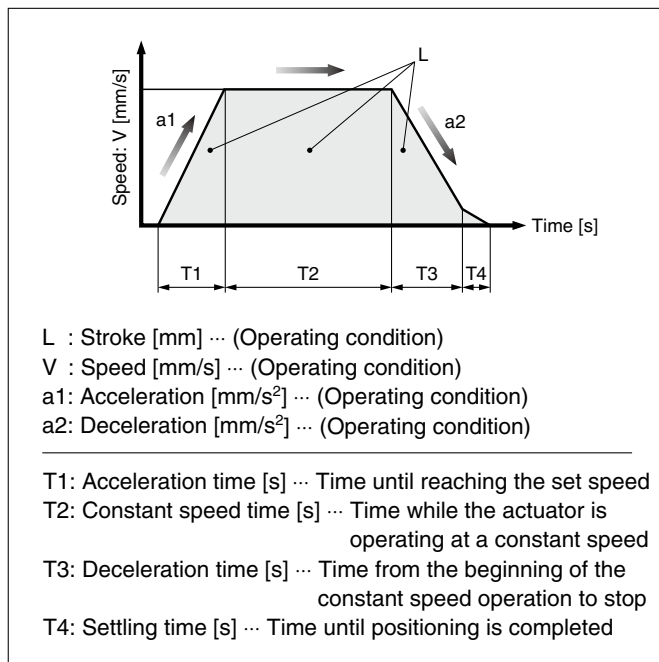

## Selection Procedure

### Pushing Control Selection Procedure



\* The duty ratio is a ratio of the operation time in one cycle.

### Selection Example

#### Operating conditions

- Mounting condition: Horizontal (pushing)
- Attachment weight: 0.2 [kg]
- Pushing force: 60 [N]
- Duty ratio: 20 [%]
- Speed: 100 [mm/s]
- Stroke: 200 [mm]

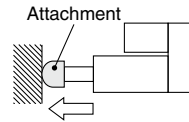

#### Step 1 Check the duty ratio.

##### <Conversion table of pushing force–duty ratio>

Select the [Pushing force] from the duty ratio while referencing the conversion table of pushing force–duty ratio.

Selection example)

Based on the table below,

- Duty ratio: 20 [%]

The pushing force set value will be 70 [%].

##### <Conversion table of pushing force–duty ratio>

(LEY16/Step motor)

Pushing force set value [%]	Duty ratio [%]	Continuous pushing time [min]
40 or less	100	—
50	70	12 or less
70	20	1.3 or less
85	15	0.8 or less

\* [Pushing force set value] is one of the step data input to the controller.

\* [Continuous pushing time] is the time that the actuator can continuously keep pushing.

#### Step 2 Check the pushing force.

##### <Force conversion graph>

Select a model based on the pushing force set value and force while referencing the force conversion graph.

Selection example)

Based on the graph shown on the right side,

- Pushing force: 60 [N]
- Pushing force set value: 70 [%]

The LEY16DFB can be temporarily selected as a possible candidate.

#### Step 3 Check the lateral load on the rod end.

##### <Graph of allowable lateral load on the rod end>

Confirm the allowable lateral load on the rod end of the actuator: LEY16□, which has been selected temporarily while referencing the graph of allowable lateral load on the rod end.

Selection example)

Based on the graph shown on the right side,

- Attachment weight: 0.2 [kg] ≈ 2 [N]
- Product stroke: 200 [mm]

The lateral load on the rod end is in the allowable range.

**Based on the above calculation result, the LEY16DFB-200 should be selected.**

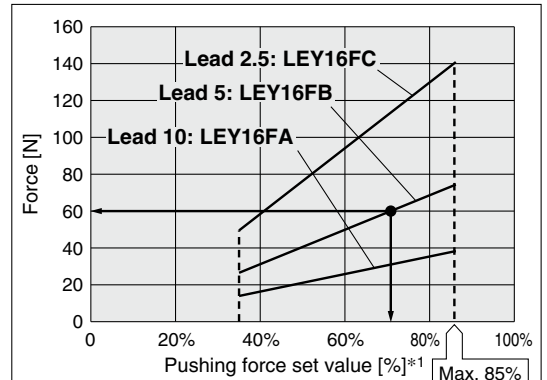
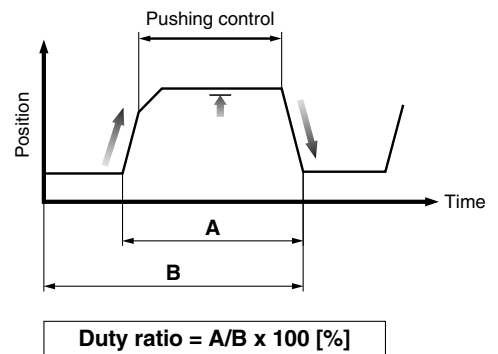

<Force conversion graph>  
(LEY16/Step motor)

\*1 Set values for the controller

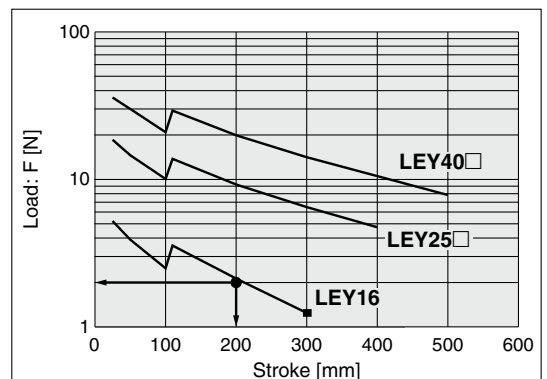

<Graph of allowable lateral load on the rod end>

## Speed-Work Load Graph (Guide)

\* The following graphs show the values when the external guide is used together, and the moving force is 100%.

### LEY16□FA

#### Horizontal/Lead 10

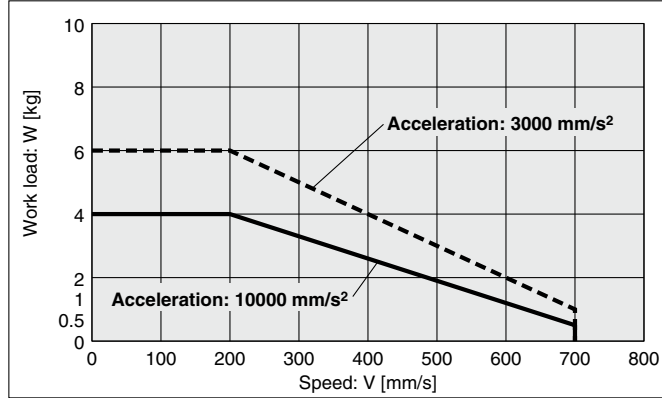

#### Vertical/Lead 10

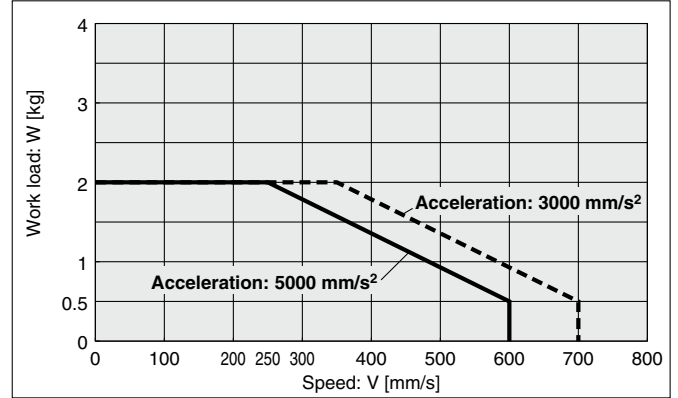

### LEY16□FB

#### Horizontal/Lead 5

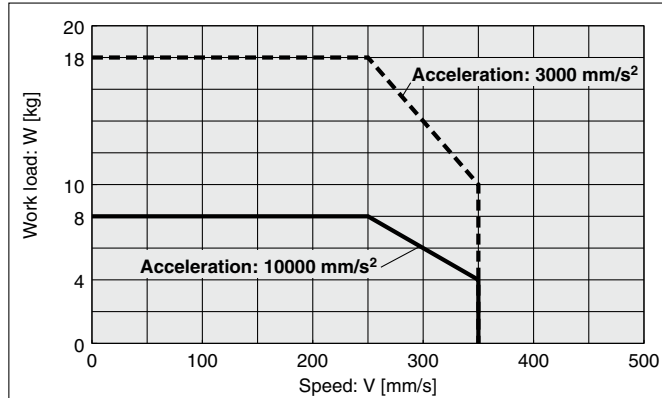

#### Vertical/Lead 5

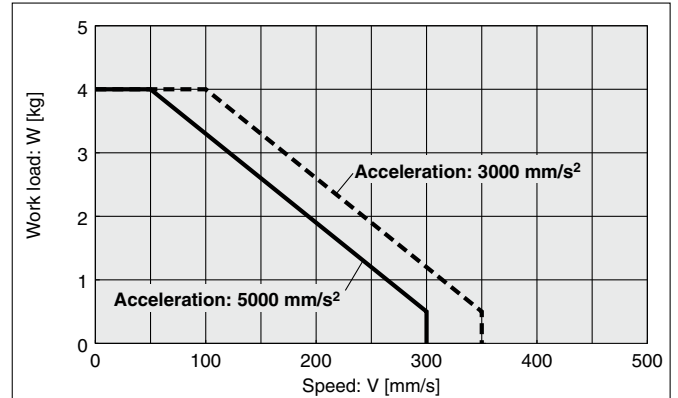

### LEY16□FC

#### Horizontal/Lead 2.5

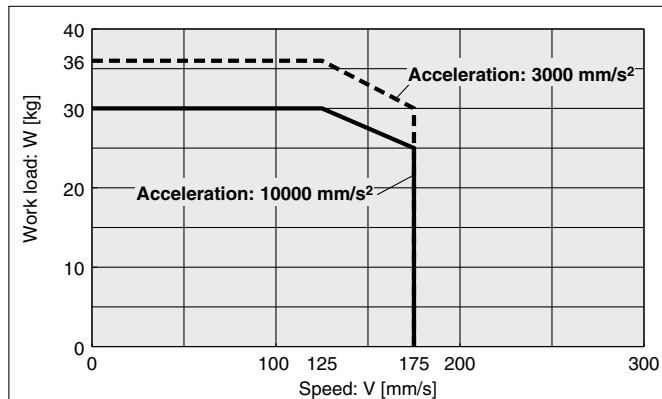

#### Vertical/Lead 2.5

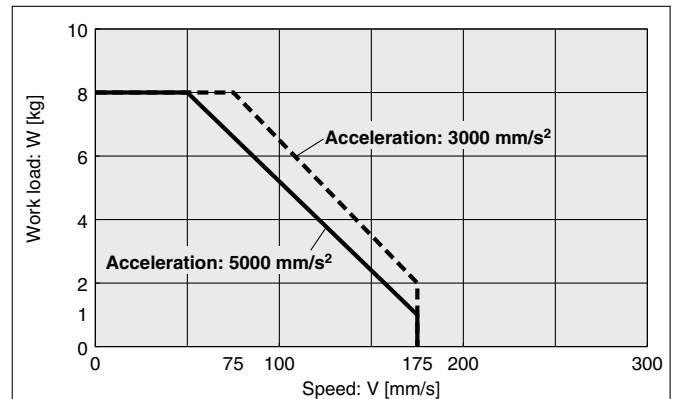

**Operating temperature:** Use products with a duty ratio of 100% or less when the temperature is below 30°C and with a duty ratio of 35% or less when the temperature exceeds 30°C.

**Speed-Work Load Graph (Guide)**

\* The following graphs show the values when the external guide is used together, and the moving force is 100%.

**LEY25□FA**

**Horizontal/Lead 12**

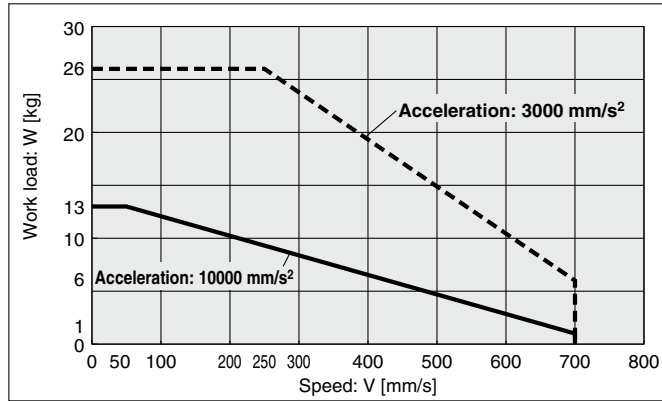

**Vertical/Lead 12**

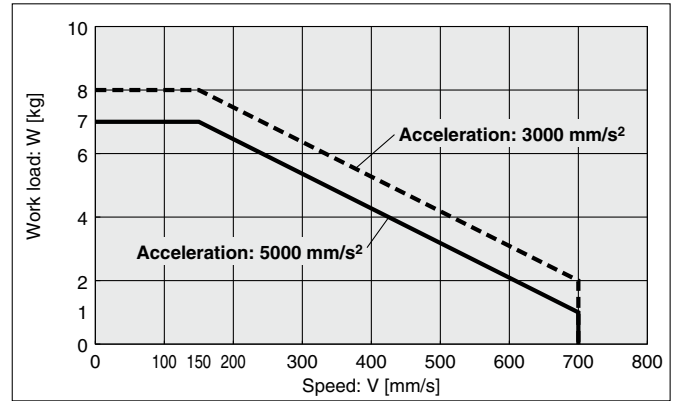

**LEY25□FB**

**Horizontal/Lead 6**

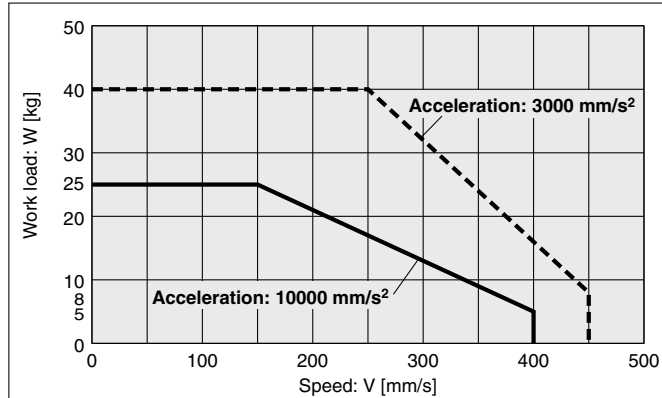

**Vertical/Lead 6**

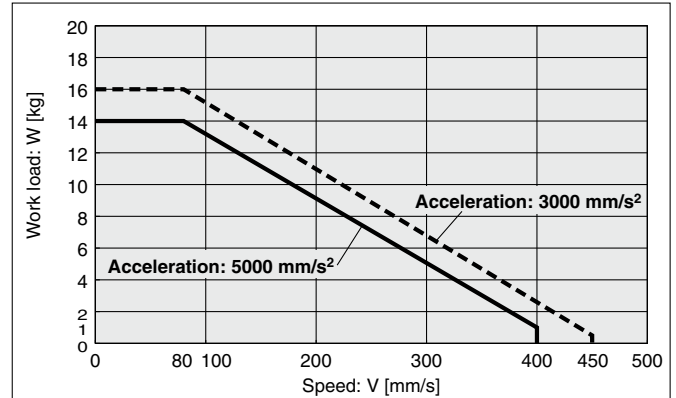

**LEY25□FC**

**Horizontal/Lead 3**

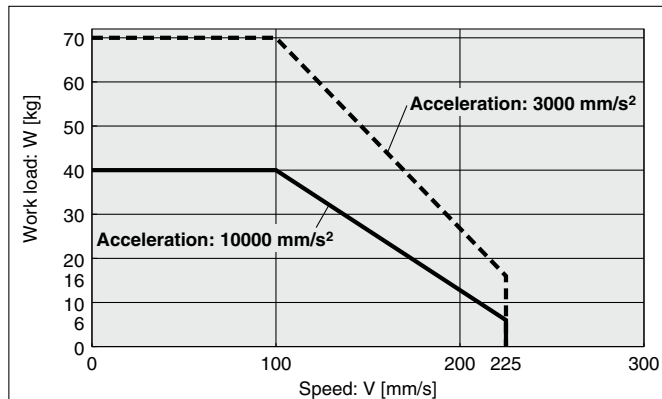

**Vertical/Lead 3**

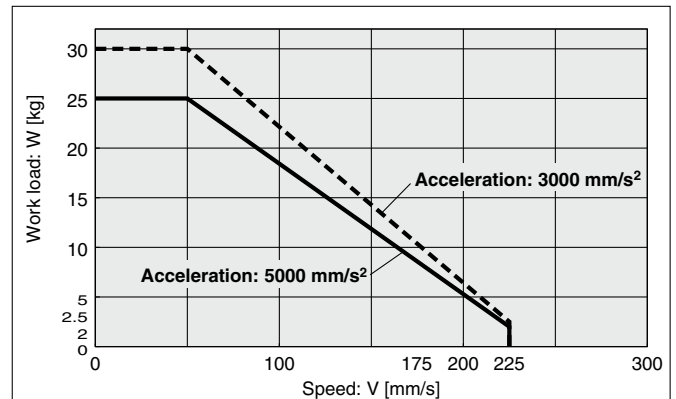

**Operating temperature:** Use products with a duty ratio of 100% or less when the temperature is below 30°C and with a duty ratio of 35% or less when the temperature exceeds 30°C.

Model Selection

LEFS□F Series

LEY□F Series

Auto Switch

JXC5H/6H Series

JXCEH/9H/PH Series

## Speed-Work Load Graph (Guide)

\* The following graphs show the values when the external guide is used together, and the moving force is 100%.

### LEY40 FA

#### Horizontal/Lead 16

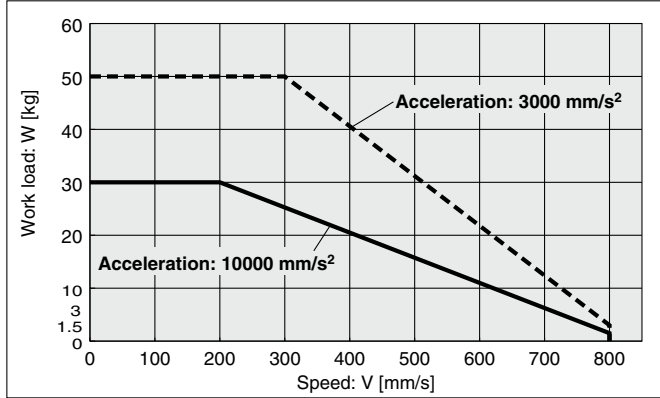

#### Vertical/Lead 16

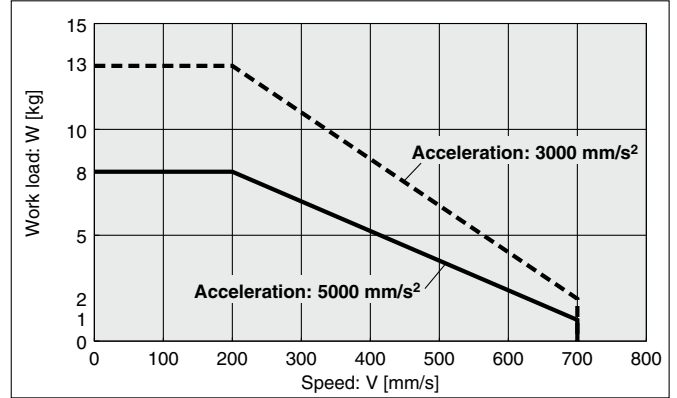

### LEY40 FB

#### Horizontal/Lead 8

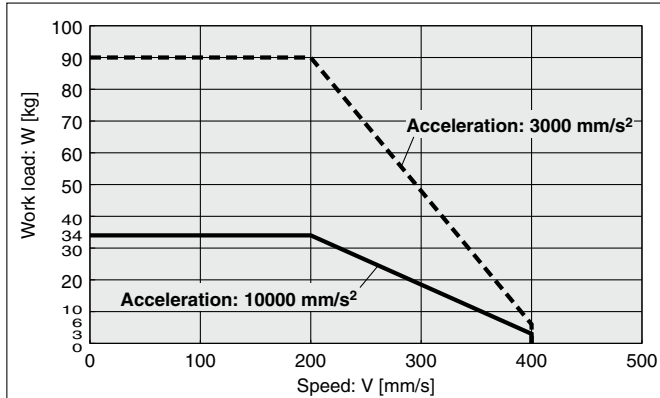

#### Vertical/Lead 8

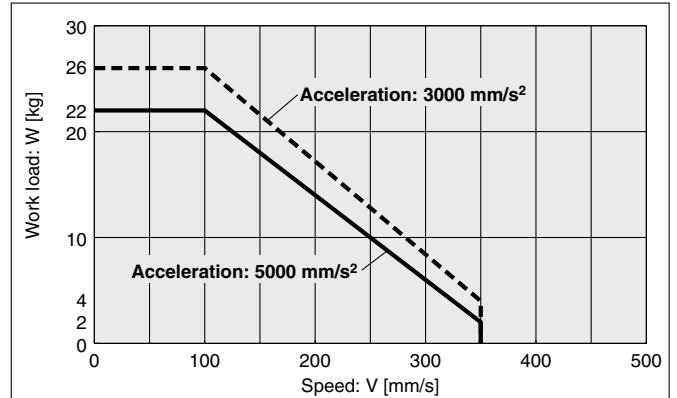

### LEY40 FC

#### Horizontal/Lead 4

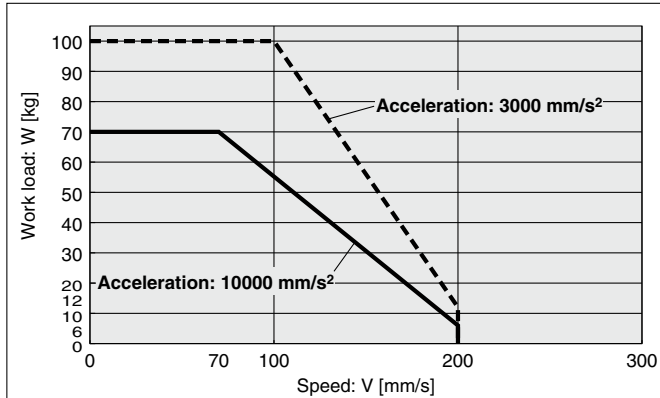

#### Vertical/Lead 4

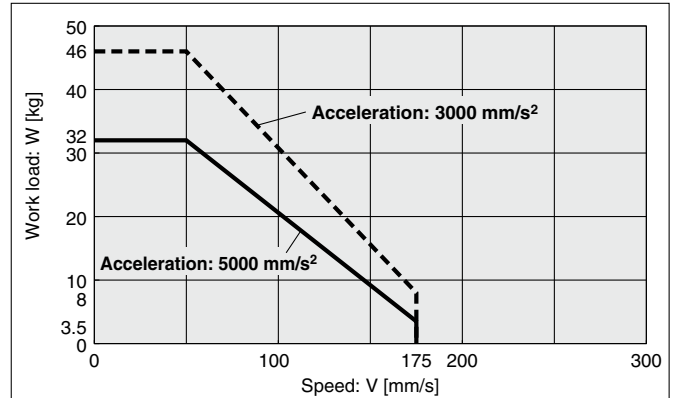

**Operating temperature:** Use products with a duty ratio of 100% or less when the temperature is below 30°C and with a duty ratio of 35% or less when the temperature exceeds 30°C.



## Graph of Allowable Lateral Load on the Rod End (Guide)

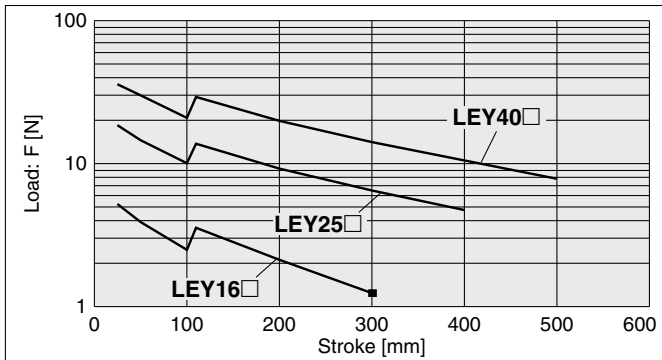

[Stroke] = [Product stroke] + [Distance from the rod end to the center of gravity of the workpiece]

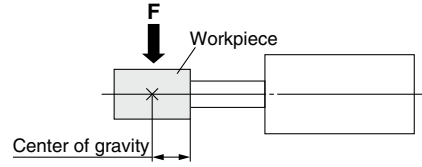

## Rod Displacement: $\delta$ [mm]

Stroke \ Size	30	50	100	150	200	250	300	350	400	450	500
<b>16</b>	±0.4	±0.5	±0.9	±0.8	±1.1	±1.3	±1.5	—	—	—	—
<b>25</b>	±0.3	±0.4	±0.7	±0.7	±0.9	±1.1	±1.3	±1.5	±1.7	—	—
<b>40</b>	±0.3	±0.4	±0.7	±0.6	±0.8	±1.0	±1.1	±1.3	±1.5	±1.7	±1.8

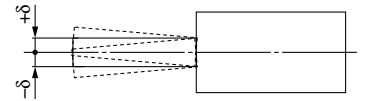

## Non-rotating Accuracy of Rod

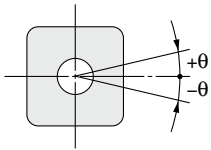

Size	Non-rotating accuracy $\theta$
<b>16</b>	±1.1°
<b>25</b>	±0.8°
<b>40</b>	±0.7°

\* Avoid using the electric actuator in such a way that rotational torque would be applied to the piston rod. Failure to do so may result in the deformation of the non-rotating guide, abnormal auto switch responses, play in the internal guide, or an increase in the sliding resistance.

## Force Conversion Graph (Guide)

### LEY16□F

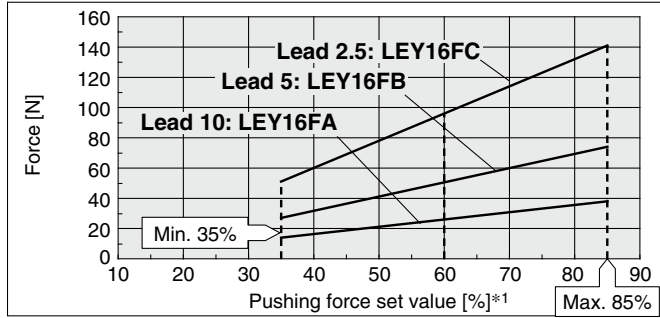

Ambient temperature	Pushing force set value [%]	Duty ratio [%]	Continuous pushing time [min]
25°C or less	85 or less	100	—
	40 or less	100	—
40°C	50	70	12 or less
	70	20	1.3 or less
	85	15	0.8 or less

### LEY25□F

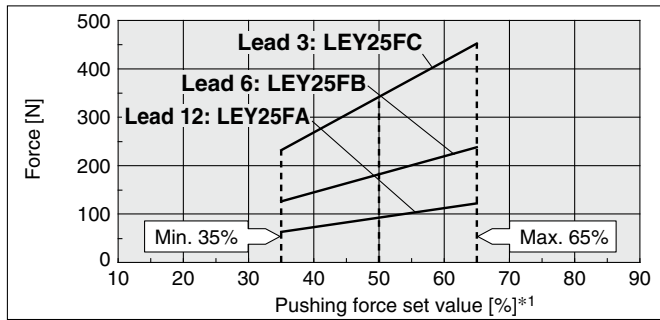

Ambient temperature	Pushing force set value [%]	Duty ratio [%]	Continuous pushing time [min]
40°C or less	65 or less	100	—

### LEY40□F

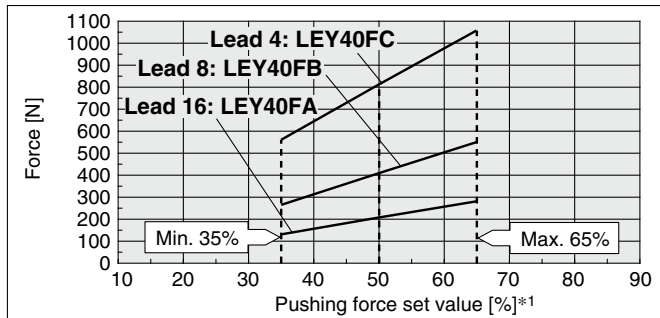

Ambient temperature	Pushing force set value [%]	Duty ratio [%]	Continuous pushing time [min]
40°C or less	65 or less	100	—

\*1 Set values for the controller

### <Limit Values for Pushing Force and Trigger Level in Relation to Pushing Speed>

Model	Lead	Pushing speed [mm/s]	Pushing force (Setting input value)
LEY16□F	A/B/C	21 to 50	60 to 85%
LEY25□F	A/B/C	21 to 35	50 to 65%
LEY40□F	A	24 to 30	50 to 65%
	B/C	21 to 30	

There is a limit to the pushing force in relation to the pushing speed. If the product is operated outside of the range (low pushing force), the completion signal [INP] may be output before the pushing operation has been completed (during the moving operation).

If operating with the pushing speed below the min. speed, please check for operating problems before using the product.

### <Set Values for Vertical Upward Transfer Pushing Operations>

For vertical loads (upward), set the pushing force to the max. value shown below and operate at the work load or less.

Model	LEY16□F			LEY25□F			LEY40□F		
	A	B	C	A	B	C	A	B	C
Work load [kg]	1	1.5	3	2.5	5	10	7	14	28
Pushing force	85%			65%			65%		

**JXCEH/9H/PH Series**

**JXC5H/6H Series**

**Auto Switch**

**LEY□F Series**

**LEFS□F Series**

**Model Selection**

Incremental (Step Motor 24 VDC)

High Performance

Rod Type

LEY□F Series LEY16, 25, 40



How to Order



Motor mounting position:  
Parallel

Motor mounting position:  
In-line

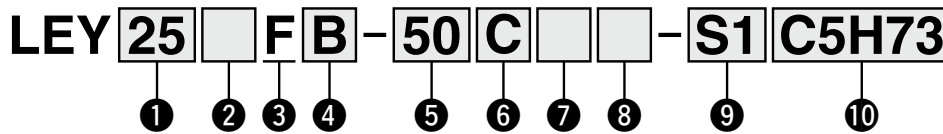

For details on controllers, refer to page 44.

1 Size

16
25
40

2 Motor mounting position/Motor cover direction

Symbol	Motor mounting position	Motor cover direction
Nil	Top side parallel	—
R	Right side parallel	—
L	Left side parallel	—
D	In-line	—*1
D1		Left side*2
D2		Right side*2
D3		Top side*2
D4		Bottom side*2

3 Motor type

Symbol	Type	Compatible controllers
F	High performance (Step motor 24 VDC)	JXC5H JXCEH JXC6H JXC9H JXCPH

4 Lead [mm]

Symbol	LEY16	LEY25	LEY40
A	10	12	16
B	5	6	8
C	2.5	3	4

5 Stroke\*3 [mm]

30	30
to	to
500	500

\* For details, refer to the applicable stroke table below.

6 Motor option\*4

C	With motor cover
W	With lock/motor cover

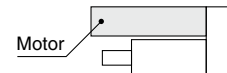

7 Rod end thread

Nil	Rod end female thread
M	Rod end male thread (1 rod end nut is included.)

8 Mounting\*5

Symbol	Type	Motor mounting position	
		Parallel	In-line
Nil	Ends tapped/ Body bottom tapped*6	●	●
L	Foot bracket	●	—
F	Rod flange*6	●*8	●
G	Head flange*6	●*9	—
D	Double clevis*7	●	—

9 Actuator cable type/length

Standard cable [m]		Robotic cable [m]			
Nil	None	R1	1.5	RA	10*10
S1	1.5	R3	3	RB	15*10
S3	3	R5	5	RC	20*10
S5	5	R8	8*10		

Applicable Stroke Table

Size	Stroke [mm]											Manufacturable stroke range
	30	50	100	150	200	250	300	350	400	450	500	
16	●	●	●	●	●	●	●	—	—	—	—	10 to 300
25	●	●	●	●	●	●	●	●	●	—	—	15 to 400
40	●	●	●	●	●	●	●	●	●	●	●	20 to 500

For auto switches, refer to pages 55 to 58.

**10 Controller**

Nil	Without controller
C□H□□	With controller

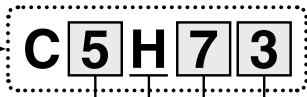

**Interface (Communication protocol/Input/Output)**

5	Parallel I/O (NPN)
6	Parallel I/O (PNP)
E	EtherCAT
9	EtherNet/IP™
P	PROFINET

**Mounting**

7	Screw mounting
8*11	DIN rail

**Number of axes/Special specification**

H	1 axis/High performance type
---	------------------------------

**Communication plug connector, I/O cable\*12**

Symbol	Type	Applicable interface
Nil	Without accessory	—
1	I/O cable (1.5 m)	Parallel input (NPN) Parallel input (PNP)
3	I/O cable (3 m)	
5	I/O cable (5 m)	

- \*1 Sizes 25 and 40 only
- \*2 Size 16 only
- \*3 Please contact SMC for non-standard strokes as they are produced as special orders.
- \*4 When "With lock/motor cover" is selected for the top/right/left side parallel motor types, the motor body will stick out from the end of the body for size 16 with strokes of 50 mm or less and size 40 with strokes of 30 mm or less. Check for interference with workpieces before selecting a model.
- \*5 The mounting bracket is shipped together with the product but does not come assembled.
- \*6 For the horizontal cantilever mounting of the rod flange, head flange, or ends tapped types, use the actuator within the following stroke range.  
 · LEY25: 200 or less · LEY40: 100 or less

- \*7 For the mounting of the double clevis type, use the actuator within the following stroke range.  
 · LEY16: 100 or less · LEY25: 200 or less · LEY40: 200 or less
- \*8 The rod flange type is not available for the LEY16 with strokes of 50 mm or less and LEY40 with strokes of 30 mm or less, and motor option "With lock/motor cover."
- \*9 The head flange type is not available for the LEY40.
- \*10 Produced upon receipt of order
- \*11 The DIN rail is not included. It must be ordered separately.
- \*12 Select "Nil" for anything other than parallel input.  
 Select "Nil," "1," "3," or "5" for parallel input.

**⚠ Caution**

**[CE/UKCA-compliant products]**

EMC compliance was tested by combining the electric actuator LEY series and the controller JXC series.

The EMC depends on the configuration of the customer's control panel and the relationship with other electrical equipment and wiring. Therefore, compliance with the EMC directive cannot be certified for SMC components incorporated into the customer's equipment under actual operating conditions. As a result, it is necessary for the customer to verify compliance with the EMC directive for the machinery and equipment as a whole.

**■ Trademark**

EtherNet/IP® is a registered trademark of ODVA, Inc.  
 EtherCAT® is registered trademark and patented technology, licensed by Beckhoff Automation GmbH, Germany.

**The actuator and controller are sold as a package.**

Confirm that the combination of the controller and actuator is correct.

**<Check the following before use.>**

- \*1 Check the actuator label for the model number.  
 This number should match that of the controller.

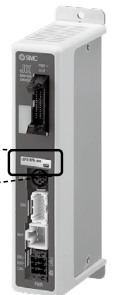
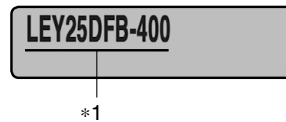

\* Refer to the Operation Manual for using the products.  
 Please download it via our website: <https://www.smcworld.com>

**Compatible Controllers**

Type	Step data input type	EtherCAT direct input type	EtherNet/IP™ direct input type	PROFINET direct input type
<b>Series</b>	<b>JXC5H JXC6H</b>	<b>JXCEH</b>	<b>JXC9H</b>	<b>JXCPH</b>
<b>Features</b>	Parallel I/O	EtherCAT direct input	EtherNet/IP™ direct input	PROFINET direct input
<b>Compatible motor</b>	Step motor 24 VDC	Step motor (Servo/24 VDC)		
<b>Max. number of step data</b>	64 points	64 points		
<b>Power supply voltage</b>	24 VDC	24 VDC		
<b>Reference page</b>	61	68		

## Specifications

Model		LEY16F			LEY25F			LEY40F				
Actuator specifications	Work load [kg] <sup>*1</sup>	Horizontal	(10000 [mm/s <sup>2</sup> ])	4	8	30	13	25	40	30	34	70
			(3000 [mm/s <sup>2</sup> ])	6	18	36	26	40	70	50	90	100
		Vertical	(5000 [mm/s <sup>2</sup> ])	2	4	8	7	14	25	8	22	32
			(3000 [mm/s <sup>2</sup> ])	2	4	8	8	16	30	13	26	46
	Pushing force [N] <sup>*2 *3 *4</sup>		14 to 38	27 to 74	51 to 141	63 to 122	126 to 238	232 to 452	132 to 283	266 to 553	562 to 1058	
	Speed [mm/s] <sup>*4</sup>	Stroke range	Up to 300	15 to 700	8 to 350	4 to 175	18 to 700	9 to 450	5 to 225	24 to 800	12 to 400	6 to 200
			350 to 400	—	—	—	18 to 600	9 to 300	5 to 150	24 to 640	12 to 320	6 to 160
			400 to 500	—	—	—	—	—	—	24 to 640	12 to 320	6 to 160
	Max. acceleration/deceleration [mm/s <sup>2</sup> ]		10000									
	Pushing speed [mm/s] <sup>*5</sup>		50 or less			35 or less			30 or less			
Positioning repeatability [mm]		±0.02										
Lost motion [mm] <sup>*6</sup>		0.1 or less										
Screw lead [mm]		10	5	2.5	12	6	3	16	8	4		
Impact/Vibration resistance [m/s <sup>2</sup> ] <sup>*7</sup>		50/20										
Actuation type		Ball screw + Belt (LEY□F)/Ball screw (LEY□DF)										
Guide type		Sliding bushing (Piston rod)										
Operating temperature range [°C]		5 to 40										
Operating humidity range [%RH]		90 or less (No condensation)										
Enclosure		IP40										
Electric specifications	Motor size		□28			□42			□56.4			
	Motor type		Step motor (Servo/24 VDC)									
	Encoder		Incremental									
	Power supply voltage [V]		24 VDC ±10%									
	Power [W] <sup>*8 *9</sup>		Max. power 102			Max. power 132			Max. power 202			
Lock unit specifications	Type <sup>*10</sup>		Non-magnetizing lock									
	Holding force [N]		20	39	78	78	157	294	127	265	519	
	Power [W] <sup>*9</sup>		2.9			5			5			
	Rated voltage [V]		24 VDC ±10%									

\*1 Horizontal: Please use an external guide (friction coefficient: 0.1 or less). The work load shows the maximum value. The actual work load and transfer speed change according to the condition of the external guide.

For the speed, acceleration, and duty ratio according to the work load, check the "Speed-Work Load Graph" on pages 37 to 39.

Vertical: If the rod orientation is vertical or radial load is applied to the rod, please use an external guide (friction coefficient: 0.1 or less). The work load represents the maximum value. The actual work load and transfer speed change according to the condition of the external guide.

For the speed, acceleration, and duty ratio according to the work load, check the "Speed-Work Load Graph" on pages 37 to 39.

The values shown in ( ) are the max. acceleration/deceleration. Set the acceleration/deceleration speed to 10000 [mm/s<sup>2</sup>] or less for the horizontal direction and 5000 [mm/s<sup>2</sup>] or less for the vertical direction.

\*2 Pushing force accuracy is ±20% (F.S.).

\*3 The pushing force set values for LEY16□F are 35% to 85%, for LEY25□F are 35% to 65%, and for LEY40□F are 35% to 65%.

The pushing force values change according to the duty ratio and pushing speed. Check the "Force Conversion Graph" on page 41.

\*4 The speed and force may change depending on the cable length, load, and mounting conditions. Furthermore, if the cable length exceeds 5 m, then it will decrease by up to 10% for each 5 m. (At 15 m: Reduced by up to 20%)

\*5 The allowable speed for pushing operation. When push conveying a workpiece, operate at the vertical work load or less.

\*6 A reference value for correcting errors in reciprocal operation

\*7 Impact resistance: No malfunction occurred when the actuator was tested with a drop tester in both an axial direction and a perpendicular direction to the lead screw. (The test was performed with the actuator in the initial state.)

Vibration resistance: No malfunction occurred in a test ranging between 45 to 2000 Hz. The test was performed in both an axial direction and a perpendicular direction to the lead screw. (The test was performed with the actuator in the initial state.)

\*8 Indicates the max. power during operation (including the controller). This value can be used for the selection of the power supply.

\*9 For an actuator with lock, add the power for the lock.

\*10 With lock only

## Weight

### Weight: Top/Right/Left Side Parallel Motor Type

Series	LEY16							LEY25								
Stroke [mm]	30	50	100	150	200	250	300	30	50	100	150	200	250	300	350	400
Product weight [kg]	0.75	0.79	0.90	1.04	1.15	1.26	1.37	1.43	1.50	1.67	1.93	2.11	2.28	2.46	2.63	2.81

Series	LEY40										
Stroke [mm]	30	50	100	150	200	250	300	350	400	450	500
Product weight [kg]	2.88	2.99	3.28	3.56	3.96	4.25	4.53	4.82	5.11	5.39	5.68

### Weight: In-line Motor Type

Series	LEY16D							LEY25D								
Stroke [mm]	30	50	100	150	200	250	300	30	50	100	150	200	250	300	350	400
Product weight [kg]	0.72	0.76	0.87	1.01	1.12	1.23	1.34	1.36	1.43	1.60	1.86	2.04	2.21	2.39	2.56	2.74

Series	LEY40D										
Stroke [mm]	30	50	100	150	200	250	300	350	400	450	500
Product weight [kg]	2.80	2.91	3.20	3.48	3.88	4.17	4.45	4.74	5.03	5.31	5.60

### Additional Weight

Size		[kg]		
		16	25	40
Lock/Motor cover		0.16	0.33	0.65
Rod end male thread	Male thread	0.01	0.03	0.03
	Nut	0.01	0.02	0.02
Foot bracket (2 sets including mounting bolt)		0.06	0.08	0.14
Rod flange (including mounting bolt)		0.13	0.17	0.20
Head flange (including mounting bolt)				
Double clevis (including pin, retaining ring, and mounting bolt)		0.08	0.16	0.22

Model Selection

LEFS□F Series

LEY□F Series

Auto Switch

JXC5H/6H Series

JXCEH/9H/PH Series

## Dimensions: Top Side Parallel Motor

### LEY16F

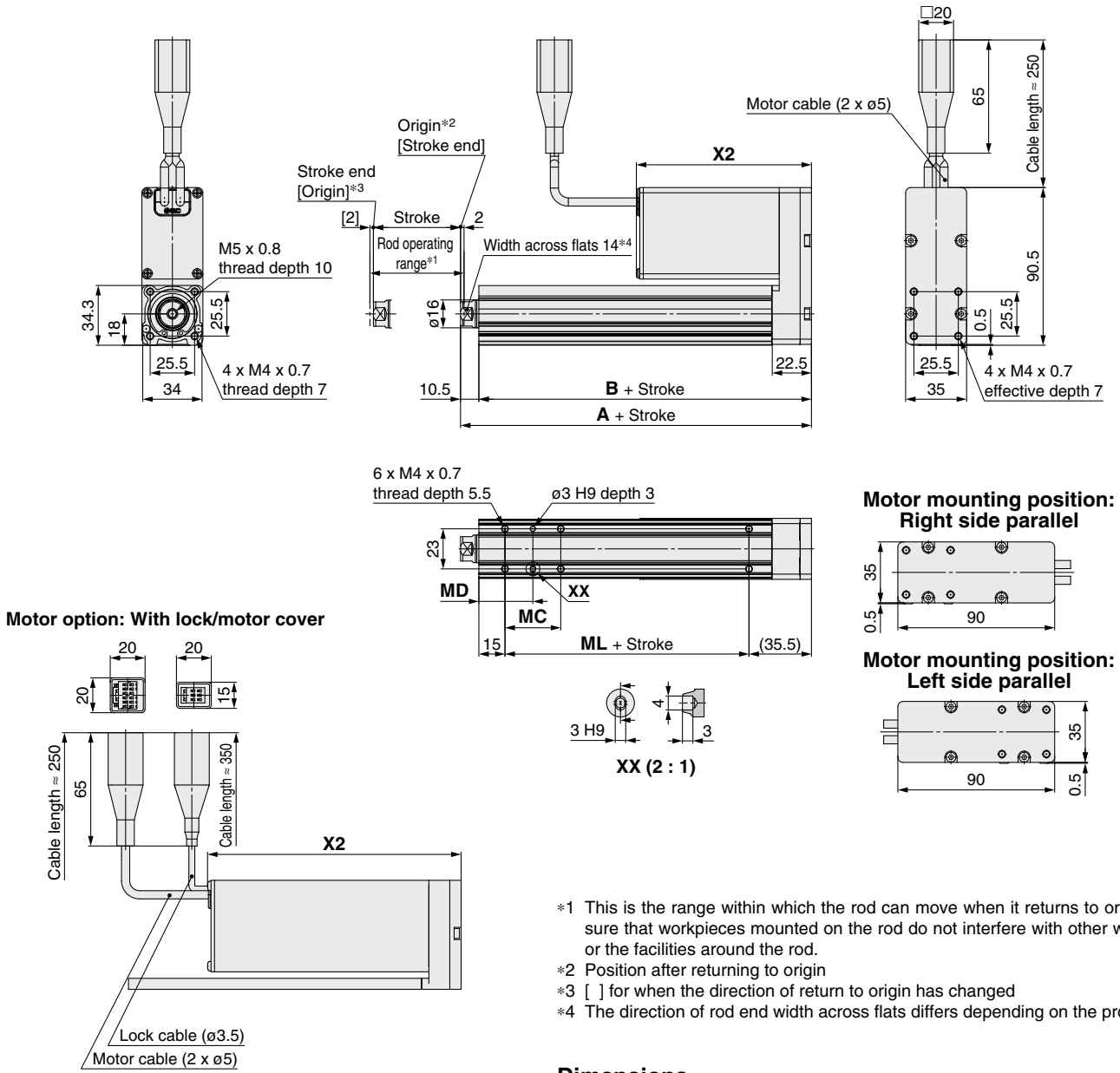

- \*1 This is the range within which the rod can move when it returns to origin. Make sure that workpieces mounted on the rod do not interfere with other workpieces or the facilities around the rod.
- \*2 Position after returning to origin
- \*3 [ ] for when the direction of return to origin has changed
- \*4 The direction of rod end width across flats differs depending on the products.

Stroke range [mm]	Dimensions					X2	
	A	B	MC	MD	ML	With motor cover	With lock/motor cover
30 to 35	101	90.5	17	23.5	40	100.5	145.5
40 to 100			32	31			
105 to 300	121	110.5	62	46	60		



**Dimensions: Top Side Parallel Motor**

**LEY25F**

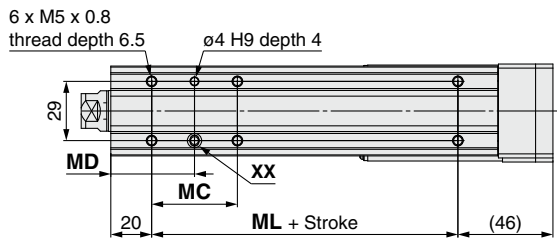
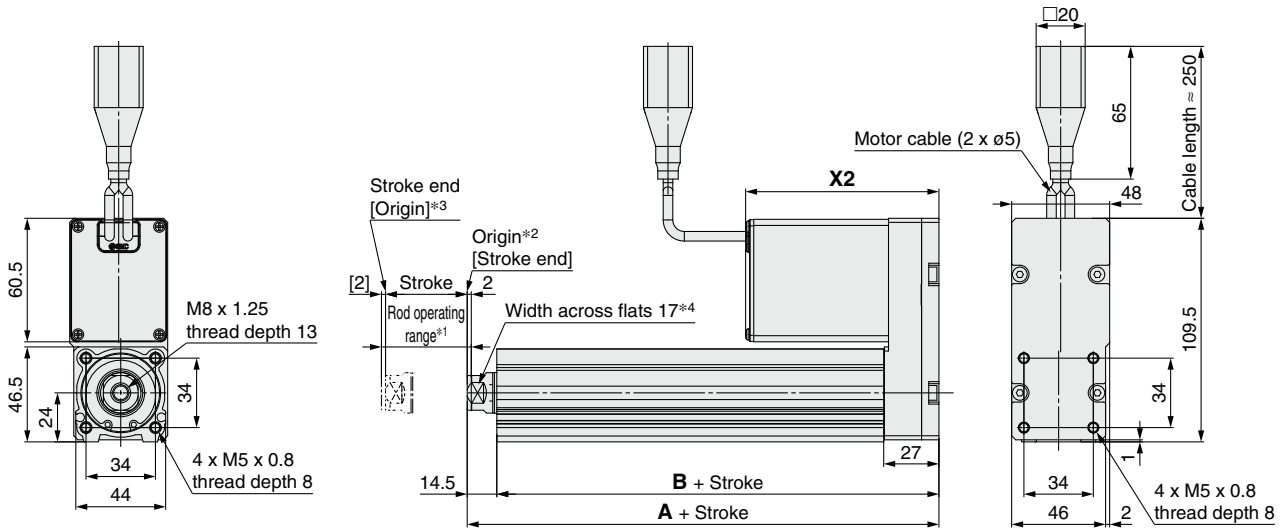

**Motor mounting position: Right side parallel**

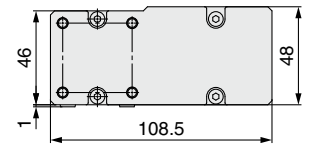

**Motor mounting position: Left side parallel**

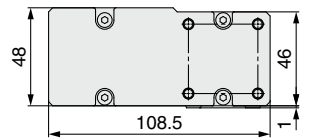

**Motor option: With lock/motor cover**

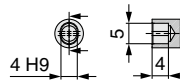
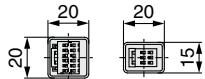

**XX (2 : 1)**

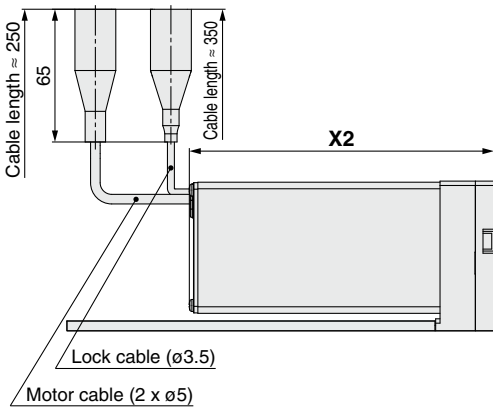

- \*1 This is the range within which the rod can move when it returns to origin. Make sure that workpieces mounted on the rod do not interfere with other workpieces or the facilities around the rod.
- \*2 Position after returning to origin
- \*3 [ ] for when the direction of return to origin has changed
- \*4 The direction of rod end width across flats differs depending on the products.

**Dimensions**

Stroke range [mm]	A	B	MC	MD	ML	X2	
						With motor cover	With lock/motor cover
30 to 35	130.5	116	24	32	50	95	140
40 to 100			42	41			
105 to 120	155.5	141	59	49.5	75	95	140
125 to 200			76	58			
205 to 400							

Model Selection  
**LEYSF Series**  
 LEYF Series  
 Auto Switch  
 JXC5H/6H Series  
 JXCEH/9H/PH Series

## Dimensions: Top Side Parallel Motor

### LEY40F

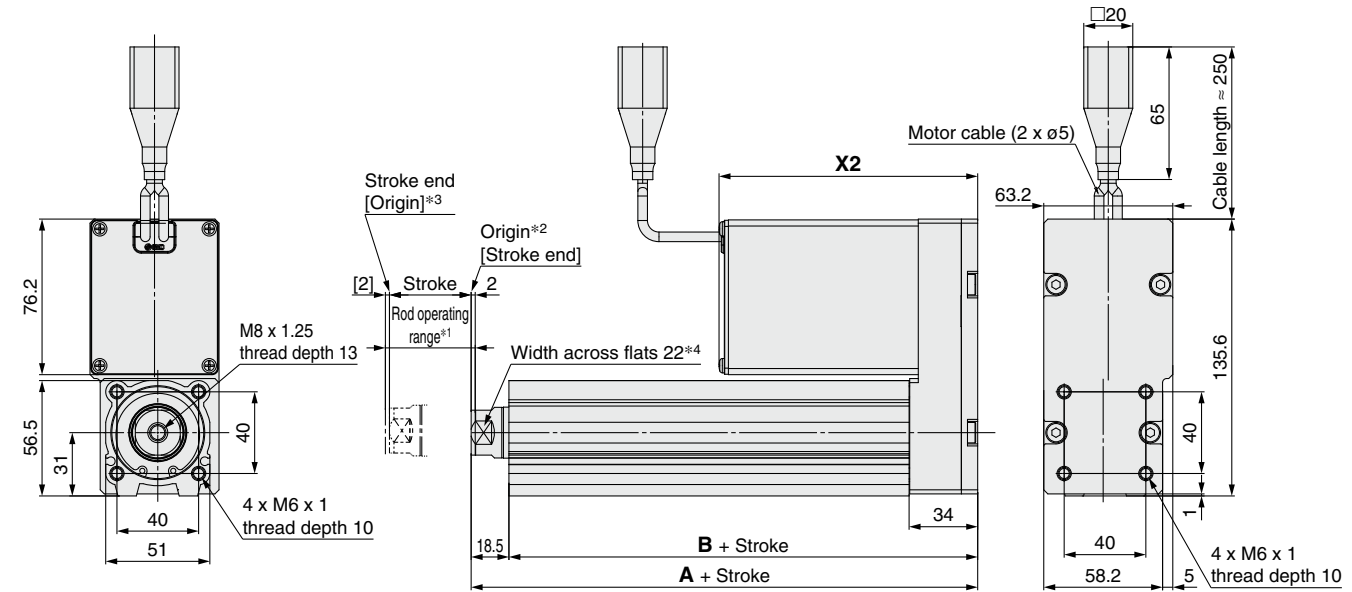

#### Motor option: With lock/motor cover

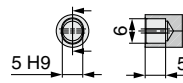
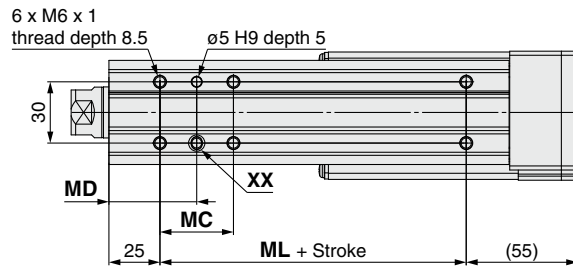
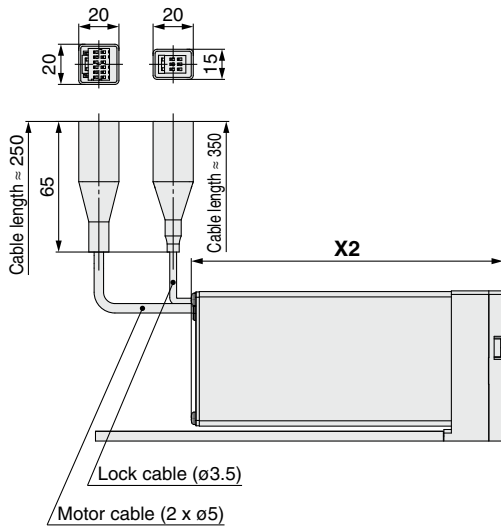

XX (2 : 1)

#### Motor mounting position: Right side parallel

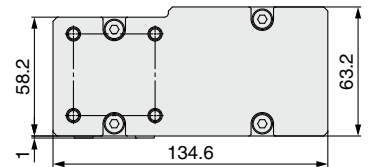

#### Motor mounting position: Left side parallel

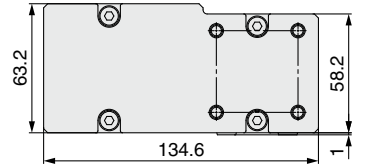

- \*1 This is the range within which the rod can move when it returns to origin. Make sure that workpieces mounted on the rod do not interfere with other workpieces or the facilities around the rod.
- \*2 Position after returning to origin
- \*3 [ ] for when the direction of return to origin has changed
- \*4 The direction of rod end width across flats differs depending on the products.

#### Dimensions

Stroke range [mm]	A	B	MC	MD	ML	X2	
						With motor cover	With lock/motor cover
30 to 35	148.5	130	22	36	50	127	176
40 to 100			36	43			
105 to 120	178.5	160	53	51.5	80		
125 to 200			70	60			
205 to 500							

**Dimensions: In-line Motor**

**LEY16DF**

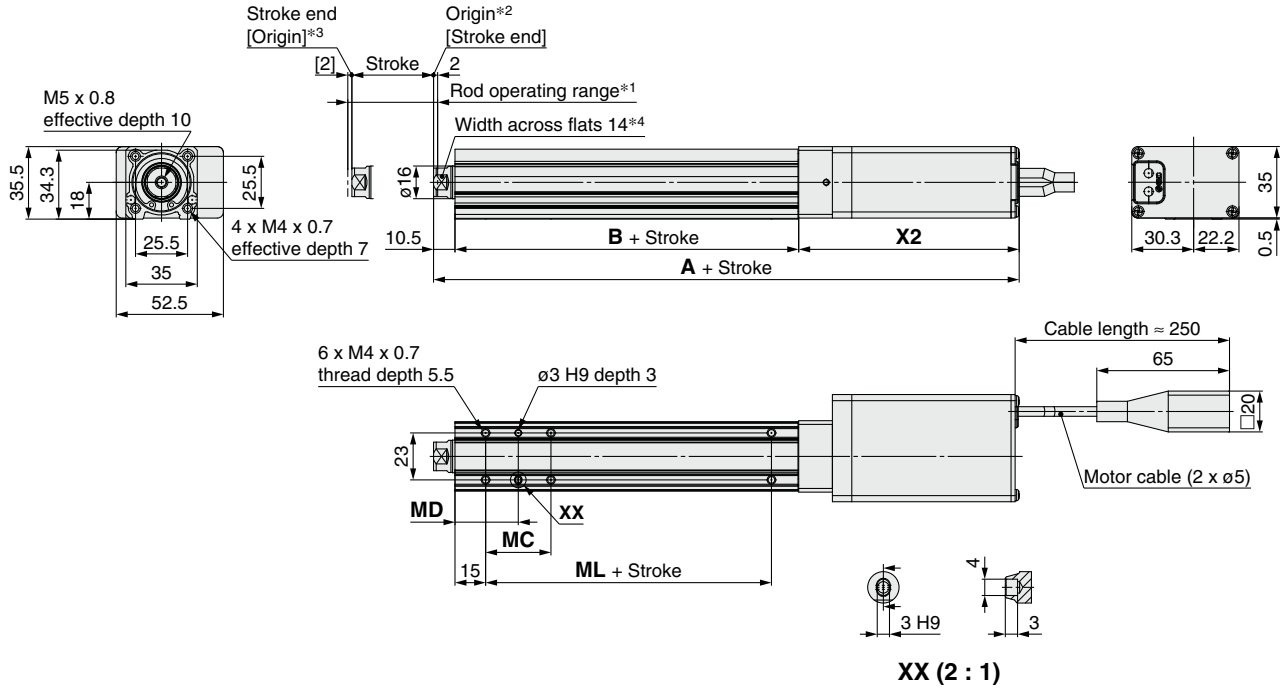

**Motor option: With lock/motor cover**

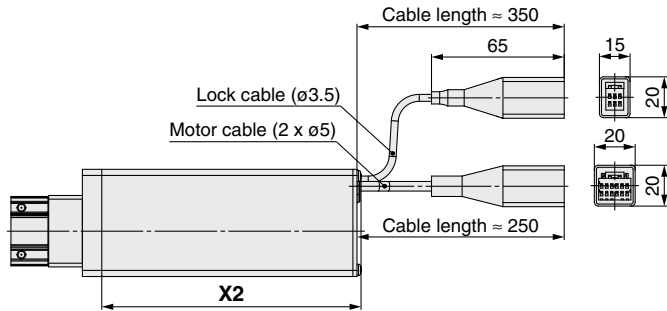

- \*1 This is the range within which the rod can move when it returns to origin. Make sure that workpieces mounted on the rod do not interfere with other workpieces or the facilities around the rod.
- \*2 Position after returning to origin
- \*3 [ ] for when the direction of return to origin has changed
- \*4 The direction of rod end width across flats differs depending on the products.

**Motor Mounting Position/Motor Cover Direction**

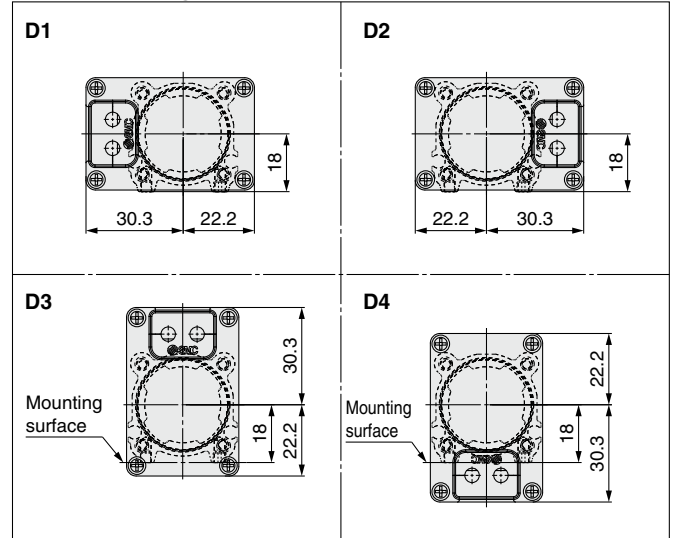

**Dimensions**

[mm]

Stroke range [mm]	A		B	MC	MD	ML	X2	
	With motor cover	With lock/motor cover					With motor cover	With lock/motor cover
30 to 35	186.5	231.5	68	17	23.5	40	108	153
40 to 100				32	31			
105 to 300	206.5	251.5	88	62	46	60		

Model Selection

LEFS□F Series

LEY□F Series

Auto Switch

JXC5H/6H Series

JXCEH/9H/PH Series

## Dimensions: In-line Motor

### LEY25DF

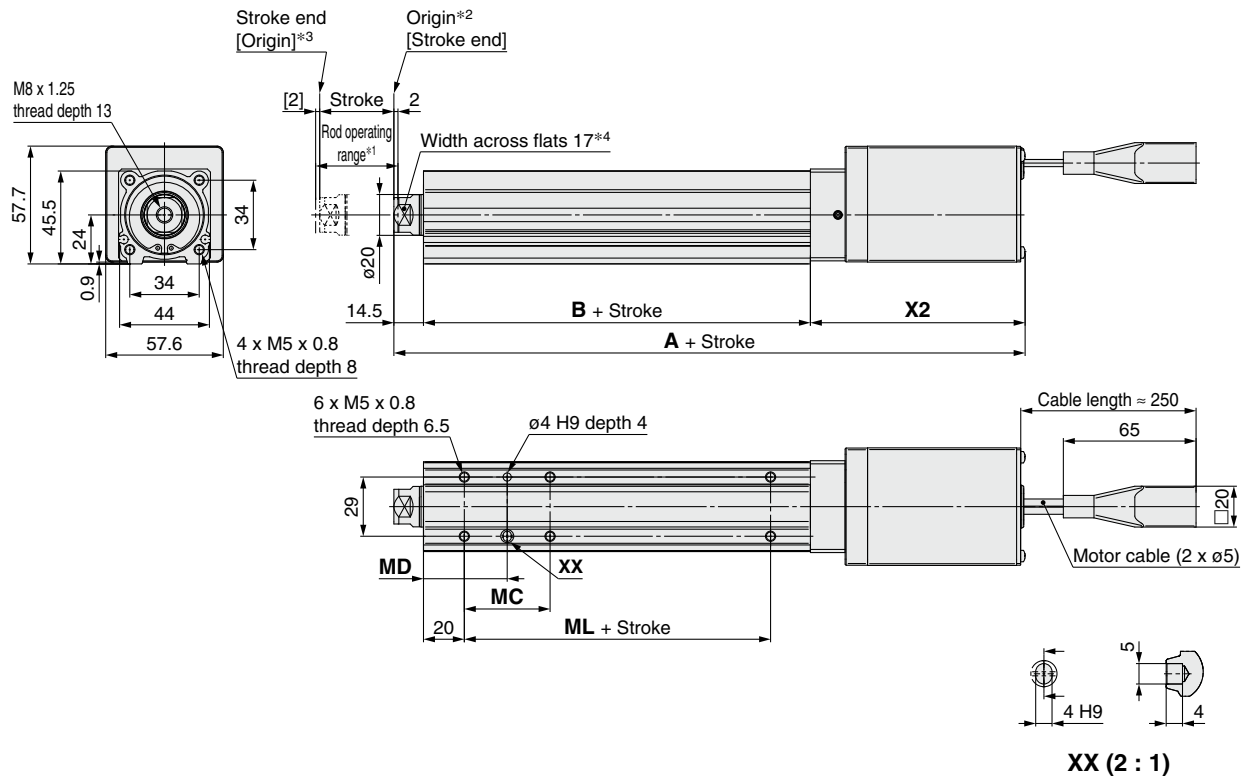

#### Motor option: With lock/motor cover

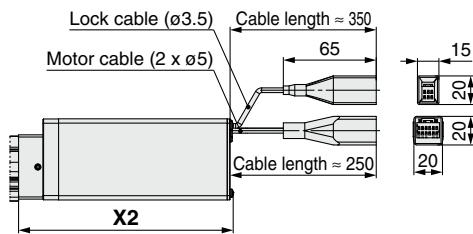

- \*1 This is the range within which the rod can move when it returns to origin. Make sure that workpieces mounted on the rod do not interfere with other workpieces or the facilities around the rod.
- \*2 Position after returning to origin
- \*3 [ ] for when the direction of return to origin has changed
- \*4 The direction of rod end width across flats differs depending on the products.

#### Dimensions

[mm]

Stroke range [mm]	A		B	MC	MD	ML	X2	
	With motor cover	With lock/motor cover					With motor cover	With lock/motor cover
30 to 35	209	254	89.5	24	32	50	105	150
40 to 100				42	41			
105 to 120	234	279	114.5	59	49.5	75	105	150
125 to 200				76	58			
205 to 400								

## Dimensions: In-line Motor

### LEY40DF

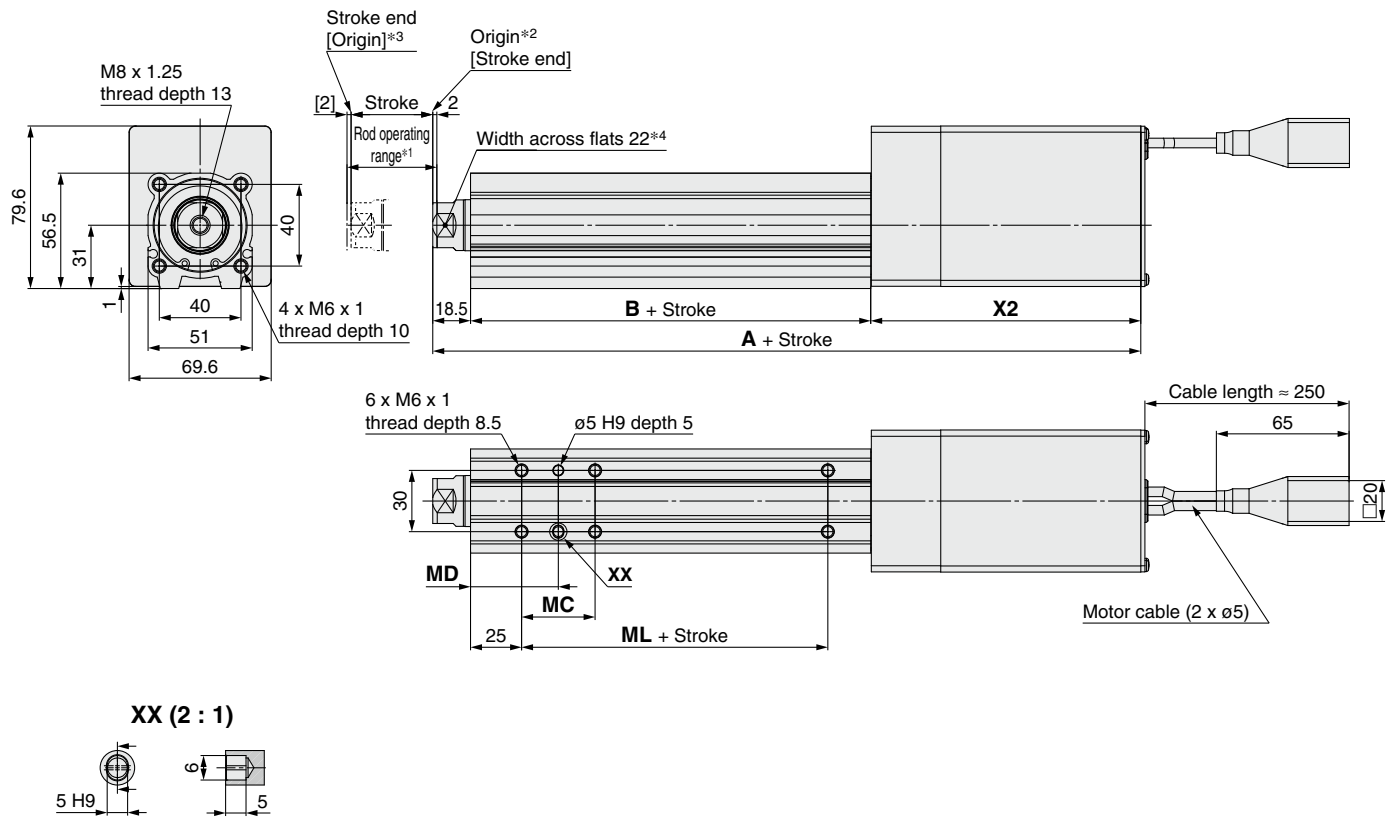

### Motor option: With lock/motor cover

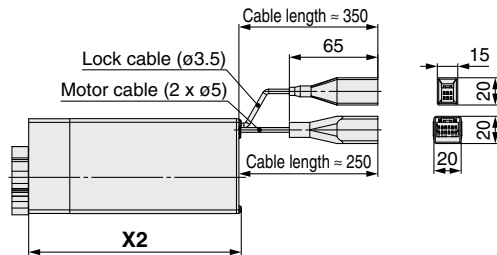

- \*1 This is the range within which the rod can move when it returns to origin. Make sure that workpieces mounted on the rod do not interfere with other workpieces or the facilities around the rod.
- \*2 Position after returning to origin
- \*3 [ ] for when the direction of return to origin has changed
- \*4 The direction of rod end width across flats differs depending on the products.

### Dimensions

[mm]

Stroke range [mm]	A		B	MC	MD	ML	X2	
	With motor cover	With lock/motor cover					With motor cover	With lock/motor cover
30 to 35	250.5	290.5	96	22	36	50	136	176
40 to 100				36	43			
105 to 120	280.5	320.5	126	53	51.5	80	136	176
125 to 200								
205 to 500								

Model Selection

LEFS□F Series

LEY□F Series

Auto Switch

JXC5H/6H Series

JXCEH/9H/PH Series

## Dimensions

End male thread: LEY25□FB-□□M  
 16 A  
 40 C

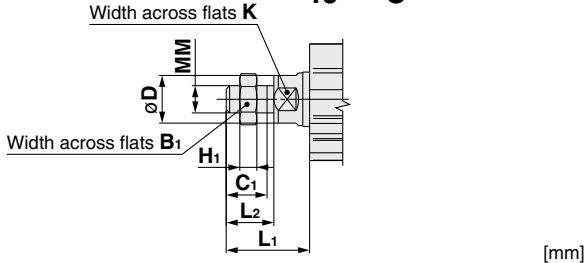

Size	B <sub>1</sub>	C <sub>1</sub>	øD	H <sub>1</sub>	K	L <sub>1</sub>	L <sub>2</sub>	MM
16	13	12	16	5	14	24.5	14	M8 x 1.25
25	22	20.5	20	8	17	38	23.5	M14 x 1.5
40	22	20.5	25	8	22	42	23.5	M14 x 1.5

\* The L<sub>1</sub> measurement is when the unit is in the original position. At this position, 2 mm at the end.

\* Refer to the **Web Catalog** for details on the rod end nut and mounting bracket.  
 \* Refer to the "Handling" precautions in the **Web Catalog** when mounting end brackets such as knuckle joint or workpieces.

Foot bracket: LEY25FB-□□□L  
 16 A  
 40 C

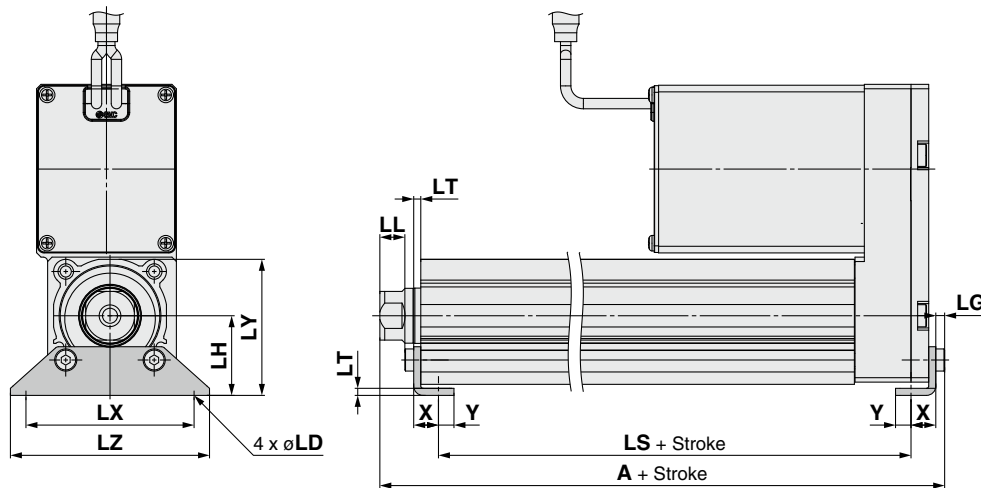

### Outward mounting

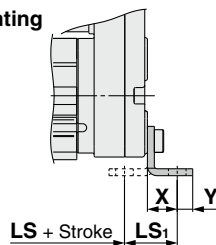

Included parts  
 · Foot bracket  
 · Body mounting bolt

### Foot Bracket

Size	Stroke range [mm]	A	LS	LS <sub>1</sub>	LL	LD	LG	LH	LT	LX	LY	LZ	X	Y
16	30 to 100	106.1	76.7	16.1	5.4	6.6	2.8	24	2.3	48	40.3	62	9.2	5.8
	101 to 300	126.1	96.7											
25	30 to 100	136.6	98.8	19.8	8.4	6.6	3.5	30	2.6	57	51.5	71	11.2	5.8
	101 to 400	161.6	123.8											
40	30 to 100	155.7	114	19.2	11.3	6.6	4	36	3.2	76	61.5	90	11.2	7
	101 to 500	185.7	144											

Material: Carbon steel (Chromating)

\* The A measurement is when the unit is in the original position. At this position, 2 mm at the end.

\* When the motor mounting is the right or left side parallel type, the head side foot bracket should be mounted outward.

**Dimensions**

Rod flange: LEY16□FB-□□□F

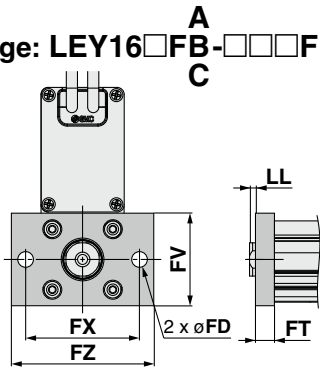

Head flange: LEY16FB-□□□G

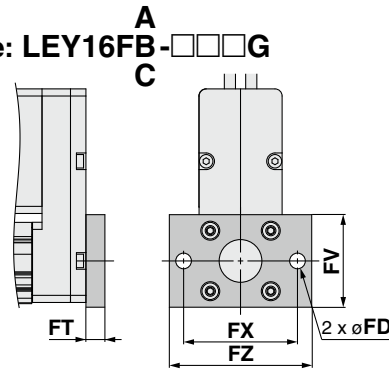

Rod flange: LEY<sup>25</sup>/<sub>40</sub>□FB-□□□F

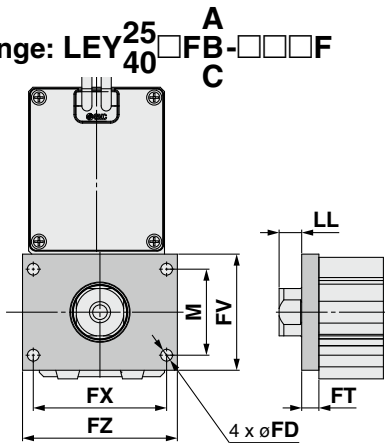

Head flange: LEY<sup>25</sup>/<sub>40</sub>FB-□□□G

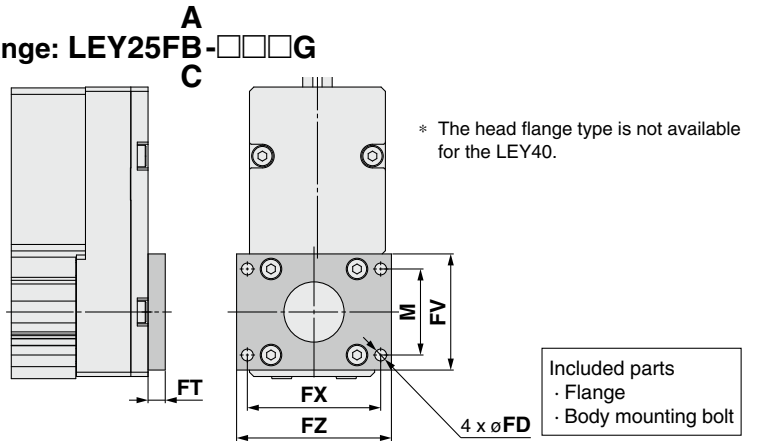

- Included parts  
 · Flange  
 · Body mounting bolt

Double clevis: LEY16FB-□□□D

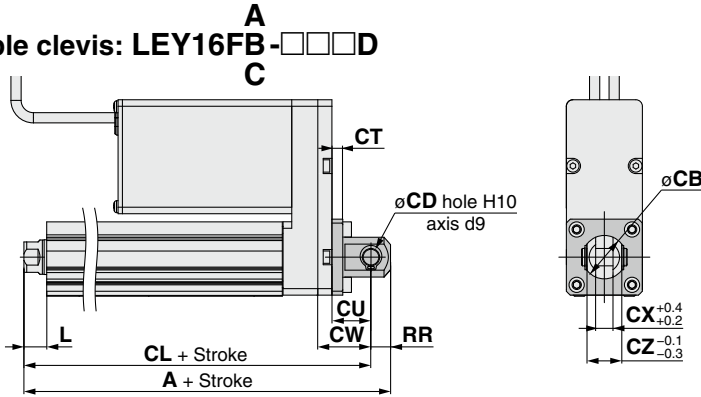

Double clevis: LEY<sup>25</sup>/<sub>40</sub>□FB-□□□D

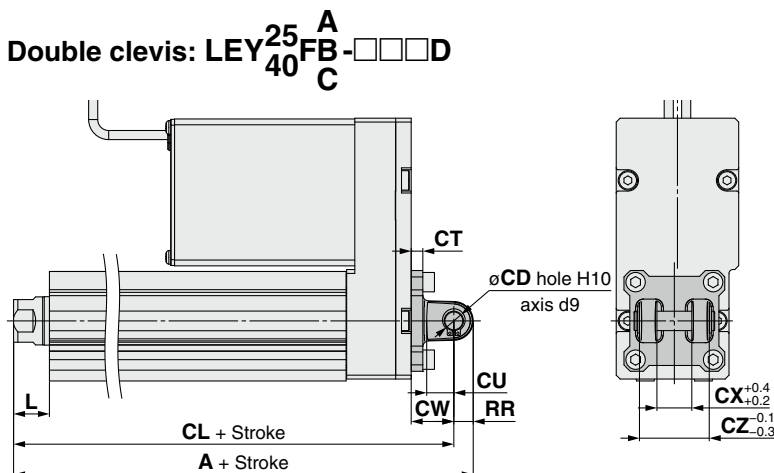

For the models and dimensions of the mounting bracket and simple joint bracket, refer to the **Web Catalog** for the LEY series.

**Rod/Head Flange** [mm]

Size	FD	FT	FV	FX	FZ	LL	M
16	6.6	8	39	48	60	2.5	—
25	5.5	8	48	56	65	6.5	34
40	5.5	8	54	62	72	10.5	40

Material: Carbon steel (Nickel plating)

- Included parts  
 · Double clevis  
 · Body mounting bolt  
 · Clevis pin  
 · Retaining ring

\* Refer to the **Web Catalog** for details on the rod end nut and mounting bracket.

**Double Clevis** [mm]

Size	Stroke range [mm]	A	CL	CB	CD	CT
16	30 to 100	128	119	20	8	5
	101 to 200	160.5	150.5	—	10	5
25	30 to 100	180.5	175.5	—	10	6
	101 to 200	210.5	200.5	—	10	6

Size	Stroke range [mm]	CU	CW	CX	CZ	L	RR
16	30 to 100	12	18	8	16	10.5	9
	101 to 200	14	20	18	36	14.5	10
25	30 to 100	14	22	18	36	18.5	10
	101 to 200	14	22	18	36	18.5	10

Material: Cast iron (Coating)

\* The A and CL measurements are when the unit is in the original position. At this position, 2 mm at the end.

Model Selection  
 LEFS□F Series  
 LEY□F Series

Auto Switch

JXC5H/6H Series

JXCEH/9H/PH Series

# LEY□F Series Auto Switch Mounting

## Auto Switch Proper Mounting Position

Applicable auto switch: D-M9□(V), D-M9□E(V), D-M9□W(V), D-M9□A(V)

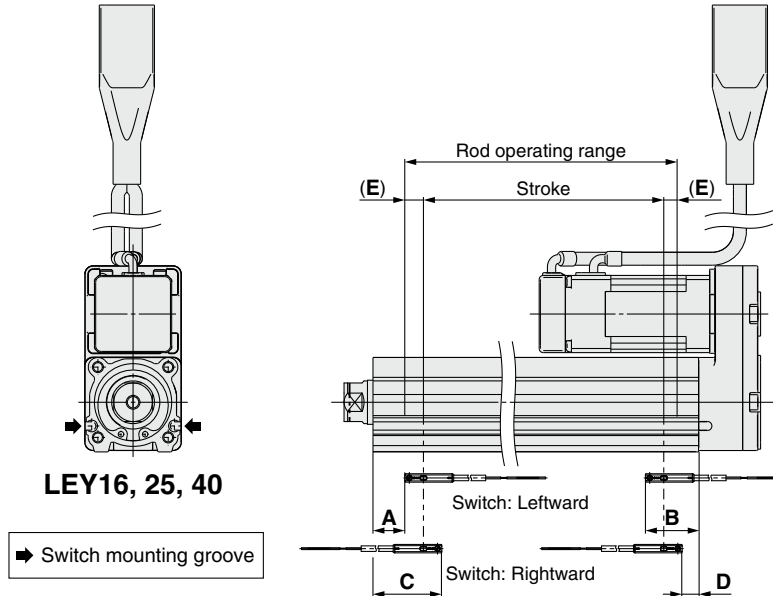

Size	Stroke range	Auto switch position				Return to origin distance	Operating range
		Leftward mounting		Rightward mounting			
		A	B	C	D		
16	30 to 100	21.5	46.5	33.5	34.5	(2)	2.9
	105 to 300	41.5		53.5			
25	30 to 100	27	62.5	39	50.5	(2)	4.2
	105 to 400	52		64			
40	30 to 100	30.5	65.5	42.5	53.5	(2)	4.9
	105 to 500	60.5		72.5			

- \* The values in the table above are to be used as a reference when mounting auto switches for stroke end detection. Adjust the auto switch after confirming the operating conditions in the actual setting.
- \* An auto switch cannot be mounted on the same side as a motor.
- \* For LEYG series models (with a guide), an auto switch cannot be mounted on the guide attachment side (rod side).
- \* Since the operating range is provided as a guideline including hysteresis, it cannot be guaranteed (assuming approx.  $\pm 30\%$  dispersion). It may change substantially depending on the ambient environment.

## Auto Switch Mounting

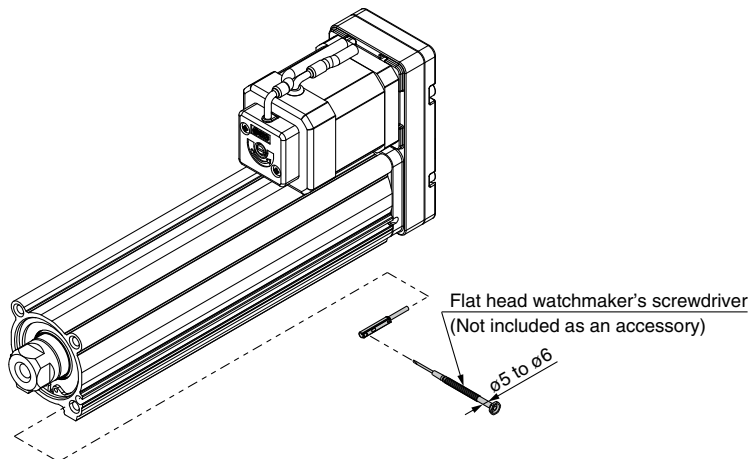

### Tightening Torque for Auto Switch Mounting Screw

Auto switch model	Tightening torque
D-M9□(V) D-M9□E(V) D-M9□W(V)	0.05 to 0.15
D-M9□A(V)	0.05 to 0.10

- \* When tightening the auto switch mounting screw (included with the auto switch), use a watchmaker's screwdriver with a handle diameter of 5 to 6 mm.



# Solid State Auto Switch Direct Mounting Type D-M9N(V)/D-M9P(V)/D-M9B(V)

Refer to the SMC website for details on products that are compliant with international standards.

PLC: Programmable Logic Controller

## Grommet

- 2-wire load current is reduced (2.5 to 40 mA).
- Using flexible cable as standard spec.



## Caution

### Precautions

Fix the auto switch with the existing screw installed on the auto switch body. The auto switch may be damaged if a screw other than the one supplied is used.

## Auto Switch Specifications

D-M9□, D-M9□V (With indicator light)						
Auto switch model	D-M9N	D-M9NV	D-M9P	D-M9PV	D-M9B	D-M9BV
Electrical entry direction	In-line	Perpendicular	In-line	Perpendicular	In-line	Perpendicular
Wiring type	3-wire				2-wire	
Output type	NPN		PNP		—	
Applicable load	IC circuit, Relay, PLC				24 VDC relay, PLC	
Power supply voltage	5, 12, 24 VDC (4.5 to 28 V)				—	
Current consumption	10 mA or less				—	
Load voltage	28 VDC or less		—		24 VDC (10 to 28 VDC)	
Load current	40 mA or less				2.5 to 40 mA	
Internal voltage drop	0.8 V or less at 10 mA (2 V or less at 40 mA)				4 V or less	
Leakage current	100 μA or less at 24 VDC				0.8 mA or less	
Indicator light	Red LED illuminates when turned ON.					
Standard	CE marking, RoHS					

## Oilproof Flexible Heavy-duty Lead Wire Specifications

Auto switch model		D-M9N(V)	D-M9P(V)	D-M9B(V)
Sheath	Outside diameter [mm]	2.6		
Insulator	Number of cores	3 cores (Brown/Blue/Black)		2 cores (Brown/Blue)
	Outside diameter [mm]	0.88		
Conductor	Effective area [mm <sup>2</sup> ]	0.15		
	Strand diameter [mm]	0.05		
Min. bending radius [mm] (Reference values)		17		

- \* Refer to the **Web Catalog** for solid state auto switch common specifications.
- \* Refer to the **Web Catalog** for lead wire lengths.

## Weight

Auto switch model		D-M9N(V)	D-M9P(V)	D-M9B(V)
Lead wire length	0.5 m (Nil)	8	7	7
	1 m (M)	14	13	13
	3 m (L)	41	38	38
	5 m (Z)	68	63	63

## Dimensions

### D-M9□

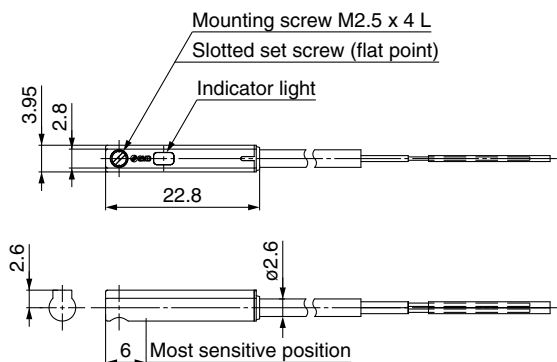

### D-M9□V

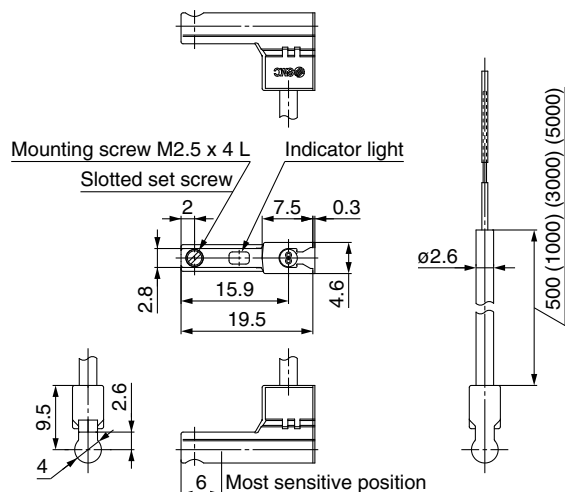

# Normally Closed Solid State Auto Switch Direct Mounting Type

## D-M9NE(V)/D-M9PE(V)/D-M9BE(V)



Refer to the SMC website for details on products that are compliant with international standards.

### Grommet

- Output signal turns on when no magnetic force is detected.
- Can be used for the actuator adopted by the solid state auto switch D-M9 series (excluding special order products)



### Caution

#### Precautions

Fix the auto switch with the existing screw installed on the auto switch body. The auto switch may be damaged if a screw other than the one supplied is used.

### Auto Switch Specifications

PLC: Programmable Logic Controller

D-M9□E, D-M9□EV (With indicator light)						
Auto switch model	D-M9NE	D-M9NEV	D-M9PE	D-M9PEV	D-M9BE	D-M9BEV
Electrical entry direction	In-line	Perpendicular	In-line	Perpendicular	In-line	Perpendicular
Wiring type	3-wire				2-wire	
Output type	NPN		PNP		—	
Applicable load	IC circuit, Relay, PLC				24 VDC relay, PLC	
Power supply voltage	5, 12, 24 VDC (4.5 to 28 V)				—	
Current consumption	10 mA or less				—	
Load voltage	28 VDC or less		—		24 VDC (10 to 28 VDC)	
Load current	40 mA or less				2.5 to 40 mA	
Internal voltage drop	0.8 V or less at 10 mA (2 V or less at 40 mA)				4 V or less	
Leakage current	100 μA or less at 24 VDC				0.8 mA or less	
Indicator light	Red LED illuminates when turned ON.					
Standard	CE marking, RoHS					

### Oilproof Flexible Heavy-duty Lead Wire Specifications

Auto switch model	D-M9NE(V)	D-M9PE(V)	D-M9BE(V)
Sheath	Outside diameter [mm]		
	2.6		
Insulator	Number of cores		2 cores (Brown/Blue)
	Outside diameter [mm]		0.88
Conductor	Effective area [mm <sup>2</sup> ]		0.15
	Strand diameter [mm]		0.05
Min. bending radius [mm] (Reference values)			
17			

- \* Refer to the **Web Catalog** for solid state auto switch common specifications.
- \* Refer to the **Web Catalog** for lead wire lengths.

### Weight

[g]

Auto switch model	D-M9NE(V)	D-M9PE(V)	D-M9BE(V)
Lead wire length	0.5 m (Nil)	8	7
	1 m (M)*1	14	13
	3 m (L)	41	38
	5 m (Z)*1	68	63

\*1 The 1 m and 5 m options are produced upon receipt of order.

### Dimensions

[mm]

#### D-M9□E

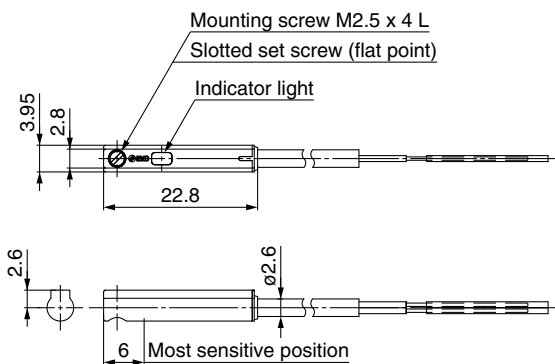

#### D-M9□EV

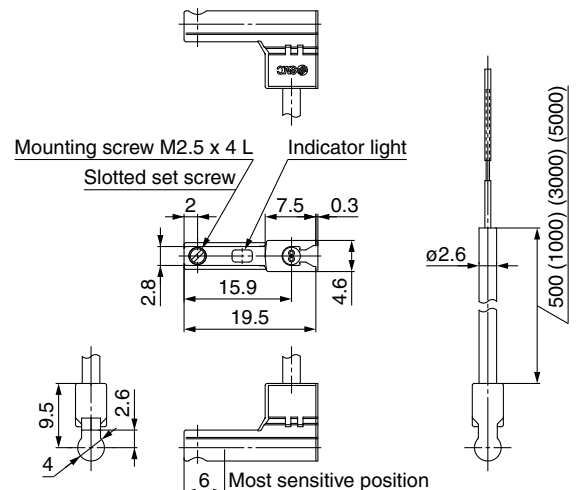

# 2-Color Indicator Solid State Auto Switch Direct Mounting Type

## D-M9NW(V)/D-M9PW(V)/D-M9BW(V)



Refer to the SMC website for details on products that are compliant with international standards.

### Grommet

- 2-wire load current is reduced (2.5 to 40 mA).
- Using flexible cable as standard spec.
- The proper operating range can be determined by the color of the light. (Red → Green ← Red)



### Caution

**Precautions**  
Fix the auto switch with the existing screw installed on the auto switch body. The auto switch may be damaged if a screw other than the one supplied is used.

### Auto Switch Specifications

PLC: Programmable Logic Controller

D-M9□W, D-M9□WV (With indicator light)						
Auto switch model	D-M9NW	D-M9NWV	D-M9PW	D-M9PWV	D-M9BW	D-M9BWV
Electrical entry direction	In-line	Perpendicular	In-line	Perpendicular	In-line	Perpendicular
Wiring type	3-wire				2-wire	
Output type	NPN		PNP		—	
Applicable load	IC circuit, Relay, PLC				24 VDC relay, PLC	
Power supply voltage	5, 12, 24 VDC (4.5 to 28 V)				—	
Current consumption	10 mA or less				—	
Load voltage	28 VDC or less		—		24 VDC (10 to 28 VDC)	
Load current	40 mA or less				2.5 to 40 mA	
Internal voltage drop	0.8 V or less at 10 mA (2 V or less at 40 mA)				4 V or less	
Leakage current	100 μA or less at 24 VDC				0.8 mA or less	
Indicator light	Operating range ..... Red LED illuminates. Proper operating range ..... Green LED illuminates.					
Standard	CE marking, RoHS					

### Oilproof Flexible Heavy-duty Lead Wire Specifications

Auto switch model		D-M9NW(V)	D-M9PW(V)	D-M9BW(V)
Sheath	Outside diameter [mm]	2.6		
Insulator	Number of cores	3 cores (Brown/Blue/Black)		2 cores (Brown/Blue)
	Outside diameter [mm]	0.88		
Conductor	Effective area [mm <sup>2</sup> ]	0.15		
	Strand diameter [mm]	0.05		
Min. bending radius [mm] (Reference values)		17		

- \* Refer to the **Web Catalog** for solid state auto switch common specifications.
- \* Refer to the **Web Catalog** for lead wire lengths.

### Weight

[g]

Auto switch model		D-M9NW(V)	D-M9PW(V)	D-M9BW(V)
Lead wire length	0.5 m (Nil)	8	7	7
	1 m (M)	14	13	13
	3 m (L)	41	38	38
	5 m (Z)	68	63	63

### Dimensions

[mm]

#### D-M9□W

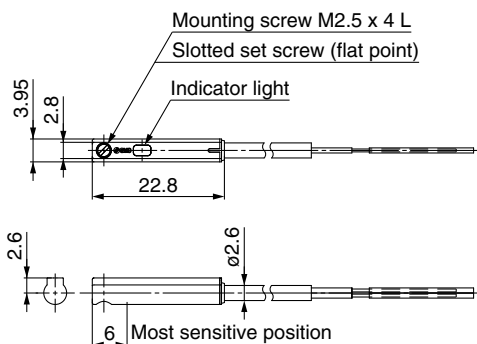

#### D-M9□WV

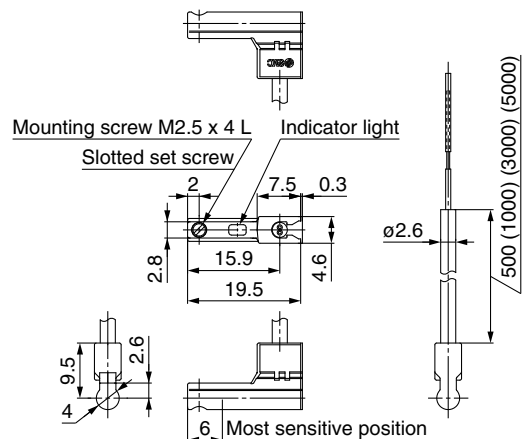



# Controllers

## JXC□ Series



Step Data Input Type ..... p. 61

### High Performance

Incremental (Step Motor 24 VDC)

JXC5H/6H Series



EtherCAT/EtherNet/IP™/PROFINET Direct Input Type ..... p. 68

### High Performance

Incremental (Step Motor 24 VDC)

JXCEH/9H/PH Series

EtherCAT®

EtherNet/IP®

PROFINET®



Precautions Relating to Differences in Controller Versions p. 74

Model Selection

LEFS□F Series

LEY□F Series

Auto Switch

JXC5H/6H Series

JXCEH/9H/PH Series

# High Performance Controller (Step Data Input Type)

## JXC5H/6H Series



For details, refer to page 75.



### How to Order

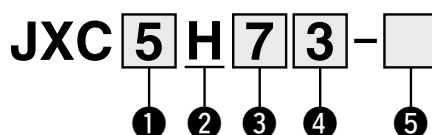

#### 1 Controller type

5	Parallel I/O (NPN) type
6	Parallel I/O (PNP) type

#### 2 Specification

H	1 axis/High performance type
---	------------------------------

#### 3 Mounting

7	Screw mounting
8	DIN rail

#### 4 I/O cable length

Nil	None
1	1.5 m
3	3 m
5	5 m

#### 5 Actuator part number

Without cable specifications and actuator options Example: Enter "LEFS25FA-100" for the LEFS25FA-100B-R1□.	
BC	Blank controller*1

\*1 Requires dedicated software (JXC-BCW)

### The controller is sold as single unit after the compatible actuator is set.

Connect to an actuator (LEFS□□F) designated for a high performance controller. Confirm that the combination of the controller and actuator is correct.

#### <Check the following before use.>

- ① Check the actuator label for the model number. This number should match that of the controller.
- ② Check that the Parallel I/O configuration matches (NPN or PNP).

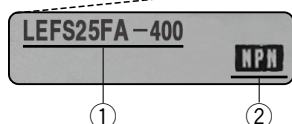

\* Refer to the operation manual for using the products. Please download it via our website: <https://www.smcworld.com>

### Specifications

Model	JXC5H JXC6H
Compatible motor	Step motor (Servo/24 VDC)
Power supply	Power supply voltage: 24 VDC ±10%
Current consumption (Controller)	100 mA or less
Compatible encoder	Incremental
Parallel input	11 inputs (Photo-coupler isolation)
Parallel output	13 outputs (Photo-coupler isolation)
Serial communication	RS485 (Only for the LEC-T1 and JXC-W2)
Memory	EEPROM
LED indicator	PWR, ALM
Cable length [m]	Actuator cable: 20 or less
Cooling system	Natural air cooling
Operating temperature range [°C]	0 to 40
Operating humidity range [%RH]	90 or less (No condensation)
Enclosure	IP30 (Excludes the connector)
Insulation resistance [MΩ]	Between all external terminals and the case: 50 (500 VDC)
Weight [g]	180 (Screw mounting), 200 (DIN rail mounting)

### Precautions for blank controllers (JXC□1□□-BC)

A blank controller is a controller to which the customer can write the data of the actuator it is to be combined and used with. For data writing, use the controller setting software ACT Controller 2 or the dedicated software JXC-BCW.

- Both ACT Controller 2 and JXC-BCW can be downloaded from the SMC website.
- To use this software, order the communication cable for controller setting (JXC-W2A-C) and the USB cable (LEC-W2-U) separately.

#### Hardware Requirements

OS	Windows®10 (64 bit)	Windows®7 Windows®8
	Windows®11	Windows®10
Software	ACT Controller 2 (With JXC-BCW function)	JXC-BCW

\* Windows®7, Windows®8, Windows®10, and Windows®11 are registered trademarks of Microsoft Corporation in the United States.

**SMC website**  
<https://www.smcworld.com>

### ⚠ Caution

#### [CE/UKCA-compliant products]

EMC compliance was tested by combining the electric actuator LE series and the JXC5H/6H series. The EMC depends on the configuration of the customer's control panel and the relationship with other electrical equipment and wiring. Therefore, compliance with the EMC directive cannot be certified for SMC components incorporated into the customer's equipment under actual operating conditions. As a result, it is necessary for the customer to verify compliance with the EMC directive for the machinery and equipment as a whole.

## How to Mount

### a) Screw mounting (JXC□H7□) (Installation with two M4 screws)

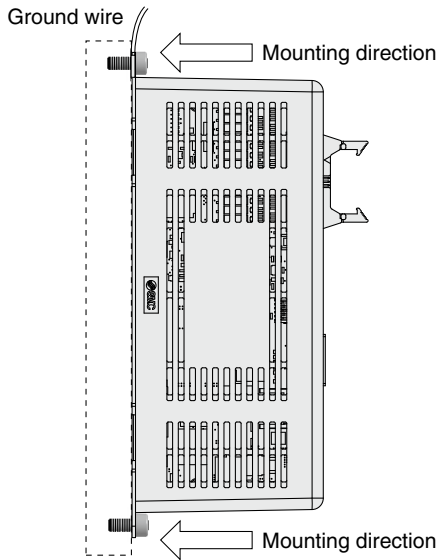

### b) DIN rail mounting (JXC□H8□) (Installation with the DIN rail)

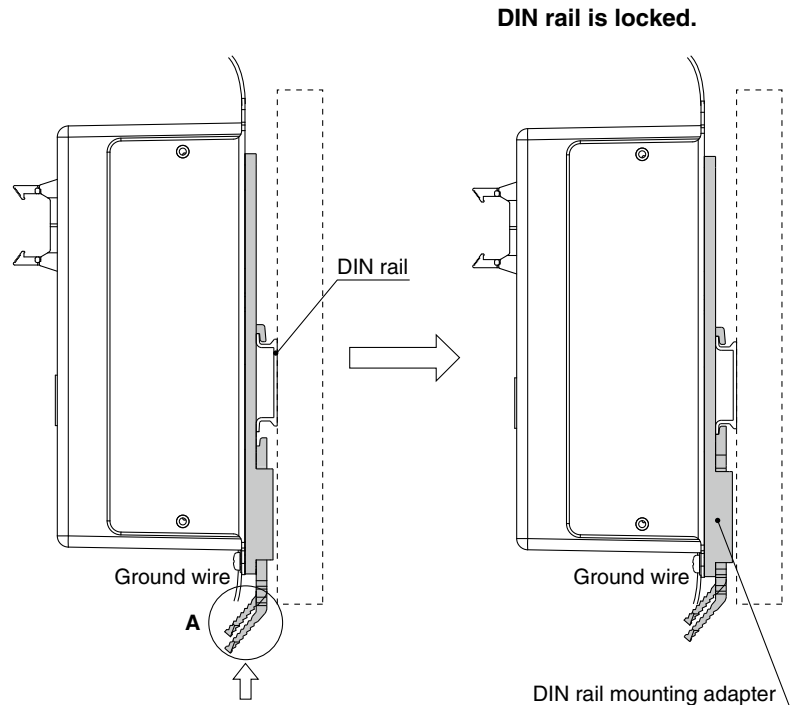

Hook the controller on the DIN rail and press the lever of section A in the arrow direction to lock it.

\* When size 25 or more of the LE series are used, the space between the controllers should be 10 mm or more.

### DIN rail AXT100-DR-□

\* For □, enter a number from the No. line in the table below.  
Refer to the dimension drawings on page 63 for the mounting dimensions.

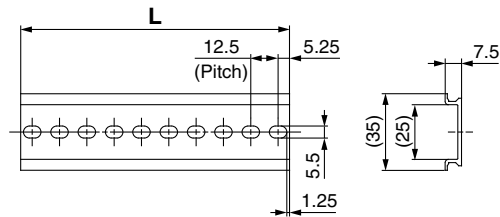

#### L Dimensions [mm]

No.	1	2	3	4	5	6	7	8	9	10	11	12	13	14	15	16	17	18	19	20
L	23	35.5	48	60.5	73	85.5	98	110.5	123	135.5	148	160.5	173	185.5	198	210.5	223	235.5	248	260.5
No.	21	22	23	24	25	26	27	28	29	30	31	32	33	34	35	36	37	38	39	40
L	273	285.5	298	310.5	323	335.5	348	360.5	373	385.5	398	410.5	423	435.5	448	460.5	473	485.5	498	510.5

### DIN rail mounting adapter LEC-3-D0 (with 2 mounting screws)

This should be used when the DIN rail mounting adapter is mounted onto a screw mounting type controller afterward.

Model Selection

LEFS□F Series

LEY□F Series

Auto Switch

JXC5H/6H Series

JXCEH/9H/PH Series

# JXC5H/6H Series

## Dimensions

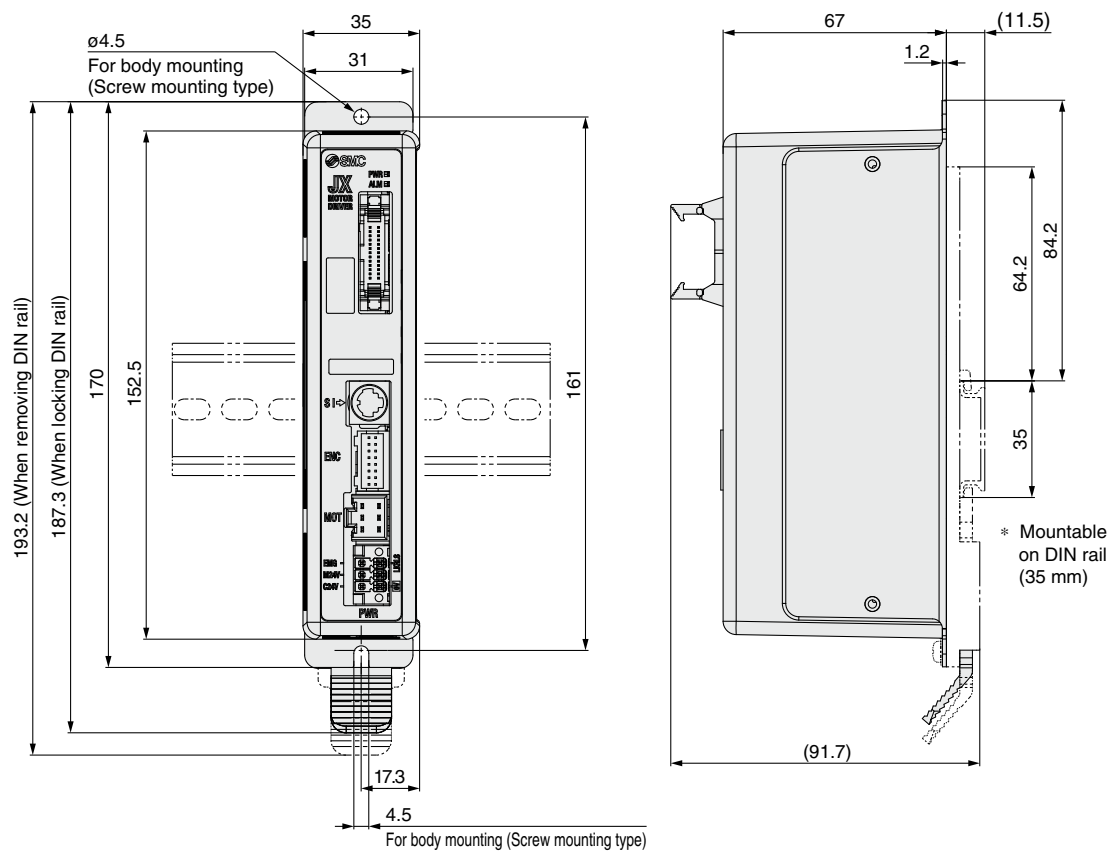



## Wiring Example

### Parallel I/O Connector

- \* When you connect a PLC to the parallel I/O connector, use the I/O cable (LEC-CN5-□).
- \* The wiring changes depending on the type of parallel I/O (NPN or PNP).

### Wiring diagram JXC5H□□ (NPN)

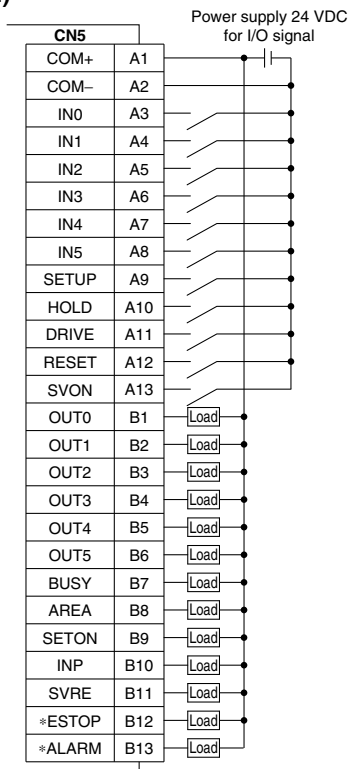

### JXC6H□□ (PNP)

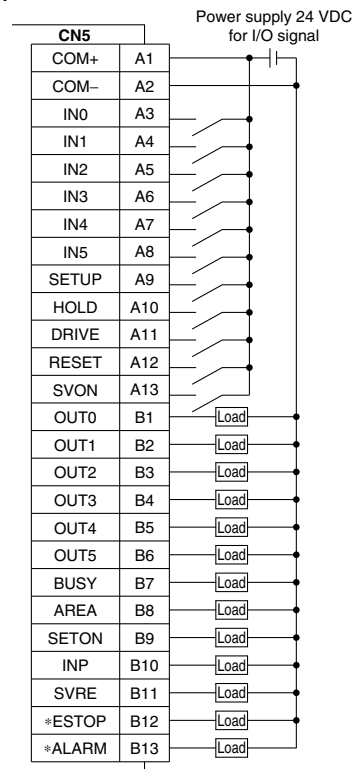

### Input Signal

Name	Details
COM+	Connects the power supply 24 V for input/output signal
COM-	Connects the power supply 0 V for input/output signal
IN0 to IN5	Step data specified bit no. (Input is instructed by combining IN0 to 5.)
SETUP	Instruction to return to origin
HOLD	Temporarily stops operation
DRIVE	Instruction to drive
RESET	Resets alarm and interrupts operation
SVON	Servo ON instruction

### Output Signal

Name	Details
OUT0 to OUT5	Outputs the step data no. during operation
BUSY	Outputs when the actuator is moving
AREA	Outputs within the step data area output setting range
SETON	Outputs when returning to origin
INP	Outputs when target position or target force is reached*2 (Turns on when the positioning or pushing is completed.)
SVRE	Outputs when servo is on
*ESTOP*1	OFF when EMG stop is instructed
*ALARM*1	OFF when alarm is generated

\*1 Signal of negative-logic circuit (N.C.)

\*2 Check the catalog and operation manual of each actuator model which is capable of performing pushing operations.

The "Specifications" table for models which are capable of performing pushing operations includes an item for the pushing force.

Model Selection

LEFS□F Series

LEY□F Series

Auto Switch

JXC5H/6H Series

JXCEH/9H/PH Series

## Step Data Setting

### 1. Step data setting for positioning

In this setting, the actuator moves toward and stops at the target position.

The following diagram shows the setting items and operation.

The setting items and set values for this operation are stated below.

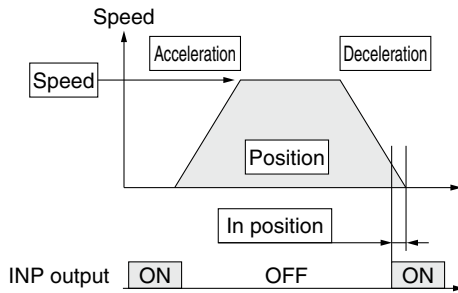

◎ : Need to be set.  
○ : Need to be adjusted as required.  
— : Setting is not required.

#### Step Data (Positioning)

Necessity	Item	Details
◎	Movement MOD	When the absolute position is required, set Absolute. When the relative position is required, set Relative.
◎	Speed	Transfer speed to the target position
◎	Position	Target position
○	Acceleration	Parameter which defines how rapidly the actuator reaches the speed set. The higher the set value, the faster it reaches the speed set.
○	Deceleration	Parameter which defines how rapidly the actuator comes to stop. The higher the set value, the quicker it stops.
◎	Pushing force*1	Set 0. (If values 1 to 100 are set, the operation will be changed to the pushing operation.)
—	Trigger LV	Setting is not required.
—	Pushing speed	Setting is not required.
○	Moving force	Max. torque during the positioning operation (No specific change is required.)
○	Area 1, Area 2	Condition that turns on the AREA output signal.
○	In position	Condition that turns on the INP output signal. When the actuator enters the range of [in position], the INP output signal turns on. (It is unnecessary to change this from the initial value.) When it is necessary to output the arrival signal before the operation is completed, make the value larger.

\*1 Check the catalog and operation manual of each actuator model which is capable of performing pushing operations.

The "Specifications" table for models which are capable of performing pushing operations includes an item for the pushing force.

### 2. Step data setting for pushing\*2

The actuator moves toward the pushing start position, and when it reaches that position, it starts pushing with the set force or less.

The following diagram shows the setting items and operation.

The setting items and set values for this operation are stated below.

\*2 Check the catalog and operation manual of each actuator model which is capable of performing pushing operations.

The "Specifications" table for models which are capable of performing pushing operations includes an item for the pushing force.

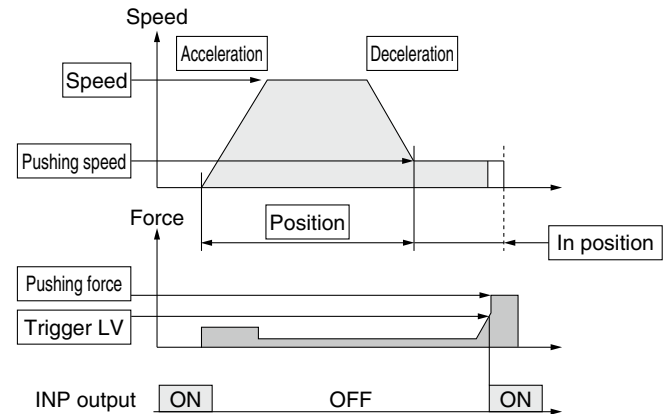

◎ : Need to be set.  
○ : Need to be adjusted as required.

#### Step Data (Pushing)

Necessity	Item	Details
◎	Movement MOD	When the absolute position is required, set Absolute. When the relative position is required, set Relative.
◎	Speed	Transfer speed to the pushing start position
◎	Position	Pushing start position
○	Acceleration	Parameter which defines how rapidly the actuator reaches the speed set. The higher the set value, the faster it reaches the speed set.
○	Deceleration	Parameter which defines how rapidly the actuator comes to stop. The higher the set value, the quicker it stops.
◎	Pushing force*3	Pushing force ratio is defined. The setting range differs depending on the electric actuator type. Refer to the operation manual for the electric actuator.
◎	Trigger LV	Condition that turns on the INP output signal. The INP output signal turns on when the generated force exceeds the value. Trigger level should be the pushing force or less.
○	Pushing speed*3	Pushing speed during pushing. When the speed is set fast, the electric actuator and workpieces might be damaged due to the impact when they hit the end, so this set value should be smaller. Refer to the operation manual for the electric actuator.
○	Moving force	Max. torque during the positioning operation (No specific change is required.)
○	Area 1, Area 2	Condition that turns on the AREA output signal.
◎	In position	Transfer distance during pushing. If the transferred distance exceeds the setting, it stops even if it is not pushing. If the transfer distance is exceeded, the INP output signal will not turn on.

\*3 Check the catalog and operation manual of each actuator model which is capable of performing pushing operations.

The "Specifications" table for models which are capable of performing pushing operations includes an item for the pushing force.

## Signal Timing

### Return to Origin

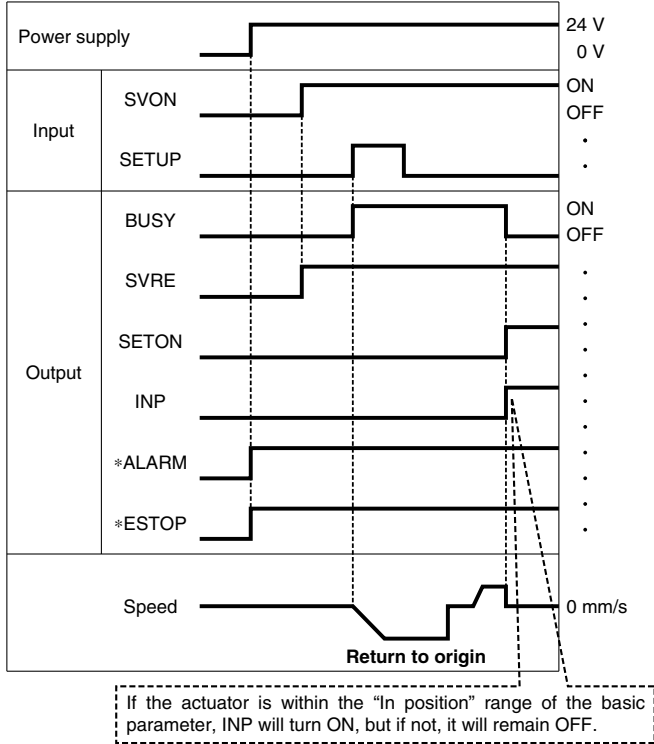

\* \*ALARM and \*ESTOP are expressed as negative-logic circuits.

### Positioning Operation

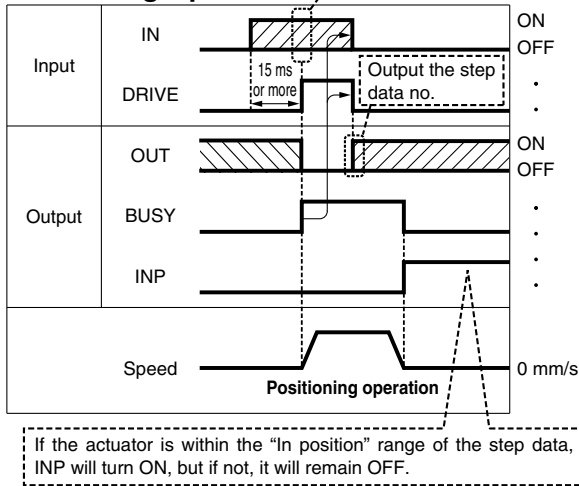

\* "OUT" is output when "DRIVE" is changed from ON to OFF. Refer to the operation manual for details on the controller for the LEM series. (When power supply is applied, "DRIVE" or "RESET" is turned ON or \*ESTOP is turned OFF, all of the "OUT" outputs are OFF.)

### HOLD

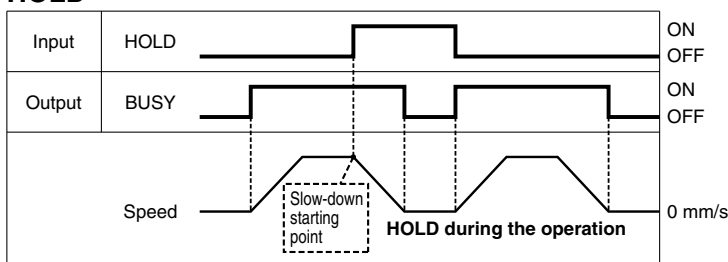

\* When the actuator is within the "In position" range in the pushing operation, it does not stop even if HOLD signal is input.

### Pushing Operation

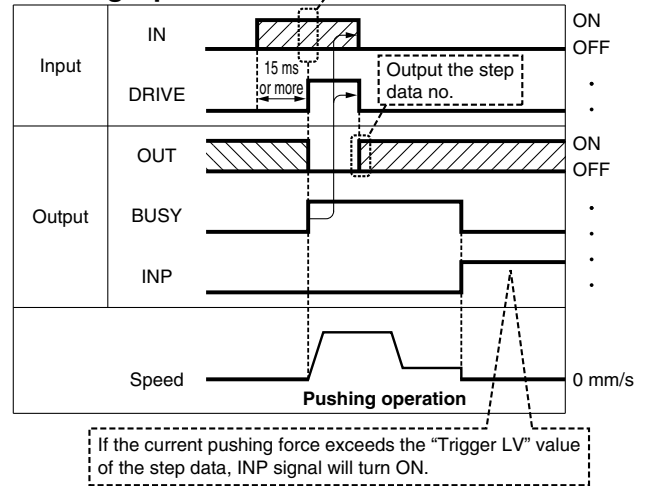

\* Check the catalog and operation manual of each actuator model which is capable of performing pushing operations. The "Specifications" table for models which are capable of performing pushing operations includes an item for the pushing force.

### Reset

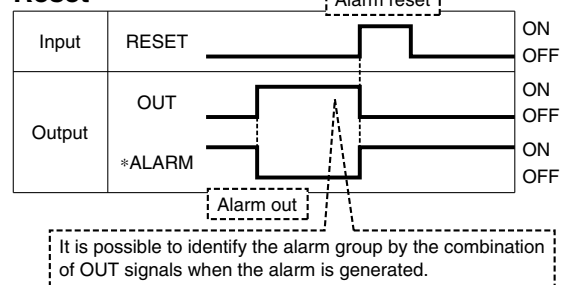

\* \*ALARM is expressed as a negative-logic circuit.

Model Selection

LEFS□F Series

LEY□F Series

Auto Switch

JXC5H/6H Series

JXCEH/9H/PH Series

# JXC5H/6H Series

## Options

### ■ Communication cable for controller setting

#### ① Communication cable JXC-W2A-C

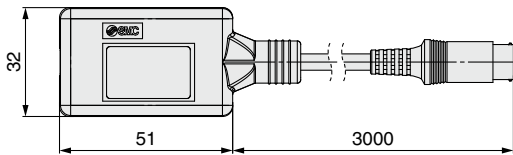

\* It can be connected to the controller directly.

#### ② USB cable LEC-W2-U

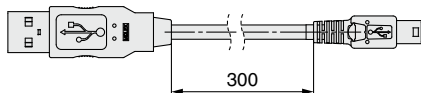

#### ③ Controller setting kit JXC-W2A

A set which includes a communication cable (JXC-W2A-C) and a USB cable (LEC-W2-U)

#### <Controller setting software/USB driver>

- Controller setting software
  - USB driver (For JXC-W2A-C)
- Download from SMC's website:  
<https://www.smcworld.com>

#### Hardware Requirements

OS	Windows®7, Windows®8.1, Windows®10, Windows®11
Communication interface	USB 1.1 or USB 2.0 ports
Display	1024 x 768 or more

\* Windows®7, Windows®8.1, Windows®10, and Windows®11 are registered trademarks of Microsoft Corporation in the United States.

### ■ Conversion cable P5062-5 (Cable length: 300 mm)



\* To connect the teaching box (LEC-T1-3□J□G□) or controller setting kit (LEC-W2□) to the controller, a conversion cable is required.

### ■ I/O cable

#### LEC-CN5-1

Cable length (L) [m]	
1	1.5
3	3
5	5

\* Conductor size: AWG28

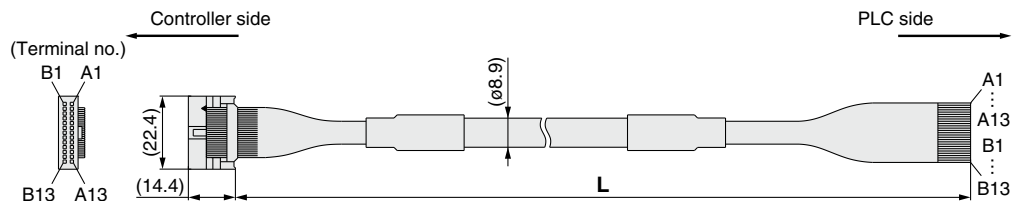

Connector pin no.	Insulation color	Dot mark	Dot color
A1	Light brown	■	Black
A2	Light brown	■	Red
A3	Yellow	■	Black
A4	Yellow	■	Red
A5	Light green	■	Black
A6	Light green	■	Red
A7	Gray	■	Black
A8	Gray	■	Red
A9	White	■	Black
A10	White	■	Red
A11	Light brown	■ ■	Black
A12	Light brown	■ ■	Red
A13	Yellow	■ ■	Black

Connector pin no.	Insulation color	Dot mark	Dot color
B1	Yellow	■ ■	Red
B2	Light green	■ ■	Black
B3	Light green	■ ■	Red
B4	Gray	■ ■	Black
B5	Gray	■ ■	Red
B6	White	■ ■	Black
B7	White	■ ■	Red
B8	Light brown	■ ■ ■	Black
B9	Light brown	■ ■ ■	Red
B10	Yellow	■ ■ ■	Black
B11	Yellow	■ ■ ■	Red
B12	Light green	■ ■ ■	Black
B13	Light green	■ ■ ■	Red
—			Shield

#### Weight

Product no.	Weight [g]
LEC-CN5-1	170
LEC-CN5-3	320
LEC-CN5-5	520

### ■ Power supply plug JXC-CPW

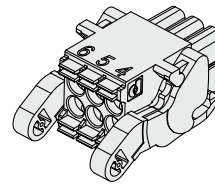

\* The power supply plug is an accessory.  
 <Applicable cable size> AWG20 (0.5 mm<sup>2</sup>), cover diameter 2.0 mm or less

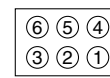

- ① C24V
- ② M24V
- ③ EMG
- ④ 0V
- ⑤ N.C.
- ⑥ LK RLS

#### Power supply plug

Terminal name	Function	Details
0V	Common supply (-)	The M24V terminal, C24V terminal, EMG terminal, and LK RLS terminal are common (-).
M24V	Motor power supply (+)	Motor power supply (+) of the controller
C24V	Control power supply (+)	Control power supply (+) of the controller
EMG	Stop (+)	Connection terminal of the external stop circuit
LK RLS	Lock release (+)	Connection terminal of the lock release switch

### ■ Teaching box

#### LEC-T1-3□J□G□

Teaching box

Cable length [m]  
 3 3

Initial language

J	Japanese
E	English

\* The displayed language can be changed to English or Japanese.

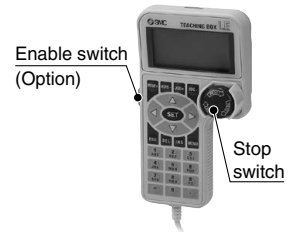

Enable switch

Nil	None
S	Equipped with enable switch

\* Interlock switch for jog and test function

Stop switch

G	Equipped with stop switch
---	---------------------------

#### Specifications

Item	Description
Switch	Stop switch, Enable switch (Option)
Cable length [m]	3
Enclosure	IP64 (Except connector)
Operating temperature range [°C]	5 to 50
Operating humidity range [%RH]	90 or less (No condensation)
Weight [g]	350 (Except cable)

# High Performance Step Motor Controller

## JXCEH/9H/PH Series



### How to Order

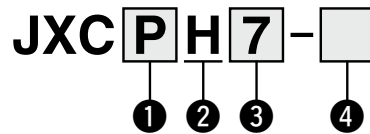

#### 1 Communication protocol

<b>E</b>	EtherCAT
<b>9</b>	EtherNet/IP™
<b>P</b>	PROFINET

#### 3 Mounting

<b>7</b>	Screw mounting
<b>8*1</b>	DIN rail

\*1 The DIN rail is not included. It must be ordered separately. (Refer to page 71.)

#### 2 Specifications

<b>H</b>	1 axis/High performance type
----------	------------------------------

#### 4 Actuator part number

Without cable specifications and actuator options  
Example: Enter "LEFS16FB-100" for the LEFS16FB-100B-S1□.

<b>BC</b>	Blank controller*1
-----------	--------------------

\*1 Requires dedicated software (JXC-BCW)  
\* Configuration of the ACT Controller 2 is possible using Windows 10 and 11.  
With Windows 7 and 8, the configuration is by means of dedicated software (JXC-BCW).



EtherCAT → EtherNet/IP



Model Selection

LEFS□F Series

LEY□F Series

Auto Switch

JXC5H/6H Series

JXCEH/9H/PH Series

### The controller is sold as single unit after the compatible actuator is set.

Confirm that the combination of the controller and actuator is correct.

- Check the actuator label for the model number. This number should match that of the controller.

LEFS16FB-400

①

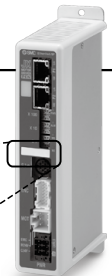

\* Refer to the operation manual for using the products. Please download it via our website: <https://www.smcworld.com>

### Precautions for blank controllers (JXC□H□-BC)

A blank controller is a controller to which the customer can write the data of the actuator it is to be combined and used with. For data writing, use the controller setting software ACT Controller 2 or the dedicated software JXC-BCW.

- Both ACT Controller 2 and JXC-BCW can be downloaded from the SMC website.
- To use this software, order the communication cable for controller setting (JXC-W2A-C) and the USB cable (LEC-W2-U) separately.

#### Hardware Requirements

OS	Windows®10 (64 bit)	Windows®11	Windows®7	Windows®8	Windows®10
Software	ACT Controller 2 (With JXC-BCW function)		JXC-BCW		

\* Windows®7, Windows®8, Windows®10, and Windows®11 are registered trademarks of Microsoft Corporation in the United States.

SMC website: <https://www.smcworld.com>

### ⚠ Caution

#### [CE/UKCA-compliant products]

- EMC compliance was tested by combining the electric actuator LE series and the JXCEH/PH series.

The EMC depends on the configuration of the customer's control panel and the relationship with other electrical equipment and wiring. Therefore, compliance with the EMC directive cannot be certified for SMC components incorporated into the customer's equipment under actual operating conditions. As a result, it is necessary for the customer to verify compliance with the EMC directive for the machinery and equipment as a whole.

- For the JXCEH/PH series (step motor controller), EMC compliance was tested by installing a noise filter set (LEC-NFA). Refer to page 72 for the noise filter set. Refer to the JXCEH/PH Operation Manual for installation.

# JXCEH/9H/PH Series

## Specifications

Model		JXCEH	JXC9H	JXCPH	
Network		EtherCAT	EtherNet/IP™	PROFINET	
Compatible motor		Step motor (Servo/24 VDC)			
Power supply		Power voltage: 24 VDC ±10%			
Current consumption (Controller)		200 mA or less	200 mA or less	200 mA or less	
Compatible encoder		Incremental			
Communication specifications	Applicable system	Protocol	EtherCAT*2	EtherNet/IP™*2	PROFINET*2
		Version*1	Conformance Test Record V.1.2.6	Volume 1 (Edition 3.14) Volume 2 (Edition 1.15)	Specification Version 2.32
	Communication speed	100 Mbps*2	10/100 Mbps*2 (Automatic negotiation)	100 Mbps*2	
	Configuration file*3	ESI file	EDS file	GSDML file	
	I/O occupation area	Input 20 bytes Output 36 bytes	Input 36 bytes Output 36 bytes	Input 36 bytes Output 36 bytes	
	Terminating resistor	Not included			
Memory		EEPROM			
LED indicator		PWR, RUN, ALM, ERR	PWR, ALM, MS, NS	PWR, ALM, SF, BF	
Cable length [m]		Actuator cable: 20 or less			
Cooling system		Natural air cooling			
Operating temperature range [°C]		0 to 40 (No freezing)			
Operating humidity range [%RH]		90 or less (No condensation)			
Enclosure		IP30 (Excludes the connector)			
Insulation resistance [MΩ]		Between all external terminals and the case: 50 (500 VDC)			
Weight [g]		260 (Screw mounting) 280 (DIN rail mounting)	250 (Screw mounting) 270 (DIN rail mounting)	260 (Screw mounting) 280 (DIN rail mounting)	

\*1 Please note that versions are subject to change.

\*2 Use a shielded communication cable with CAT5 or higher for the PROFINET, EtherNet/IP™, and EtherCAT.

\*3 The files can be downloaded from the SMC website.

### ■ Trademark

EtherNet/IP® is a registered trademark of ODVA, Inc.

EtherCAT® is registered trademark and patented technology, licensed by Beckhoff Automation GmbH, Germany.

## Example of Operation Command

In addition to the step data input of 64 points maximum in each communication protocol, the changing of each parameter can be performed in real time via numerical data defined operation.

\* Numerical values other than "Moving force," "Area 1," and "Area 2" can be used to perform operation under numerical instructions from JXCL1.

### <Application example> Movement between 2 points

No.	Movement mode	Speed	Position	Acceleration	Deceleration	Pushing force	Trigger LV	Pushing speed	Moving force	Area 1	Area 2	In position
0	1: Absolute	100	10	3000	3000	0	0	0	100	0	0	0.50
1	1: Absolute	100	100	3000	3000	0	0	0	100	0	0	0.50

### <Step no. defined operation>

Sequence 1: Servo ON instruction

Sequence 2: Instruction to return to origin

Sequence 3: Specify step data No. 0 to input the DRIVE signal.

Sequence 4: Specify step data No. 1 after the DRIVE signal has been temporarily turned OFF to input the DRIVE signal.

### <Numerical data defined operation>

Sequence 1: Servo ON instruction

Sequence 2: Instruction to return to origin

Sequence 3: Specify step data No. 0 and turn ON the input instruction flag (position). Input 10 in the target position. Subsequently the start flag turns ON.

Sequence 4: Turn ON step data No. 0 and the input instruction flag (position) to change the target position to 100 while the start flag is ON.

The same operation can be performed with any operation command.

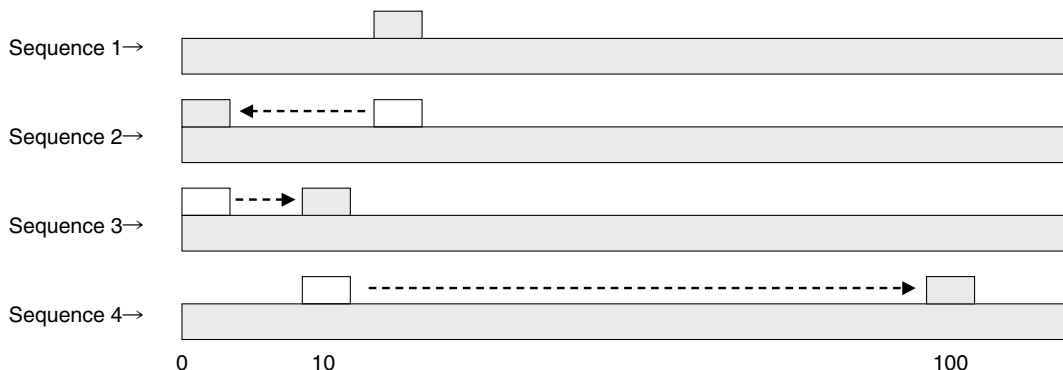

**Dimensions**

**JXCEH**

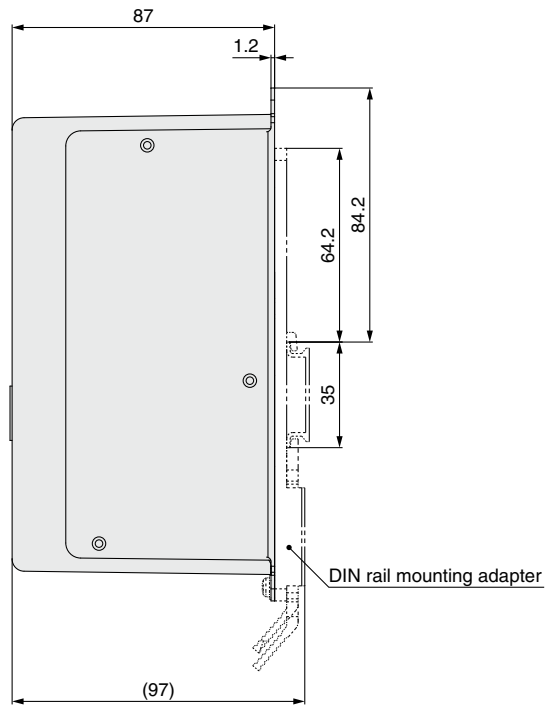
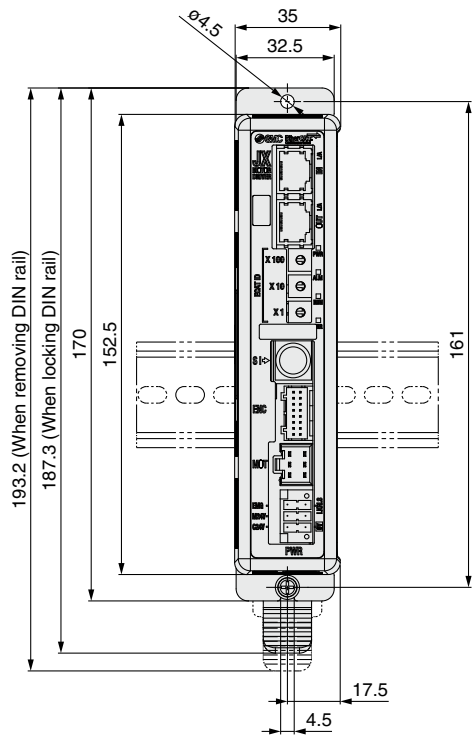

**JXC9H**

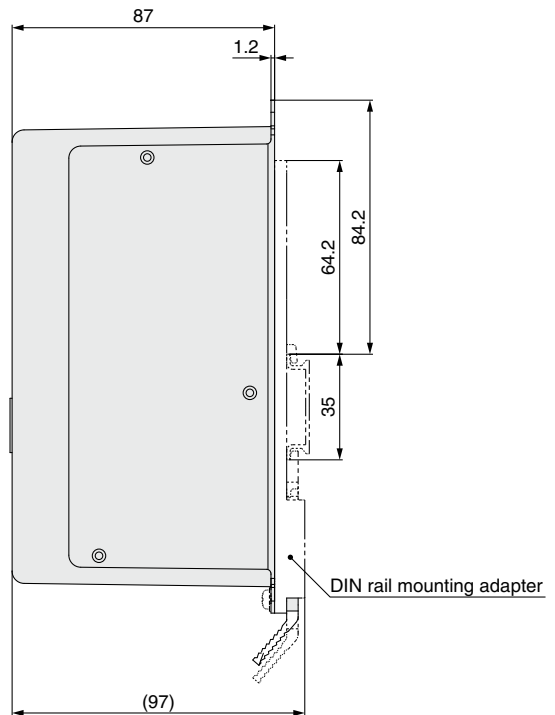
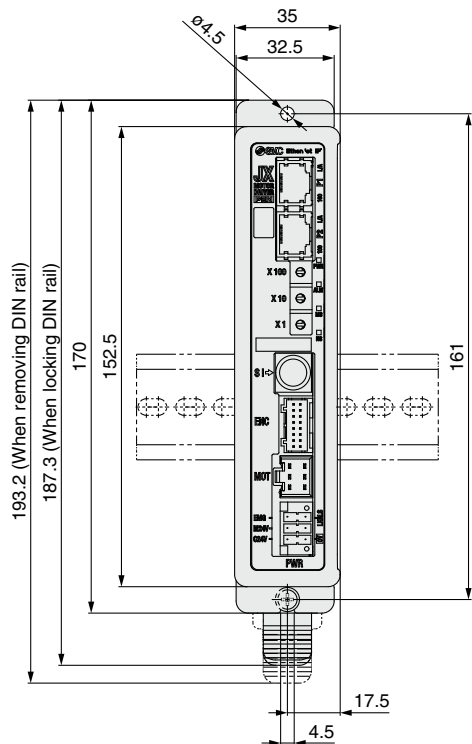

Model Selection

LEFS□F Series

LEY□F Series

Auto Switch

JXC5H/6H Series

JXCEH/9H/PH Series

# JXCEH/9H/PH Series

## Dimensions

### JXCPH

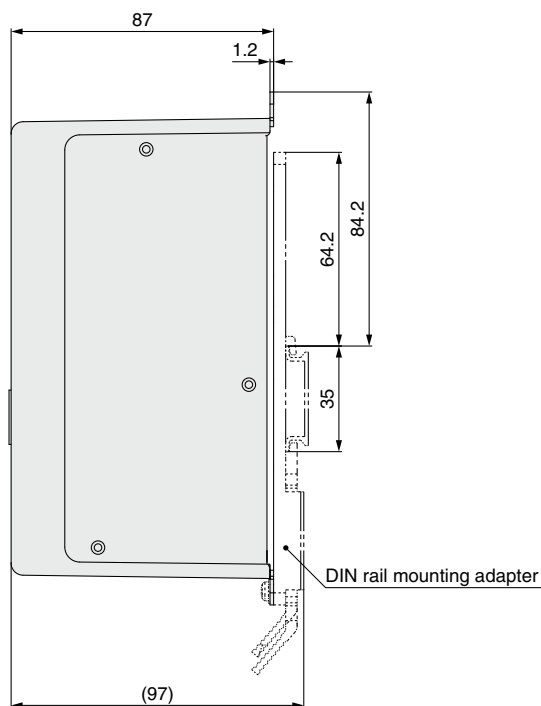
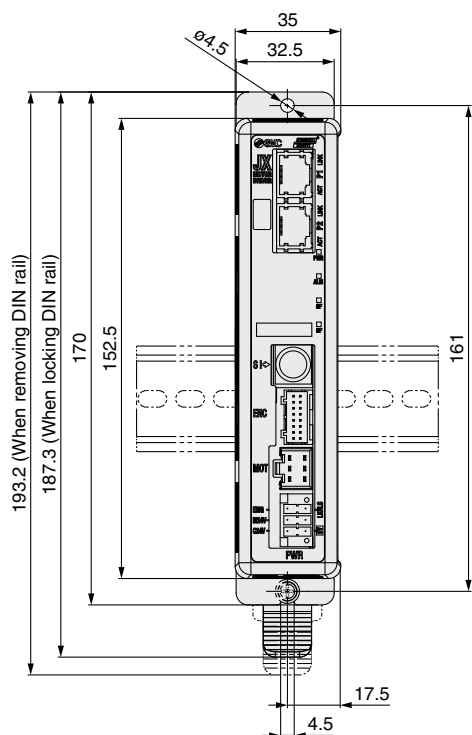

### DIN rail

#### AXT100-DR-□

\* For □, enter a number from the No. line in the table below.  
Refer to the dimension drawings on pages 70 and 71 for the mounting dimensions.

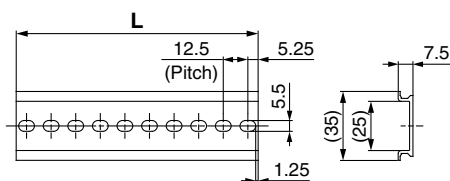

#### L Dimensions [mm]

No.	1	2	3	4	5	6	7	8	9	10	11	12	13	14	15	16	17	18	19	20
L	23	35.5	48	60.5	73	85.5	98	110.5	123	135.5	148	160.5	173	185.5	198	210.5	223	235.5	248	260.5
No.	21	22	23	24	25	26	27	28	29	30	31	32	33	34	35	36	37	38	39	40
L	273	285.5	298	310.5	323	335.5	348	360.5	373	385.5	398	410.5	423	435.5	448	460.5	473	485.5	498	510.5

### DIN rail mounting adapter

#### LEC-3-D0 (with 2 mounting screws)

This should be used when the DIN rail mounting adapter is mounted onto a screw mounting type controller afterward.



## Options

### ■ Communication cable for controller setting

#### ① Communication cable JXC-W2A-C

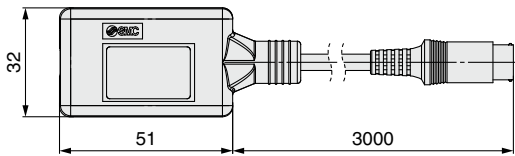

\* It can be connected to the controller directly.

#### ② USB cable LEC-W2-U

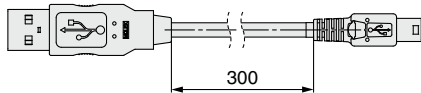

#### ③ Controller setting kit JXC-W2A

A set which includes a communication cable (JXC-W2A-C) and a USB cable (LEC-W2-U)

#### <Controller setting software/USB driver>

- Controller setting software
- USB driver (For JXC-W2A-C)

Download from SMC's website: <https://www.smcworld.com>

#### Hardware Requirements

OS	Windows®7, Windows®8.1, Windows®10, Windows®11
Communication interface	USB 1.1 or USB 2.0 ports
Display	1024 x 768 or more

\* Windows®7, Windows®8.1, Windows®10, and Windows®11 are registered trademarks of Microsoft Corporation in the United States.

### ■ DIN rail mounting adapter LEC-3-D0

\* With 2 mounting screws

This should be used when the DIN rail mounting adapter is mounted onto a screw mounting type controller afterward.

### ■ DIN rail AXT100-DR-□

\* For □, enter a number from the No. line in the table on page 71. Refer to the dimension drawings on pages 70 and 71 for the mounting dimensions.

### ■ Teaching box

## LEC-T1-3 J G □

Teaching box

Cable length [m]

3	3
---	---

Initial language

J	Japanese
E	English

\* The displayed language can be changed to English or Japanese.

Enable switch (Option)



Enable switch

Nil	None
S	Equipped with enable switch

\* Interlock switch for jog and test function

Stop switch

G	Equipped with stop switch
---	---------------------------

#### Specifications

Item	Description
Switch	Stop switch, Enable switch (Option)
Cable length [m]	3
Enclosure	IP64 (Except connector)
Operating temperature range [°C]	5 to 50
Operating humidity range [%RH]	90 or less (No condensation)
Weight [g]	350 (Except cable)

### ■ Power supply plug JXC-CPW

\* The power supply plug is an accessory.

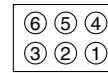
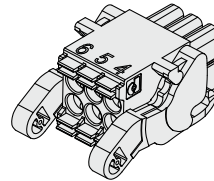

- |        |          |
|--------|----------|
| ① C24V | ④ 0V     |
| ② M24V | ⑤ N.C.   |
| ③ EMG  | ⑥ LK RLS |

#### Power supply plug

Terminal name	Function	Details
0V	Common supply (-)	The M24V terminal, C24V terminal, EMG terminal, and LK RLS terminal are common (-).
M24V	Motor power supply (+)	Motor power supply (+) of the controller
C24V	Control power supply (+)	Control power supply (+) of the controller
EMG	Stop (+)	Connection terminal of the external stop circuit
LK RLS	Lock release (+)	Connection terminal of the lock release switch

### ■ Conversion cable P5062-5 (Cable length: 300 mm)

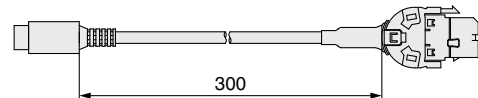

\* To connect the teaching box (LEC-T1-3□G□) or controller setting kit (LEC-W2) to the controller, a conversion cable is required.

### ■ Noise filter set

## LEC-NFA

Contents of the set: 2 noise filters

(Manufactured by WURTH ELEKTRONIK: 74271222)

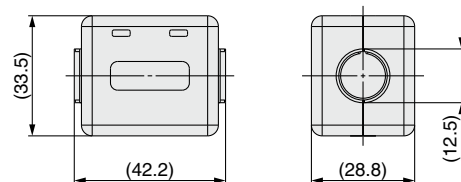

\* Refer to the JXCEH/PH series Operation Manual for installation.

# JXC5H/6H Series JXCEH/9H/PH Series Actuator Cable (Option)

[Robotic cable, standard cable for step motor (Servo/24 VDC)]

LE-CP-1-□

Cable length (L) [m]

1	1.5
3	3
5	5
8	8*1
A	10*1
B	15*1
C	20*1

\*1 Produced upon receipt of order (Robotic cable only)

Cable type

Nil	Robotic cable (Flexible cable)
S	Standard cable

Weight

Product no.	Weight [g]	Note
LE-CP-1-S	190	Standard cable
LE-CP-3-S	280	
LE-CP-5-S	460	
LE-CP-1	140	Robotic cable
LE-CP-3	260	
LE-CP-5	420	
LE-CP-8	790	
LE-CP-A	980	
LE-CP-B	1460	
LE-CP-C	1940	

LE-CP-<sup>1</sup>/<sub>5</sub>/Cable length: 1.5 m, 3 m, 5 m

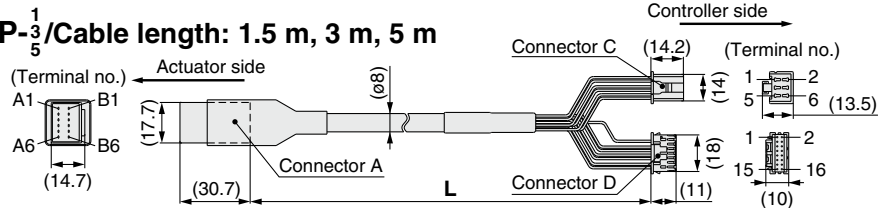

LE-CP-<sup>8 B</sup>/<sub>A C</sub>/Cable length: 8 m, 10 m, 15 m, 20 m  
(\*1 Produced upon receipt of order)

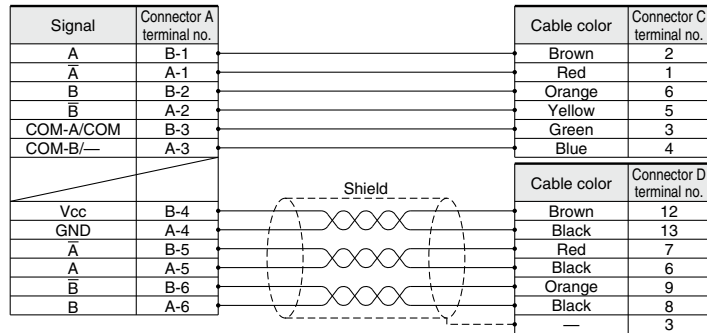
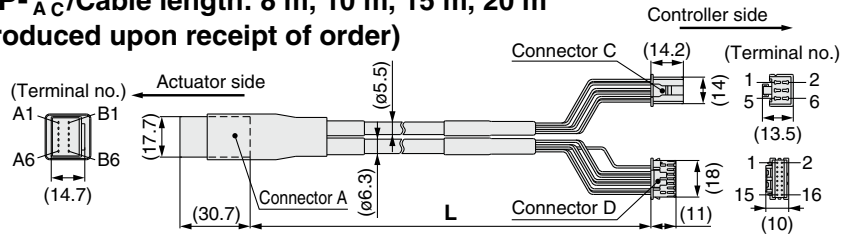

[Robotic cable, standard cable with lock and sensor for step motor (Servo/24 VDC)]

LE-CP-1-B-□

Cable length (L) [m]

1	1.5
3	3
5	5
8	8*1
A	10*1
B	15*1
C	20*1

\*1 Produced upon receipt of order (Robotic cable only)

With lock and sensor

Cable type

Nil	Robotic cable (Flexible cable)
S	Standard cable

Weight

Product no.	Weight [g]	Note
LE-CP-1-B-S	240	Standard cable
LE-CP-3-B-S	380	
LE-CP-5-B-S	630	
LE-CP-1-B	190	Robotic cable
LE-CP-3-B	360	
LE-CP-5-B	590	
LE-CP-8-B	1060	
LE-CP-A-B	1320	
LE-CP-B-B	1920	
LE-CP-C-B	2620	

LE-CP-<sup>1</sup>/<sub>5</sub>/Cable length: 1.5 m, 3 m, 5 m

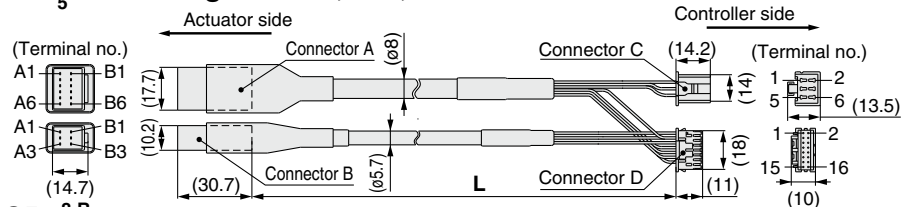

LE-CP-<sup>8 B</sup>/<sub>A C</sub>/Cable length: 8 m, 10 m, 15 m, 20 m  
(\*1 Produced upon receipt of order)

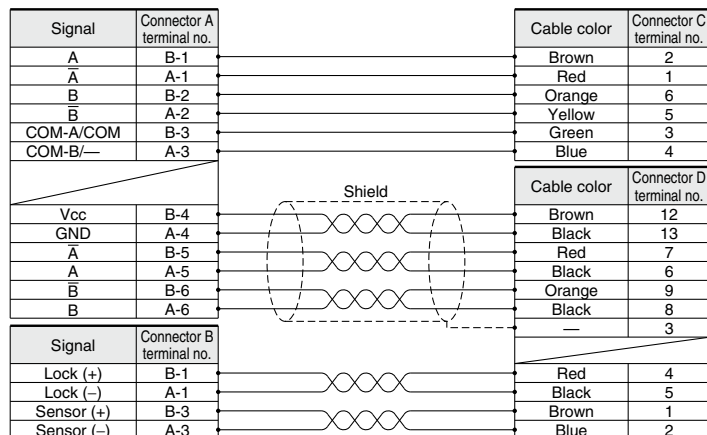
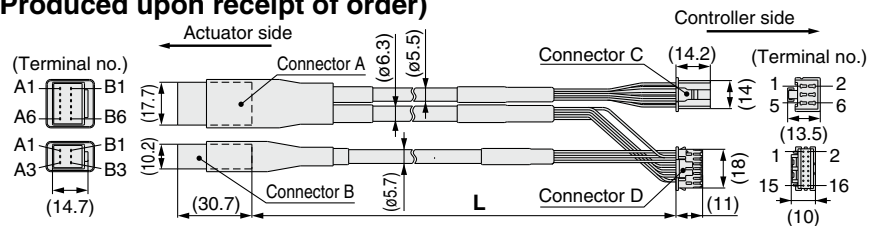



# JXC5H/6H/EH/9H/PH Series

## Precautions Relating to Differences in Controller Versions

As the controller version of the JXC series differs, the internal parameters are not compatible.

- If using the JXC□1□-BC or JXC□1□-BC-E, please use the latest version of the JXC-BCW (parameter writing tool).
- There are currently 3 versions available: version 1 products (V1.□ or S1.□), version 2 products (V2.□ or S2.□), and version 3 products (V3.□ or S3.□). Keep in mind that in order to write a backup file (.bcp) to another controller with the JXC-BCW, it needs to be the same version as the controller that created the file. (For example, a backup file created by a version 1 product can only be written to another version 1 product, and so on.) A backup file for the electric actuator with battery-less absolute encoder can only be written between version 3.4 or higher product (the backup file of version 2 or earlier products cannot be written).

### Identifying Version Symbols

#### JXC□1 Series Version V3.□ or S3.□ Products

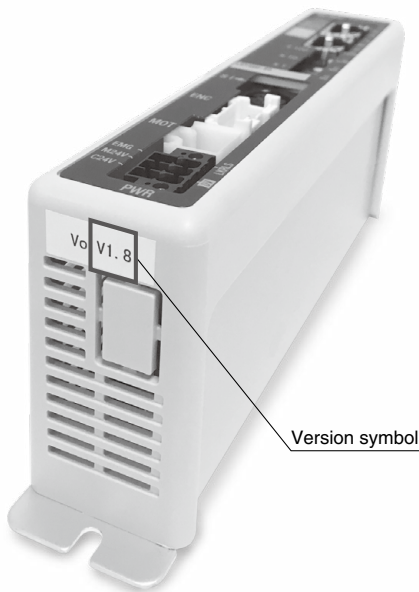

XR V3.0

#### Applicable models

JXC91□ Series

XR S3.0 T1.0

#### Applicable models

JXC51/61□ Series  
 JXCE1□ Series  
 JXCP1□ Series  
 JXCD1□ Series  
 JXCL1□ Series  
 JXCM1□ Series

#### JXC□1 Series Version V2.□ or S2.□ Products

WP V2.1

#### Applicable models

JXC91□ Series

WP S2.2 T1.1

#### Applicable models

JXCE1□ Series  
 JXCP1□ Series  
 JXCD1□ Series  
 JXCL1□ Series

#### JXC□1 Series Version V1.□ or S1.□ Products

XR V1.0

#### Applicable models

JXC91□ Series

XR S1.0 T1.0

#### Applicable models

JXCE1□ Series  
 JXCP1□ Series  
 JXCD1□ Series  
 JXCL1□ Series

#### ■ Trademark

EtherNet/IP® is a registered trademark of ODVA, Inc.  
 DeviceNet® is a registered trademark of ODVA, Inc.  
 EtherCAT® is registered trademark and patented technology, licensed by Beckhoff Automation GmbH, Germany.

Model Selection

LEFS□F Series

LEY□F Series

Auto Switch

JXC5H/6H Series

JXCEH/9H/PH Series

# CE/UKCA/UL-compliance List

\* For CE, UKCA, and UL-compliant products, refer to the tables below.

As of February 2022

## ■ Controllers "○": Compliant "x": Not compliant

Compatible motor	Series	CE UK CA	cUL <sup>us</sup>	
			Compliance	Certification No. (File No.)
High performance (Step motor 24 VDC)	JXC5H/6H	○	○	E480340
	JXCEH	○	○	E480340
	JXC9H	○	○	E480340
	JXCPH	○	○	E480340

## ■ Actuators "○": Compliant "x": Not compliant

Compatible motor	Series	CE UK CA	cUL <sup>us</sup>	
			Compliance	Certification No. (File No.)
High performance (Step motor 24 VDC)	LEFS□F	○	x	—
	LEY□F	○	x	—

## ■ Actuators (When ordered with a controller) "○": Compliant "x": Not compliant "—": Not applicable

Compatible motor	Series	JXC5H/6H				JXCEH				JXC9H				JXCPH			
		CE UK CA		cUL <sup>us</sup>		CE UK CA		cUL <sup>us</sup>		CE UK CA		cUL <sup>us</sup>		CE UK CA		cUL <sup>us</sup>	
		Compliance	Certification No. (File No.)	Compliance	Certification No. (File No.)	Compliance	Certification No. (File No.)	Compliance	Certification No. (File No.)	Compliance	Certification No. (File No.)	Compliance	Certification No. (File No.)	Compliance	Certification No. (File No.)		
High performance (Step motor 24 VDC)	LEF□F	○	○	E339743	○	○	E339743	○	○	E339743	○	○	E339743	○	○	E339743	
	LEY□F	○	○	E339743	○	○	E339743	○	○	E339743	○	○	E339743	○	○	E339743	

## Safety Instructions

These safety instructions are intended to prevent hazardous situations and/or equipment damage. These instructions indicate the level of potential hazard with the labels of “**Caution**,” “**Warning**” or “**Danger**.” They are all important notes for safety and must be followed in addition to International Standards (ISO/IEC)\*1), and other safety regulations.

 **Caution:** **Caution** indicates a hazard with a low level of risk which, if not avoided, could result in minor or moderate injury.

 **Warning:** **Warning** indicates a hazard with a medium level of risk which, if not avoided, could result in death or serious injury.

 **Danger :** **Danger** indicates a hazard with a high level of risk which, if not avoided, will result in death or serious injury.

\*1) ISO 4414: Pneumatic fluid power – General rules relating to systems.  
ISO 4413: Hydraulic fluid power – General rules relating to systems.  
IEC 60204-1: Safety of machinery – Electrical equipment of machines.  
(Part 1: General requirements)  
ISO 10218-1: Manipulating industrial robots – Safety.  
etc.

### Warning

#### 1. The compatibility of the product is the responsibility of the person who designs the equipment or decides its specifications.

Since the product specified here is used under various operating conditions, its compatibility with specific equipment must be decided by the person who designs the equipment or decides its specifications based on necessary analysis and test results. The expected performance and safety assurance of the equipment will be the responsibility of the person who has determined its compatibility with the product. This person should also continuously review all specifications of the product referring to its latest catalog information, with a view to giving due consideration to any possibility of equipment failure when configuring the equipment.

#### 2. Only personnel with appropriate training should operate machinery and equipment.

The product specified here may become unsafe if handled incorrectly. The assembly, operation and maintenance of machines or equipment including our products must be performed by an operator who is appropriately trained and experienced.

#### 3. Do not service or attempt to remove product and machinery/equipment until safety is confirmed.

1. The inspection and maintenance of machinery/equipment should only be performed after measures to prevent falling or runaway of the driven objects have been confirmed.
2. When the product is to be removed, confirm that the safety measures as mentioned above are implemented and the power from any appropriate source is cut, and read and understand the specific product precautions of all relevant products carefully.
3. Before machinery/equipment is restarted, take measures to prevent unexpected operation and malfunction.

#### 4. Contact SMC beforehand and take special consideration of safety measures if the product is to be used in any of the following conditions.

1. Conditions and environments outside of the given specifications, or use outdoors or in a place exposed to direct sunlight.
2. Installation on equipment in conjunction with atomic energy, railways, air navigation, space, shipping, vehicles, military, medical treatment, combustion and recreation, or equipment in contact with food and beverages, emergency stop circuits, clutch and brake circuits in press applications, safety equipment or other applications unsuitable for the standard specifications described in the product catalog.
3. An application which could have negative effects on people, property, or animals requiring special safety analysis.
4. Use in an interlock circuit, which requires the provision of double interlock for possible failure by using a mechanical protective function, and periodical checks to confirm proper operation.

### Caution

#### 1. The product is provided for use in manufacturing industries.

The product herein described is basically provided for peaceful use in manufacturing industries.  
If considering using the product in other industries, consult SMC beforehand and exchange specifications or a contract if necessary.  
If anything is unclear, contact your nearest sales branch.

## Limited warranty and Disclaimer/ Compliance Requirements

The product used is subject to the following “Limited warranty and Disclaimer” and “Compliance Requirements”.

Read and accept them before using the product.

### Limited warranty and Disclaimer

1. The warranty period of the product is 1 year in service or 1.5 years after the product is delivered, whichever is first.\*2)  
Also, the product may have specified durability, running distance or replacement parts. Please consult your nearest sales branch.
2. For any failure or damage reported within the warranty period which is clearly our responsibility, a replacement product or necessary parts will be provided.  
This limited warranty applies only to our product independently, and not to any other damage incurred due to the failure of the product.
3. Prior to using SMC products, please read and understand the warranty terms and disclaimers noted in the specified catalog for the particular products.

#### \*2) Vacuum pads are excluded from this 1 year warranty.

A vacuum pad is a consumable part, so it is warranted for a year after it is delivered.  
Also, even within the warranty period, the wear of a product due to the use of the vacuum pad or failure due to the deterioration of rubber material are not covered by the limited warranty.

### Compliance Requirements

1. The use of SMC products with production equipment for the manufacture of weapons of mass destruction (WMD) or any other weapon is strictly prohibited.
2. The exports of SMC products or technology from one country to another are governed by the relevant security laws and regulations of the countries involved in the transaction. Prior to the shipment of a SMC product to another country, assure that all local rules governing that export are known and followed.

### Caution

#### SMC products are not intended for use as instruments for legal metrology.

Measurement instruments that SMC manufactures or sells have not been qualified by type approval tests relevant to the metrology (measurement) laws of each country. Therefore, SMC products cannot be used for business or certification ordained by the metrology (measurement) laws of each country.

### Revision History

**Edition B** \* The rod type LEY□F series has been added.  
\* The number of pages has been increased from 36 to 80.

AW

 **Safety Instructions** Be sure to read the “Handling Precautions for SMC Products” (M-E03-3) and “Operation Manual” before use.

# SMC Corporation

Akihabara UDX 15F,  
4-14-1, Sotokanda, Chiyoda-ku, Tokyo 101-0021, JAPAN  
Phone: 03-5207-8249 Fax: 03-5298-5362  
<https://www.smcworld.com>  
© 2022 SMC Corporation All Rights Reserved

Specifications are subject to change without prior notice and any obligation on the part of the manufacturer.

D-G