

3-Screen Display

Sensor Monitor

New



Compact Pneumatic Pressure Sensor
PSE54□



Low Differential Pressure Sensor
PSE55



Pressure Sensor for General Fluids
PSE57□

Compatible with 5 types of pressure sensor



Compact Pneumatic Pressure Sensor
PSE53□



Pressure Sensor for General Fluids
PSE56□

It is possible to change the settings while checking the measured value.

Main screen	
Measured value (Current pressure value)	
Sub screen	
Left side	Right side
Label (Display item)	Set value (Threshold value)

Visualization of Settings

Set value (Threshold value)	P.L	Hysteresis value	H.L
Peak value	H.H	Bottom value	H.Lo

NPN/PNP Switch Function

1 sensor monitor for 2 output types reduces stock.

Input Range Selection (for Pressure/Flow rate)

- Set the displayed value according to the sensor input.
(Voltage input: 1 to 5 V/Current input: 4 to 20 mA)
- Value is displayed regardless of the pressure switch or flow switch.

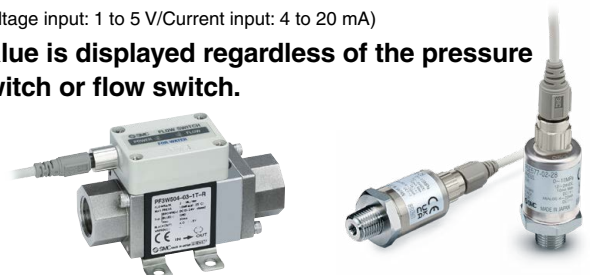

PSE300A Series

Improved Operability

Visualization of Settings

The sub screen (label) shows the item to be set.

Always displayed on one screen

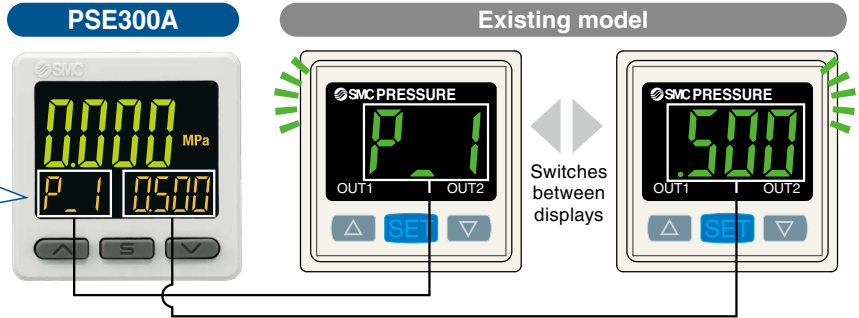

Mode Examples	Hysteresis mode		Reversed output		Hysteresis			
	Normal output	Set value (Threshold value)	Set value (Threshold value)	Set value (Threshold value)	Set value (Threshold value)	Set value (Threshold value)		
	P_1	0500	n_1	0500	H_1	0050		
Window comparator mode	Normal output/Lo side		Normal output/Hi side		Reversed output/Lo side		Reversed output/Hi side	
	Set value (Threshold value)	Set value (Threshold value)	Set value (Threshold value)	Set value (Threshold value)	Set value (Threshold value)	Set value (Threshold value)	Set value (Threshold value)	
	P_L	0300	P_H	0500	n_L	0300	n_H	0500

Simple 3-Step Setting

When the S button is pressed and the set value (P_1) is being displayed, the set value (threshold value) can be set. When the S button is pressed and the hysteresis (H_1) is being displayed, the hysteresis value can be set.

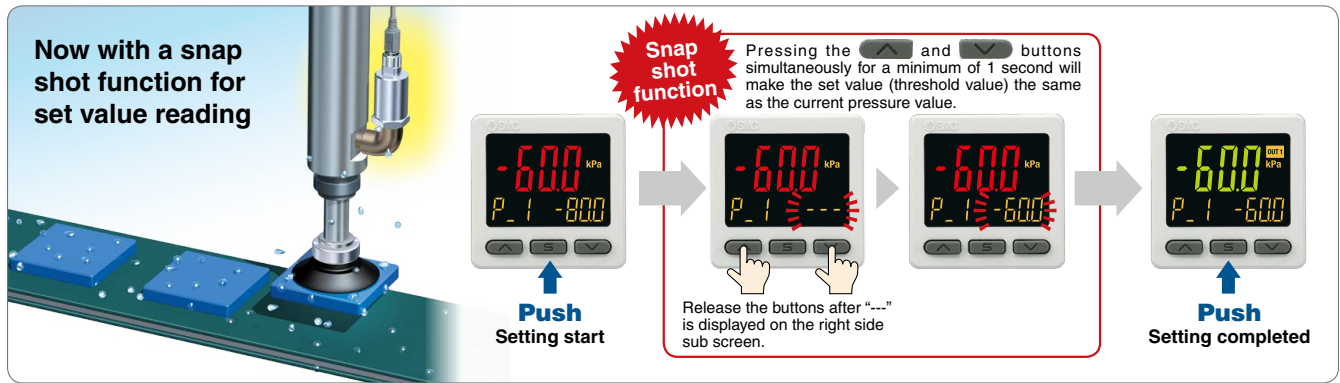
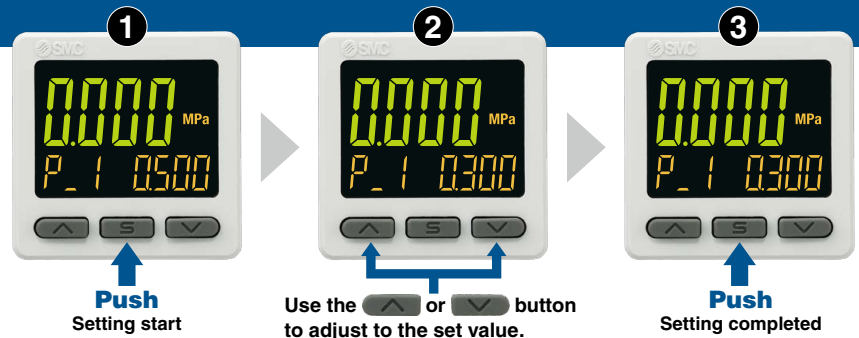

Easy Screen Switching

It is possible to change the settings while checking the measured value.

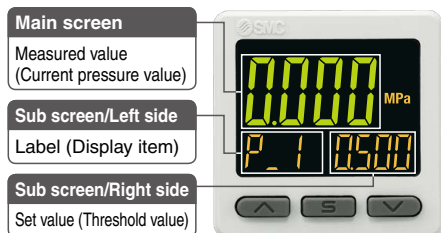

The sub screen can be switched by pressing the up/down buttons.

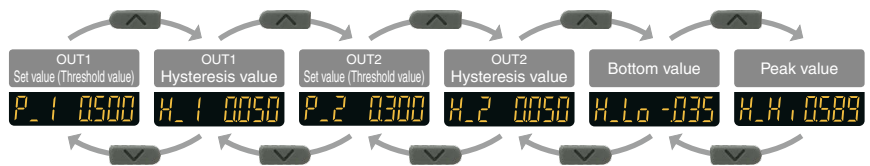

* One additional arbitrary display mode can be added via the function settings.

Copy Function

The set values of the sensor can be copied.

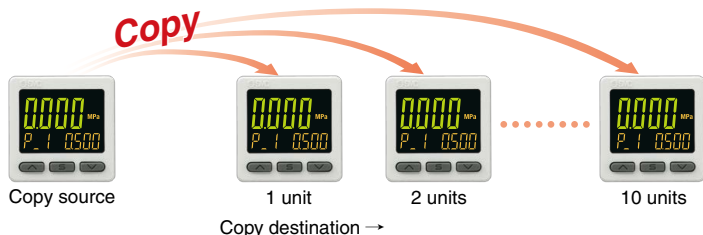

Easy Fitting of Connector

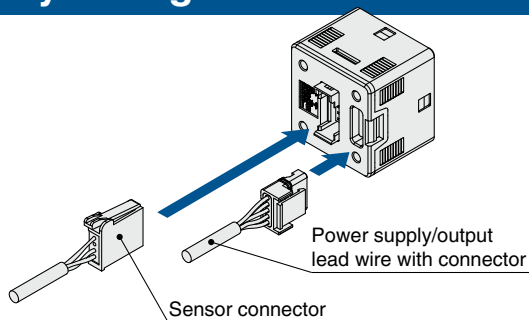

Input Range Selection (for Pressure/Flow rate)

The displayed value to the sensor input can be set as required.

(Voltage input: 1 to 5 V/Current input: 4 to 20 mA)

Pressure switch/Flow switch can be displayed.

A is displayed for 1 V (or 4 mA).
B is displayed for 5 V (or 20 mA).
The range can be set as required.

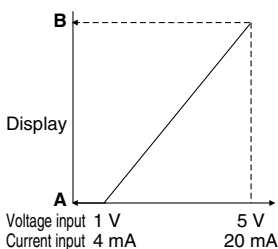

■ For Digital Flow Switch for Water/PF3W511

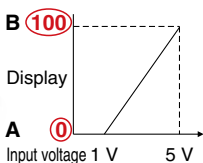

	A	B
PF3W504	0	4
PF3W520	0	16
PF3W540	0	40
PF3W511	0	100

Set A and B to the values shown in the table on the left.

Analog Free Span Function

For the displayed value, the analog span point (5 V, 20 mA) can be changed within the rated pressure range of 10 to 105%*1.

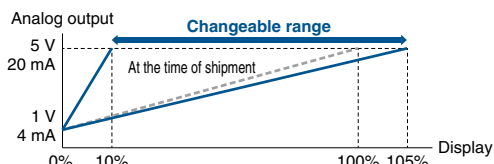

*1 Up to the upper limit of the display/set pressure range.

[Application example]

To output 5 V from the pressure controller at 0.75 MPa, using a sensor that outputs 1 to 5 V at 0 to 1 MPa.

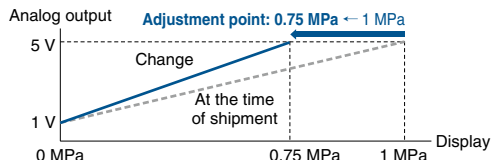

Application Example

Centralized control of distributed pressure switches is possible.

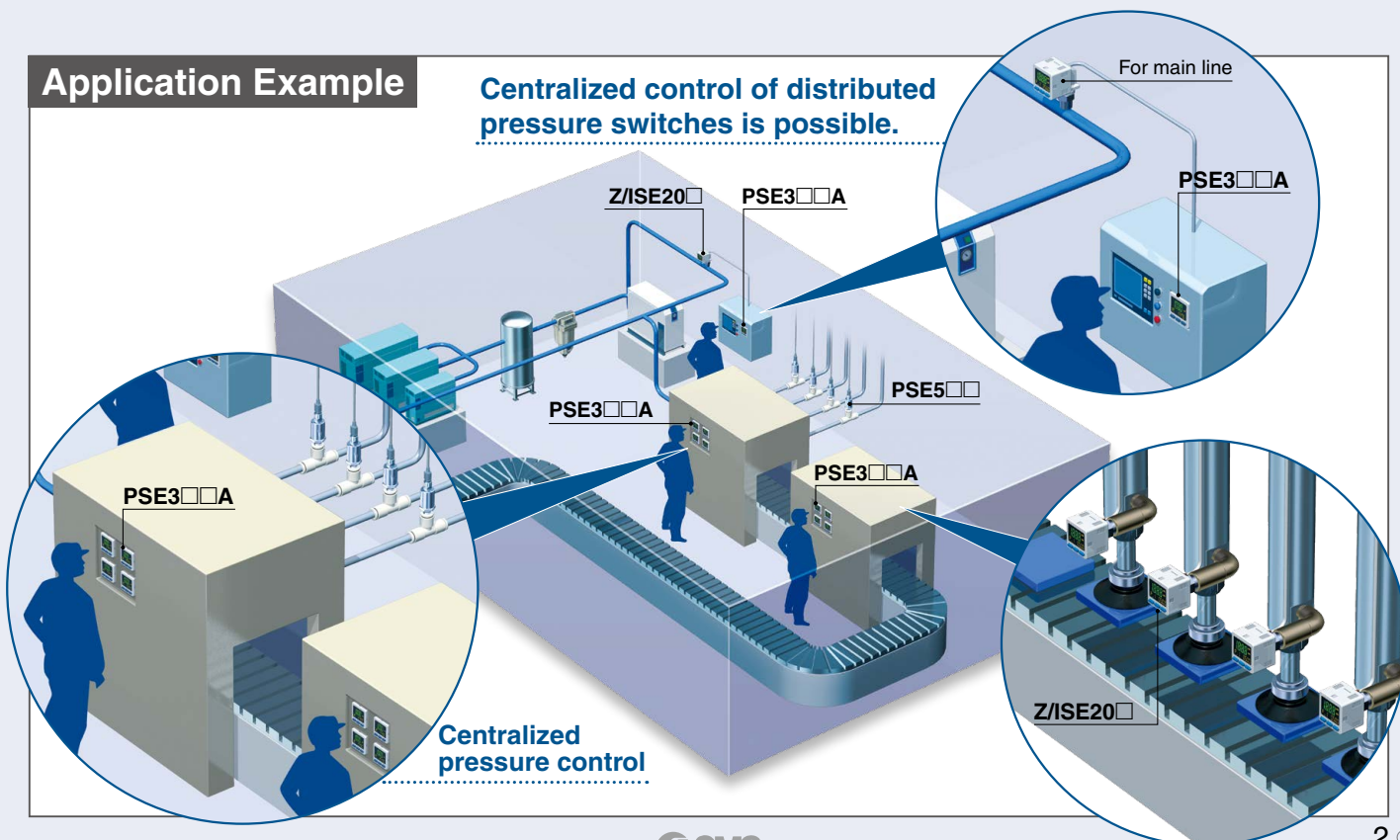

Series Variations

		Digital Sensor Monitor				
		PSE300A	PSE200A	PSE300AC		
						
Basic Specifications	Repeatability	±0.1% (F.S.)	±0.1% (F.S.)			
	Voltage	12 to 24 VDC	12 to 24 VDC			
	No. of outputs for switch	2 outputs	5 outputs	2 outputs		
	Analog output	1 to 5 V 4 to 20 mA	—			
	Operating temperature	0 to 50°C	0 to 50°C			
Functions	Number of screens	3	3			
	Enclosure	IP40	Front face: IP65 Others: IP40	IP65		
	3-step setting	Yes	Yes			
	Wiring	Connector	Connector			
Applicable Pressure Sensors	Refer to the Web Catalog for details.	Compact Pneumatic Pressure Sensor PSE53 □	Compact Pneumatic Pressure Sensor PSE54 □	Low Differential Pressure Sensor PSE550	Pressure Sensor for General Fluids PSE56 □	Pressure Sensor for General Fluids PSE57 □
						
		Rated pressure range	Rated pressure range	Rated pressure range	Rated pressure range	Rated pressure range
		-101 kPa to 0 -100 kPa to 100 kPa 0 to 100 kPa 0 to 1 MPa	-101 kPa to 0 -100 kPa to 100 kPa 0 to 1 MPa	0 to 2 kPa	-101 kPa to 0 -100 kPa to 100 kPa 0 to 500 kPa 0 to 1 MPa	-100 kPa to 100 kPa 0 to 500 kPa 0 to 1 MPa 0 to 2 MPa 0 to 5 MPa 0 to 10 MPa

CONTENTS

How to Order	p. 4	Internal Circuits and Wiring Examples	p. 6
Options/Part Nos.	p. 4	Dimensions	p. 7
Specifications	p. 5	Function Details	p. 10

3-Screen Display Sensor Monitor

PSE300A Series



How to Order

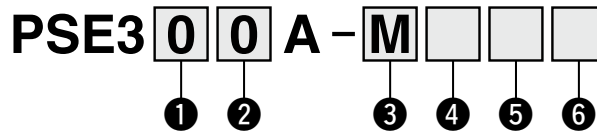

1 Input specification

Symbol	Description
0	Voltage input
1	Current input

2 Output specification

Symbol	Description	Factory default settings
0	NPN/PNP open collector 2 outputs switching type + Analog voltage/Auto-shift/Copy function switching type	NPN open collector 2 outputs + Analog voltage*1
3	NPN/PNP open collector 2 outputs switching type + Analog voltage/Auto-shift/Copy function switching type	PNP open collector 2 outputs + Analog voltage*1
1	NPN/PNP open collector 2 outputs switching type + Analog current/Auto-shift/Copy function switching type	NPN open collector 2 outputs + Analog current*2
4	NPN/PNP open collector 2 outputs switching type + Analog current/Auto-shift/Copy function switching type	PNP open collector 2 outputs + Analog current*2
6	NPN/PNP open collector 2 outputs switching type + Copy function	NPN open collector 2 outputs + Copy function

*1, 2 Although the default output specifications differ, the output specifications are the same.

3 Unit specification

Symbol	Description
Nil	With unit selection function*1
M	SI units only*2

*1 Under the New Measurement Act, switches with the unit selection function are no longer allowed for use in Japan.

*2 Fixed unit: MPa, kPa, Pa

4 Option 1

Symbol	Description
Nil	Without lead wire
L	Lead wire with connector (2 m lead wire)

ZS-46-5L

Power supply/output lead wire with connector

6 Option 3

Symbol	Description
Nil	None
C	Sensor connector

ZS-28-C

Sensor connector

* This connector cannot be used with the PSE570 series.

5 Option 2

Symbol	Description
Nil	None
A	Bracket
B	Panel mount adapter
D	Panel mount adapter + Front protection cover

ZS-46-A1

Panel mount adapter

ZS-46-D

Panel mount adapter

Options/Part Nos.

When only optional parts are required, order with the part numbers listed below.

Description	Part no.	Note
Bracket	ZS-46-A1	—
Panel mount adapter	ZS-46-B	—
Panel mount adapter + Front protection cover	ZS-46-D	—
Lead wire with connector	ZS-46-5L	5-core, 2 m
Front protection cover	ZS-27-01	—
Sensor connector (1 pc. per set)	ZS-28-C	For the PSE5□□ series (Excludes the PSE570 series)
	ZS-28-CA-4	For PSE570 series

PSE300A Series

For pressure switch precautions and specific product precautions, refer to the "Operation Manual" on the SMC website. Click [here](#) for details.

Specifications

Series		PSE300A									
Applicable SMC pressure sensor		PSE550	PSE531 PSE541 PSE561	PSE533 PSE543 PSE563 PSE573	PSE532	PSE564 PSE574	PSE530 PSE540 PSE560 PSE570	PSE575	PSE576	PSE577	
Rated pressure range		0 to 2 kPa	0 to -101 kPa	-100 to 100 kPa	0 to 100 kPa	0 to 500 kPa	0 to 1 MPa	0 to 2 MPa	0 to 5 MPa	0 to 10 MPa	
Display/Set pressure range		-0.2 to 2.1 kPa	10 to -105 kPa	-105 to 105 kPa	-10 to 105 kPa	-50 to 525 kPa	-0.105 to 1.05 MPa	-0.105 to 2.1 MPa	-0.25 to 5.25 MPa	-0.50 to 10.5 MPa	
Display/Smallest settable increment		0.001 kPa	0.1 kPa	0.1 kPa	0.1 kPa	1 kPa	0.001 MPa	0.001 MPa	0.01 MPa	0.01 MPa	
Electrical	Power supply voltage	12 to 24 VDC $\pm 10\%$, Ripple (p-p) 10% or less									
	Current consumption	35 mA or less									
	Protection	Polarity protection									
Accuracy	Display accuracy	$\pm 0.5\%$ F.S. ± 1 digit (Ambient temperature of 25°C)									
	Repeatability	$\pm 0.1\%$ F.S. ± 1 digit									
	Analog output accuracy (To display value)	$\pm 0.5\%$ F.S.									
	Analog output linearity	$\pm 0.2\%$ F.S.									
	Temperature characteristics	$\pm 0.5\%$ F.S. (Reference: 25°C)									
Switch output	Output type	Select from NPN or PNP open collector 2 outputs.									
	Output mode	Select from Hysteresis, Window comparator, Error output, or Switch output OFF modes.									
	Switch operation	Select from Normal or Reversed output.									
	Max. load current	80 mA									
	Max. applied voltage (NPN only)	30 VDC									
	Internal voltage drop (Residual voltage)	NPN: 1 V or less (at load current of 80 mA) PNP: 1.5 V or less (at load current of 80 mA)									
	Delay time*1	1.5 ms or less (with anti-chattering function: 20, 100, 500, 1000, 2000, 5000 ms)									
	Hysteresis	Hysteresis mode	Variable from 0*2								
		Window comparator mode									
	Protection	Over current protection									
Analog output	Voltage output	Output type*3	Voltage output: 1 to 5 V Extension analog output range: 0.6 to 1 V								
		Output impedance	Approx. 1 k Ω								
	Current output	Output type*3	Current output: 4 to 20 mA Extension analog output range: 2.4 to 4 mA								
		Load impedance	Maximum load impedance at power supply voltage of 12 V: 300 Ω at power supply voltage of 24 V: 600 Ω Minimum load impedance: 50 Ω								
Analog response time		50 ms or less									
Auto-shift input	Input type	Non-voltage input: 0.4 V or less									
	Input mode	Select from Auto-shift or Auto-shift zero.									
	Input time	5 ms or more									
Sensor input	Input type	PSE30□A: Voltage input 1 to 5 VDC (Input impedance: 1 M Ω) PSE31□A: Current input 4 to 20 mA DC (Input impedance: 51 Ω)									
	Number of inputs	1 input									
	Connection method	Connector (e-CON)									
	Protection	Over voltage protection (up to a voltage of 26.4 V)									
Display	Unit*4	MPa, kPa, Pa, kgf/cm ² , bar, mbar, psi, inHg, mmHg, mmH ₂ O									
	Display type	LCD									
	Number of screens	3-screen display (Main screen, Sub screen x 2)									
	Display color	1) Main screen: Red/Green 2) Sub screen: Orange									
	Number of display digits	1) Main screen: 4 digits (7 segments) 2) Sub screen: 4 digits (Upper 1 digit 11 segments, 7 segments for other)									
	Indicator light	Lights up when switch output is turned ON. OUT1, OUT2: Orange									
	Digital filter*5,*6		0, 10, 50, 100, 500, 1000, 5000 ms								
Environment	Enclosure	IP40									
	Withstand voltage	1000 VAC for 1 minute between terminals and housing									
	Insulation resistance	50 M Ω or more (500 VDC measured via megohmmeter) between terminals and housing									
	Operating temperature range	Operating: 0 to 50°C, Stored: -10 to 60°C (No freezing or condensation)									
	Operating humidity range	Operating/Stored: 35 to 85% RH (No condensation)									
Standards		UL/CSA (E216656), CE/UKCA marking									
Weight	Body	25 g (Excludes power supply and output lead wires)									
	Lead wire with connector	+39 g									

*1 Value without digital filter (at 0 ms)

*2 If the sensor input fluctuates around the set value, the hysteresis must be set to a value more than the amount of fluctuation, or chattering will occur.

*3 If the connected sensor does not have an extended analog output range, there is no extended analog output range available for this product.

*4 This setting is only possible for models with the unit selection function. Only MPa, kPa, or Pa is available for models without this function (set by pressure range).

*5 The response time indicates when the set value is 90% in relation to the step input.

*6 Display, switch output and analog response time are affected.

* Products with tiny scratches, marks, or display color or brightness variations which do not affect the performance of the product are verified as conforming products.

Internal Circuits and Wiring Examples

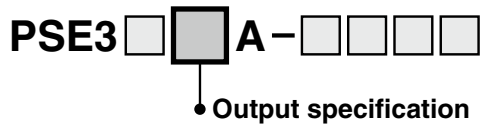

Output specification	Settable circuit	Factory default settings
0	①, ②, ③, ④, ⑤, ⑥	③
1	①, ②, ③, ④, ⑤, ⑥	③
3	①, ②, ③, ④, ⑤, ⑥	④
4	①, ②, ③, ④, ⑤, ⑥	④
6	①, ②	①

① **NPN (2 outputs) + Copy function setting**

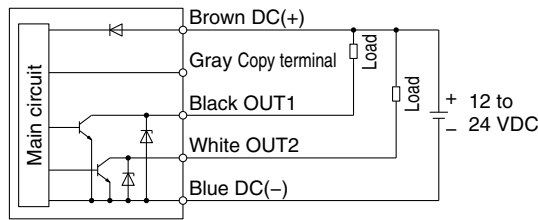

② **PNP (2 outputs) + Copy function setting**

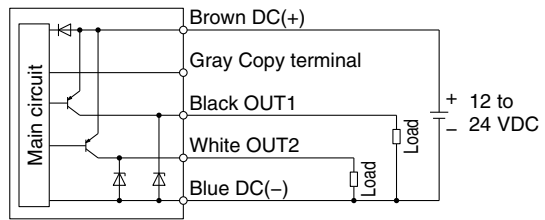

③ **NPN (2 outputs) + Analog voltage output setting**
NPN (2 outputs) + Analog current output setting

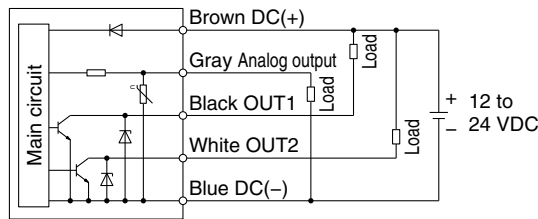

④ **PNP (2 outputs) + Analog voltage output setting**
PNP (2 outputs) + Analog current output setting

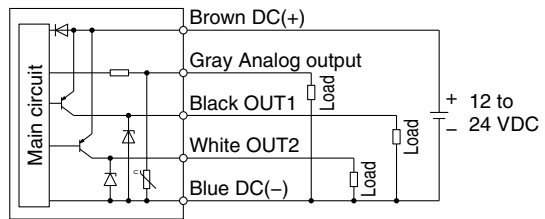

⑤ **NPN (2 outputs) + Auto-shift setting**

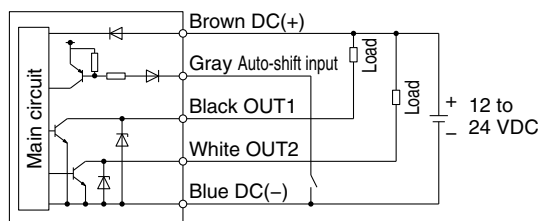

⑥ **PNP (2 outputs) + Auto-shift setting**

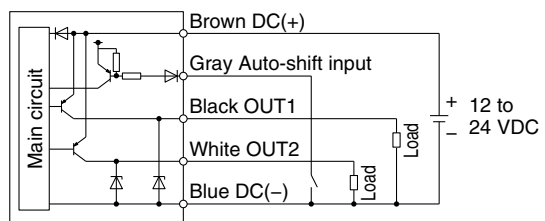

Sensor connector connection

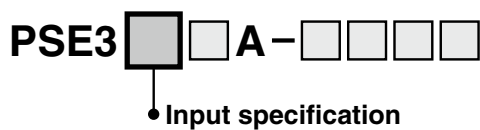

Pin no.	Terminal		
	PSE30 A (Voltage input)	PSE31 A (Current input)	
		Pressure sensor 2-wire type	Pressure sensor 3-wire type
1	DC (+)(Brown)	DC (-)(Brown)	DC (+)(Brown)
2	N.C.	N.C.	N.C.
3	DC (-)(Blue)	N.C.	DC (-)(Blue)
4	IN (1 to 5 V)(Black)	IN (4 to 20 mA)(Blue)	IN (4 to 20 mA)(Black)

* The colors in () indicate the wire color of the PSE5 series.

PSE300A Series

Dimensions

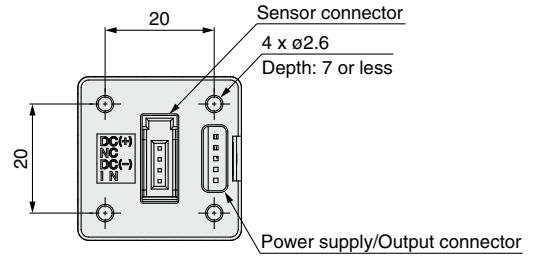
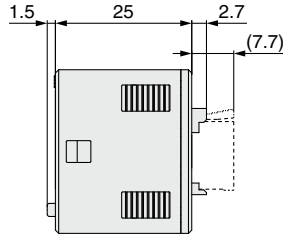
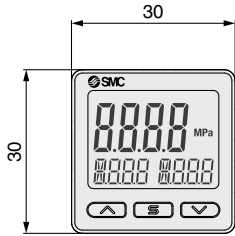
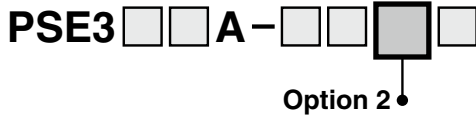

A

Bracket
(Part no.: ZS-46-A1)

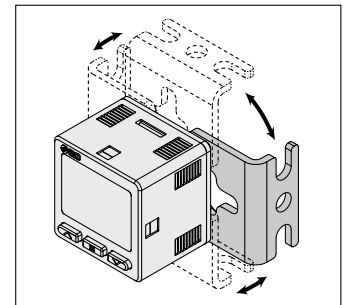
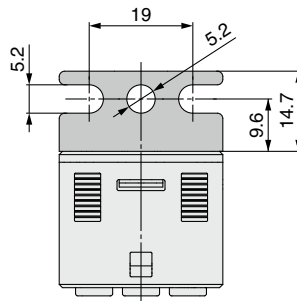
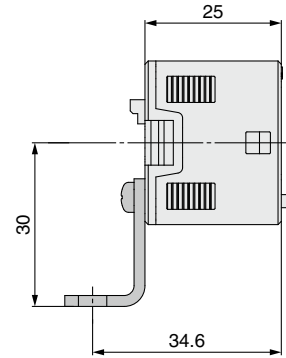
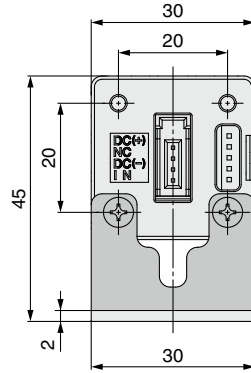

* The bracket configuration allows for mounting in four orientations.

B

Panel mount adapter
(Part no.: ZS-46-B)

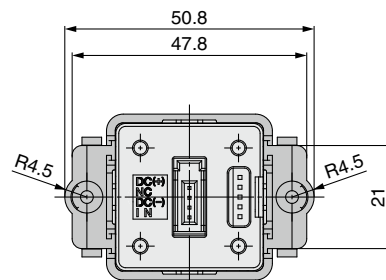
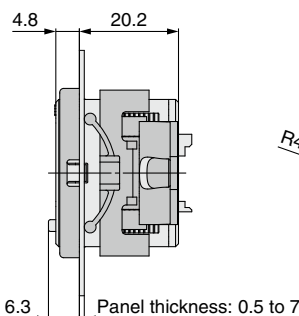
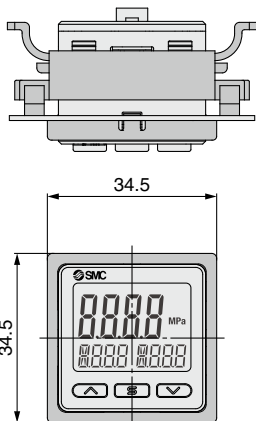

Dimensions

D

Panel mount adapter + Front protection cover
(Part no.: ZS-46-D)

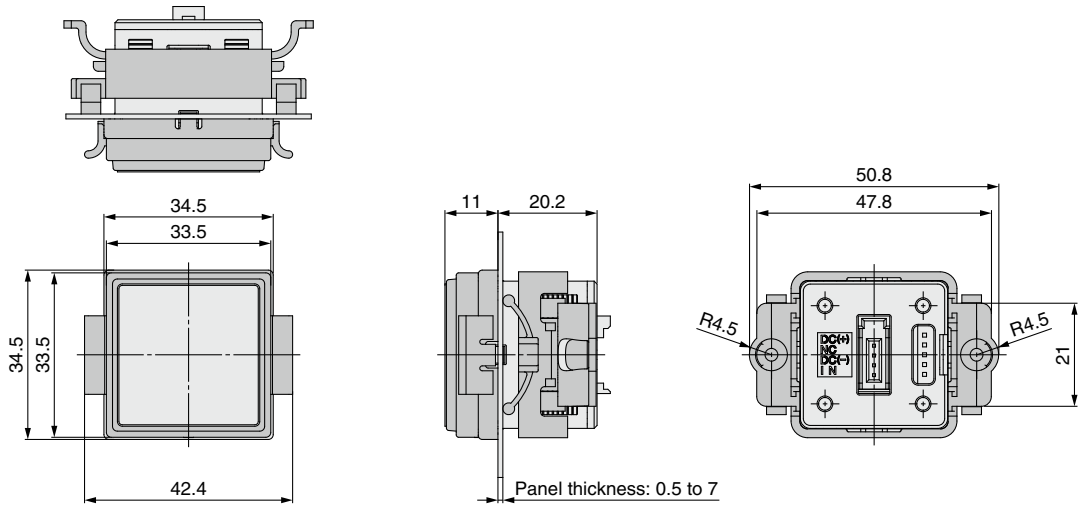

Lead wire with connector
(Part no.: ZS-46-5L)

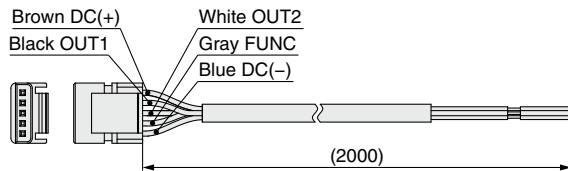

Cable Specifications

Conductor area		0.15 mm ² (AWG26)
Insulator	O.D.	1.0 mm
	Color	Brown, Blue, Black, White, Gray (5-core)
Sheath	Finished O.D.	ø3.5

PSE300A Series

Dimensions

Panel fitting dimensions

Individual mounting

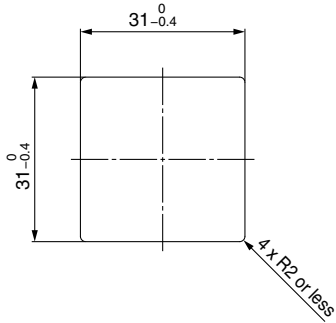

Multiple (2 pcs. or more) secure mounting <Horizontal>

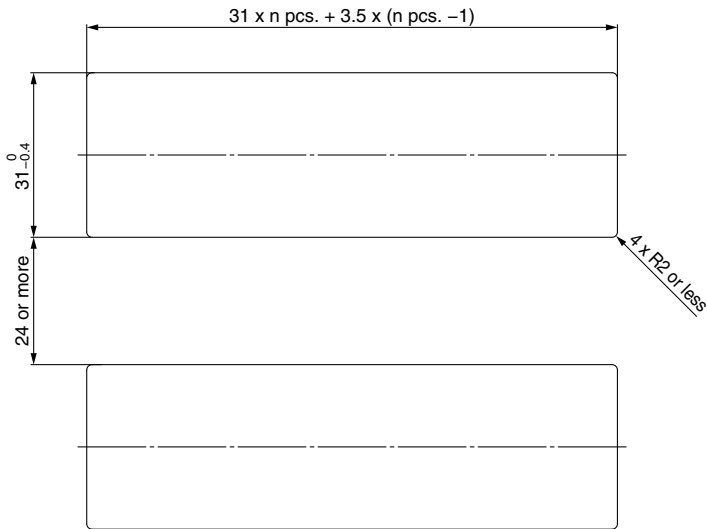

Panel mount example <Horizontal>

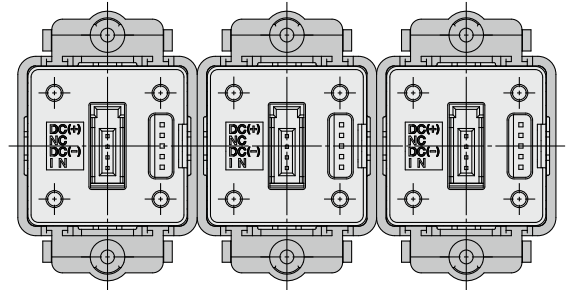

<Vertical>

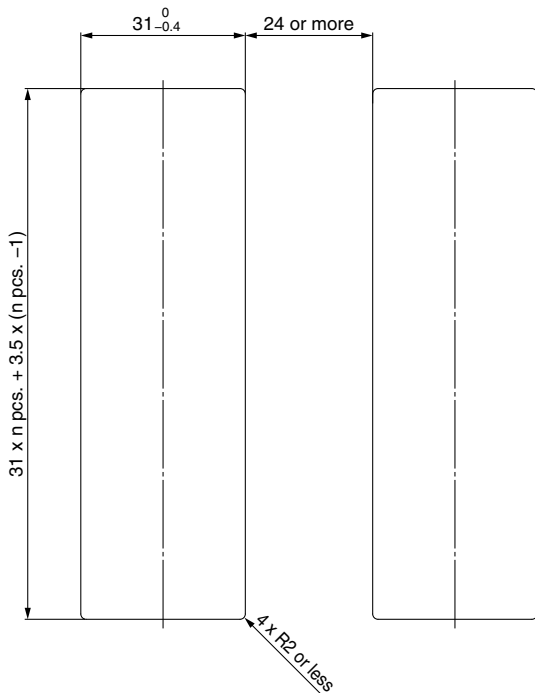

Panel mount example <Vertical>

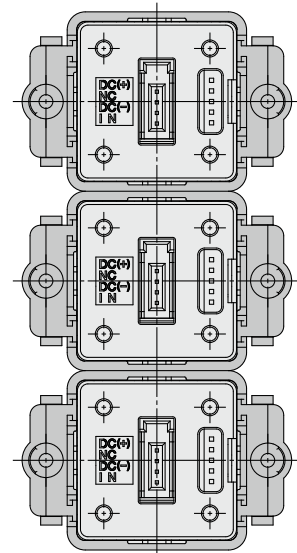

PSE300A Series

Function Details

Display examples of the main and sub (set value) screens of each mode.

Hysteresis mode, Normal output

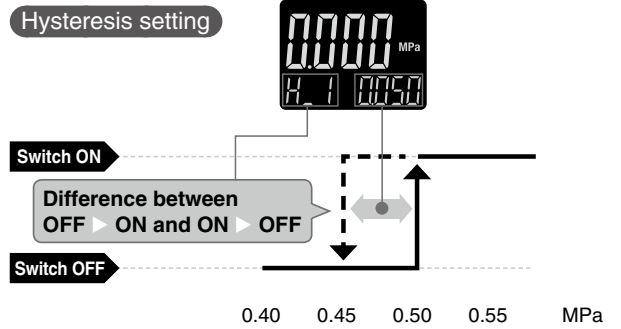
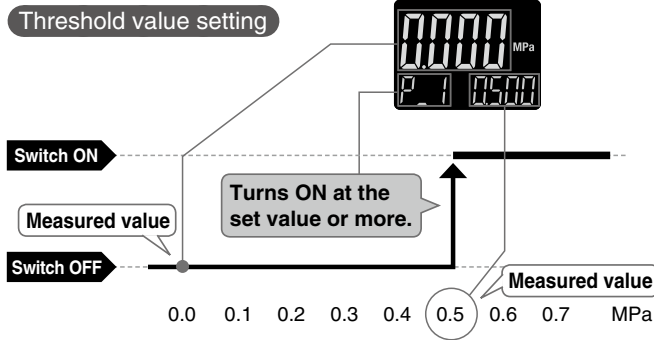

Hysteresis mode, Reversed output

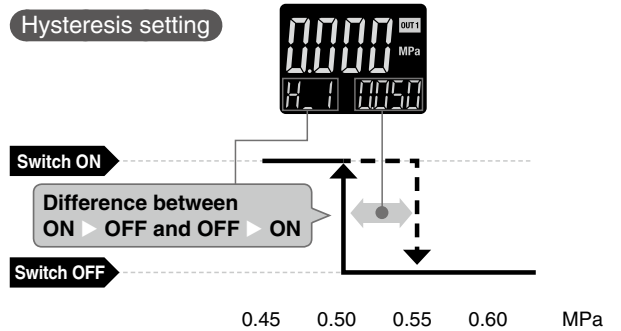
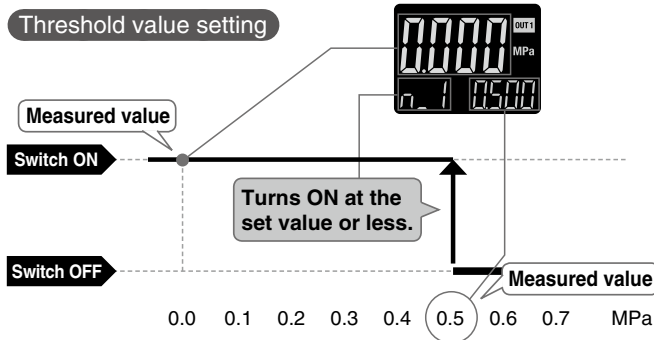

Window comparator mode, Normal output

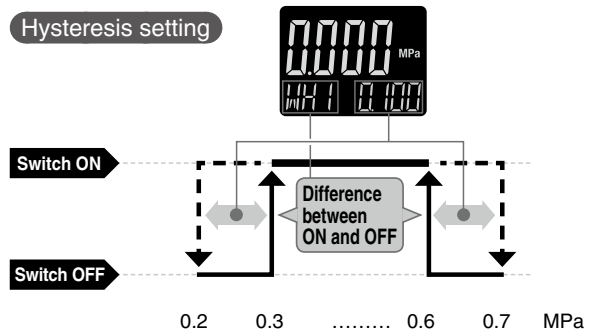
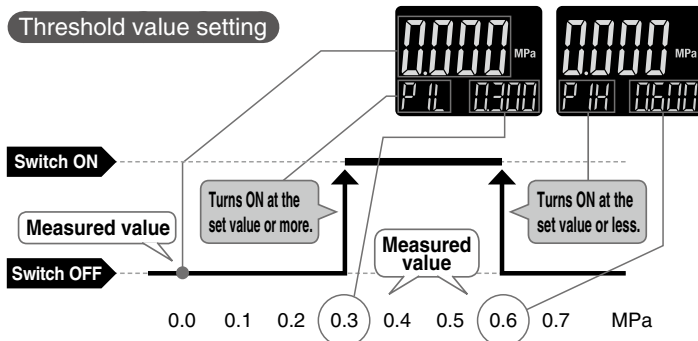

Window comparator mode, Reversed output

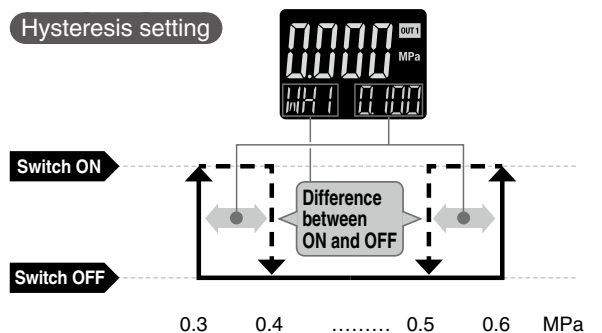
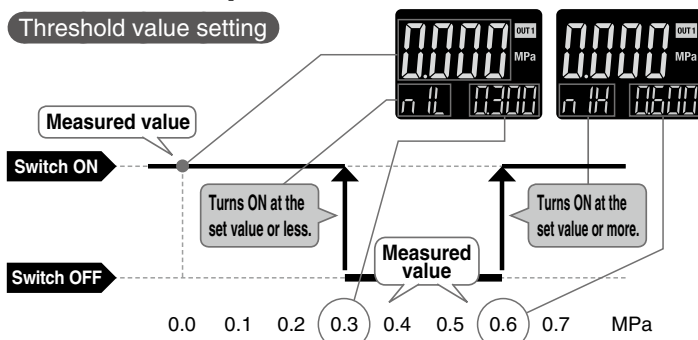

The F□ in () shows the function code number. Refer to the operation manual for details on operation procedures and function codes. Click [here](#) for details.

Function Details

A Auto-preset function (F4)

This function, when selected in the initial setting, calculates and stores the set value from the measured pressure. For example, if this function is used for suction verification, the optimum set value is determined automatically by repeating vacuum and break with the target workpiece several times.

Suction Verification

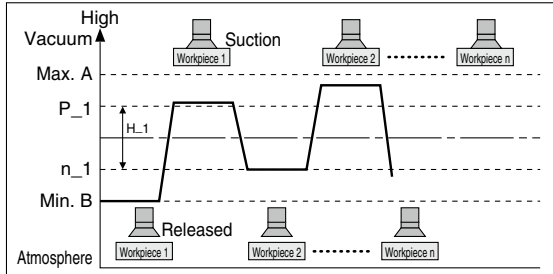

Formula for Obtaining the Set Value

P_1 or P_2	H_1 or H_2
$P_1(P_2)=A-(A-B)/4$	$H_1(H_2)= (A-B)/2 $
$n_1(n_2)=B+(A-B)/4$	

B Display value fine adjustment function (F6)

Fine adjustment of the indicated value of the pressure sensor can be made within the range of $\pm 5\%$ of the read value. (This eliminates wide variations of the indicated value.)

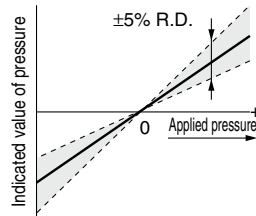

— Indicated value at the time of shipment
 - - - Adjustable range of display value fine adjustment function

* When the display value fine adjustment function is used, the set pressure value may change ± 1 digit.

C Peak/Bottom value indication function

This function constantly detects and updates the maximum (minimum) pressure when the power is supplied, and allows to hold the maximum (minimum) pressure value.

The held value is maintained even if the power supply is cut.

When the and buttons are simultaneously pressed for 1 second or longer, while "holding", the held value will be reset.

D Key-lock function

This function prevents operation errors such as accidentally changing setting values.

E Zero-clear function

This function clears and resets the zero value on the display of measured pressure. The indicated value can be adjusted within $\pm 7\%$ F.S. of the pressure at the time of factory shipment. ($\pm 3.5\%$ F.S. for compound pressure)

F Error display function

This function displays error location and content when a problem or error has occurred.

Error name	Error code	Description	Action
Over current error		Load current of 80 mA or more is applied to the switch output.	Turn the power off and remove the cause of the over current. Then supply the power again.
Residual pressure error		During zero-clear operation, pressure over $\pm 7\%$ F.S. ($\pm 3.5\%$ F.S. for compound pressure) is present. Note that the mode is returned to measurement mode automatically 1 second later. The zero-clear range varies by $\pm 1\%$ F.S. due to variation between individual products.	Perform zero-clear operation again after restoring the applied pressure to an atmospheric pressure condition.
Applied pressure error		Supply pressure exceeds the maximum set pressure.	Reset applied pressure to a level within the set pressure range. Check the sensor connection.
		Supply pressure is below the minimum set pressure. A sensor may be disconnected or mis-wired.	
System error	 	Internal data error	Turn the power off and then on again. If the failure cannot be solved, please contact SMC for investigation.
Copy error		The copy function does not operate properly.	After clearing the error by pressing the and buttons simultaneously for a minimum of 1 second, check the wiring and the model, and then attempt to copy again.

If the error cannot be reset after the above measures are taken, or errors other than those above are displayed, please contact SMC for investigation.

The F□ in () shows the function code number. Refer to the operation manual for details on operation procedures and function codes. Click [here](#) for details.

Function Details

G Anti-chattering function (Simple setting mode or F1)

A large bore cylinder or ejector consumes a large volume of air during operation and may experience a temporary drop in the supply pressure. This function prevents the detection of such temporary drops in the supply pressure as errors by changing the delay time setting.

Available delay time settings
1.5 ms or less, 20 ms, 100 ms, 500 ms, 1000 ms, 2000 ms, 5000 ms

<Principle>

This function averages pressure values measured during the response time set by the user and then compares the average pressure value with the pressure set point value to output the result on the switch.

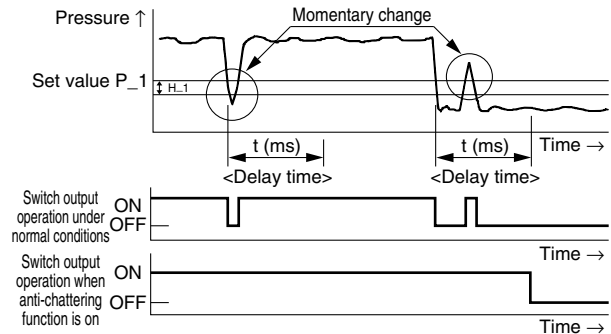

H Unit selection function (F0)

Display units can be switched with this function.

Display Smallest settable increment	Display unit	Rated pressure range	Display/ Set pressure range	MPa	kPa	Pa	kgf/cm ²	bar	mbar	psi	inHg	mmHg	mmH ₂ O
				MPa	kPa	Pa	kgf/cm ²	bar	mbar	psi	inHg	mmHg	mmH ₂ O
Applicable SMC pressure sensor	PSE550	0 to 2 kPa	-0.200 to 2.100 kPa		0.001	1			0.01	0.001			0.1
	PSE531	0 to -101 kPa	10.0 to -105.0 kPa	0.001	0.1		0.001	0.001	0.01	0.1	1		
	PSE541												
	PSE561												
	PSE561												
	PSE533	-100 to 100 kPa	-105.0 to 105.0 kPa	0.001	0.1		0.001	0.001	0.02	0.1	1		
	PSE543												
	PSE563												
	PSE573												
	PSE532	0 to 100 kPa	-10.0 to 105.0 kPa	0.001	0.1		0.001	0.001	0.01				
	PSE564	0 to 500 kPa	-50 to 525 kPa	0.001	1		0.01	0.01	0.1				
	PSE574												
	PSE530	0 to 1 MPa	-0.105 to 1.050 MPa	0.001	1		0.01	0.01	0.1				
PSE540													
PSE560													
PSE570													
PSE575	0 to 2 MPa	-0.105 to 2.100 MPa	0.001	1		0.01	0.01	0.2					
PSE576	0 to 5 MPa	-0.25 to 5.25 MPa	0.01			0.1	0.1	1					
PSE577	0 to 10 MPa	-0.50 to 10.50 MPa	0.01			0.1	0.1	1					
Additional range	—	0 to 20 MPa	-1.00 to 21.00 MPa	0.01			0.1	0.1	2				
		0 to 25 MPa	-1.26 to 26.26 MPa	0.02			0.2	0.2	2				

It varies depending on the smallest settable increment of the additional range.

I Input range selection (F0)

Display value can be set by user according to the sensor input (voltage input: 1 to 5 V, current input: 4 to 20 mA).

* The display and analog output are interlocked, so if one is changed the other will change.

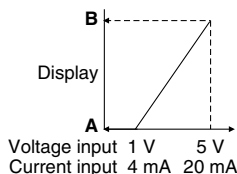

J Power-saving mode (F80)

Power-saving mode can be selected.

It shifts to power-saving mode automatically when there is no button operation for 30 seconds.

The product is set to normal mode (Power-saving mode is OFF) at the time of factory shipment.

(When in power-saving mode, [EC0] will flash in the sub screen and the operation light will be ON (only when the switch is ON).)

K Setting of security code (F81)

Users can select whether a security code must be entered to release the key lock.

At the time of factory shipment, it is set so that a security code is not required.

The F□ in () shows the function code number. Refer to the operation manual for details on operation procedures and function codes. Click [here](#) for details.

Function Details

L Copy function (F97)

The set values of the sensor can be copied. This can reduce setting labor and minimize the risk of setting mistakes.

The set value can be copied to up to 10 sensors simultaneously. (Maximum transmission distance: 4 m)

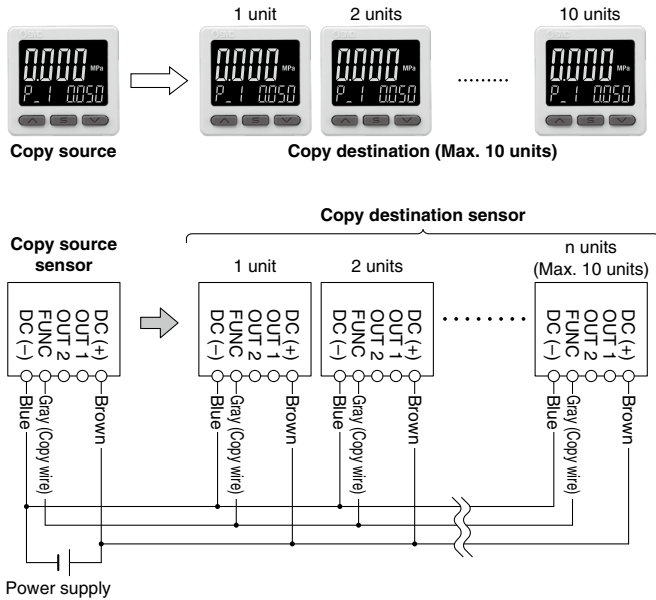

- 1) Wire as shown in the figure above.
- 2) All sensors are set to copy destination when first purchased. (Default condition is the sensor to be copied to.)
- 3) Press the **S** button on the source sensor to start copying.

N Analog free span function (F5)

For the displayed value, the analog span point (5 V, 20 mA) can be changed within the rated pressure range of 10 to 105%*1.

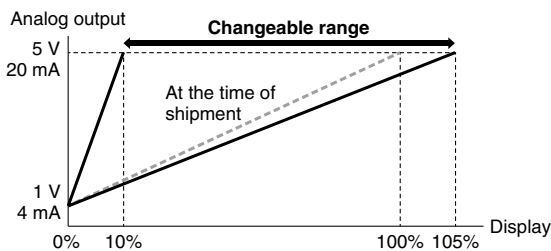

*1 Up to the upper limit of the display/set pressure range

M Auto-shift function (F5)

When there are large fluctuations in the supply pressure, the switch may fail to operate correctly.

This function compensates for such supply pressure fluctuations. It measures the pressure at the time of auto-shift signal input and uses it as the reference pressure to correct the set value on the switch.

Set value correction by auto-shift function

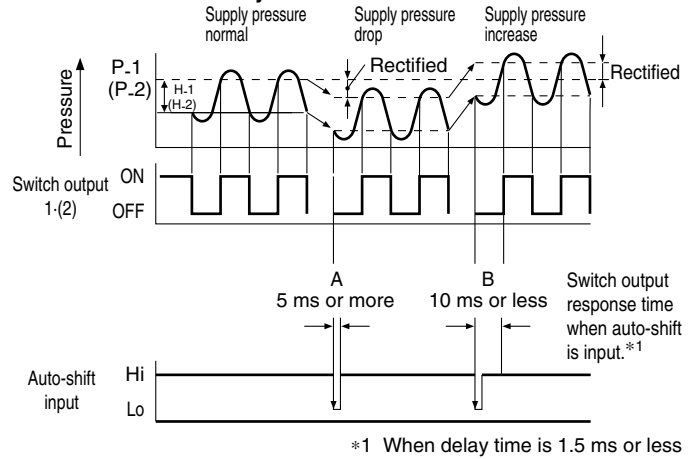

When the auto-shift function is selected, "P5 in 000" will be displayed on the sub screen for about 1 second, and the pressure value at that point will be saved as reference value "r_5". Based on the saved reference value, output on-off points controlled by set values*2 such as "P_1", "H_1", "P_2", and "H_2" will also be rectified.

*2 When an output is reversed, output on-off points displayed at "n_1", "H_1", "n_2", and "H_2" will be rectified.

The above is an example in hysteresis mode. On-off points are similarly rectified in window comparator mode. Outputs that enable the auto-shift function can be changed via the settings.

Settable Range for Auto-Shift Input

Range settings	Settable range
0 to 2 kPa	-2.30 to 2.300 kPa
0 to -101 kPa	115.0 to -115.0 kPa
-100 to 100 kPa	-210 to 210.0 kPa
0 to 100 kPa	-115.0 to 115.0 kPa
0 to 500 kPa	-575 to 575 kPa
0 to 1 MPa	-1.155 to 1.155 MPa
0 to 2 MPa	-2.20 to 2.205 MPa
0 to 5 MPa	-5.50 to 5.50 MPa
0 to 10 MPa	-11.00 to 11.00 MPa
0 to 20 MPa	-22.0 to 22.00 MPa
0 to 25 MPa	-27.5 to 27.52 MPa

Auto-shift zero

The basic function of auto-shift zero is the same as that of auto-shift. However, it corrects values on the display based on a pressure value of "0", which is set as the reference value when auto-shift function is selected.

Safety Instructions

These safety instructions are intended to prevent hazardous situations and/or equipment damage. These instructions indicate the level of potential hazard with the labels of “**Caution**,” “**Warning**” or “**Danger**.” They are all important notes for safety and must be followed in addition to International Standards (ISO/IEC)*1), and other safety regulations.

 **Caution:** **Caution** indicates a hazard with a low level of risk which, if not avoided, could result in minor or moderate injury.

 **Warning:** **Warning** indicates a hazard with a medium level of risk which, if not avoided, could result in death or serious injury.

 **Danger:** **Danger** indicates a hazard with a high level of risk which, if not avoided, will result in death or serious injury.

*1) ISO 4414: Pneumatic fluid power – General rules relating to systems.
ISO 4413: Hydraulic fluid power – General rules relating to systems.
IEC 60204-1: Safety of machinery – Electrical equipment of machines.
(Part 1: General requirements)
ISO 10218-1: Manipulating industrial robots – Safety.
etc.

Warning

1. The compatibility of the product is the responsibility of the person who designs the equipment or decides its specifications.

Since the product specified here is used under various operating conditions, its compatibility with specific equipment must be decided by the person who designs the equipment or decides its specifications based on necessary analysis and test results. The expected performance and safety assurance of the equipment will be the responsibility of the person who has determined its compatibility with the product. This person should also continuously review all specifications of the product referring to its latest catalog information, with a view to giving due consideration to any possibility of equipment failure when configuring the equipment.

2. Only personnel with appropriate training should operate machinery and equipment.

The product specified here may become unsafe if handled incorrectly. The assembly, operation and maintenance of machines or equipment including our products must be performed by an operator who is appropriately trained and experienced.

3. Do not service or attempt to remove product and machinery/equipment until safety is confirmed.

1. The inspection and maintenance of machinery/equipment should only be performed after measures to prevent falling or runaway of the driven objects have been confirmed.
2. When the product is to be removed, confirm that the safety measures as mentioned above are implemented and the power from any appropriate source is cut, and read and understand the specific product precautions of all relevant products carefully.
3. Before machinery/equipment is restarted, take measures to prevent unexpected operation and malfunction.

4. Contact SMC beforehand and take special consideration of safety measures if the product is to be used in any of the following conditions.

1. Conditions and environments outside of the given specifications, or use outdoors or in a place exposed to direct sunlight.
2. Installation on equipment in conjunction with atomic energy, railways, air navigation, space, shipping, vehicles, military, medical treatment, combustion and recreation, or equipment in contact with food and beverages, emergency stop circuits, clutch and brake circuits in press applications, safety equipment or other applications unsuitable for the standard specifications described in the product catalog.
3. An application which could have negative effects on people, property, or animals requiring special safety analysis.
4. Use in an interlock circuit, which requires the provision of double interlock for possible failure by using a mechanical protective function, and periodical checks to confirm proper operation.

Caution

1. The product is provided for use in manufacturing industries.

The product herein described is basically provided for peaceful use in manufacturing industries.
If considering using the product in other industries, consult SMC beforehand and exchange specifications or a contract if necessary.
If anything is unclear, contact your nearest sales branch.

Limited warranty and Disclaimer/ Compliance Requirements

The product used is subject to the following “Limited warranty and Disclaimer” and “Compliance Requirements”.

Read and accept them before using the product.

Limited warranty and Disclaimer

1. The warranty period of the product is 1 year in service or 1.5 years after the product is delivered, whichever is first.*2)
Also, the product may have specified durability, running distance or replacement parts. Please consult your nearest sales branch.
2. For any failure or damage reported within the warranty period which is clearly our responsibility, a replacement product or necessary parts will be provided.
This limited warranty applies only to our product independently, and not to any other damage incurred due to the failure of the product.
3. Prior to using SMC products, please read and understand the warranty terms and disclaimers noted in the specified catalog for the particular products.

*2) Vacuum pads are excluded from this 1 year warranty.

A vacuum pad is a consumable part, so it is warranted for a year after it is delivered.
Also, even within the warranty period, the wear of a product due to the use of the vacuum pad or failure due to the deterioration of rubber material are not covered by the limited warranty.

Compliance Requirements

1. The use of SMC products with production equipment for the manufacture of weapons of mass destruction (WMD) or any other weapon is strictly prohibited.
2. The exports of SMC products or technology from one country to another are governed by the relevant security laws and regulations of the countries involved in the transaction. Prior to the shipment of a SMC product to another country, assure that all local rules governing that export are known and followed.

Caution

SMC products are not intended for use as instruments for legal metrology.

Measurement instruments that SMC manufactures or sells have not been qualified by type approval tests relevant to the metrology (measurement) laws of each country. Therefore, SMC products cannot be used for business or certification ordained by the metrology (measurement) laws of each country.

Safety Instructions

Be sure to read the “Handling Precautions for SMC Products” (M-E03-3) and “Operation Manual” before use.