

# Flow Controller for Air

New

Applicable fluid **Dry air, N<sub>2</sub>, Ar, CO<sub>2</sub>**

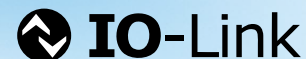

## For the automatic adjustment of the flow rate

### Flow ratio 100:1

\* Maximum rating control flow rate value: minimum rating control flow rate value.

Series	Port size	Flow range [L/min]								Set-up setting control flow rate minimum unit [L/min]	
		0.1	0.2	0.5	1	2	10	25	50		100
PFCA710	C4, C6, (Rc, NPT, G) 1/8	0.1		10							0.01
PFCA725	C6, C8, N7, (Rc, NPT, G) 1/8	0.2		25							0.1
PFCA750		0.5		50							
PFCA711	C6, C8, N7, (Rc, NPT, G) 1/4	1		100							

### Color display/2-screen display supported

For the confirmation of the instantaneous flow rate, flow rate command value, and accumulated flow rate at a glance

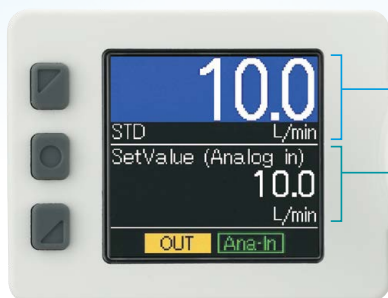

**Main screen**  
Instantaneous flow

**Sub screen**  
Flow rate command value, accumulated flow rate, etc.

**Size**  
1.44 inch

**Resolution/Color**  
128 x 128/RGB

### IO-Link Compatible

With the process data, the flow rate value and equipment status can be easily grasped, and flow rate control is also possible.

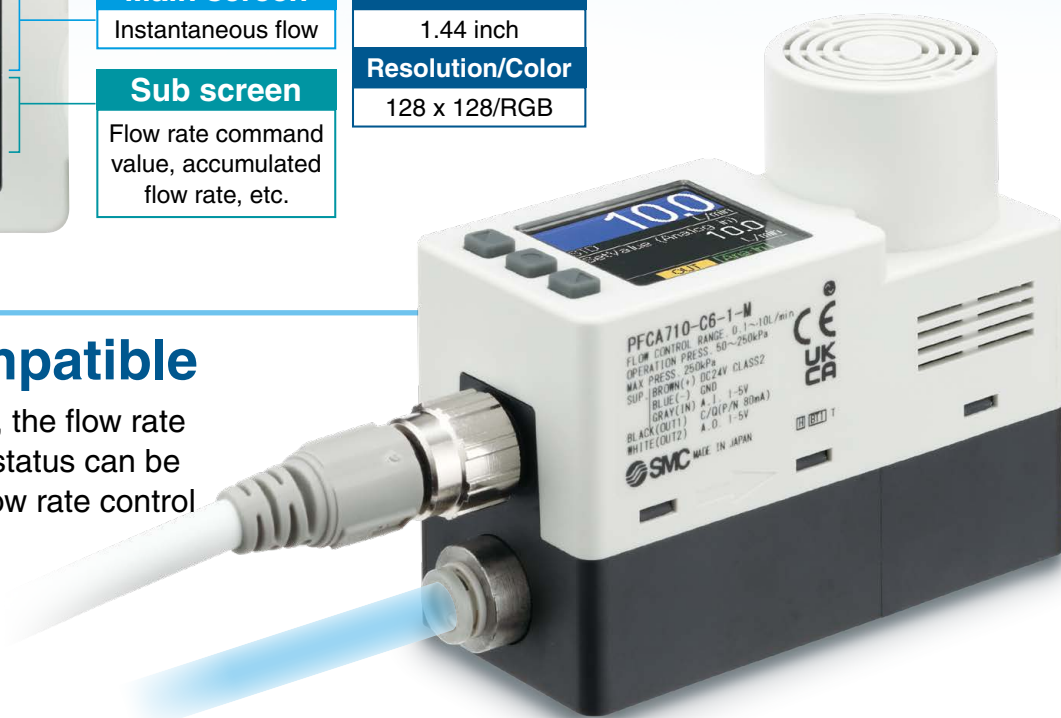

**PFCA7 Series**



CAT.ES100-162A

# Space saving/Reduced piping, wiring, and installation labor

## Automatic control to set flow rate

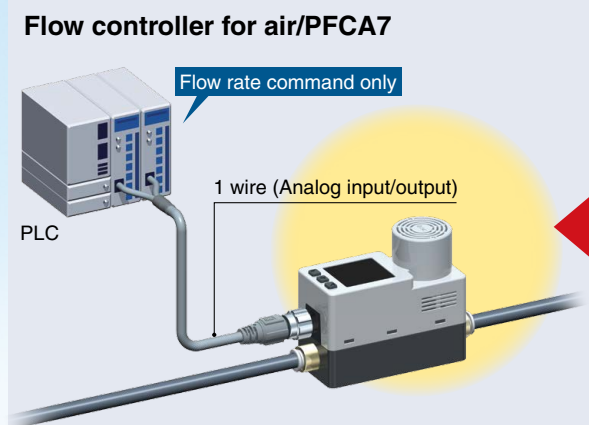

## Flow rate control program required

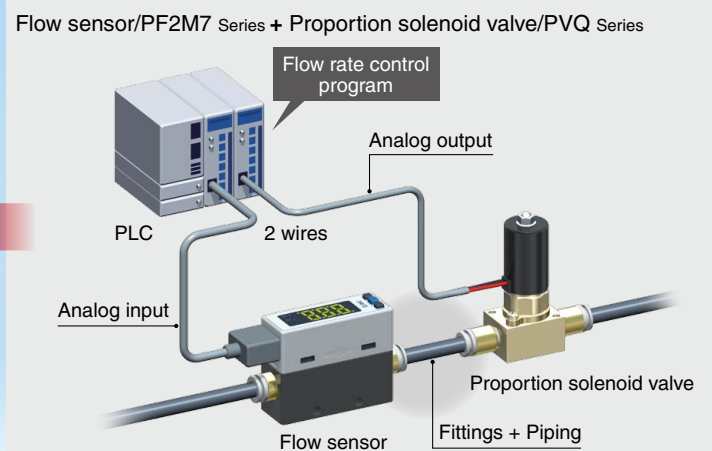

## Reduced installation labor

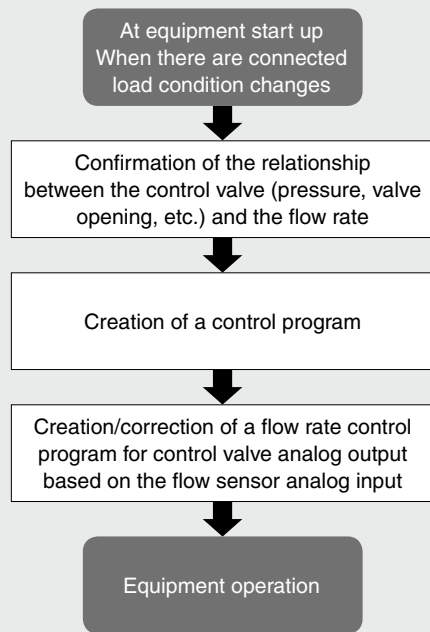
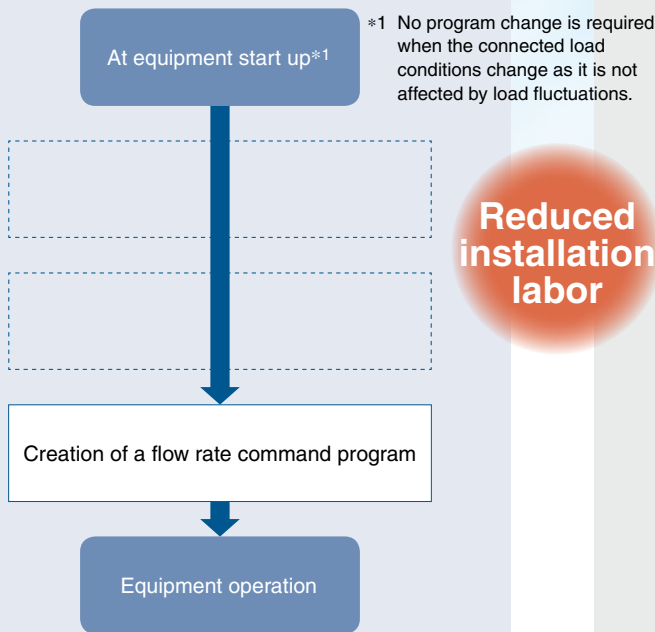

## Color display/2-screen display supported

The color display allows for improved visibility. And the 2-screen display allows you to check the status at a glance.

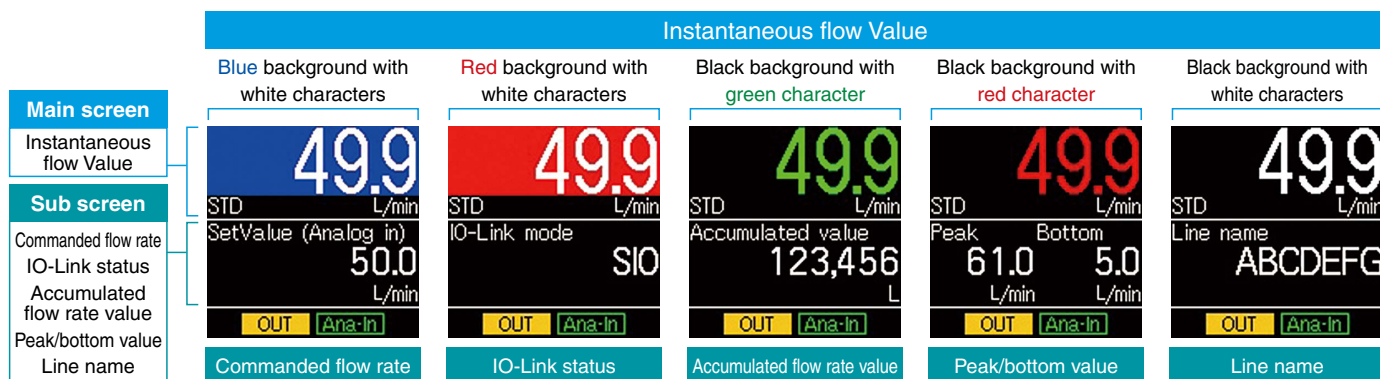

## Improved visibility and operability

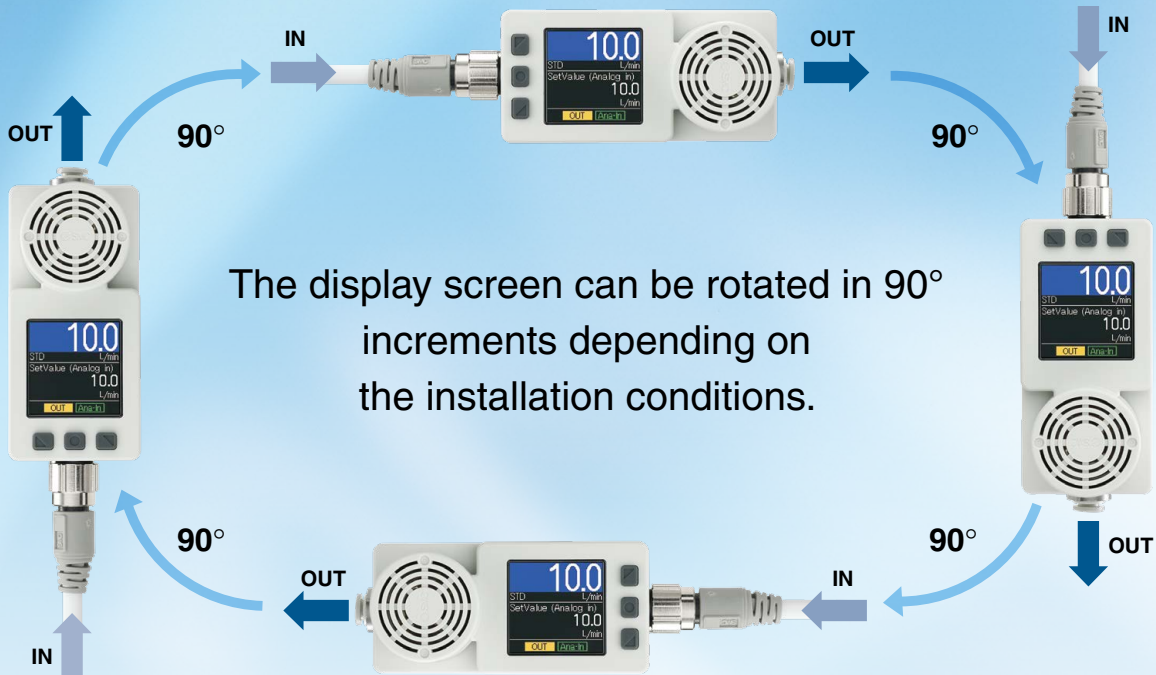

The display screen can be rotated in 90° increments depending on the installation conditions.

- The fluid can be switched.



- Control accuracy  $\pm 3\%$  F.S.

\* For dry air

- Repeatability  $\pm 1\%$  F.S.

- Responsiveness (settling time) 0.5 s or less

\* For the 10/25 L range

- Grease-free

- Improved water and foreign matter resistance due to diversion structure

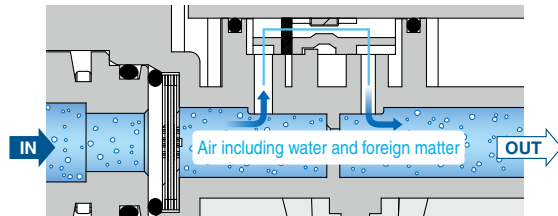

- Piping variations



### Recommended Pneumatic Circuit

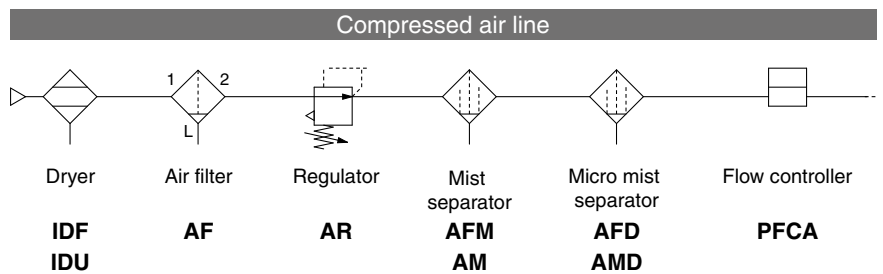

\* Recommended air quality class: JIS B 8392-1:2012 [1:6:2], ISO 8573-1:2010 [1:6:2]

### Functions

- |  |   |  |   |
|--|---|--|---|
| <ul style="list-style-type: none"> <li>• Output operation</li> <li>• Display colour</li> <li>• Reference condition</li> <li>• Selectable analog output function</li> </ul> | <ul style="list-style-type: none"> <li>• Forced output function</li> <li>• Accumulation value. hold function</li> <li>• Accumulation automatic shut off</li> <li>• Peak/Bottom value display</li> </ul> | <ul style="list-style-type: none"> <li>• Setting of a security code</li> <li>• Key-lock function</li> <li>• Reset to the default settings</li> <li>• Indication rotation function</li> <li>• Delay time setting</li> </ul> | <ul style="list-style-type: none"> <li>• Zero-clear</li> <li>• Selection of the display on the sub screen</li> <li>• Analog output free range</li> <li>• Error indication function</li> </ul> |
|--|---|--|---|

## Select a flow controller to increase energy savings!

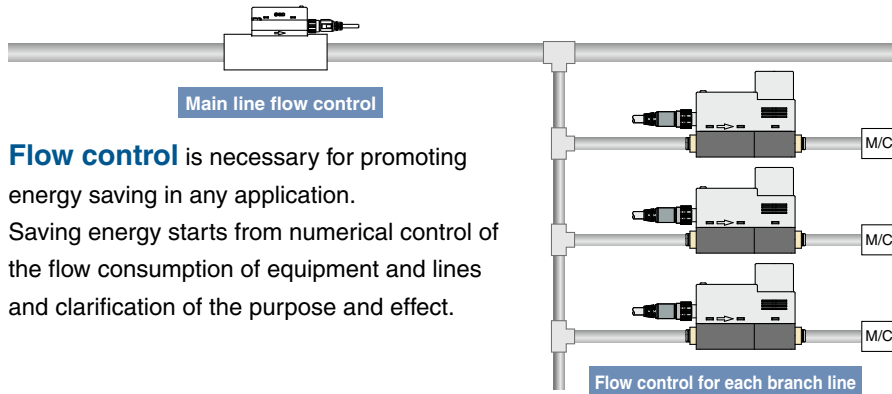

**Flow control** is necessary for promoting energy saving in any application. Saving energy starts from numerical control of the flow consumption of equipment and lines and clarification of the purpose and effect.

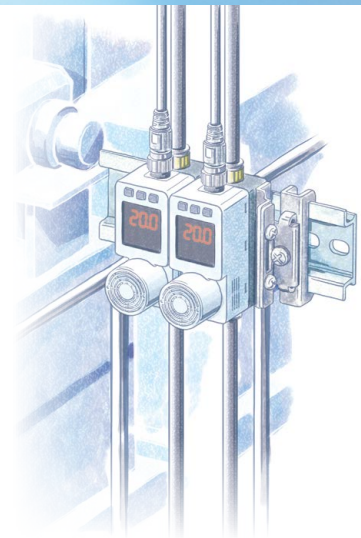

## Applications

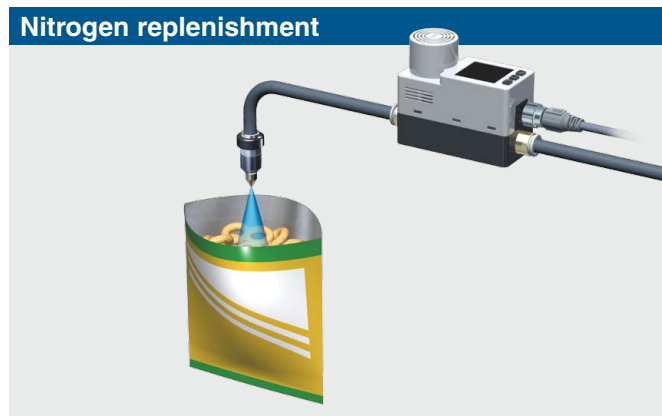
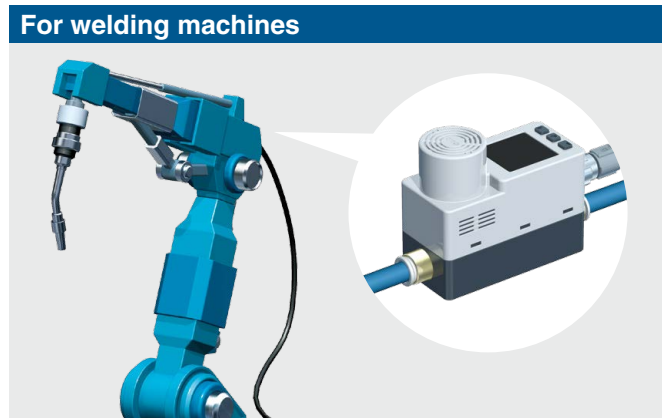
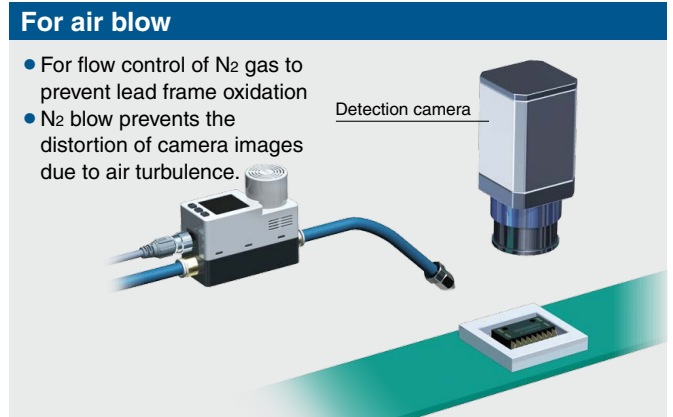
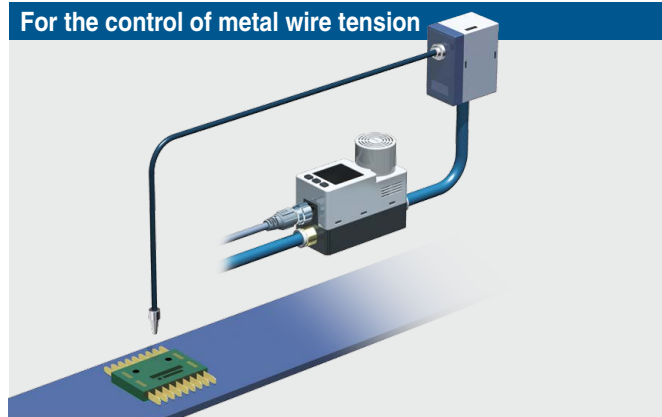

IO-Link Compatible PFCA7□-□-□□-□□□

Supports the IO-Link communication protocol



IO-Link is an open communication interface technology between the sensor/ actuator and the I/O terminal that is an international standard, IEC61131-9

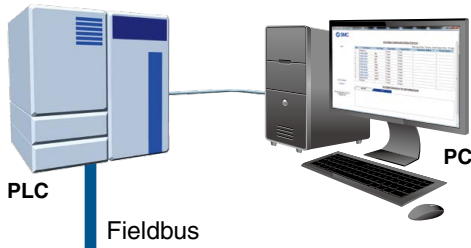

**Configuration File (IODD File\*1)**  
Manufacturer/Product part no./Set value

\*1 IODD File  
IODD is an abbreviation of IO Device Description. This file is necessary for setting the device and connecting it to a master. Save the IODD file on the PC to be used to set the device prior to use.

Device settings can be set by the master.

- Threshold value
- Operation mode, etc.
- Commanded flow rate

Read the device data.

- Switch ON/OFF signal and analog value
- Device information: Manufacturer, Product part number, Serial number, etc.
- Normal or abnormal device status
- Cable breakage

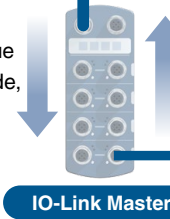

IO-Link Compatible Device: Digital Flow Switch

For the confirmation of the status via the input process data  
For the input of the flow rate command value via the output process data

Input process data

Bit offset	63	62	61	60	59	58	57	56	55	54	53	52	51	50	49	48
Item	Accumulated measurement value [upper byte] (PD)															

Bit offset	47	46	45	44	43	42	41	40	39	38	37	36	35	34	33	32
Item	Accumulated measurement value [lower byte] (PD)															

Bit offset	31	30	29	28	27	26	25	24	23	22	21	20	19	18	17	16
Item	Flow rate measurement (PD)/Measured value of the flow meter															

Bit offset	15	14	13	12	11	10	9	8	7	6	5	4	3	2	1	0
Item	System error	Error	Fixed output	Local input	Accumulation shut-off	Output PD diagnosis	Flow rate diagnostics	Accumulation diagnosis	Reference condition	Flow rate units	Reservation				Limit deviation tolerance SW	Accumulated flow SW

Bit offset	Item	Remarks
0	Accumulated flow SW	0: OFF 1: ON
1	Limit deviation tolerance SW	0: OFF 1: ON
6	Flow rate units	0: L 1: ft³
7	Reference condition	0: STD 1: NOR
8	Accumulation diagnosis	0: Within the range 1: Outside the range
9	Flow rate diagnostics	0: Within the range 1: Outside the range
10	Outside the output PD range	0: Within the range 1: Outside the range
11	Accumulation shut-off	0: Automatic accumulation shut-off has not occurred 1: Automatic accumulation shut-off has occurred
12	Local input	0: Remote 1: Local
13	Fixed output	0: Normal output 1: Fixed output
14	Error	0: Error not generated 1: Error generated
15	System error	0: Error not generated 1: Error generated
16 to 31	Flow rate measurement (PD)/ Measured value of the flow meter	With code symbol: 16 bit
32 to 47	Accumulated measurement value [upper byte]	Without code symbol: 32 bit
48 to 63	Accumulated measurement value [lower byte]	

Output process data





Bit offset	15	14	13	12	11	10	9	8	7	6	5	4	3	2	1	0
Item	Commanded flow rate (PD)															

Bit offset	Item	Remarks
0 to 15	Commanded flow rate	With code symbol: 16 bit

Communication with master	IO-Link communication status	Status	Display indication	Content		
Yes		Normal	Operate		Normal communication status (Output PD disabled)	
			Operate valid		Normal communication status (Output PD enabled)	
		Start up		At the start of communication		
		Preoperate				
No		IO-Link mode	Version does not match		IO-Link version does not match with master	
			Communication shut-off	Operate		Normal communication was not received for 1 s or longer.
				Operate valid		
			StartUp			
			PreOperate			
		SIO mode	SIO		General switch output	

\* If the version of the connected IO-Link master is something other than "V1.1," the display will show an error.

## Flow Controller Flow Rate Variations

Series	Applicable fluid	Control accuracy	Repeatability	Enclosure	IO-Link Compatible	Port size	Rated flow range [L/min]															
							0.1	1	10	25	50	100	200	300	500	1000	2000					
<b>PFCA7</b>  <p>p. 7</p>	Dry air N <sub>2</sub> Ar CO <sub>2</sub>	±3% F.S. * For dry air	±1% F.S.	IP40	●	ø4, ø6, ø8, ø1/4" (Rc, NPT, G) 1/8, 1/4	0.1 10															
							0.2 25															
							0.5 50															
							1 100															
<b>IN502-44/45</b>  	Dry air N <sub>2</sub>	±5% F.S.	±2% F.S. * Includes a control dead band (F.S. ±1%)	IP65	●	Rc1/2			50 500				100 1000									
<b>PFCQ</b>  	Dry air N <sub>2</sub>	±3% F.S.*1	±1% F.S.	IP40	—	Rc1/2	9 300															

\*1 Operating differential pressure: 0.3 MPa, Temperature: 25°C



# CONTENTS

## Flow Controller for Air *PFCA7 Series*



How to Order .....	p. 7
Specifications .....	p. 8
Flow Rate/Analog Input/Analog Output .....	p. 9
Internal Circuits and Wiring Examples .....	p. 10
Construction: Parts in Contact with Fluid .....	p. 11
Dimensions .....	p. 12
Safety Instructions .....	Back cover

## How to Order



PFCA7 **10** - **C6** - **1** **□** - **M** **□** **□**

①
②
③
④
⑤
⑥
⑦

### ① Rated control flow range

Model	Rated control flow range
<b>10</b>	0.1 to 10 L/min
<b>25</b>	0.2 to 25 L/min
<b>50</b>	0.5 to 50 L/min
<b>11</b>	1 to 100 L/min

### ② Port size

Model	Port size	Rated control flow range			
		10	25	50	11
<b>01</b>	Rc1/8	●	●	●	—
<b>N1</b>	NPT1/8	●	●	●	—
<b>F1</b>	G1/8	●	●	●	—
<b>02</b>	Rc1/4	—	—	—	●
<b>N2</b>	NPT1/4	—	—	—	●
<b>F2</b>	G1/4	—	—	—	●
<b>C4</b>	φ4	●	—	—	—
<b>C6</b>	φ6	●	●	●	●
<b>C8</b>	φ8	—	●	●	●
<b>N7</b>	φ1/4"	—	●	●	●

### ③ Input/output specifications

Model	IN	OUT1	OUT2
<b>1</b>	Analogue input (1 to 5 V)	IO-Link/NPN/PNP	Analogue output (1 to 5 V ⇔ 0 to 10 V)*1
<b>2</b>	Analogue input (4 to 20 mA)	IO-Link/NPN/PNP	Analogue output (4 to 20 mA)

\*1 1 to 5 V or 0 to 10 V can be selected by pressing the button. The default setting is 1 to 5 V.

### ④ Option 1

Symbol	Content
<b>Nil</b>	With lead wire with connector (3 m/5 core) <b>ZS-53-A</b>
<b>N</b>	Without lead wire with function
<b>Q</b>	M12-M12 lead wire with connector (3 m/5 core)*2 <b>ZS-53-D</b>

\*2 One side has an M12 (socket), and the other side has an M12 (plug) lead wire with a connector.

### ⑤ Unit specification

Model	Content
<b>Nil</b>	Unit specification*3
<b>M</b>	SI unit only*4

\*3 This product is for overseas use only. (The SI unit type is provided for use in Japan in accordance with the New Measurement Act.)  
The unit can be changed. Instantaneous flow: L/min ⇔ cfm  
Accumulated flow: L ⇔ ft<sup>3</sup>

\*4 Fix unit Instantaneous flow: L/min  
Accumulated flow: L

### ⑥ Option 2

Model	Content
<b>Nil</b>	None
<b>R</b>	Bracket (mounting position: Side) <b>ZS-40-L</b>
<b>S</b>	Bracket (mounting position: Stream side) <b>ZS-53-G</b>

### ⑦ Operation manual/Calibration certificate\*5

Model	Content	
	Operation manual	Calibration certificate
<b>Nil</b>	●	—
<b>Y</b>	—	—
<b>K</b>	●	●
<b>T</b>	—	●

\*5 The certificate is in both English and Japanese.



For flow switch precautions and specific product precautions, refer to the "Operation Manual" on the SMC website.

## Specifications

Model		PFCA710	PFCA725	PFCA750	PFCA711	
<b>Fluid</b>	Applicable fluid*1	Dry air, N <sub>2</sub> , Ar, CO <sub>2</sub> (JIS B 8392-1:2012 [1:6:2], ISO 8573-1:2010 [1:6:2])				
	Fluid temperature range	0 to 50°C				
<b>Flow</b>	Detection method	Heating type sensor				
	Rated control flow range*2	Dry air, N <sub>2</sub> , Ar	0.1 to 10 L/min	0.2 to 25 L/min	0.5 to 50 L/min	1 to 100 L/min
		CO <sub>2</sub>	0.1 to 5 L/min	0.2 to 12.5 L/min	0.5 to 25 L/min	1 to 50 L/min
	Set controlled flow rate range*2	Dry air, N <sub>2</sub> , Ar	0.04 to 10.3 L/min	0.1 to 25.8 L/min	0.2 to 51.5 L/min	0.4 to 103 L/min
		CO <sub>2</sub>	0.04 to 5.15 L/min	0.1 to 12.9 L/min	0.2 to 25.8 L/min	0.4 to 51.5 L/min
	Set-up setting control flow rate minimum unit	0.01 L/min		0.1 L/min		
	Set accumulated flow range	0.0 to 99999999.9 L		0 to 999999999 L		
	Minimum unit of accumulated flow rate	0.1 L		1 L		
	Accumulated volume per pulse	0.1 L/pulse		1 L/pulse		
	Accumulated-value hold function*3	Select from every 2 or 5 minutes				
<b>Control specifications*4</b>	Control accuracy	±3% F.S.				
	Analog output accuracy*5	±3% F.S.				
	Repeatability	±1% F.S.				
	Temperature characteristics	±5% F.S. (0 to 50°C, Reference: 25°C)				
	Pressure characteristics	±2% F.S. (reference operating pressure)				
	Settling time*6	Reaches within ±3% F.S. of the commanded flow rate in 0.5 seconds or less (Under the reference conditions)		Reaches within ±3% F.S. of the commanded flow rate in 1 second or less (Under the reference conditions)		
	Control specification method	IO-Link, analogue input, local setting				
<b>Analogue input</b>	Voltage	Input type	1 to 5 V			
		Input impedance	1 MΩ approx.			
	Current	Input type	4 to 20 mA			
		Input impedance	250 Ω or less			
<b>Analogue output</b>	Voltage	Output type	Select from 1 to 5 V or 0 to 10 V			
		Output impedance	1 MΩ approx.			
	Current	Output type	4 to 20 mA			
		Load impedance	50 to 600 Ω			
<b>Switch output</b>	Output type	Select from NPN or PNP open collector output				
	Output mode	Limit deviation tolerance mode, accumulated output, accumulated pulse output, error output, switch output off				
	Switch operation	Select from normal output or reversed output				
	Maximum load current	80 mA				
	Maximum applied voltage (Only NPN)	30 VDC				
	Internal voltage drop	1.5 V or less (at 80 mA load current)				
	Delay time	5 ms or less, variable from 0 to 60 s/0.01 s increments				
<b>Pressure</b>	Operating pressure range*7	50 to 250 kPa	100 to 300 kPa	150 to 300 kPa	250 to 350 kPa	
	Minimum operational differential pressure*8	50 kPa	100 kPa	150 kPa	250 kPa	
	Reference operating pressure*9	100 kPa	150 kPa	200 kPa	300 kPa	
	Withstand pressure	1 MPa				
<b>Electrical</b>	Power supply voltage	24 VDC ±10%				
	Current consumption*10	200 mA or less				
<b>Display</b>	Protection	Power supply polarity protection				
	Reference condition*11	Select from standard condition (STD) and normal condition (NOR)				
	Display mode	Main display: Instantaneous flow rate value				
		Sub display: Select from the set control flow rate value, IO-Link status, accumulated flow rate value, peak/bottom value, and line name.				
	Unit*12	Instantaneous flow	L/min, cfm			
		Accumulated flow	L, ft <sup>3</sup>			
	Displayable range	Instantaneous flow	-0.5 to 10.5 L/min	-1.3 to 26.3 L/min	-2.5 to 52.5 L/min	-5 to 105 L/min
Accumulated flow		0.0 to 99999999.9 L				
Minimum display units	Instantaneous flow	0.01 L/min		0.1 L/min		
	Accumulated flow	0.1 L		1 L		
Display	LCD (Can be rotated 90, 180, and 270 degrees)					
<b>Mounting orientation</b>		The display cannot be mounted with the screen facing down				
<b>Environmental resistance</b>	Enclosure rating	IP40				
	Withstand voltage	1000 VAC for 1 min between terminals and housing				
	Insulation resistance	50 MΩ or more (500 VDC measured via megohmmeter) between terminals and housing				
	Operating temperature range	Operating: 0 to 50°C, Stored: 0 to 60°C (No freezing or condensation)				
Standard	CE/UKCA marking					
<b>Piping</b>	One-touch fitting	C4 (ø4)/C6 (ø6)	C6 (ø6)/N7 (ø1/4")/C8 (ø8)			
	Screw fitting	01 (Rc1/8)/F1 (NPT1/8)/N1 (G1/8)			02 (Rc1/4)/F2 (NPT1/4)/N2 (G1/4)	
<b>Materials in contact with fluid</b>		PPS, FKM, Stainless steel, Brass, PTFE, Si, Au, GE4F				
<b>Weight</b>	Product	One-touch fitting	Approx. 255 g			
		Screw fitting	Approx. 305 g			
	Lead wire (ZS-53-A)	Approx. 180 g				
	Bracket (ZS-40-L)	+25 g				

- \*1 Refer to the "Recommended Pneumatic Circuit Examples" on page 2.
- \*2 The operation may be unstable outside the rated control flow range.
- \*3 When using the accumulated value hold function, calculate the product life from the operating conditions, and use the product within its life. The maximum access limit of the memory device is approximately 1 million cycles. The product life is as follows when energized for 24 hours a day.
  - Data stored every 5 minutes ---  
5 minutes x 1 million times = 5 million minutes = approx. 9.5 years
  - Data stored every 2 minutes ---  
2 minutes x 1 million times = 2 million minutes = approx. 3.8 years
- \*4 Applicable fluid: The specification value when dry air is shown. For gas types other than air, the value is for reference.
- \*5 For the analogue voltage, option 1, lead wire with M12 connector (3-m long), is used. If the lead wire is different, the accuracy may fluctuate depending on the wiring resistance.
- \*6 The reference conditions are as follows: pressure: reference operating pressure; temperature: 25°C; commanded flow rate: step change from 1% to 100%. In other conditions, the setting time may be delayed.
- \*7 The operating pressure range refers to the pressure that can be applied to the primary side of the product. This product cannot be used for negative pressure.
- \*8 This is the min. differential pressure (inlet and outlet pressure differential) required for the normal operation of the product. Do not install a restrictor in the vicinity of this product's outlet side, as this may result in unstable control operation.
- \*9 The pressure on the secondary side of the product is open to atmosphere (0 kPa).
- \*10 Analogue output and switch output are not included. If there is no supply pressure, a consumption current beyond the product specifications may flow in the event of an error in control operation.
- \*11 Standard condition (STD): 20°C, 101.3 kPa, 65% R.H. (The flow rate given in the specification is the value at the standard condition)  
Normal condition (NOR): 0°C, 101.3 kPa, 0% R.H.
- \*12 This setting is only available for models with the units selection function. For models without the units selection function, the instantaneous flow is L/min and the accumulated flow (rate) is fixed to L.
- \*13 SMC are working to improve quality. However, any products with tiny scratches, smear, dead-pixel, or variation in the display colour or brightness which does not affect the performance of the product, are verified as conforming products.

# PFCA7 Series

## Flow Rate Range

### Control the flow rate within the rated control flow rate range.

The rated control flow rate range is the flow rate range that satisfies the specifications of the product (accuracy, etc.).

The set control flow rate range is the flow rate range in which the flow rate command value can be set.

Even if the rated control flow rate range is exceeded, the flow rate command value can be set within the set control flow rate range. However, it cannot be guaranteed that the specifications will be satisfied in such cases.

The flow rate for CO<sub>2</sub> is shown in parentheses.

Model	Flow range [L/min]					
	-5	0	10	25	50	100
PFCA710	0.1 L/min	10 L/min (5 L/min)				
	0.04 L/min	10.3 L/min (5.15 L/min)				
	-0.5 L/min	10.5 L/min (5.25 L/min)				
PFCA725	0.2 L/min	25 L/min (12.5 L/min)				
	0.1 L/min	25.8 L/min (12.9 L/min)				
	-1.3 L/min	26.3 L/min (13.1 L/min)				
PFCA750	0.5 L/min	50 L/min (25 L/min)				
	0.3 L/min	51.5 L/min (25.8 L/min)				
	-2.5 L/min	52.5 L/min (26.3 L/min)				
PFCA711	1 L/min	100 L/min (50 L/min)				
	0.4 L/min	103 L/min (51.5 L/min)				
	-5.0 L/min	105 L/min (52.5 L/min)				

Rated control flow rate range  
  Set control flow rate range  
  Displayable range

## Flow Rate Command Value/Analog Input

	A	B	C		D	E
			PFCA710/750/711	PFCA725		
Voltage input (1 to 5 V)	1 V	1.016 V	1.04 V	1.032 V	5 V	5.12 V
Current input (4 to 20 mA)	4 mA	4.064 mA	4.16 mA	4.128 mA	20 mA	20.48 mA

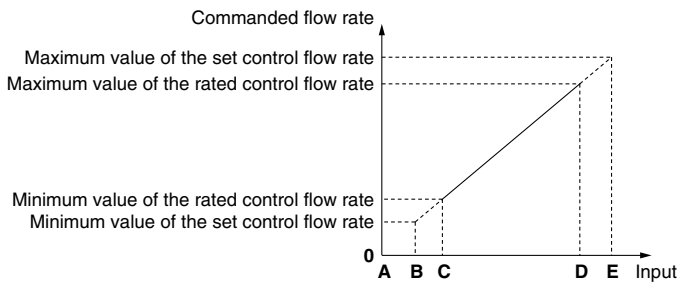

## Flow Rate/Analogue Output

	A	B		C
		PFCA710/750/711	PFCA725	
Voltage output (1 to 5 V)	1 V	1.04 V	1.032 V	5 V
Current output (4 to 20 mA)	4 mA	4.16 mA	4.128 mA	20 mA

	D	E		F
		PFCA710/750/711	PFCA725	
Voltage output (0 to 10 V) *1	0 V	0.1 V	0.08 V	10 V

\*1 Set the current that flows from the connected equipment to the analogue output to 20 μA or less when selecting 0 to 10 V. When more than 20 μA current flows, it is possible that the accuracy will not be satisfied below 0.5 V.

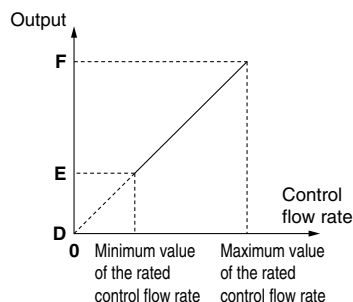
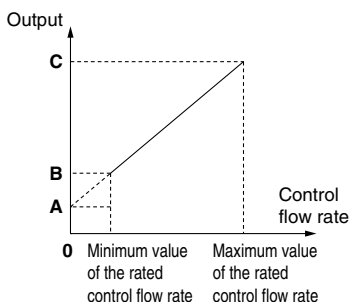

## Internal Circuits and Wiring Examples

### NPN type

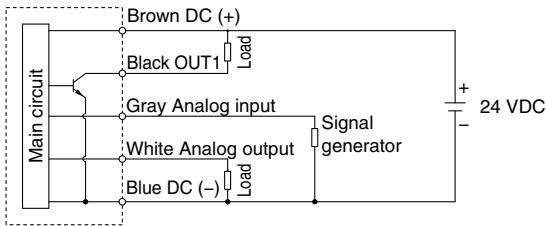

Maximum applied voltage: 30 V  
 Maximum load current: 80 mA  
 Internal voltage drop: 1.5 V or less

#### PFCA7□-□-1□-□□□

Analogue output: 1 to 5 V or 0 to 10 V  
 Output impedance: Approx. 1 kΩ  
 Analogue input: 1 to 5 V  
 Input impedance: Approx. 1 MΩ

#### PFCA7□-□-2□-□□□

Analogue output: 4 to 20 mA  
 Load impedance: 50 to 600 Ω  
 Analogue input: 4 to 20 mA  
 Input impedance: 250 Ω or less

### PNP type

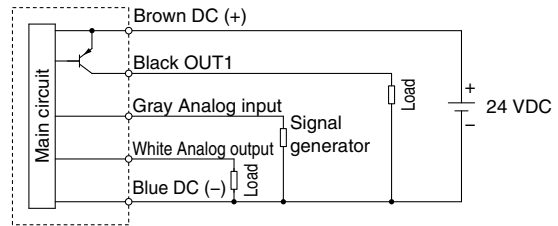

Maximum load current: 80 mA  
 Internal voltage drop: 1.5 V or less

#### PFCA7□-□-1□-□□□

Analogue output: 1 to 5 V or 0 to 10 V  
 Output impedance: Approx. 1 kΩ  
 Analogue input: 1 to 5 V  
 Input impedance: Approx. 1 MΩ

#### PFCA7□-□-2□-□□□

Analogue output: 4 to 20 mA  
 Load impedance: 50 to 600 Ω  
 Analogue input: 4 to 20 mA  
 Input impedance: 250 Ω or less

### When used as an IO-Link device

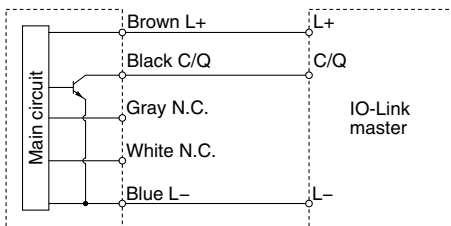

# PFCA7 Series

## Construction: Parts in Contact with Fluid

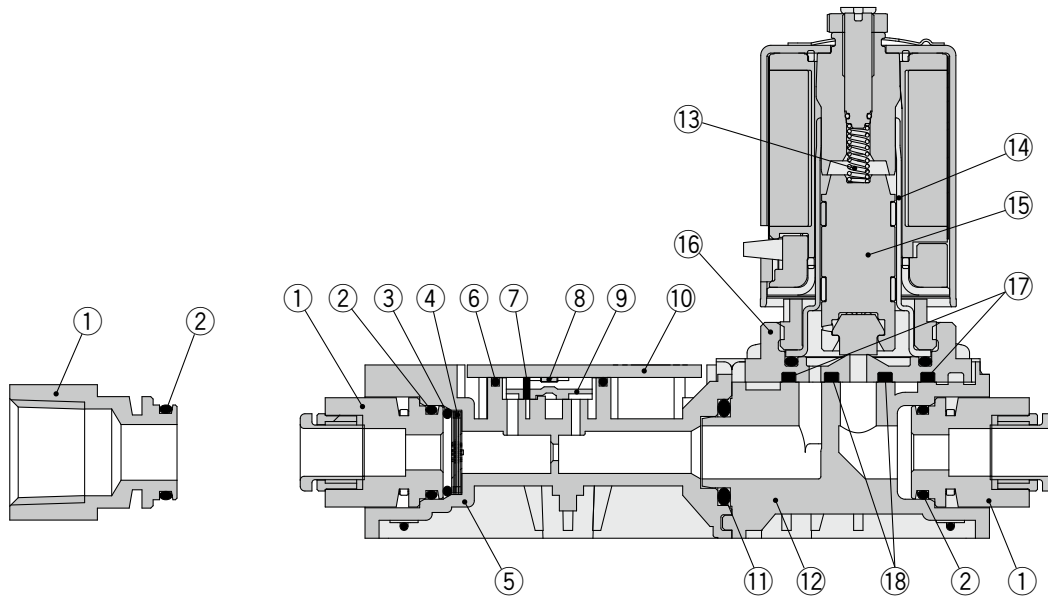

### Component Parts

No.	Description	Material	Remarks
1	Piping fitting	Brass	Electroless nickel plating
2	O-ring	FKM	Fluorine coated
3	O-ring	FKM	Fluorine coated
4	Rectification meshing	Stainless steel 304	
5	Body	PPS	
6	Gasket	FKM	
7	Rectification meshing	Stainless steel 304	
8	Sensor chip	Silicon	
9	Body B	PPS	
10	Board	GR4F	
11	O-ring	FKM	Fluorine coated
12	Body	PPS	
13	Spring	Stainless steel	
14	Tube assembly	Stainless steel	
15	Armature assembly	Stainless steel	
		PTFE	
		FKM	Fluorine coated
16	Valve body	Brass	
17	Gasket	FKM	
18	Gasket	FKM	

## Dimensions

### PFCA7□-C4/C6/C8/N7

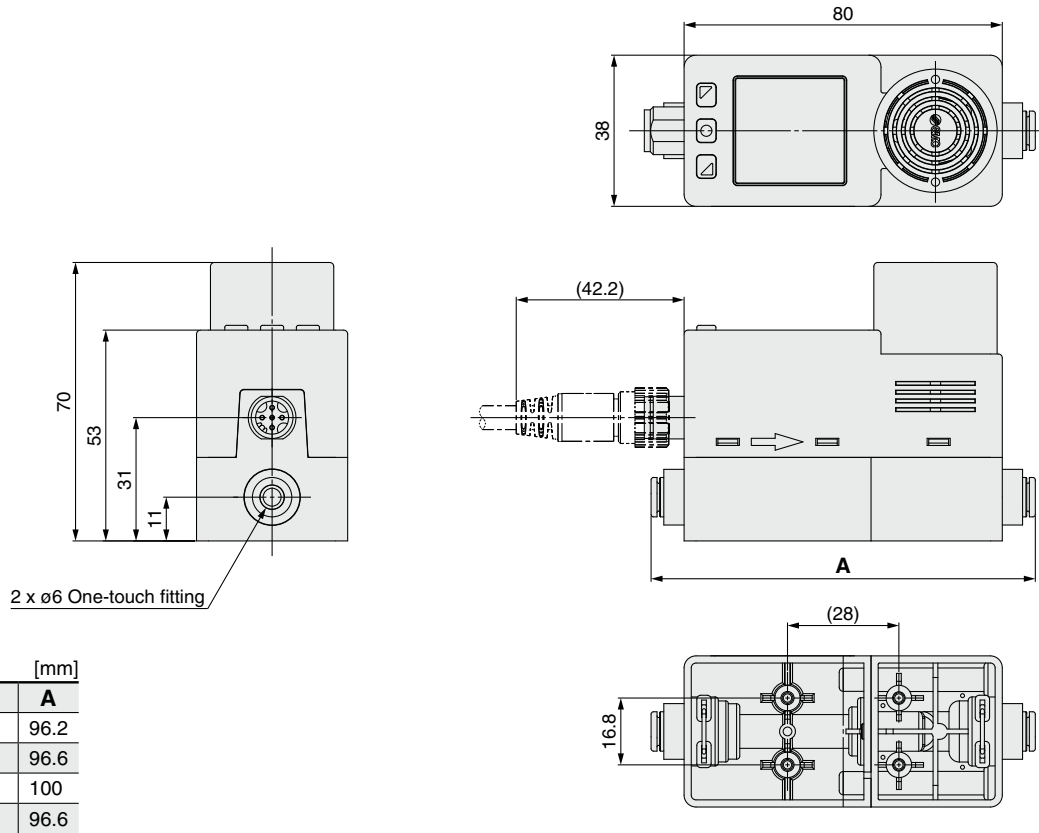

### PFCA7□-01/N1/F1/02/N2/F2

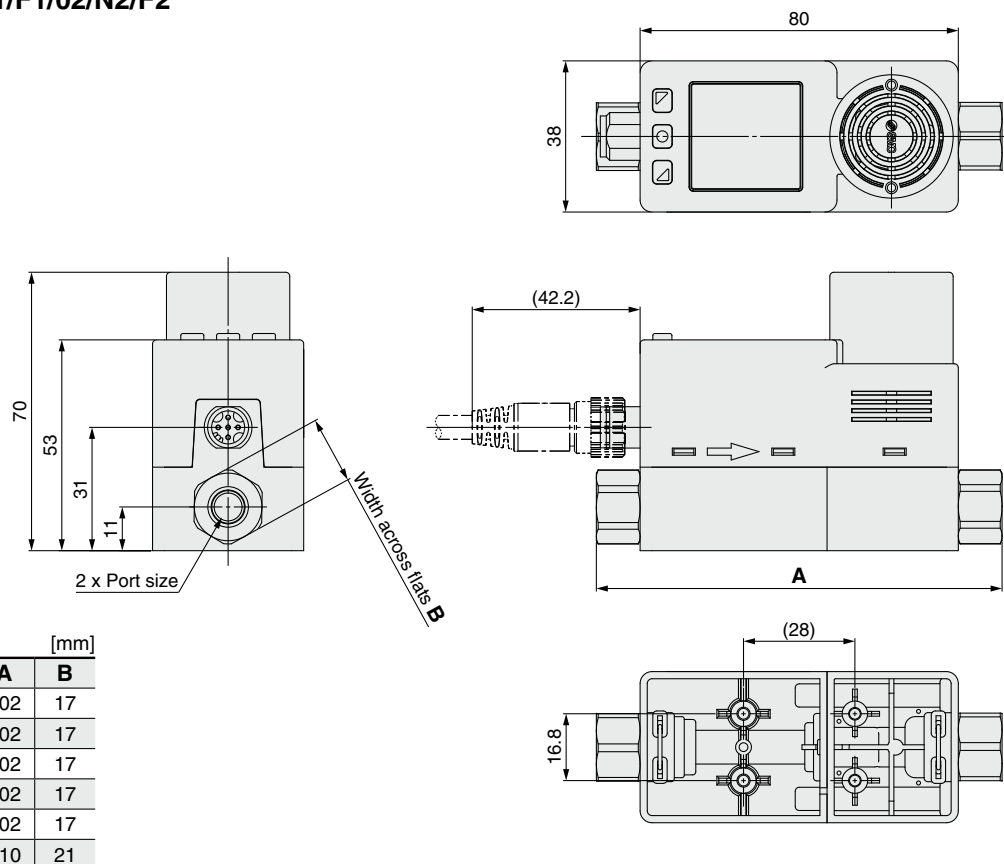

# PFCA7 Series

## Dimensions

### Bracket (ZS-40-L)

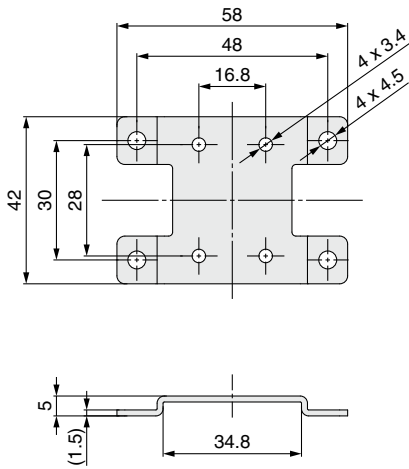

### Bracket (ZS-53-G)

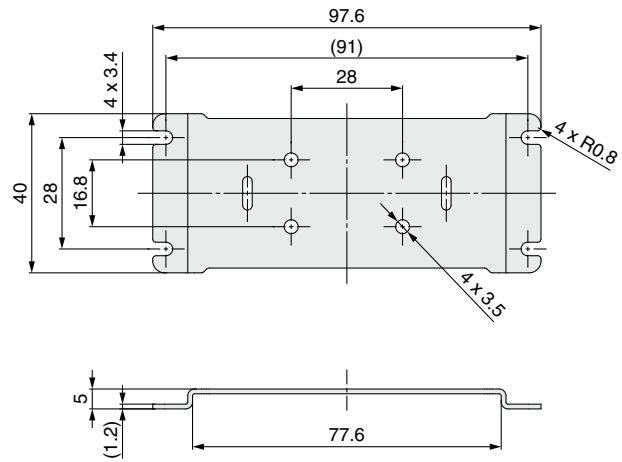

### Lead wire with connector (ZS-53-A)

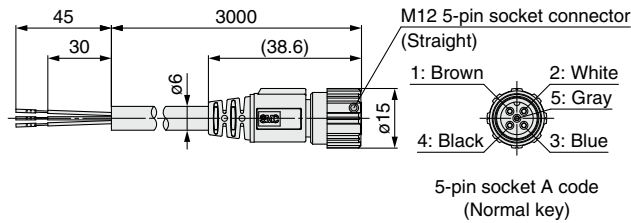

### Lead wire with connector (ZS-53-D)

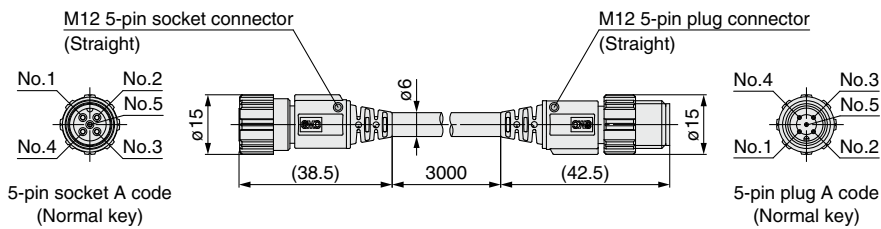



### Cable material specifications

Conductor	Nominal cross section	AWG21
Insulator	O.D.	Approx. 1.60 mm
	Colors	Brown, Gray, White, Black, Blue
Sheath	Material	Oil-resistant PVC
Outer diameter		$\phi 6$

## Safety Instructions

These safety instructions are intended to prevent hazardous situations and/or equipment damage. These instructions indicate the level of potential hazard with the labels of “**Caution**,” “**Warning**” or “**Danger**.” They are all important notes for safety and must be followed in addition to International Standards (ISO/IEC)\*1), and other safety regulations.

 **Danger** : **Danger** indicates a hazard with a high level of risk which, if not avoided, will result in death or serious injury.

 **Warning**: **Warning** indicates a hazard with a medium level of risk which, if not avoided, could result in death or serious injury.

 **Caution**: **Caution** indicates a hazard with a low level of risk which, if not avoided, could result in minor or moderate injury.

\*1) ISO 4414: Pneumatic fluid power - General rules and safety requirements for systems and their components  
ISO 4413: Hydraulic fluid power - General rules and safety requirements for systems and their components  
IEC 60204-1: Safety of machinery - Electrical equipment of machines - Part 1: General requirements  
ISO 10218-1: Robots and robotic devices - Safety requirements for industrial robots - Part 1: Robots etc.

### Warning

#### 1. The compatibility of the product is the responsibility of the person who designs the equipment or decides its specifications.

Since the product specified here is used under various operating conditions, its compatibility with specific equipment must be decided by the person who designs the equipment or decides its specifications based on necessary analysis and test results. The expected performance and safety assurance of the equipment will be the responsibility of the person who has determined its compatibility with the product. This person should also continuously review all specifications of the product referring to its latest catalog information, with a view to giving due consideration to any possibility of equipment failure when configuring the equipment.

#### 2. Only personnel with appropriate training should operate machinery and equipment.

The product specified here may become unsafe if handled incorrectly. The assembly, operation and maintenance of machines or equipment including our products must be performed by an operator who is appropriately trained and experienced.

#### 3. Do not service or attempt to remove product and machinery/equipment until safety is confirmed.

1. The inspection and maintenance of machinery/equipment should only be performed after measures to prevent falling or runaway of the driven objects have been confirmed.
2. When the product is to be removed, confirm that the safety measures as mentioned above are implemented and the power from any appropriate source is cut, and read and understand the specific product precautions of all relevant products carefully.
3. Before machinery/equipment is restarted, take measures to prevent unexpected operation and malfunction.

#### 4. Our products cannot be used beyond their specifications. Our products are not developed, designed, and manufactured to be used under the following conditions or environments. Use under such conditions or environments is not covered.

1. Conditions and environments outside of the given specifications, or use outdoors or in a place exposed to direct sunlight.
2. Use for nuclear power, railways, aviation, space equipment, ships, vehicles, military application, equipment affecting human life, body, and property, fuel equipment, entertainment equipment, emergency shut-off circuits, press clutches, brake circuits, safety equipment, etc., and use for applications that do not conform to standard specifications such as catalogs and operation manuals.
3. Use for interlock circuits, except for use with double interlock such as installing a mechanical protection function in case of failure. Please periodically inspect the product to confirm that the product is operating properly.

### Caution

**We develop, design, and manufacture our products to be used for automatic control equipment, and provide them for peaceful use in manufacturing industries.**

**Use in non-manufacturing industries is not covered.**

Products we manufacture and sell cannot be used for the purpose of transactions or certification specified in the Measurement Act.

The new Measurement Act prohibits use of any unit other than SI units in Japan.

### Limited warranty and Disclaimer/ Compliance Requirements

The product used is subject to the following “Limited warranty and Disclaimer” and “Compliance Requirements”.

Read and accept them before using the product.

#### Limited warranty and Disclaimer

1. The warranty period of the product is 1 year in service or 1.5 years after the product is delivered, whichever is first.\*2)  
Also, the product may have specified durability, running distance or replacement parts. Please consult your nearest sales branch.
2. For any failure or damage reported within the warranty period which is clearly our responsibility, a replacement product or necessary parts will be provided.  
This limited warranty applies only to our product independently, and not to any other damage incurred due to the failure of the product.
3. Prior to using SMC products, please read and understand the warranty terms and disclaimers noted in the specified catalog for the particular products.

\*2) **Vacuum pads are excluded from this 1 year warranty.**

A vacuum pad is a consumable part, so it is warranted for a year after it is delivered.

Also, even within the warranty period, the wear of a product due to the use of the vacuum pad or failure due to the deterioration of rubber material are not covered by the limited warranty.

#### Compliance Requirements

1. The use of SMC products with production equipment for the manufacture of weapons of mass destruction (WMD) or any other weapon is strictly prohibited.
2. The exports of SMC products or technology from one country to another are governed by the relevant security laws and regulations of the countries involved in the transaction. Prior to the shipment of a SMC product to another country, assure that all local rules governing that export are known and followed.

## Safety Instructions

Be sure to read the “Handling Precautions for SMC Products” (M-E03-3) and “Operation Manual” before use.

## SMC Corporation

Akihabara UDX 15F,  
4-14-1, Sotokanda, Chiyoda-ku, Tokyo 101-0021, JAPAN  
Phone: 03-5207-8249 Fax: 03-5298-5362  
<https://www.smcworld.com>  
© 2024 SMC Corporation All Rights Reserved

Specifications are subject to change without prior notice and any obligation on the part of the manufacturer.

D-G