

Vacuum Manifold for Fieldbus System



IP65

Vacuum Unit/Positive Pressure Unit

Vacuum pads and actuator driving can be controlled with a single manifold

New Positive pressure unit [p. 3](#)

5-port solenoid valve

- 2-position single
- 2-position double
- 4-position dual 3-port valve

Vacuum unit

Energy saving ejector

CO₂ emissions (Air consumption) **92% reduction**

Reduced by the energy saving SI unit, built-in pressure sensor, and efficient ejectors

(Under SMC's measurement conditions)

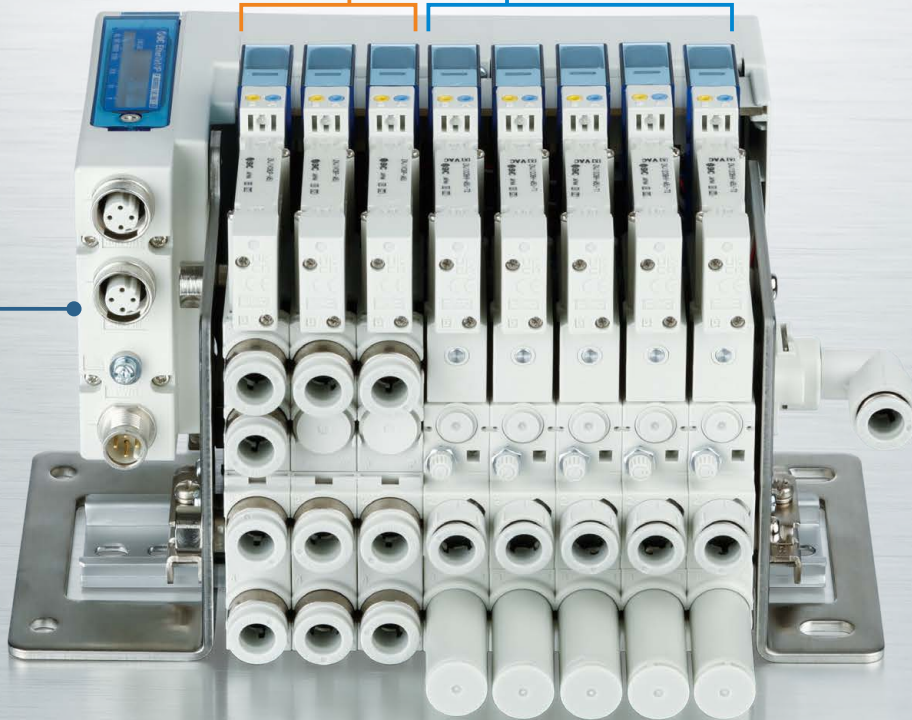

Fieldbus compatible

- Space saving: Requires no separate input/output units
- Reduced wiring time
- Compatible protocols



Exhaust sealing function [p. 4](#)

Quick workpiece release

4 stations/8 stations/12 stations/
16 stations manifold compatible

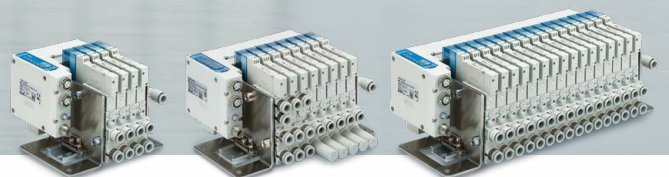

ZKJ Series



CAT.ES100-140B

Energy saving

Air saving by the energy saving SI unit, built-in pressure sensor, and efficient ejectors

CO₂ emissions (Air consumption)

92% reduction *1

*1 Under SMC's measurement conditions

Energy saving function ON

Air is supplied **intermittently** when the vacuum decreases.

Energy saving function OFF

Air is supplied **continuously** during the adsorption of the workpiece.

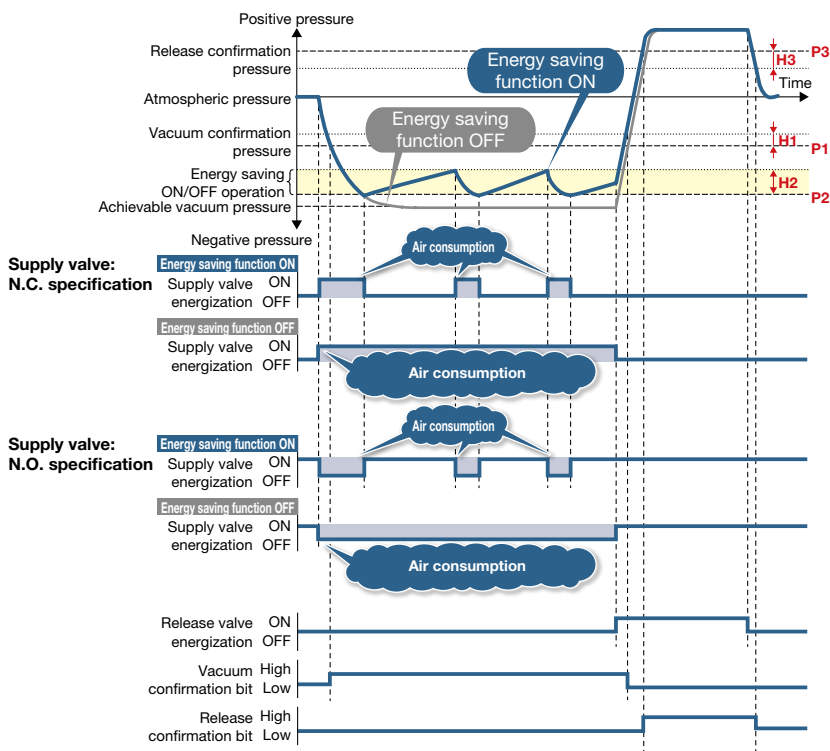

Energy saving efficiency: 92% reduction

Power consumption cost per year reduced by 13,196 JPY/year*2

	Power consumption cost per year	Annual air consumption	Exhaust time	Air consumption
ZKJ/Energy saving function ON (Part no.: ZKJ12C8P-A5U-T1)	1,148 JPY/year	765 m ³ /year	0.6 s	68 L/min
Existing model (Part no.: ZM131AM-K5LZ-E15)	14,344 JPY/year	9562.5 m ³ /year	6 s	85 L/min

*2 **Cost conditions** · Air unit 1.5 JPY/m³ (ANR), Annual operating cycles: 1125000
(Operating hours: 10 hours/day, Operating days: 250 days/year, 450 cycles/h, when 1 unit is used)

Supply valve (N.O.)

Vacuum can be held during a power outage or when the power is turned OFF, preventing the workpiece from dropping.*1

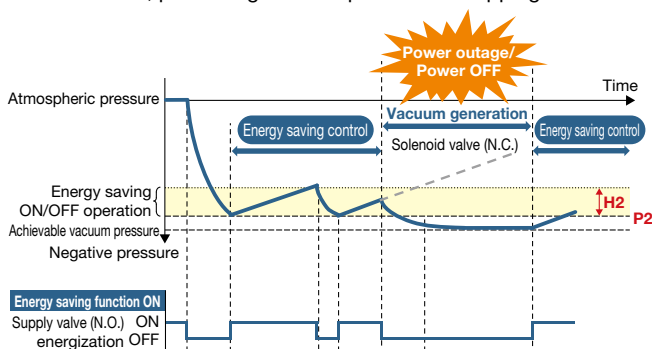

*1 Supposing the supply pressure is being maintained

Valve protection function

If the supply valve reaches the set number of operations while the energy-saving function is in use, the energy-saving function automatically turns OFF and switches to continuous adsorption to prevent excessive valve operation.

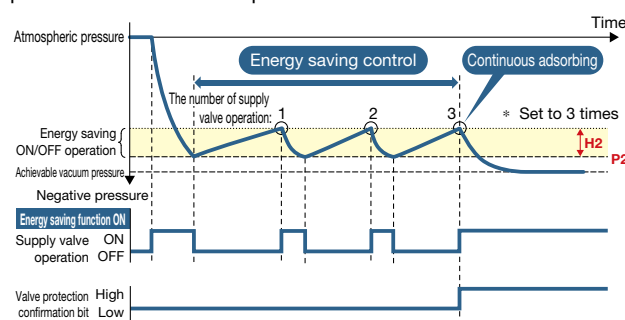

Fieldbus Compatible



EtherNet/IP

EtherCAT

Space saving/Less wiring work

For vacuum manifold for fieldbus system/ZKJ

- Can be connected directly to the PLC via Fieldbus without the need for a commercially available input/output unit
- Less communication/power supply cables and wiring work
- Reduced network load due to the reduction in the number of connected devices
- Simple wiring/Minimized disconnection risk

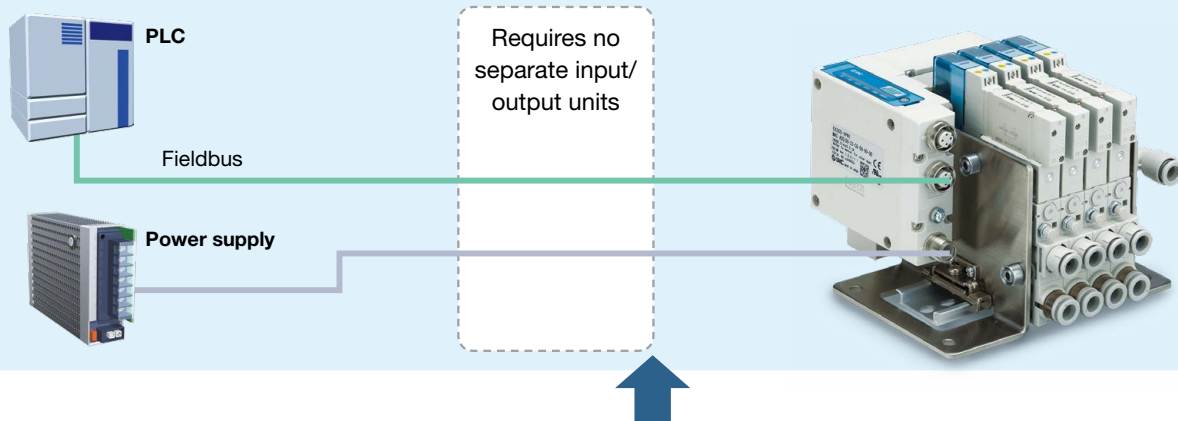

For vacuum unit/ZK2

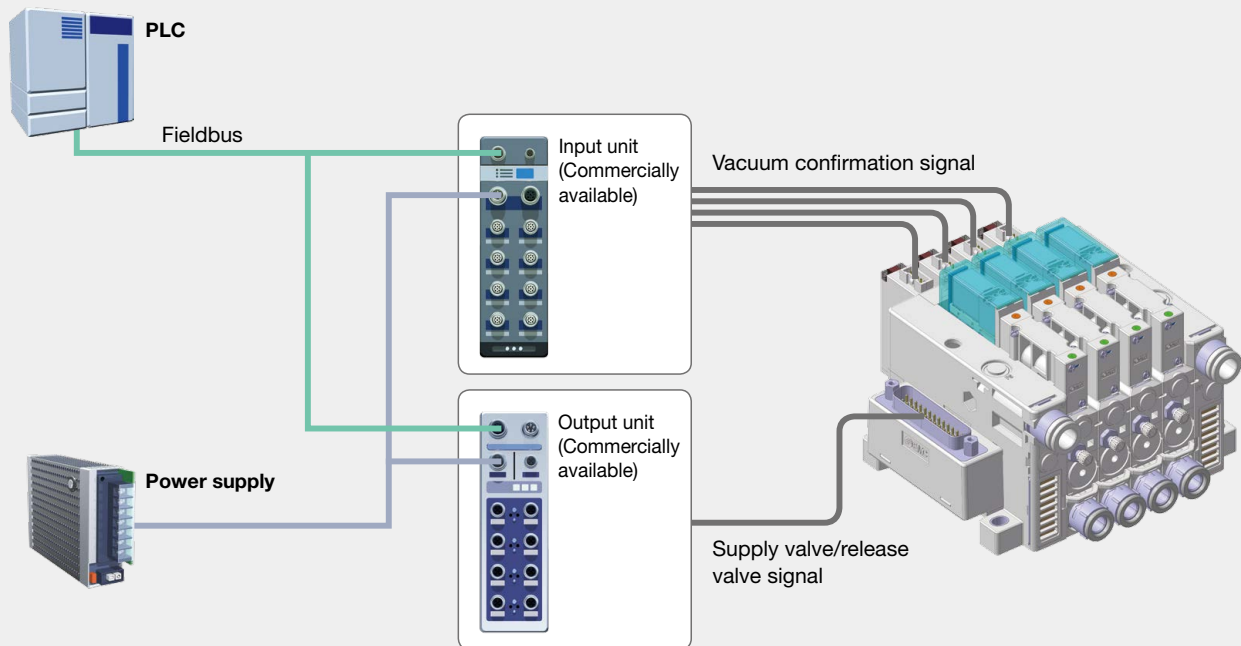

Remote control and monitoring are available.

PLC



Fieldbus

Configurable items

- Energy saving function
- Pressure value (vacuum confirmation (P1, H1), energy saving operation threshold (P2, H2), release confirmation (P3, H3))

Monitoring

- Monitoring pressure of individual vacuum units

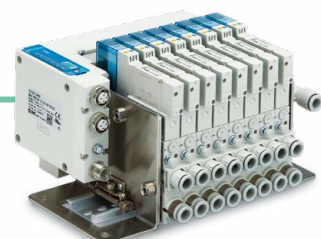

Vacuum ejectors and solenoid valves are mounted on the same manifold.

This allows for a **compact body** and **reduced wiring/wiring labor**.

Manifold stations: 4, 8, 12, 16 (Total number of vacuum unit/positive pressure unit stations)

Positive pressure unit (5-port valve)

For the control of workpiece transfer via air gripper, air cylinder, etc.

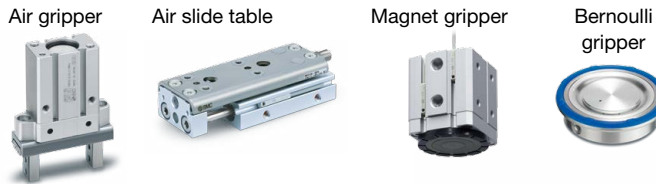

Vacuum unit (Vacuum ejector)

For the control of vacuum suction and release

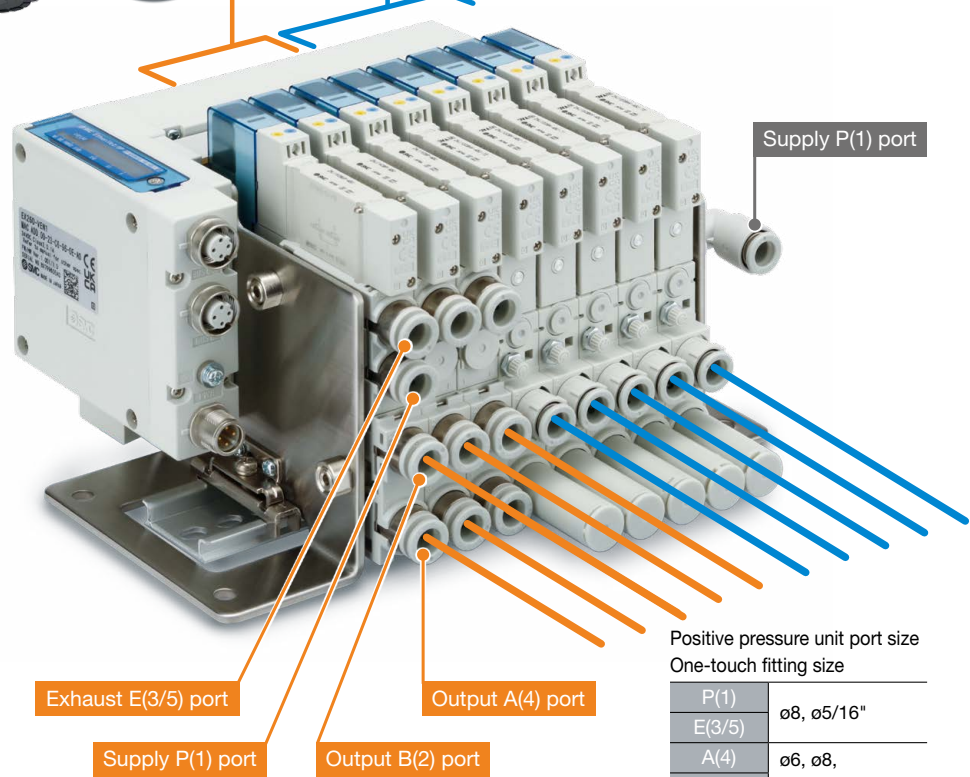
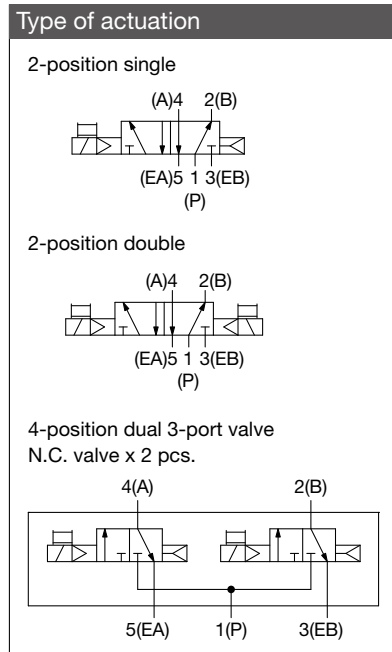

Positive pressure unit port size
One-touch fitting size

P(1)	
E(3/5)	ø8, ø5/16"
A(4)	ø6, ø8,
B(2)	ø1/4, ø5/16"

<p>Positive pressure unit</p> <p>Magnet gripper</p> <p>+</p> <p>Vacuum unit</p> <p>Vacuum pad, etc.</p> <p>Metal workpiece with holes and complicated shape</p>	<p>Positive pressure unit</p> <p>Air gripper</p> <p>+</p> <p>Vacuum unit</p> <p>Vacuum pad, etc.</p> <p>Small robot</p>	<p>Positive pressure unit</p> <p>Air slide table</p> <p>+</p> <p>Vacuum unit</p> <p>Vacuum pad, etc.</p> <p>Pick and place</p>	<p>Positive pressure unit</p> <p>Guide cylinder</p> <p>+</p> <p>Vacuum unit</p> <p>Vacuum pad, etc.</p> <p>Cartoner</p>	<p>Positive pressure unit</p> <p>Bernoulli gripper</p> <p>+</p> <p>Vacuum unit</p> <p>Vacuum pad, etc.</p> <p>Adsorption transfer of workpieces with holes and/or uneven surfaces</p>
---	---	--	---	---

Variations

SI unit/Compatible protocols



Nozzle size

ø0.7, ø1.0, ø1.2, ø1.5

Combination of supply valve and release valve

Supply valve	Release valve
N.O.	N.C.
N.C.	N.C.

Supply valve: N.O. specification available

- Can hold vacuum*1 even when the power goes out or is turned off
 - Prevents the sudden dropping of workpieces*1
- *1 Supposing the supply pressure is being maintained

Manual override for residual pressure release (Option)

Allows for manual vacuum release

Without manual override: Plug
With manual override (Non-locking push type): Red

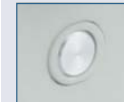

Air pressure supply (P) port

ø8, ø5/16" One-touch fittings

Air pressure supply (P) port

- With One-touch fitting
When operating ejectors simultaneously, if the flow rate from a single air pressure supply (P) port is insufficient, it is possible to select one with a fitting. (Refer to the "Max. Number of Manifold Stations that Can Operate Simultaneously" on page 16.)
- None: Plug

Vacuum (V) port

ø6, ø8, ø1/4", ø5/16" One-touch fittings

Built-in filter: No tools are required.
Reduced replacement labor

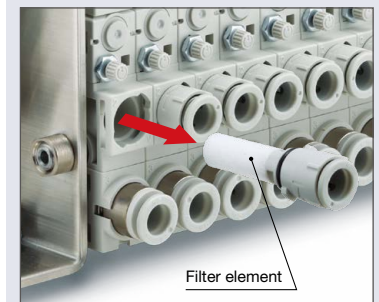

* The vacuum port is located above the exhaust port. The location is different from that of the ZK2 series.

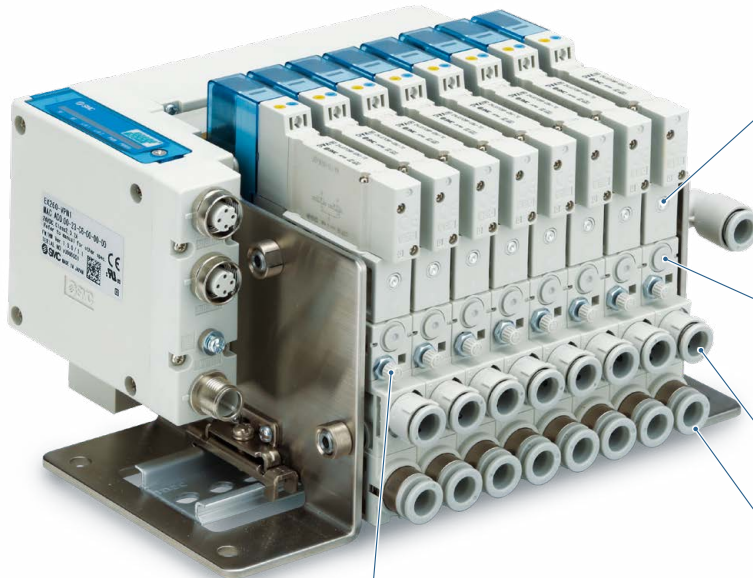

Vacuum release flow adjusting needle

Manual override type



Screwdriver operation type long nut (Option)

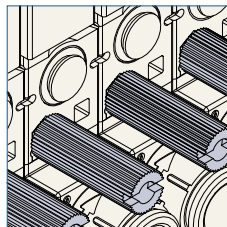

Exhaust (EXH) port

High-noise reduction silencer exhaust (Exhaust noise: 52 [dB(A)])*1

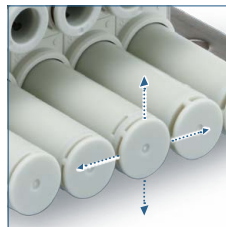

Unpleasant frequencies are removed while maximizing vacuum performance by using a dedicated silencer with better silencing effect.

*1 Adsorbs the workpiece (nozzle diameter ø0.7 (1 station)). (Under SMC's measurement conditions)

Port exhaust*2

With ø8 or ø5/16" One-touch fittings

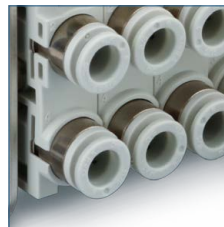

*2 For positive pressure units, only port exhaust is available.

Wiring and piping are integrated on one side.

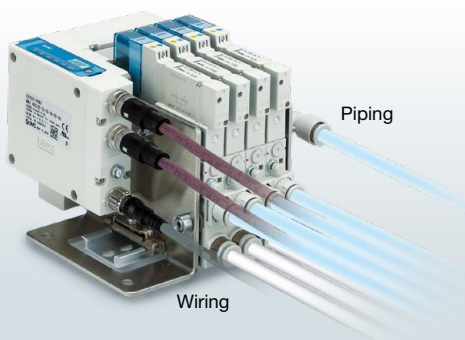

Exhaust sealing function

The built-in exhaust sealing valve seals release air to prevent it from being exhausted from the exhaust (EXH) port. Improved workpiece release

Vacuum release flow rate increased by 2 times
(Under SMC's measurement conditions)
High release pressure allows for the quick release of workpieces.

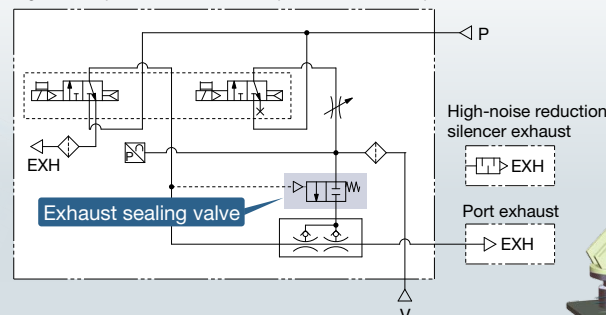

For the type with an exhaust sealing valve, high vacuum release pressure allows for the quick release of workpieces.



PROFINET Compatible

MRP/MRPD function

MRP (Media Redundancy Protocol) function

Communication can be continued even if one of the communication cables in the network is disconnected or damaged. Furthermore, as it is possible to identify the disconnection point quickly, the network disconnection time can be kept within 200 ms.

* In order to use the MRP function, the PLC must be able to support it.

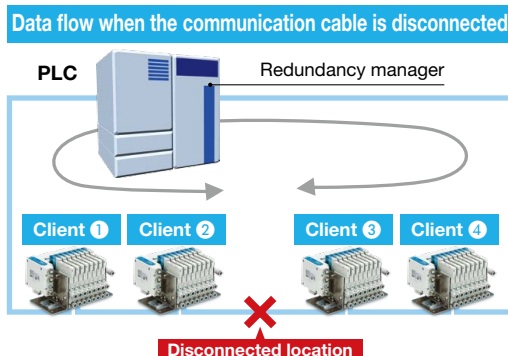
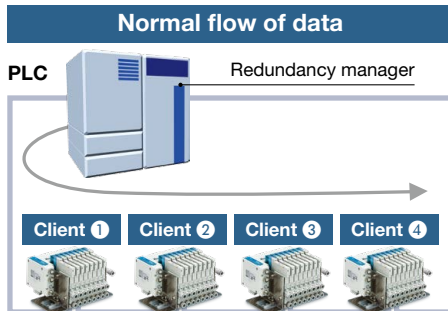

MRPD (Media Redundancy for planned duplication)

It is possible to duplicate routes with a ring topology configured with PROFINET IRT communication.

Communication reconnection time is faster than with the MRP function, so communication can be continued without recovery time.

Fast Start Up function

Time from power ON to communication connection:

Approx. 10 s →

0.5 s or less
for the Fast Start Up function

In the case of a tool changer, it takes about 10 seconds for communication to be connected in some products after the power to the device installed on the tool is turned ON. For products which support the Fast Start Up function, communication can be operational even faster.

* In order to use the Fast Start Up function, the PLC must be able to support it.

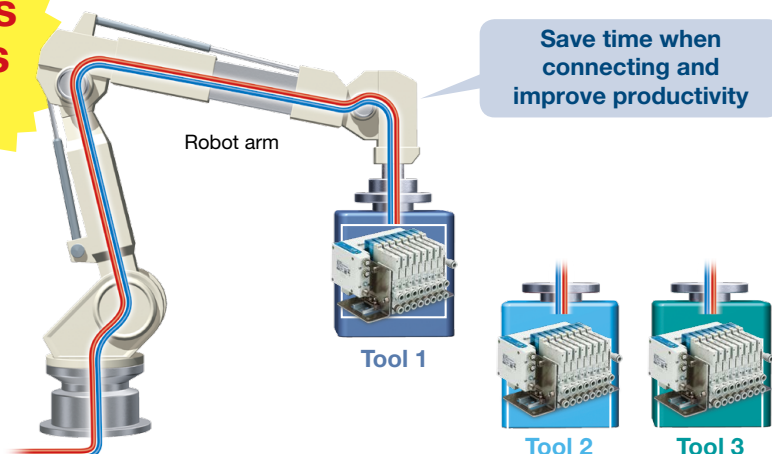

FW (firmware) updates

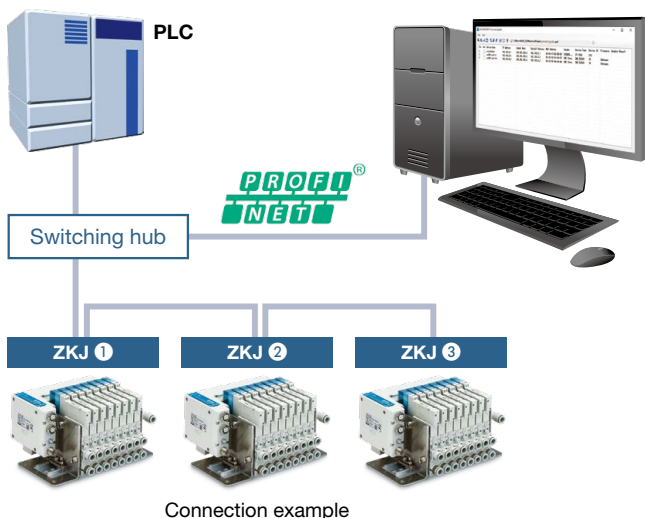

No.	Set	Device Name	IP Address	Subnet Mask	Default Gateway	MAC Address	Vendor	Device Type	Device ID	Firmware	Update Result
1	<input type="checkbox"/>	plc01@plc01	192.168.0.1	255.255.255.0	192.168.0.1	42-84-17-6E-0B-40	SIEMENS	CP-1510	276		
2	<input type="checkbox"/>	ex280-vpn1-4	192.168.0.2	255.255.255.0	192.168.0.2	08-23-08-51-00-07	SMC Corp.	SMC EX08	18	Unknown	
3	<input type="checkbox"/>	ex280-vpn1-16	192.168.0.3	255.255.255.0	192.168.0.3	08-23-08-AA-AA-AA	SMC Corp.	SMC EX08	18	Unknown	

- Batch firmware updating for up to 255 units is possible from the Ethernet line.
- Easy to handle future version upgrades
- * Depending on the product's hardware and firmware versions, it may not be possible to use the firmware update function.

PROFINET Compatible

Shared Device function

An I/O data connected to an SI unit can be controlled and checked by multiple I/O controllers (PLC).

Ex. PLC1 controls the valve
 PLC2 checks pressures or diagnostic data

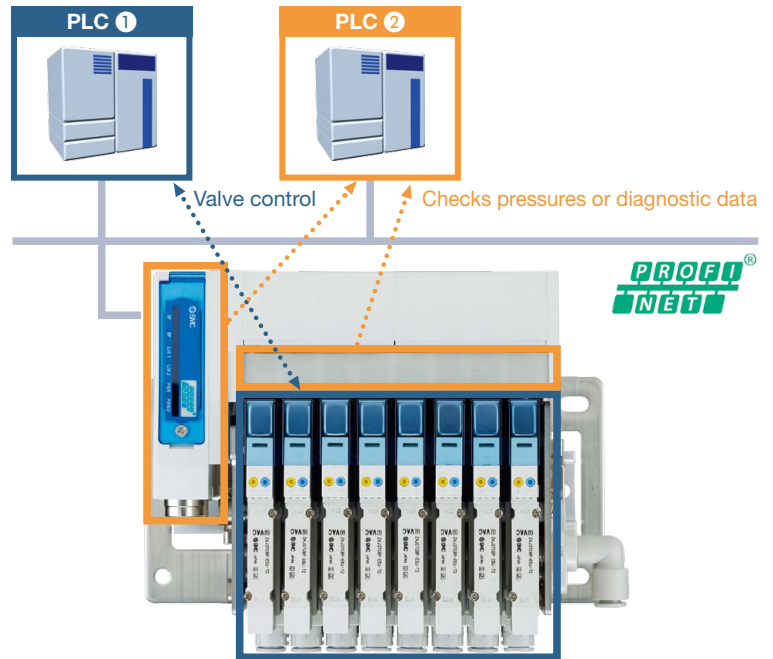

- Information can be shared with up to 3 controllers in addition to the control PLC.
- The cost of the hardware, cables, and installation space can be reduced.

Ex. Information of PLC4 is shared and monitored by PLC1 to 3.
 PLC4 controls the valves and checks pressures.

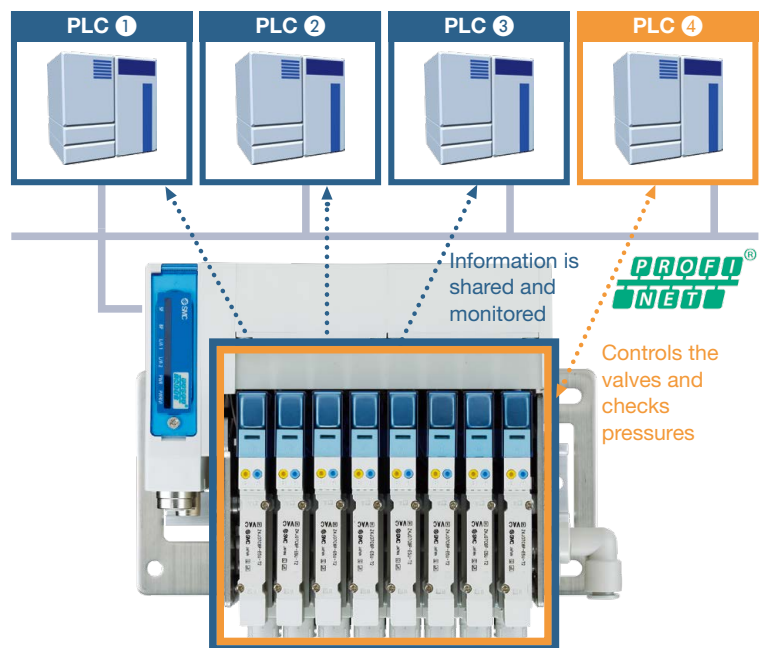

* The Shared Device function enables an I/O module connected to the I/O device to be controlled by multiple I/O controllers (PLC). The control status can be shared among other I/O controllers. As the function can be used across the entire PROFINET line, the cost for hardware, cables, and installation space can be reduced.

IO-Link Compatible IO-Link

Space saving/Less wiring work

- Requires no separate input/output units
- Connectable to various networks via an IO-Link master (Communication is possible without reliance on a Fieldbus or PLC.)
- Less communication/power supply cables and wiring work
- Reduced wiring space
- Reduced network load due to the reduction in the number of Fieldbus connected devices
- Simple wiring/Minimized disconnection risk

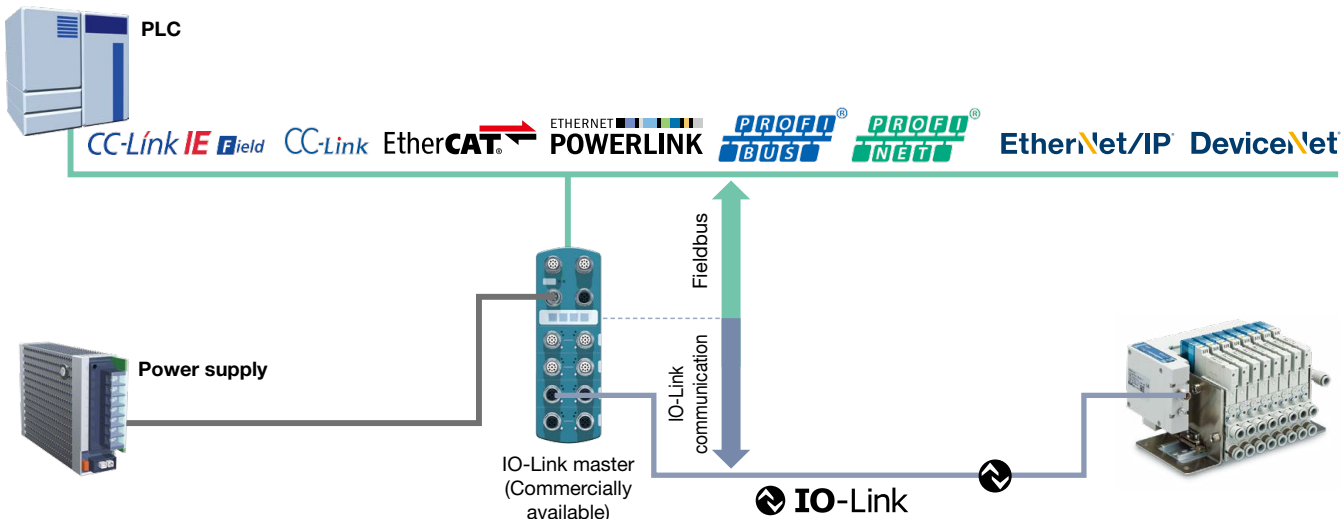

Connectable with a single general-purpose cable

- Port class B**
IO-Link master (Commercially available)
- Connect the IO-Link master port to the device using a 1:1 configuration.
 - Connect using an M12 connector.
 - Maximum cable length: 20 m
 - Special communication cables are not necessary.
 - * In order to connect the SI unit using a single cable, use a port class B type IO-Link master.

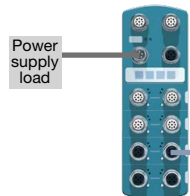

- Port class A**
IO-Link master (Commercially available)



General-purpose 5-wire unshielded cables are used for connection. The signal wire and valve power supply wire can be connected with the same cable.

SI unit/Connector pin arrangement

Pin no.	SI unit port pin function (Port class B)
1	+24 V for control and input
2	+24 V for output
3	0 V for control and input
4	IO-Link communication
5	0 V for output

Y Branch Connector

Port class A compliant
A special wiring Y branch connector is available.



Used when connecting to a port class A type IO-Link master, which is often used when connecting to an IO-Link sensor

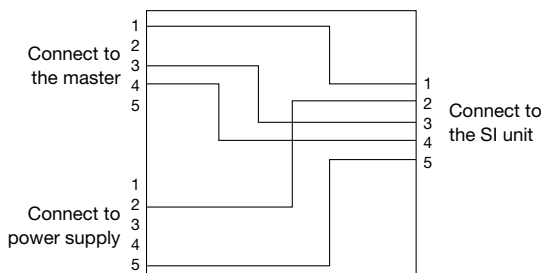

Difference between IO-Link master port class A and class B

Pin no.	IO-Link master port pin function	
	Port class A	Port class B
1	+24 V	+24 V
2	NC/DI/DO	Additional power supply +24 V
3	0 V	0 V
4	IO-Link/DI/DO	IO-Link/DI/DO
5	NC	Additional power supply 0 V

IO-Link Compatible IO-Link

Self-diagnosis function/Automatic parameter saving and writing

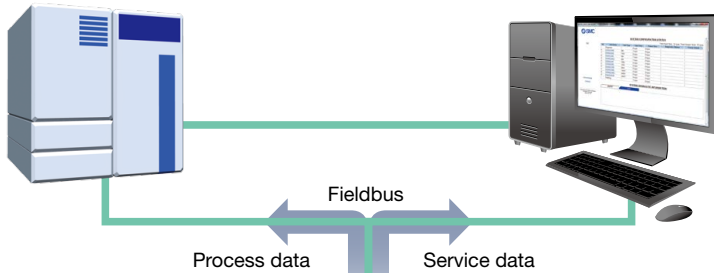

Self-diagnosis contents (Examples)

Diagnostic contents	Event category
Internal failure of the SI unit	Error
Vacuum unit valve short circuit	Error
Pressure sensor short circuit	Error
Pressure sensor failure/disconnection	Error
Voltage drop of power supply for logic/input	Warning
Valve protection function in use	Warning

Real-time diagnosis (Process data)

- Any event information detected by the SI unit using the process data can be transmitted to the PLC and PC in real time via the upper level Fieldbus.
- 2 types of event flags are transmitted to the PLC and PC. (Error/Warning)

Request base diagnosis (Service data)

- Regarding detailed diagnostic information, the event codes can be transmitted as service data to the PLC and PC.

Data storage function

- The parameters of each ejector can be saved automatically to the IO-Link master.
- When replacing or adding an IO-Link device, the saved parameters can be written automatically, reducing replacement/setup time.

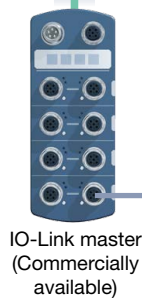

IO-Link

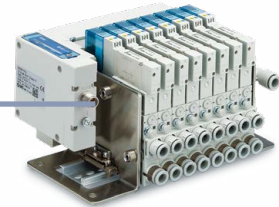

Implement diagnostic bits in the process data.

The diagnostic bit in the cyclic process data makes it easy to find problems with the equipment. It is possible to find problems with the equipment in real time using the cyclic (periodic) data and to monitor such problems in detail with the noncyclic (aperiodic) data.

Process Data

Vacuum manifold stations	Input process data	Output process data
4	4 byte	2 byte
8	5 byte	3 byte
12	6 byte	4 byte
16	7 byte	5 byte

* The process data size occupied by the SI unit depends on the number of vacuum manifold stations.

Input process data

Byte	1								0							
Bit offset	15	14	13	12	11	10	9	8	7	6	5	4	3	2	1	0
Item	Pressure value															
Byte	3								2							
Bit offset	31	30	29	28	27	26	25	24	23	22	21	20	19	18	17	16
Item	CH3 Release confirmation	CH3 Vacuum confirmation	CH2 Release confirmation	CH2 Vacuum confirmation	CH1 Release confirmation	CH1 Vacuum confirmation	CH0 Release confirmation	CH0 Vacuum confirmation	Valve protection	Parameter setting error	Supply valve setting mismatch	Power supply diagnostics for logic/input	Manifold connection error	Pressure sensor failure/disconnection	Pressure sensor short circuit	Valve short circuit
Byte	5								4							
Bit offset	47	46	45	44	43	42	41	40	39	38	37	36	35	34	33	32
Item	CH11 Release confirmation	CH11 Vacuum confirmation	CH10 Release confirmation	CH10 Vacuum confirmation	CH9 Release confirmation	CH9 Vacuum confirmation	CH8 Release confirmation	CH8 Vacuum confirmation	CH7 Release confirmation	CH7 Vacuum confirmation	CH6 Release confirmation	CH6 Vacuum confirmation	CH5 Release confirmation	CH5 Vacuum confirmation	CH4 Release confirmation	CH4 Vacuum confirmation
Byte	6															
Bit offset	55	54	53	52	51	50	49	48								
Item	CH15 Release confirmation	CH15 Vacuum confirmation	CH14 Release confirmation	CH14 Vacuum confirmation	CH13 Release confirmation	CH13 Vacuum confirmation	CH12 Release confirmation	CH12 Vacuum confirmation								

* The pressure value of the monitoring channel selected in the output process data can be checked.

Output process data

Byte	1								0							
Bit offset	15	14	13	12	11	10	9	8	7	6	5	4	3	2	1	0
Item	CH3 Release instruction	CH3 Vacuum instruction	CH2 Release instruction	CH2 Vacuum instruction	CH1 Release instruction	CH1 Vacuum instruction	CH0 Release instruction	CH0 Vacuum instruction	Pressure value monitoring channel selection							
Byte	3								2							
Bit offset	31	30	29	28	27	26	25	24	23	22	21	20	19	18	17	16
Item	CH11 Release instruction	CH11 Vacuum instruction	CH10 Release instruction	CH10 Vacuum instruction	CH9 Release instruction	CH9 Vacuum instruction	CH8 Release instruction	CH8 Vacuum instruction	CH7 Release instruction	CH7 Vacuum instruction	CH6 Release instruction	CH6 Vacuum instruction	CH5 Release instruction	CH5 Vacuum instruction	CH4 Release instruction	CH4 Vacuum instruction
Byte	4															
Bit offset	39	38	37	36	35	34	33	32								
Item	CH15 Release instruction	CH15 Vacuum instruction	CH14 Release instruction	CH14 Vacuum instruction	CH13 Release instruction	CH13 Vacuum instruction	CH12 Release instruction	CH12 Vacuum instruction								

CONTENTS

Vacuum Manifold for Fieldbus System *ZKJ Series*

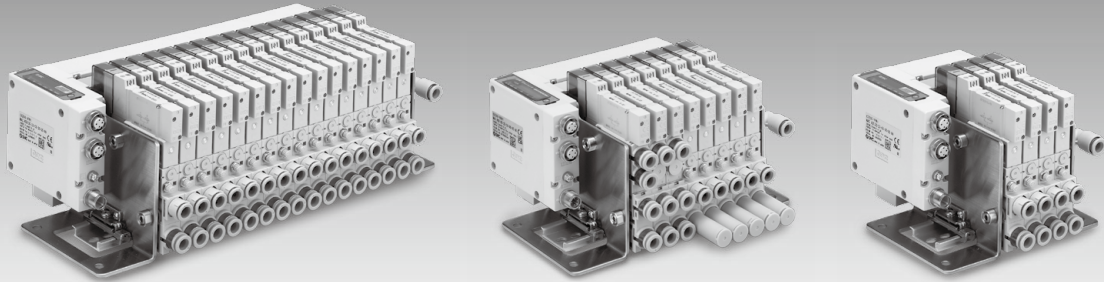

How to Order	p. 11
Specifications	p. 14
Connector/LED Indicator	p. 18
Exhaust Characteristics/Flow Rate Characteristics	p. 19
Vacuum Release Flow Rate Characteristics, How to Read the Flow Rate Characteristics Graph	p. 21
Dimensions	p. 22
Air Circuit Diagram	p. 24
Construction	p. 25
Exploded View of Manifold	p. 26
Manifold Options	p. 27
Accessories	p. 28

Vacuum Manifold for Fieldbus System

ZKJ Series



How to Order (Manifold)

Vacuum manifold **ZZKJ 04 - FAN - L8**

① ② ③

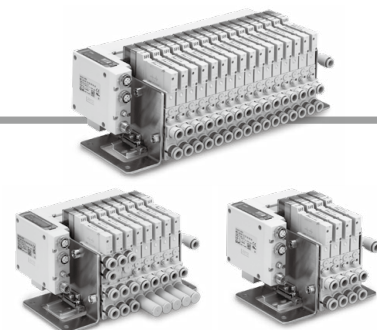

① Manifold stations

Symbol	Manifold stations	Individual unit stations
04	4	Max. 4 stations
08	8	Max. 8 stations
12	12	Max. 12 stations
16	16	Max. 16 stations

- * The product outline is every four stations manifold. Be sure that the total number of vacuum units, positive pressure units, and blanking plates is equal to the manifold stations.
- * The manifold model number cannot be ordered alone.
- * Each blanking plate can be replaced with a vacuum unit/positive pressure unit later in order to increase the number of stations. In addition, the number of stations can be decreased in the same manner for maintenance, etc.

② SI unit specifications

Symbol	Protocol
DAN	EtherCAT
EAN	EtherNet/IP™
FAN	PROFINET
KAN	IO-Link

③ U-side end plate and supply (P) port

Symbol	Supply (P) port
L8	ø8 Elbow One-touch fittings
LN9	ø5/16" Elbow One-touch fittings



Caution

This product cannot be ordered only with the manifold part number. Under the manifold part number, be sure to add the single unit part number (pages 12 and 13) with an asterisk prefix.

Ordering Example

Example 1: Only vacuum units

- When 8 vacuum unit stations are required or when an increase to 9 to 12 units may be required in the future due to a change in application, select the 12-station manifold and order 4 sets of blanking plates.

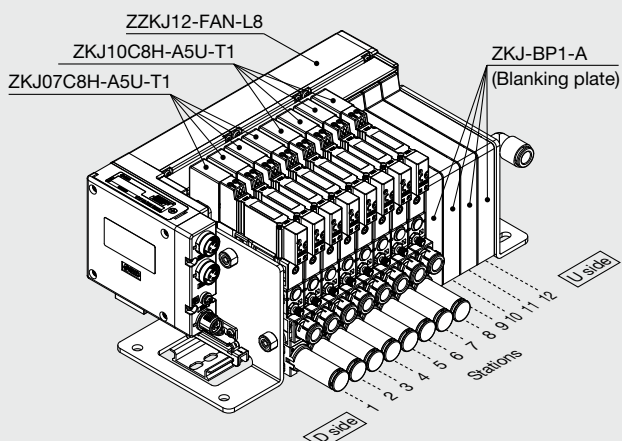

- ZZKJ12-FAN-L8 1 set (Manifold part number)
- * ZKJ07C8H-A5U-T1 4 sets (Vacuum unit)
- * ZKJ10C8H-A5U-T1 4 sets (Vacuum unit)
- * ZKJ-BP1-A 4 sets (Blanking plate)

↳ The asterisk denotes the symbol for the assembly. Prefix to the single unit part number.

Example 2: Mixed vacuum units and positive pressure units

- When 1 positive pressure unit and 2 vacuum units are required, select the 4-station manifold and order 1 set of blanking plates.

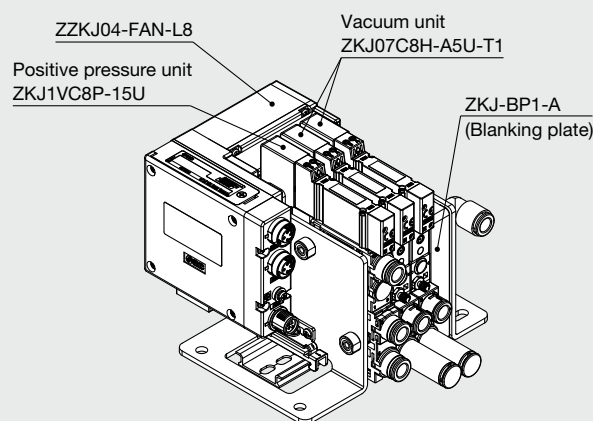

- ZZKJ04-FAN-L8 1 set (Manifold part number)
- * ZKJ1VC8P-15U 1 set (Positive pressure unit)
- * ZKJ07C8H-A5U-T1 2 sets (Vacuum unit)
- * ZKJ-BP1-A 1 set (Blanking plate)

↳ The asterisk denotes the symbol for the assembly. Prefix to the single unit part number.

- When the manifold is viewed from V port, the first station starts from the left (D side).
- After the manifold part number, specify the installed single unit from the first station.
- Please refer to Manifold Options on page 27 for details of the blanking plate.

How to Order (Single unit for manifold)



Vacuum unit (Ejector)

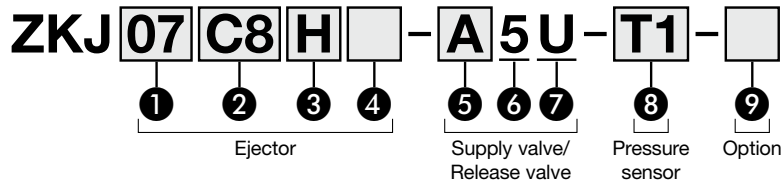

① Nominal nozzle size

Symbol	Nominal nozzle size
07	ø0.7
10	ø1.0
12	ø1.2
15	ø1.5

② Vacuum (V) port, supply (P) port

Symbol	Standard	Vacuum (V) port	Supply (P) port
C6	Metric	ø6	Plug
C8		ø8	
N7	Inch	ø1/4"	
N9		ø5/16"	
C6U	Metric	ø6	ø6*1
C8U		ø8	
N7U	Inch	ø1/4"	ø1/4"*1
N9U		ø5/16"	

*1 Select this option when selecting the plug for individual supply option or when increasing the flow rate from the supply port.

③ Exhaust (EXH) port

Symbol	Exhaust type
H	High-noise reduction silencer exhaust
P	Port exhaust*1

*1 Port size of exhaust port; mm: ø8, inch: ø5/16"

④ Exhaust sealing valve

Symbol	Specification
Nil	None
V	Exhaust sealing valve

* When "15" is selected for the nominal nozzle size, leave the symbol for the exhaust sealing valve blank.

⑤ Combination of supply valve and release valve

Symbol	Supply valve	Release valve
A	N.C.	N.C.
E	N.O.	N.C.

* Check the SI unit supply valve factory settings, and change the SI unit settings in accordance with the selected supply valve.

⑥ Rated voltage

Symbol	Voltage
5	24 VDC

⑦ Light/surge voltage suppressor and common specification

Symbol	With light	Surge voltage suppressor	Common specification
U	Yes	Yes	Non-polar

⑧ Pressure sensor

Symbol	Specifications
T1	-100 to 100 [kPa]
T2	-100 to 200 [kPa]

* When "Nil" is selected for ④ exhaust sealing valve, T1 is required. When "V" is selected, T2 is required.

* The SI unit pressure sensor is set to T1 (-100 to 100 [kPa]) at the time of shipment. Change the SI unit settings in accordance with the specifications of the selected pressure sensor.

⑨ Option*1

Symbol	Type
Nil	Without option
E	Vacuum release flow adjusting needle screwdriver operation type long lock nut
M	Plug for individual supply*2, *3 (Blocking the air supply passage to the D side)
R	With manual override for residual pressure release*4
Y	Vacuum (V) port release to atmosphere type (Check valve: 1 pc.)*5

*1 When more than one option is selected, list the option symbols in alphabetical order. (Example -EM)

*2 The supply (P) port for vacuum manifold is mounted only on the U side.

When a vacuum unit/positive pressure unit with a built-in plug for individual supply is selected, be sure to select a supply (P) port via ② for the unit immediately to the D side of the aforementioned unit.

For detail, refer to "Manifold Options" on page 27.

*3 The plug for individual supply is mounted on the first station to block the air supply passage to the D side. Option M can be selected after second station.

*4 Manual override to release vacuum (V) port to atmosphere. When option R is selected, option Y cannot be used together.

*5 When "Y" is selected, the energy saving function is not available. When the vacuum generation is stopped, the vacuum (V) port is released to the atmosphere.

* When option Y is selected, "V" for ④ exhaust sealing valve cannot be selected.

How to Order (Single unit for manifold)



Positive pressure unit (5-port valve) **ZKJ 1V C6 P-1 5U-**

1
2
3
4
5
6
7

1 Unit specifications

Symbol	Type
1V	Positive pressure unit

* When using a positive pressure unit with the initial SI unit settings, diagnostic information for pressure sensor disconnection will be issued. Therefore, be sure to change the SI unit settings in accordance with the selected individual unit.

2 Output A(4), B(2) port, supply P(1) port

Symbol	Standard	Output (A, B) port	Supply (P) port
C6	Metric	ø6	Plug
C8		ø8	
N7		ø1/4"	
N9	Inch	ø5/16"	
C6U	Metric	ø6	ø6*1
C8U		ø8	ø8*1
N7U	Inch	ø1/4"	ø1/4"*1
N9U		ø5/16"	ø5/16"*1

*1 Select this option when selecting the plug for individual supply option or when increasing the flow rate from the supply port.

3 Exhaust E(3/5) port

Symbol	Exhaust type
P	Port exhaust*1

*1 Port size of exhaust port; mm: ø8, inch: ø5/16"

4 Type of actuation

Symbol	Specifications	
1	2-position	Single
2		Double
A	4-position dual 3-port	N.C./N.C.

5 Rated voltage

Symbol	Voltage
5	24 VDC

6 Light/surge voltage suppressor and common specification

Symbol	With light	Surge voltage suppressor	Common specification
U	Yes	Yes	Non-polar

7 Option

Symbol	Specifications
Nil	Without option
M	Plug for individual supply*1, *2 (Blocking the air supply passage to the D side)

*1 The supply (P) port for vacuum manifold is mounted only on the U side.

When a vacuum unit/positive pressure unit with a built-in plug for individual supply is selected, be sure to select a supply (P) port via 2 for the unit immediately to the D side of the aforementioned unit.

*2 Station 1 cannot be selected as it has a built-in plug for individual supply to prevent air from passing to the D side.

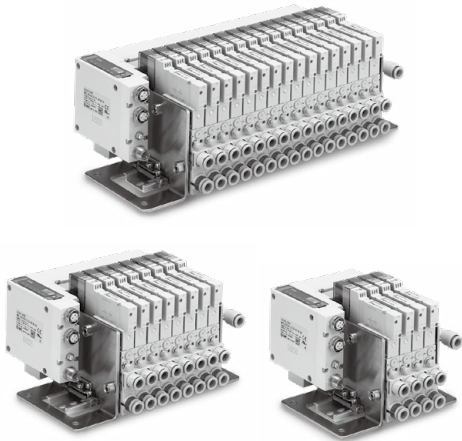

Specifications

Vacuum Unit*1

Model		ZKJ07	ZKJ10	ZKJ12	ZKJ15	
Fluid		Air				
Nozzle size [mm]		0.7	1.0	1.2	1.5	
Standard supply pressure [MPa]		0.4				
Max. vacuum pressure [kPa]*2		-89				
Max. suction flow rate [L/min (ANR)]*2, *3	Port exhaust	Without exhaust sealing valve	31	53	63	74
		With exhaust sealing valve	30	48	57	—
	High-noise reduction silencer exhaust	Without exhaust sealing valve	31	51	60	68
		With exhaust sealing valve	30	45	54	—
Air consumption [L/min (ANR)]*2		26	48	68	102	
Supply pressure range [MPa]		0.3 to 0.5				
Type of actuation		Supply valve: N.C., Release valve: N.C. (ZKJ-JSY3A) Supply valve: N.O., Release valve: N.C. (ZKJ-JSY3E)				
Response time (at 0.5 MPa)*4		23 ms or less				
Max. operating frequency		3 Hz				
Manual override		Non-locking push type				
Power consumption		0.4 W				
Environmental resistance	Operating temperature range		0 to 50°C (No condensation)			
	Vibration resistance*5		30 m/s ²			
	Impact resistance*6		150 m/s ²			
	Withstand voltage		500 VAC for 1 minute between terminals and FE			
	Insulation resistance		500 VDC, 10 MΩ or more between terminals and FE			
Enclosure*7		IP65				
Standards		CE/UKCA marking (EMC directive/RoHS directive)				

* The solenoid valve mounted on this product is equivalent to the SMC JSY3000 series 5-port solenoid valve.

For details on solenoid valve functions, refer to the Operation Manual of the JSY3000 series on the SMC website (<https://www.smcworld.com>).

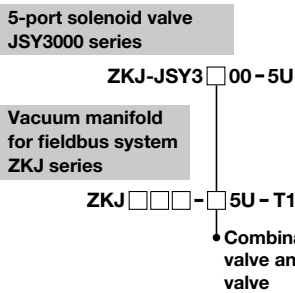

*1 The supply valve and release valve mounted on this product is the SMC dual 3-port valve JSY3000 series. Refer to the **Web Catalog** for details on the JSY3000 series.

*2 Values are at the standard supply pressure and based on SMC's measurement standards. They depend on atmospheric pressure (weather, altitude, etc.) and the measurement method.

*3 If the vacuum port diameter is $\phi 6$ or $\phi 1/4$ ", Max. Suction flow rate is reduced by 15% or less.

*4 It shows supply valve/release valve specification. Based on dynamic performance test, JIS B 8419:2010. (Coil temperature: 20°C, at rated voltage)

*5 The characteristics are satisfied when tested for 2 hours in each of the X, Y and Z directions at 10 to 500 Hz without energization. (Initial value)

*6 The characteristics are satisfied when tested one time in each of the X, Y and Z directions without energization. (Initial value)

*7 Cannot be used in an environment where oil such as cutting oil splashes or it is constantly exposed to water
Take appropriate protective measures.

Positive pressure unit

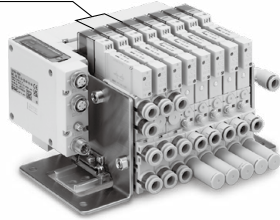

Specifications

Positive Pressure Unit

Model		ZKJ1V□P-15U	ZKJ1V□P-25U	ZKJ1V□P-A5U
Fluid		Air		
Supply pressure range [MPa]		0.3 to 0.5		
Type of actuation		2-position single	2-position double	4-position dual 3-port valve (N.C./N.C.)
Response time*1		18 ms or less	12 ms or less	23 ms or less
Max. operating frequency		5 Hz		
Manual override		Non-locking push type		
Power consumption		0.4 W		
Environmental resistance	Operating temperature range	0 to 50°C (No condensation)		
	Vibration resistance*2	30 m/s ²		
	Impact resistance*3	150 m/s ²		
	Withstand voltage	500 VAC for 1 minute between terminals and FE		
	Insulation resistance	500 VDC, 10 MΩ or more between terminals and FE		
Enclosure*4		IP65		
Standards		CE/UKCA marking (EMC directive/RoHS directive)		

*1 It shows solenoid valve specification. Based on dynamic performance test, JIS B 8419:2010. (Coil temperature: 20°C, at rated voltage)

*2 The characteristics are satisfied when tested for 2 hours in each of the X, Y and Z directions at 10 to 500 Hz without energization. (Initial value)

*3 The characteristics are satisfied when tested one time in each of the X, Y and Z directions without energization. (Initial value)

*4 Cannot be used in an environment where oil such as cutting oil splashes or it is constantly exposed to water
Take appropriate protective measures.

Positive Pressure Unit: Flow Rate Characteristics

Model	Port size		1 → 4/2 (P → A/B)		4/2 → 3/5 (A/B → E)			
	1, 3/5 (P, E)	4, 2 (A, B)	C [dm ³ /(s·bar)]	b	C [dm ³ /(s·bar)]	b		
ZKJ1VC6P-15U	C8	C6	1.33	0.38	1.44	0.39		
ZKJ1VC6P-25U			1.07	0.34	1.40	0.46		
ZKJ1VC6P-A5U		C8	C8	1.46	0.46	1.44	0.28	
ZKJ1VC8P-15U				1.15	0.41	1.40	0.32	
ZKJ1VC8P-25U								
ZKJ1VC8P-A5U								

* Calculation of effective area "S" and sonic conductance "C": S = 5.0 x C
Values measured in accordance with ISO 6358:1989, JIS B 8390:2000

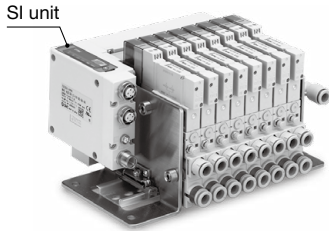

Specifications

Max. Number of Manifold Stations that Can Operate Simultaneously*1

Model	ZKJ07	ZKJ10	ZKJ12	ZKJ15
Air supply port: 1 port · U-side end plate P port (ø8)	16	6	5	3
Air supply port: 2 ports · U-side end plate P port (ø8), Equipped with 1 vacuum unit with a P port (ø6)	16	8	7	4

*1 Values are the number of stations that can be generated vacuum simultaneously.

Noise Level (Reference values)

Model	ZKJ07	ZKJ10	ZKJ12	ZKJ15
Noise level [dB(A)]	52	63	67	71

* Values are at the standard supply pressure.

* Values are with 1 vacuum unit generating vacuum pressure adequately for adsorption with high-noise reduction silencer. (Not guaranteed values)

Weight

Manifold stations (All vacuum units)	4 stations	8 stations	12 stations	16 stations
Weight [kg]	1.7	2.5	3.3	4.1

* When the blanking plate is mounted, please subtract 0.1 [kg] per unit.

SI Unit (PROFINET) (For details, refer to the Operation Manual.)

Model			EX260-VPN1
Electrical	Power supply for control/ input	Power supply voltage	24 VDC ±10%
		Internal current consumption	100 mA or less
	Power supply for output	Power supply voltage	24 VDC +10%, -5%
Communication	Protocol		PROFINET
	Device type		PROFINET IO
	Configuration file*1		GSD File
	Version		PROFINET Specification Version 2.3
	Communication speed		100 Mbps full duplex
	Applicable function		MRP function MRPD function Fast Start Up function Shared Device function Conformance Class C Net Load Class III
Vacuum	Applicable function		Energy saving Valve protection Zero-clear function

*1 The configuration file can be downloaded from the SMC website: <https://www.smcworld.com>

SI Unit (EtherNet/IP™) (For details, refer to the Operation Manual.)

Model			EX260-VEN1
Electrical	Power supply for control/ input	Power supply voltage	24 VDC ±10%
		Internal current consumption	100 mA or less
	Power supply for output	Power supply voltage	24 VDC +10%, -5%
Communication	Protocol		EtherNet/IP™
	Device type		2Bh (Generic Device)
	Configuration file*1		EDS File
	Conformance test revision		CT18
	Communication speed		10 M/100 Mbps
	Applicable function		DLR function QuickConnect™ function Web server function
Vacuum	Applicable function		Energy saving Valve protection Zero-clear function

*1 The configuration file can be downloaded from the SMC website: <https://www.smcworld.com>

Specifications

SI Unit (IO-Link) (For details, refer to the Operation Manual.)

Model			EX260-VIL1
Electrical	Power supply for control/ input	Power supply voltage	24 VDC ±10%
		Internal current consumption	100 mA or less
	Power supply for output	Power supply voltage	24 VDC +10%, -5%
Communication	Protocol		IO-Link
	IO-Link type		Device
	Port class		Class B
	Configuration file*1		IODD File
	Version		V1.1
	Communication speed		COM2 (38.4 kbps)
Vacuum	Applicable function		ISDU Data Storage
	Applicable function		Energy saving Valve protection Zero-clear function

*1 The configuration file can be downloaded from the SMC website: <https://www.smcworld.com>

SI Unit (EtherCAT) (For details, refer to the Operation Manual.)

Model			EX260-VEC1
Electrical	Power supply for control/ input	Power supply voltage	24 VDC ±10%
		Internal current consumption	100 mA or less
	Power supply for output	Power supply voltage	24 VDC +10%, -5%
Communication	Protocol		EtherCAT
	Configuration file*1		ESI File
	Version		Conformance Test Record V2.3.0
	Communication speed		100 Mbps
	Applicable function		CoE FoE
Vacuum	Applicable function		Energy saving Valve protection Zero-clear function

*1 The configuration file can be downloaded from the SMC website: <https://www.smcworld.com>

Control Unit Specifications

Model		ZKJ-S004-A	ZKJ-S008-A	ZKJ-S012-A	ZKJ-S016-A
Station		4	8	12	16
Input	Pressure sensor	4	8	12	16
	Pressure sensor short circuit detection/Protection circuit	Built-in (Common detection/protection)			
Output	Number of valve outputs	8	16	24	32
	Valve short circuit detection/Protection circuit	Built-in (Individual detection/protection)			

Pressure Sensor Specifications

(For details, refer to the PSE54□ series in the **Web Catalog**, and the Operation Manual.)

Item		Specifications
Rated pressure range	Without exhaust sealing valve	-100 to 100 [kPa]
	With exhaust sealing valve	-100 to 200 [kPa]
Withstand pressure*1		500 [kPa]
Accuracy		±3% F.S.
Current consumption		15 mA or less
Sensor pressure receiving area		Silicon

*1 Do not use the product to drive an actuator such as a cylinder (when release pressure is constantly applied).

Connector/LED Indicator

Part no.	EX260-VPN1	EX260-VEN1
Protocol	PROFINET	EtherNet/IP™
Communication connector (M12) BUS OUT	4-pin, Socket, D-coded	4-pin, Socket, D-coded
Communication connector (M12) BUS IN	4-pin, Socket, D-coded	4-pin, Socket, D-coded
Ground terminal	M3	M3
Power supply connector (M12)	4-pin, Plug, A-coded	4-pin, Plug, A-coded

EX260-VPN1

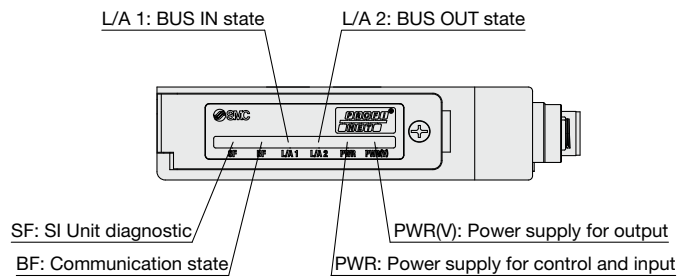

EX260-VEN1

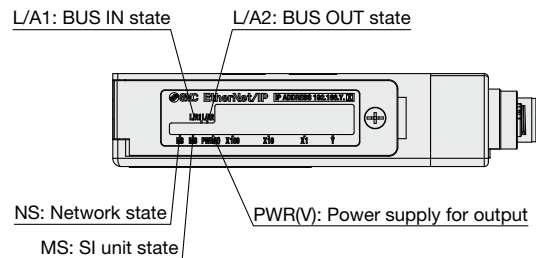

Part no.	EX260-VIL1
Protocol	IO-Link
Communication/Power connector (M12)*1	5-pin, Plug, A-coded
Ground terminal	M3

*1 The communication line, Power supply for control and input line, and the power supply for output line are connected using the same cable.

EX260-VIL1

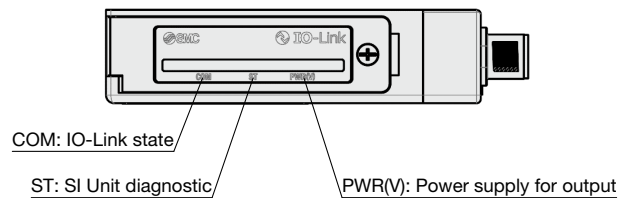

Part no.	EX260-VEC1
Protocol	EtherCAT
Communication connector (M8) ECAT IN	4-pin, Socket, A-coded
Communication connector (M8) ECAT OUT	4-pin, Socket, A-coded
Ground terminal	M3
Power supply connector (M8) PWR IN	4-pin, Plug, A-coded
Power supply connector (M8) PWR OUT	4-pin, Socket, A-coded

EX260-VEC1

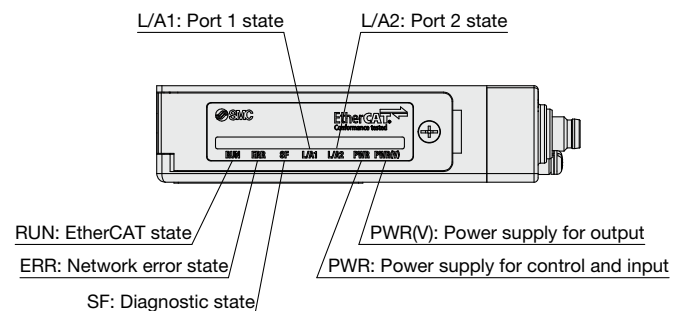

* Values are based on standard of SMC measurements. They depend on atmospheric pressure (weather, altitude, etc.) and measurement method.
 * The flow rate characteristics correspond to the standard supply pressure.

Exhaust Characteristics/Flow Rate Characteristics (Representative value)

ZKJ07

Exhaust Characteristics

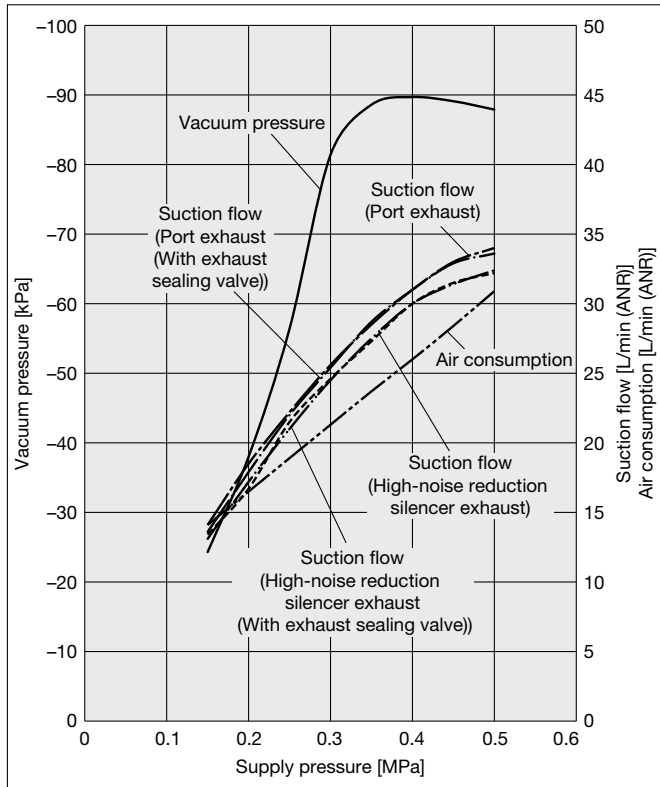

Flow Rate Characteristics

Supply pressure: 0.4 MPa
(Standard supply pressure)

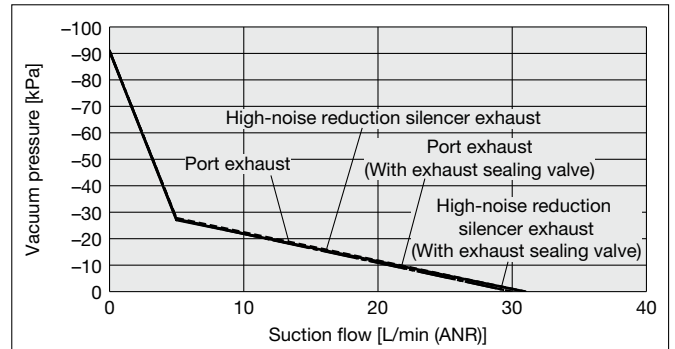

* Port exhaust: V port ø8, no exhaust port piping

ZKJ10

Exhaust Characteristics

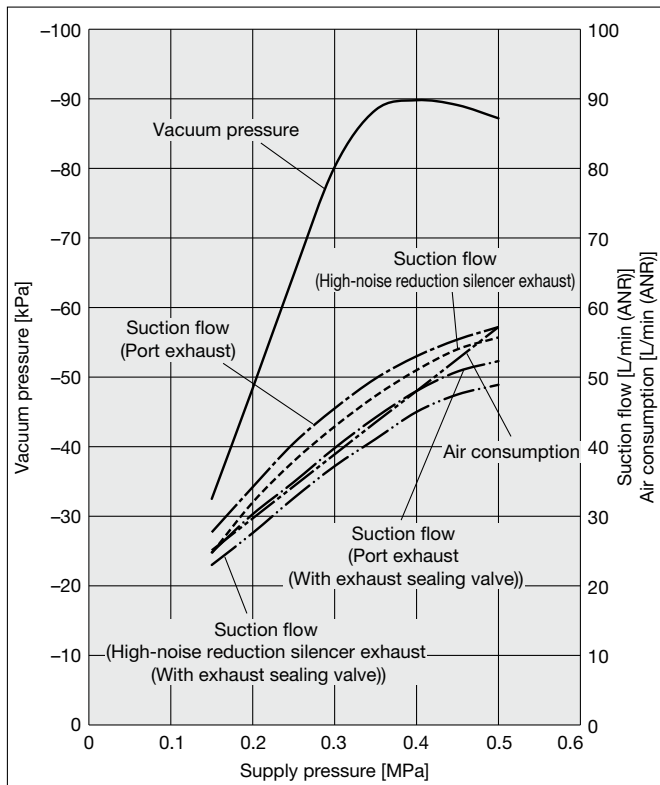

Flow Rate Characteristics

Supply pressure: 0.4 MPa
(Standard supply pressure)

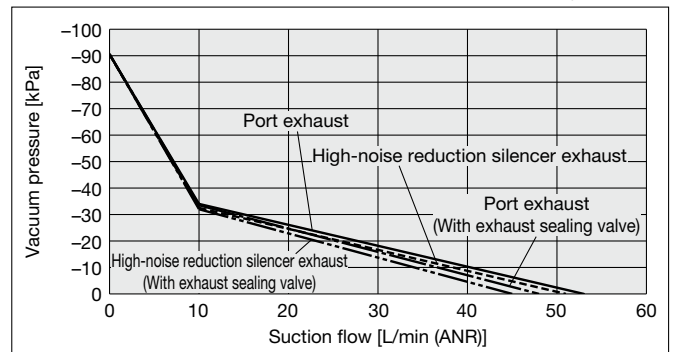

* Port exhaust: V port ø8, no exhaust port piping

* Values are based on standard of SMC measurements. They depend on atmospheric pressure (weather, altitude, etc.) and measurement method.
 * The flow rate characteristics correspond to the standard supply pressure.

Exhaust Characteristics/Flow Rate Characteristics (Representative value)

ZKJ12

Exhaust Characteristics

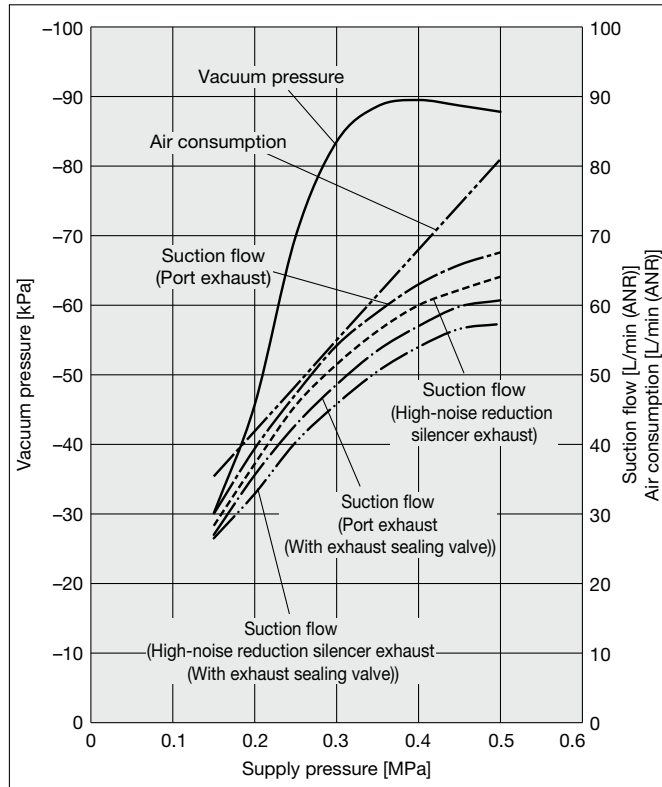

Flow Rate Characteristics

Supply pressure: 0.4 MPa
(Standard supply pressure)

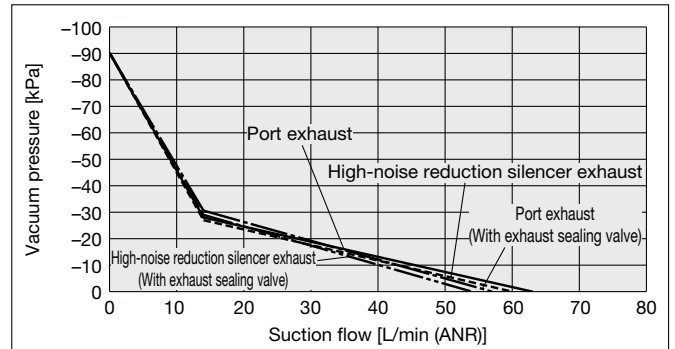

* Port exhaust: V port ø8, no exhaust port piping

ZKJ15

Exhaust Characteristics

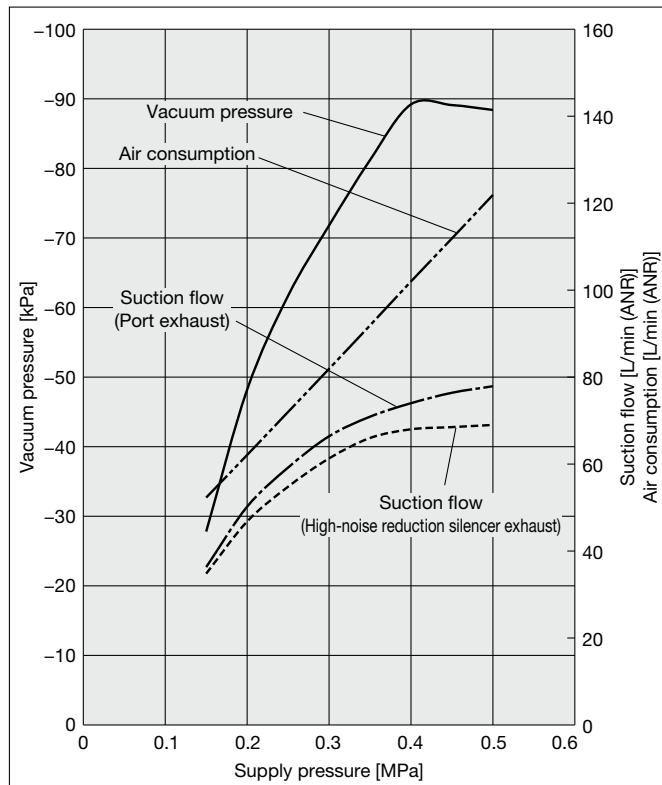

Flow Rate Characteristics

Supply pressure: 0.4 MPa
(Standard supply pressure)

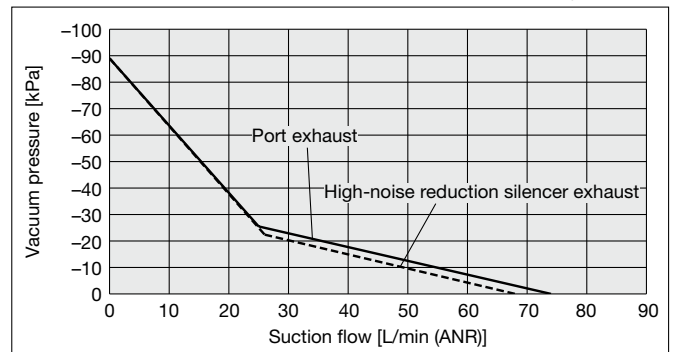

* Port exhaust: V port ø8, no exhaust port piping

Vacuum Release Flow Rate Characteristics (Representative value)

The graph shows the flow rate characteristics at different supply pressures when the vacuum release flow adjusting needle is open from the fully closed state. The actual suction flow at the point of suction varies depending on the piping conditions.

Without exhaust sealing valve/Nozzle size: $\phi 0.7$

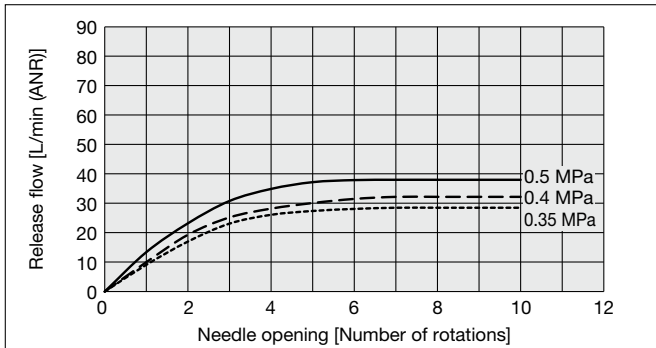

With exhaust sealing valve/Nozzle size: $\phi 0.7$

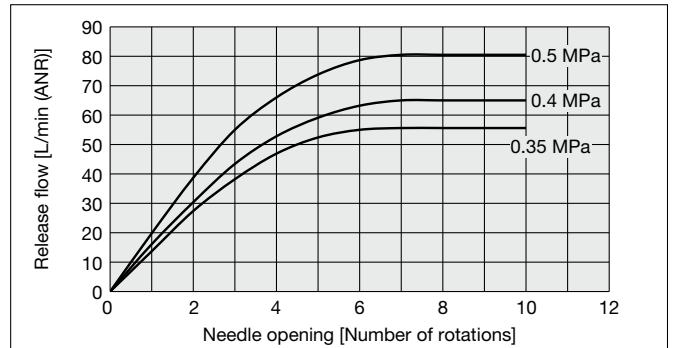

How to Read the Flow Rate Characteristics Graph

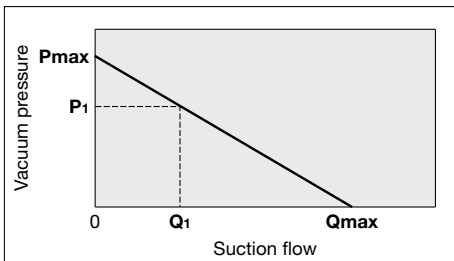

The flow rate characteristics indicate the relationship between the vacuum pressure and the suction flow of the ejector. They also show that when the suction flow changes, the vacuum pressure also changes. In general, this indicates the relationship at the ejector's standard operating pressure.

In the graph, **Pmax** indicates the max. vacuum pressure, and **Qmax** indicates the max. suction flow. These are the values that are published as specifications in catalogs, etc. Changes in vacuum pressure are explained in the order below.

1. If the ejector's suction port is closed and sealed tight, the suction flow becomes "0," and the vacuum pressure increases to the max. (**Pmax**).
2. If the suction port is opened gradually and air is allowed to flow (the air leaks), the suction flow increases, and the vacuum pressure decreases. (The condition of **P1** and **Q1**)
3. If the suction port is opened completely, the suction flow increases to the max. (**Qmax**), while the vacuum pressure then drops almost to "0" (atmospheric pressure).

As described above, the vacuum pressure changes when the suction flow changes. In other words, when there is no leakage from the vacuum (V) port, the vacuum pressure can reach its maximum, but as the amount of leakage increases, the vacuum pressure decreases. When the amount of leakage and the maximum suction flow become equal, the vacuum pressure becomes almost zero. When adsorbing workpieces which are permeable, subject to leakage, etc., caution is required as the vacuum pressure will not be very high.

Vacuum Manifold for Fieldbus System **ZKJ Series**

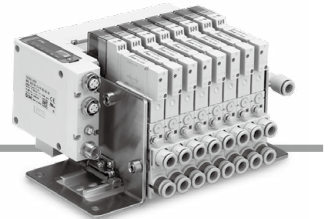

Dimensions

Vacuum unit: ZZKJ□-□-□

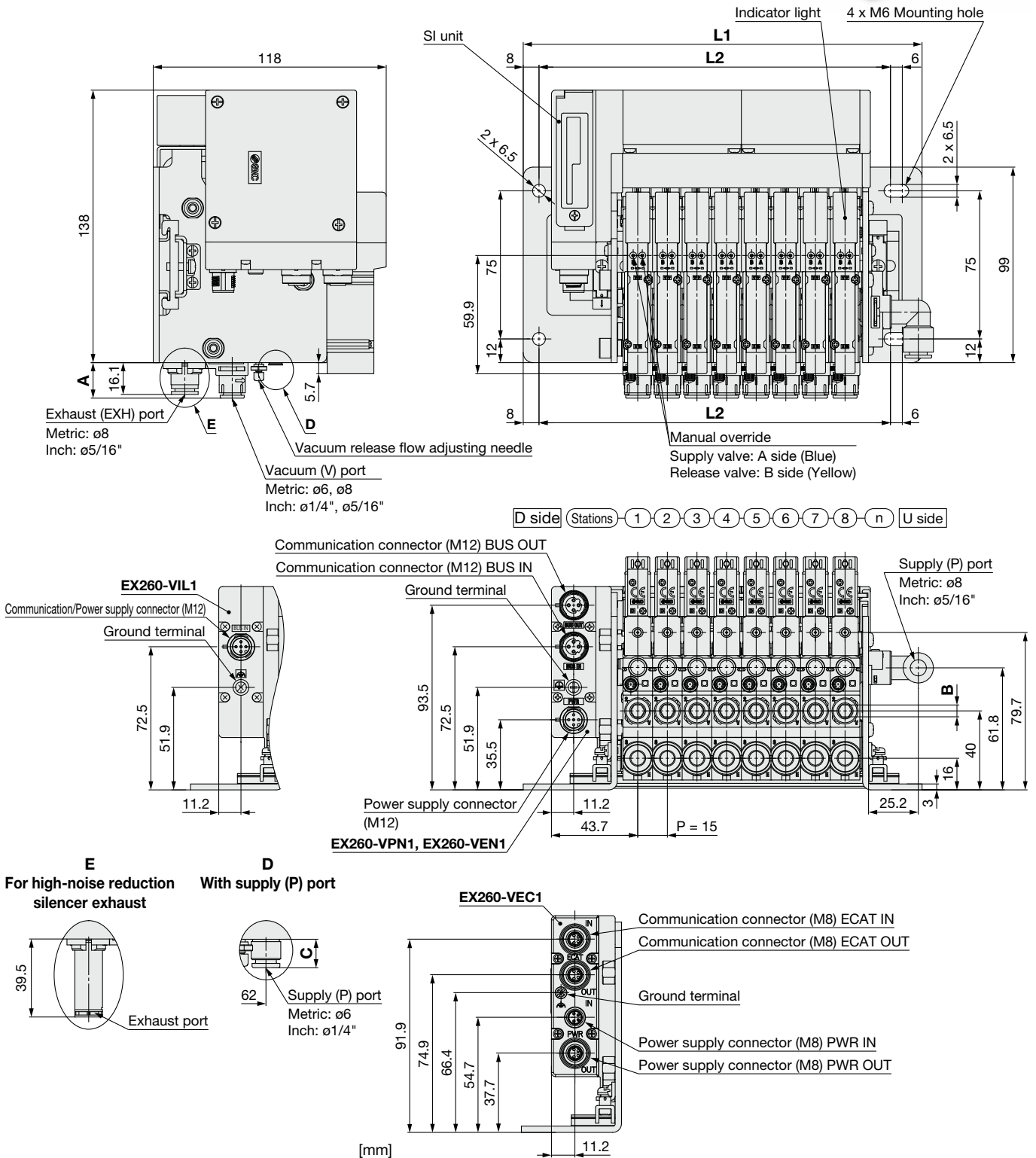

[mm]

Manifold stations		4	8	12	16
L1		142	202	262	322
L2		118	178	238	298
Port type		A	Hexagon width across flats B		C
Metric	C6	ø6	14.8	4	9.7
	C8	ø8	18	6	—
Inch	N7	ø1/4"	16.3	4.76	12.3
	N9	ø5/16"	18	6	—

ZKJ Series

Dimensions

Positive pressure unit: ZKJ□-□-□

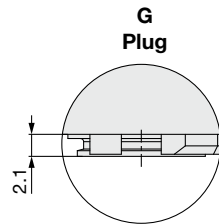
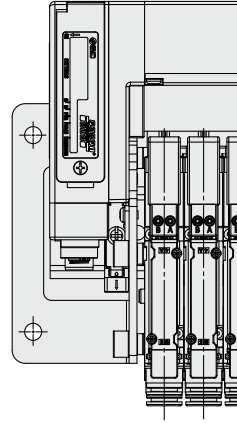
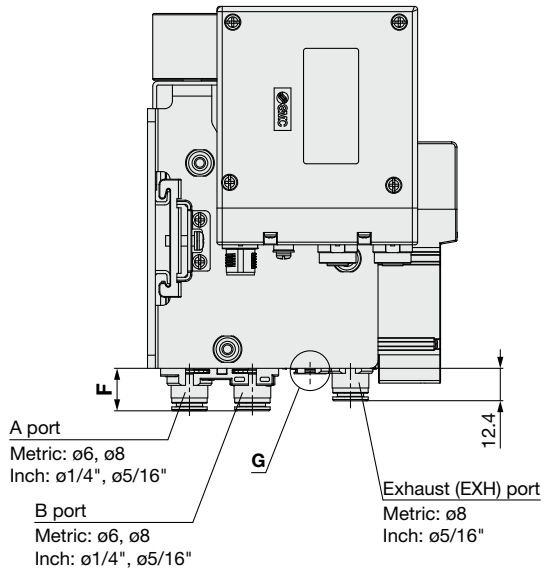
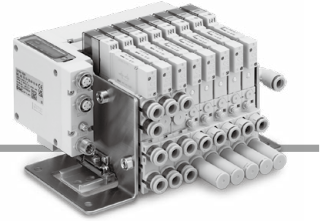

With supply (P) port

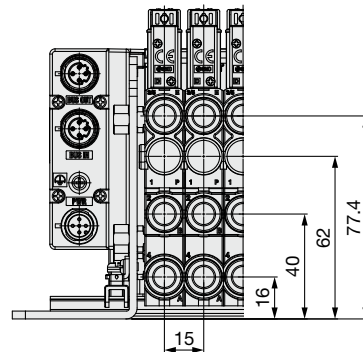
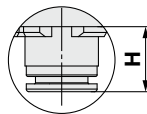

		[mm]	
Port type		F	H
Metric	C6	$\phi 6$	14.5
	C8	$\phi 8$	16.2
Inch	N7	$\phi 1/4$ "	14.5
	N9	$\phi 5/16$ "	16.2

Air Circuit Diagram

Vacuum unit

Without exhaust sealing valve

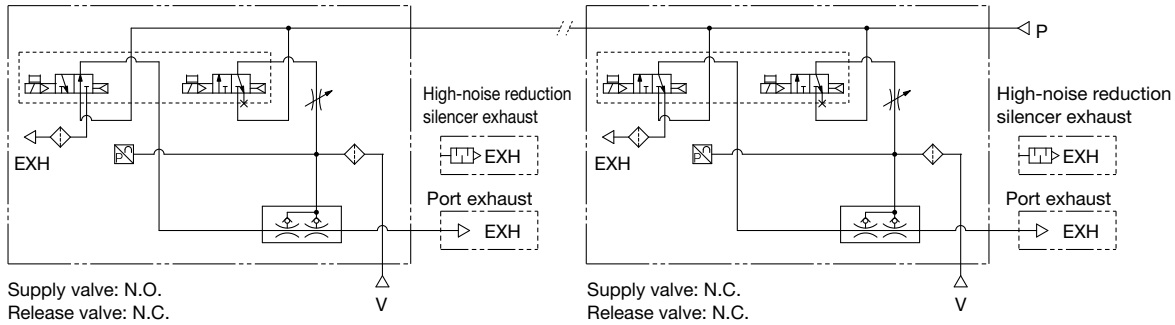

Without exhaust sealing valve/With manual override for residual pressure release

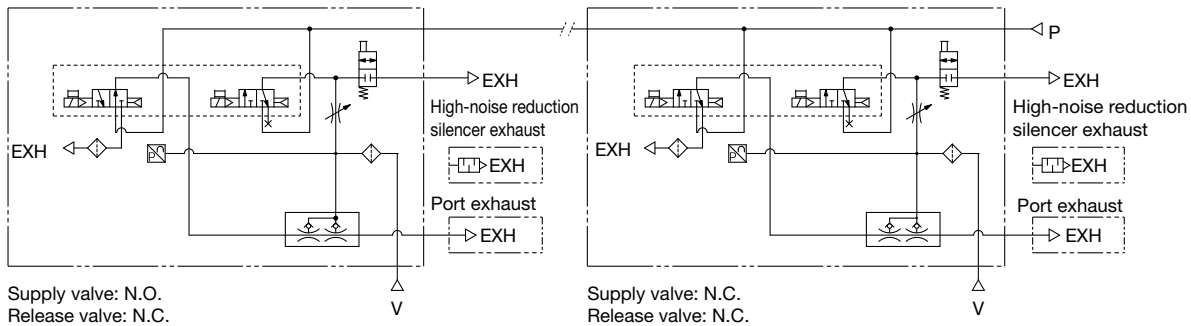

With exhaust sealing valve

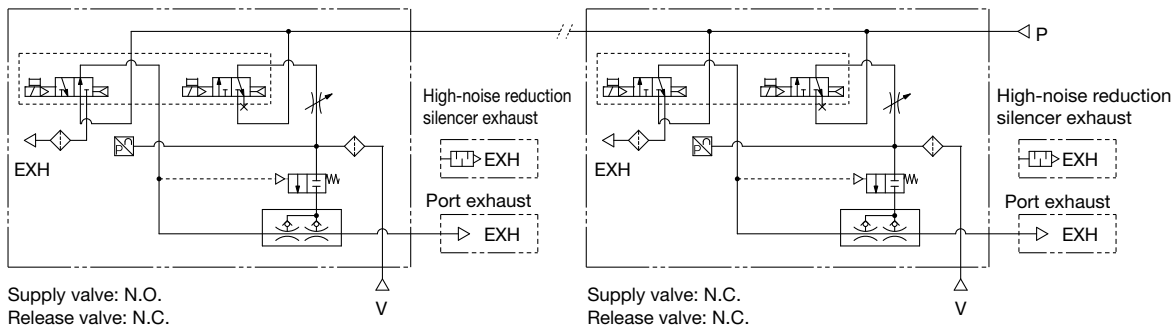

Positive pressure unit

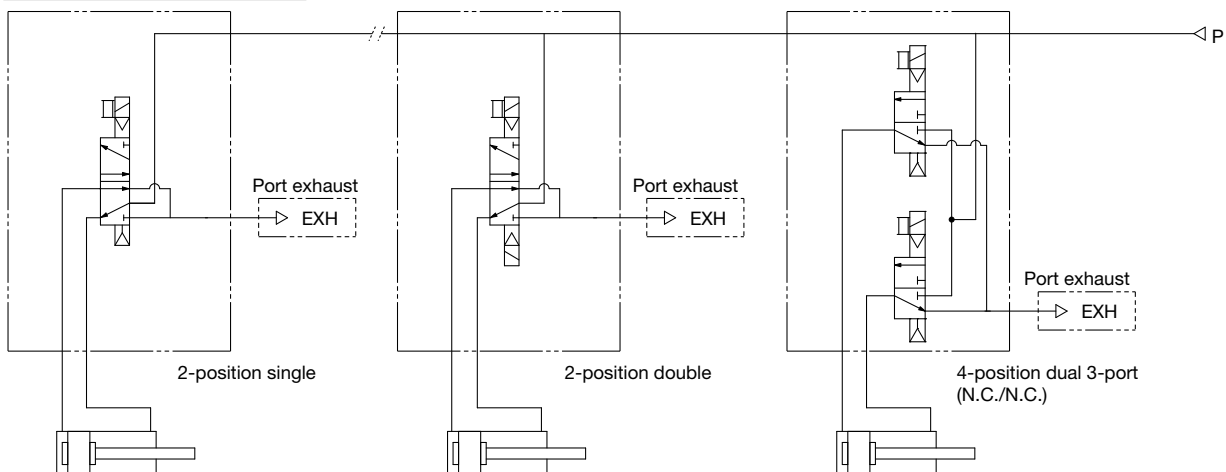

Construction

Vacuum unit

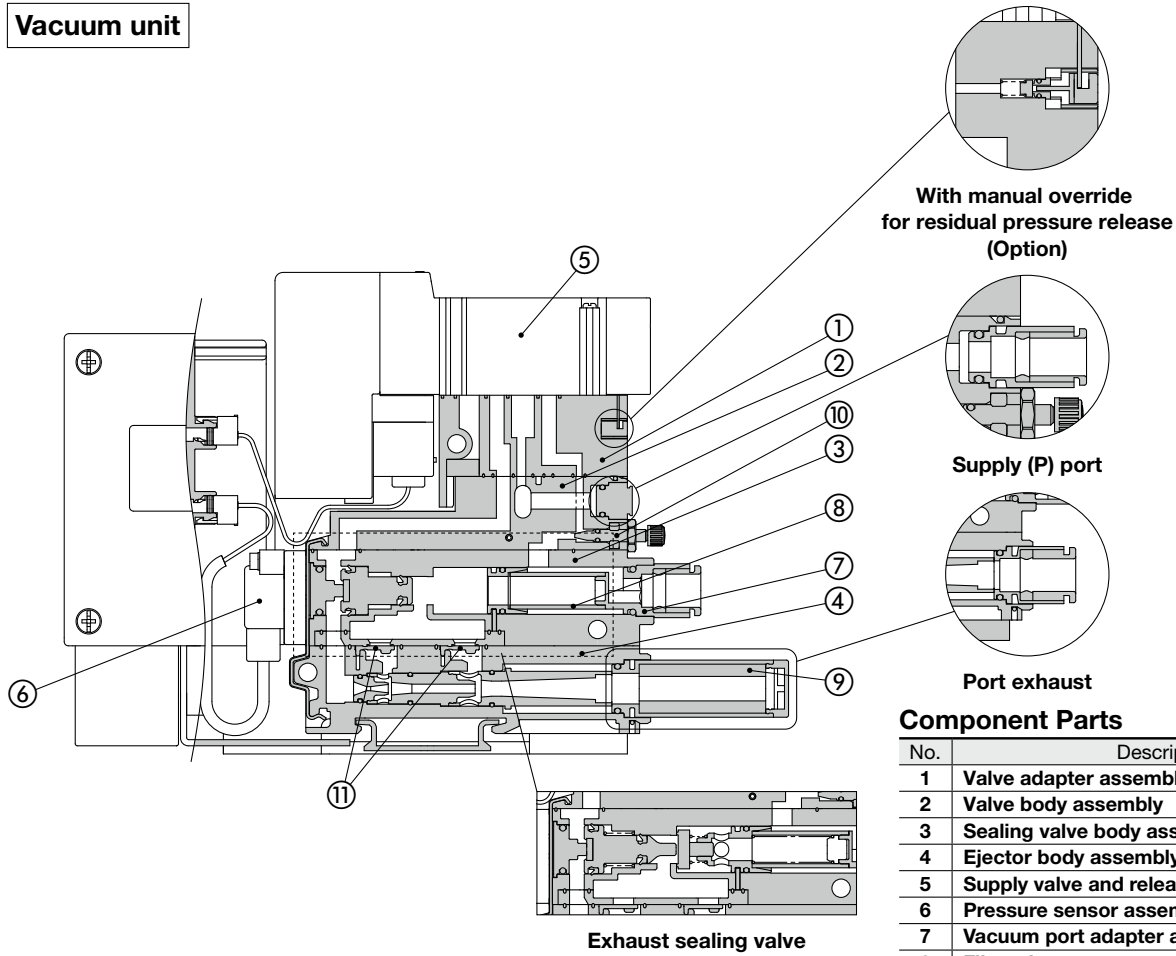

Component Parts

No.	Description
1	Valve adapter assembly
2	Valve body assembly
3	Sealing valve body assembly
4	Ejector body assembly
5	Supply valve and release valve assembly
6	Pressure sensor assembly
7	Vacuum port adapter assembly
8	Filter element
9	High-noise reduction silencer assembly
10	Needle assembly
11	Check valve

* Refer to the operation manual for replacement part part numbers and replacement instructions.

Positive pressure unit

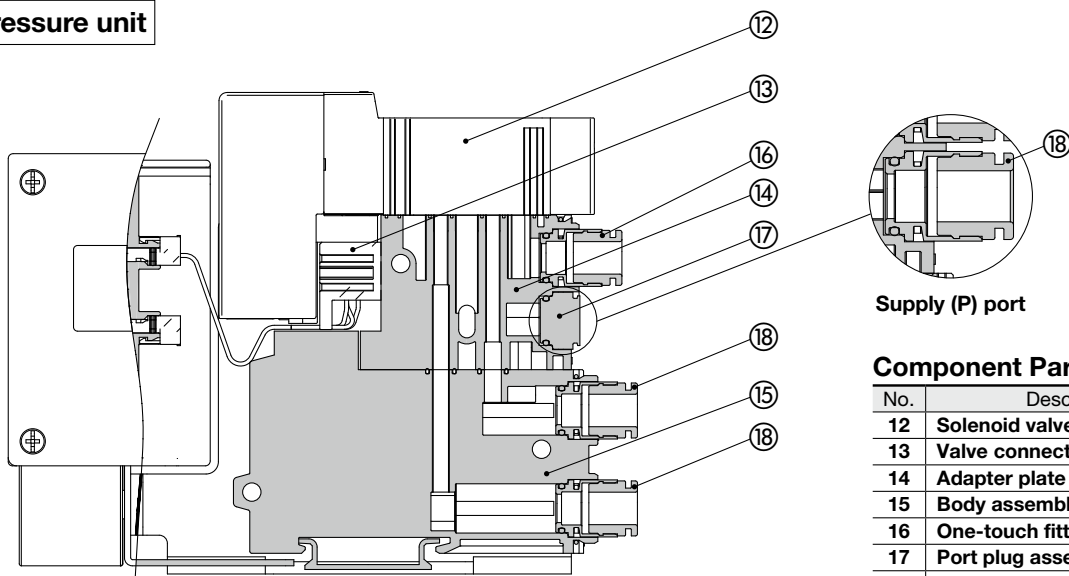

Component Parts

No.	Description
12	Solenoid valve assembly
13	Valve connector assembly
14	Adapter plate assembly
15	Body assembly
16	One-touch fitting assembly
17	Port plug assembly
18	One-touch fitting assembly

* Refer to the operation manual for replacement part part numbers and replacement instructions.

Exploded View of Manifold

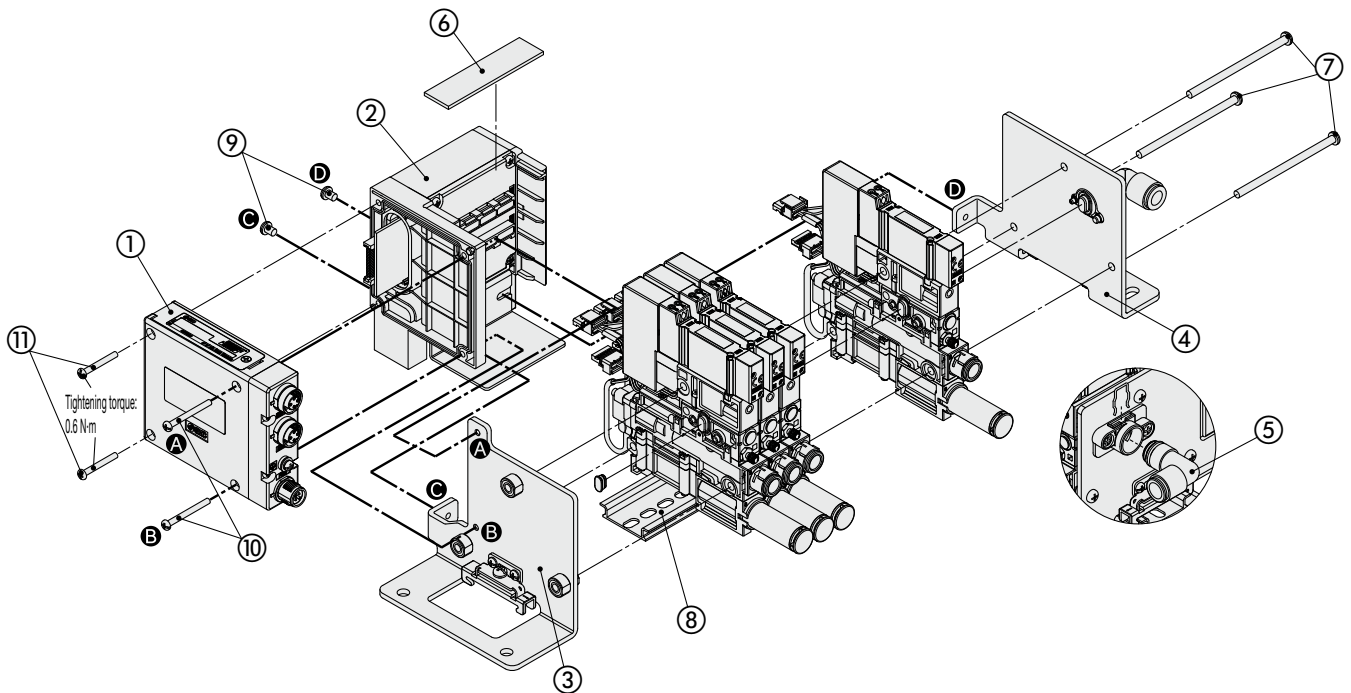

Component Parts

No.	Description	No.	Description
1	SI unit	6	Protection plate
2	Control unit	7	Tension bolt
3	D-side end plate assembly	8	DIN rail
4	U-side end plate assembly	9	Round head combination screw
5	Elbow type One-touch fitting assembly	10	Round head combination screw
		11	Round head combination screw

* Refer to the operation manual for replacement part part numbers and replacement instructions.

ZKJ Series Manifold Options

Manifold Options

■ Blanking plate

[With two connector plug assembly]

For use on unused manifold stations where a vacuum unit/positive pressure unit is not mounted

- * When using a blanking plate with the initial SI unit settings, diagnostic information for pressure sensor disconnection will be issued. Therefore, be sure to change the SI unit settings in accordance with the selected individual unit.

ZKJ - BP1 - A

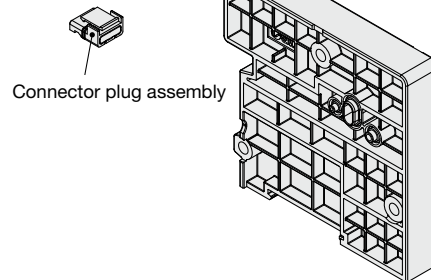

■ Plug for individual supply

By placing "Plug for individual supply" in an ejector manifold's pressure supply passage, two different pressures can be supplied to one manifold.

The supply (P) port for vacuum manifold is mounted only on the U side. When a vacuum unit/positive pressure unit with a built-in plug for individual supply is selected, be sure to select a supply (P) port for the model number of the unit immediately to the D side of the aforementioned unit.

ZK2 - MP2F - A

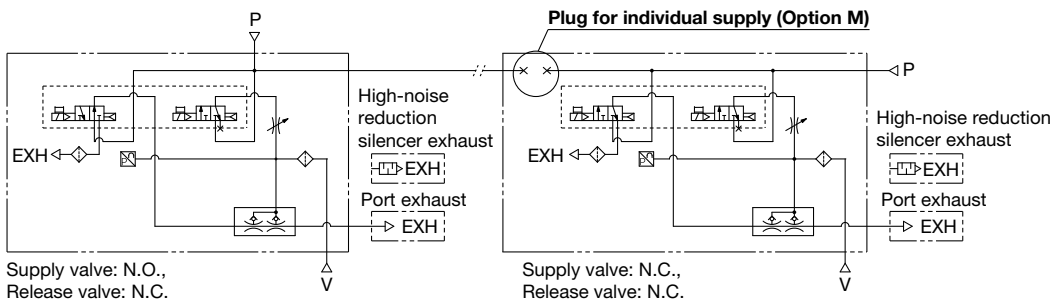
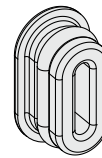

ZKJ Series Accessories

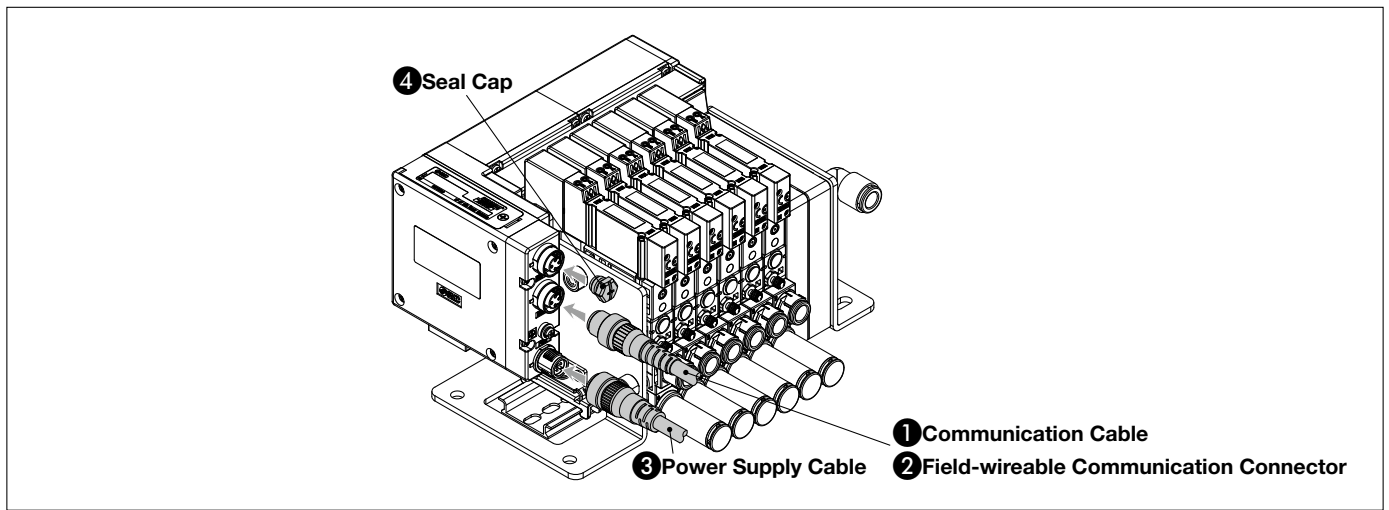

* SMC does not provide communication cables or power cables (M8 connector) for the EtherCAT compatible type. Order a cable from another cable manufacturer.

1 Communication Cable

For PROFINET For EtherNet/IP™

EX9-AC 005 EN-PSPS (With connector on both sides (Plug/Plug))

• Cable length (L)

005	500 mm
010	1000 mm
020	2000 mm
030	3000 mm
050	5000 mm
100	10000 mm

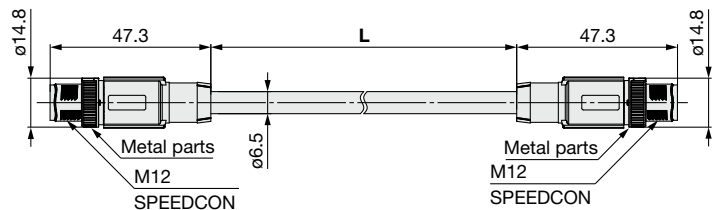

Item	Specifications
Cable O.D.	ø6.5 mm
Conductor nominal cross section	0.34 mm ² /AWG22
Wire O.D. (Including insulator)	1.55 mm
Min. bending radius (Fixed)	19.5 mm

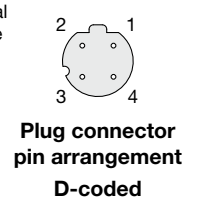
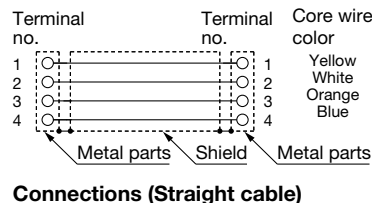
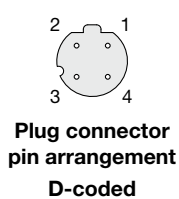

EX9-AC 005 EN-PAPA (With angled connector on both sides (Plug/Plug))

• Cable length (L)

005	500 mm
010	1000 mm
020	2000 mm
030	3000 mm
050	5000 mm
100	10000 mm

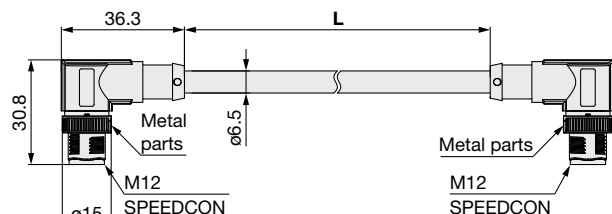

Item	Specifications
Cable O.D.	ø6.5 mm
Conductor nominal cross section	0.34 mm ² /AWG22
Wire O.D. (Including insulator)	1.55 mm
Min. bending radius (Fixed)	19.5 mm

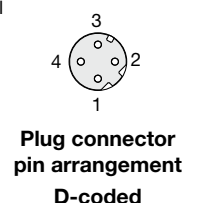
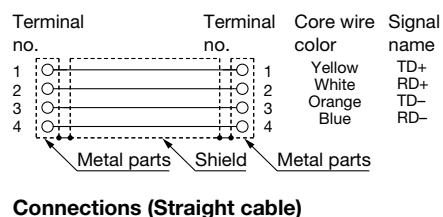
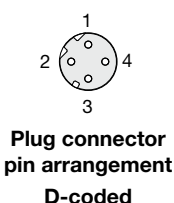

ZKJ Series

① Communication Cable

For PROFINET For EtherNet/IP™

EX9-AC 020 EN-PSRJ (Plug/RJ-45 connector)

● Cable length (L)

010	1000 mm
020	2000 mm
030	3000 mm
050	5000 mm
100	10000 mm

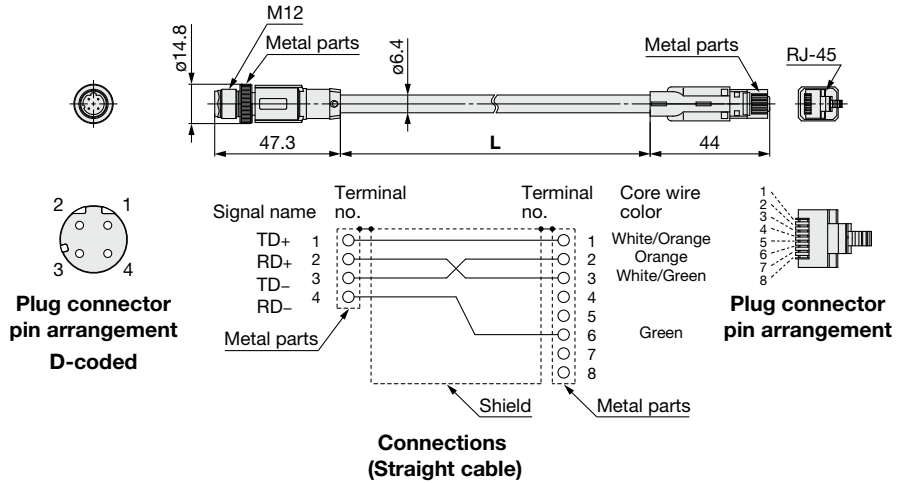

Item	Specifications
Cable O.D.	ø6.4 mm
Conductor nominal cross section	0.14 mm ² /AWG26
Wire O.D. (Including insulator)	0.98 mm
Min. bending radius (Fixed)	26 mm

PCA-1446566 (Plug)

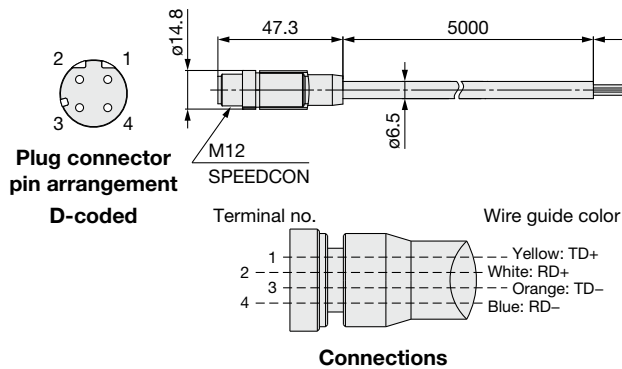

Item	Specifications
Cable O.D.	ø6.5 mm
Conductor nominal cross section	0.34 mm ² /AWG22
Wire O.D. (Including insulator)	1.55 mm
Min. bending radius (Fixed)	19.5 mm

① Communication Cable

For IO-Link

Connection examples

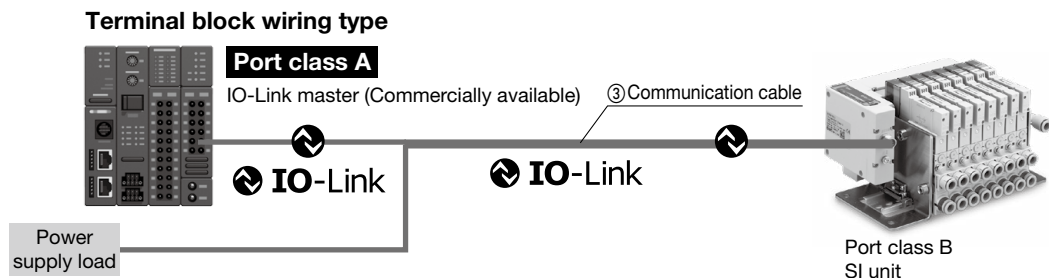
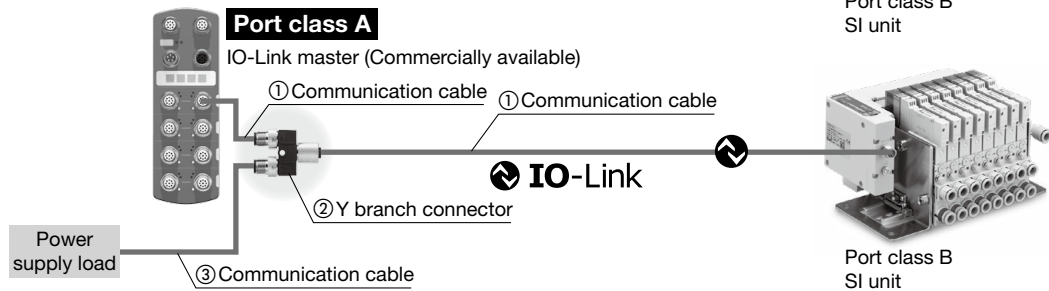
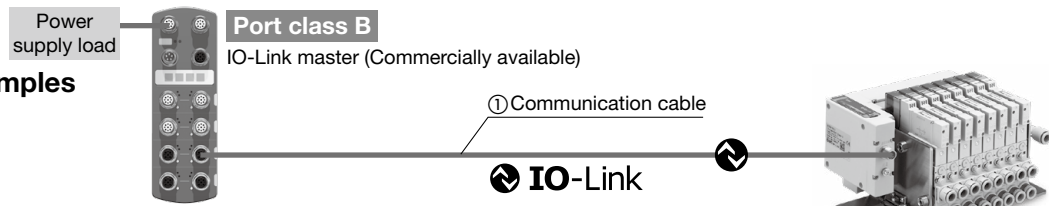

① Communication cable

EX9-AC 005 -SSPS (With connector on both sides (Socket/Plug))

● Cable length (L)

005	500 mm
010	1000 mm
020	2000 mm
030	3000 mm
050	5000 mm
100	10000 mm

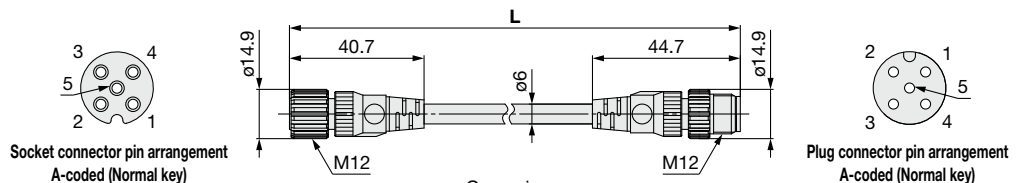

Item	Specifications
Cable O.D.	ø6 mm
Conductor nominal cross section	0.3 mm ² /AWG22
Wire O.D. (Including conductor)	1.5 mm
Min. bending radius (Fixed)	40 mm

EX9-AC 005 -SAPA (With connector on both sides (Socket/Plug))

● Cable length (L)

005	500 mm
010	1000 mm
020	2000 mm
030	3000 mm
050	5000 mm
100	10000 mm

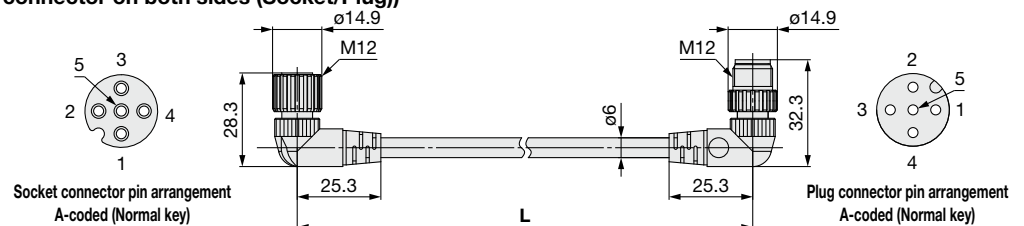

Item	Specifications
Cable O.D.	ø6 mm
Conductor nominal cross section	0.3 mm ² /AWG22
Wire O.D. (Including conductor)	1.5 mm
Min. bending radius (Fixed)	40 mm

ZKJ Series

① Communication Cable

For IO-Link

② Y branch connector

This connector is used to supply output power by branching the IO-Link communication cable when a port class A IO-Link master is used.

EX9-ACY02-S

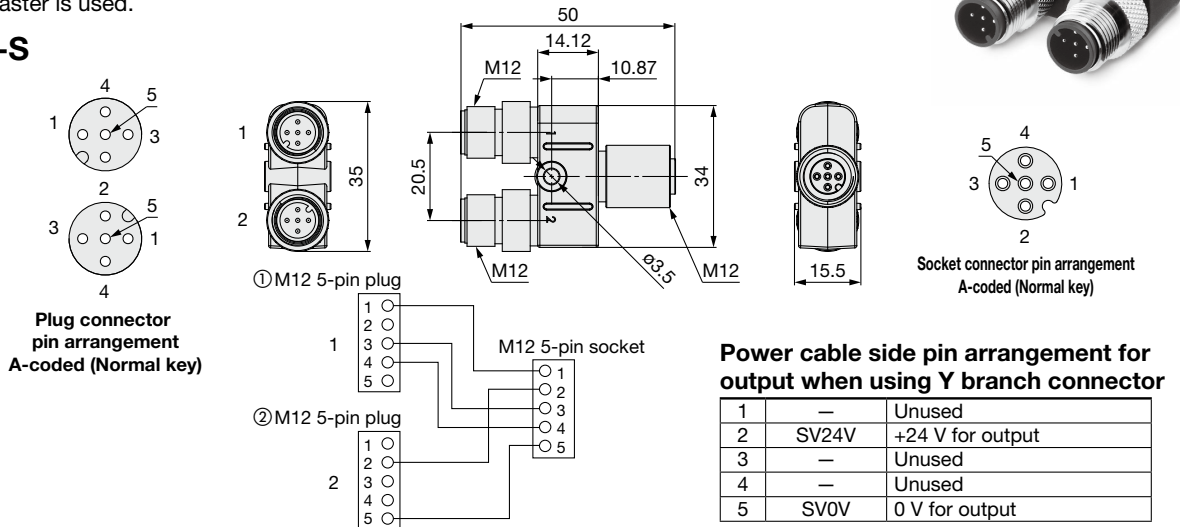

③ Communication cable

EX500-AP 050 - S

Cable length (L)

Code	Length (mm)
010	1000
050	5000

Connector specification

Code	Specification
S	Straight
A	Angled

Straight connector type

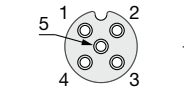

Socket connector pin arrangement A-coded (Normal key)

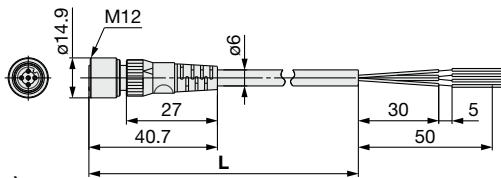

Item	Specifications
Cable O.D.	ø6 mm
Conductor nominal cross section	0.3 mm ² /AWG22
Wire O.D. (Including insulator)	1.5 mm
Min. bending radius (Fixed)	40 mm

Angled connector type

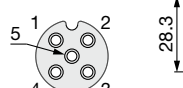

Socket connector pin arrangement A-coded (Normal key)

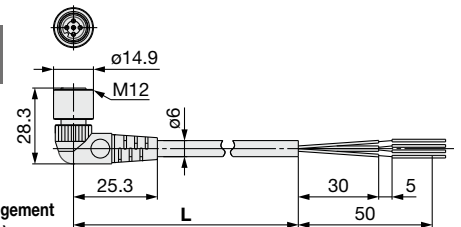

Item	Specifications
Cable O.D.	ø6 mm
Conductor nominal cross section	0.3 mm ² /AWG22
Wire O.D. (Including insulator)	1.5 mm
Min. bending radius (Fixed)	40 mm

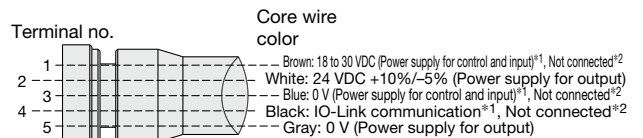

Connections (IO-Link)

- *1 When used as an IO-Link communication cable
- *2 When used as a solenoid valve power supply cable

1 Communication Cable



With connector on one side (Socket)

Cable length: 10000 mm

EX500-AP100-S-X1

• Connector specification

S	Straight
A	Angled

Straight connector type

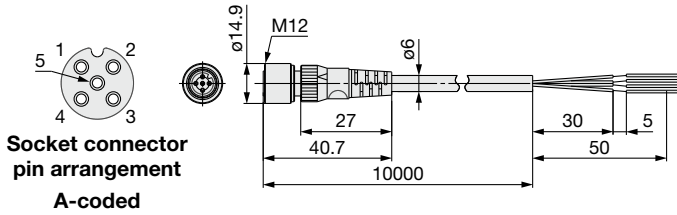

Item	Specifications
Cable O.D.	ø6 mm
Conductor nominal cross section	0.3 mm ² /AWG22
Wire O.D. (Including insulator)	1.5 mm
Min. bending radius (Fixed)	40 mm

Angled connector type

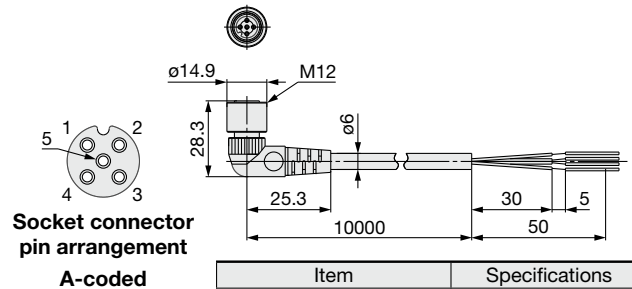

Item	Specifications
Cable O.D.	ø6 mm
Conductor nominal cross section	0.3 mm ² /AWG22
Wire O.D. (Including insulator)	1.5 mm
Min. bending radius (Fixed)	40 mm

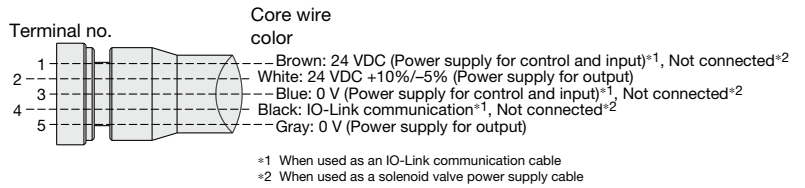

Connections (IO-Link)

PCA-1401804

• Cable length (L)

1401804	1500 mm
1401805	3000 mm
1401806	5000 mm

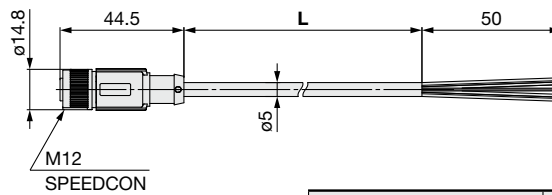
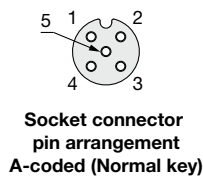

Item	Specifications
Cable O.D.	ø5 mm
Conductor nominal cross section	0.34 mm ² /AWG22
Wire O.D. (Including insulator)	1.27 mm
Min. bending radius (Fixed)	21.7 mm

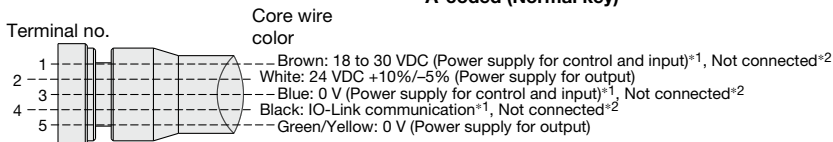

Connections (IO-Link)

*1 When used as an IO-Link communication cable *2 When used as an output power supply cable

ZKJ Series

② Field-wireable Communication Connector

For PROFINET For EtherNet/IP™

PCA-1446553

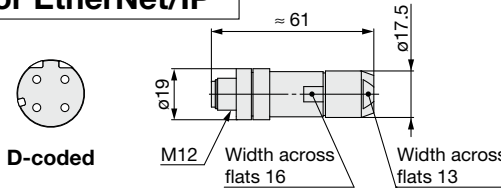

Applicable Cable

Item	Specifications
Cable O.D.	4.0 to 8.0 mm
Wire gauge (Stranded wire cross section)	0.14 to 0.34 mm ² /AWG26 to 22

* The table above shows the specifications for the applicable cable. Adaptation for the connector may vary on account of the conductor construction of the electric wire.

③ Power Supply Cable

For PROFINET For EtherNet/IP™

EX500-AP 050 - S

Cable length (L) Connector specification

010	1000 mm
050	5000 mm

S	Straight
A	Angled

Straight connector type

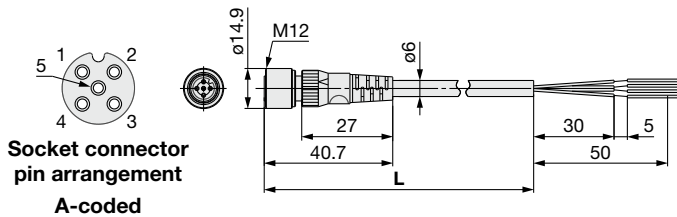

Angled connector type

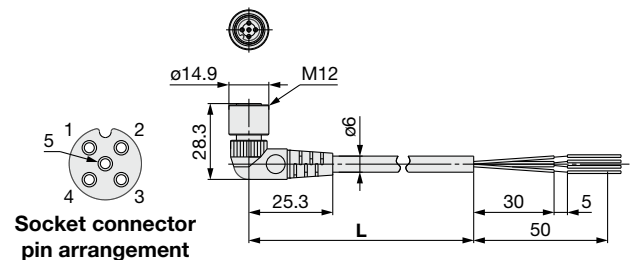

Item	Specifications
Cable O.D.	ø6 mm
Conductor nominal cross section	0.3 mm ² /AWG22
Wire O.D. (Including insulator)	1.5 mm
Min. bending radius (Fixed)	40 mm

Item	Specifications
Cable O.D.	ø6 mm
Conductor nominal cross section	0.3 mm ² /AWG22
Wire O.D. (Including insulator)	1.5 mm
Min. bending radius (Fixed)	40 mm

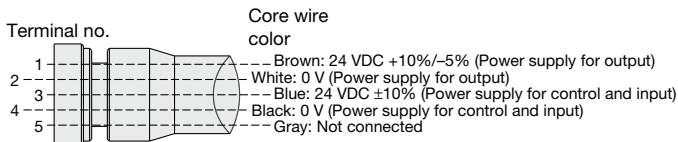

Connections (PROFINET)

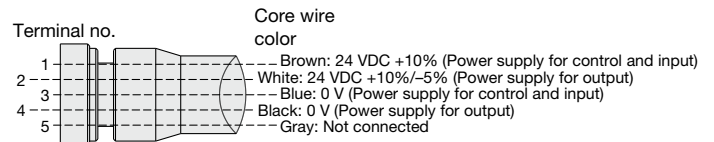

Connections (EtherNet/IP™)

PCA-1401804

Cable length (L)

1401804	1500 mm
1401805	3000 mm
1401806	5000 mm

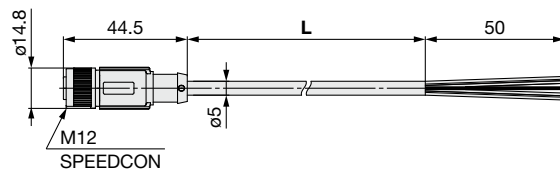
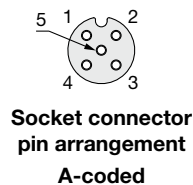

Item	Specifications
Cable O.D.	ø5 mm
Conductor nominal cross section	0.34 mm ² /AWG22
Wire O.D. (Including insulator)	1.27 mm
Min. bending radius (Fixed)	21.7 mm

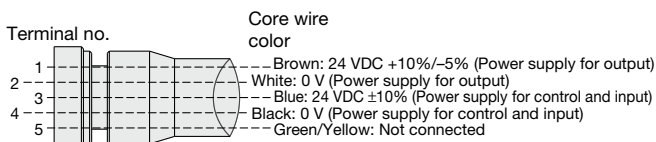

Connections (PROFINET)

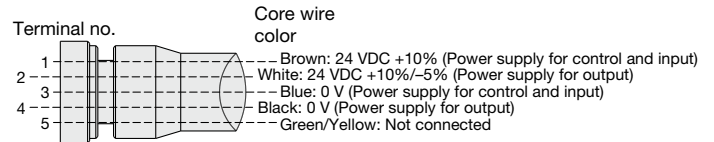

Connections (EtherNet/IP™)

3 Power Supply Cable



With connector on one side (Socket)

Cable length: 10000 mm

EX500-AP100-**S**-X1

● Connector specification

S	Straight
A	Angled

Straight connector type

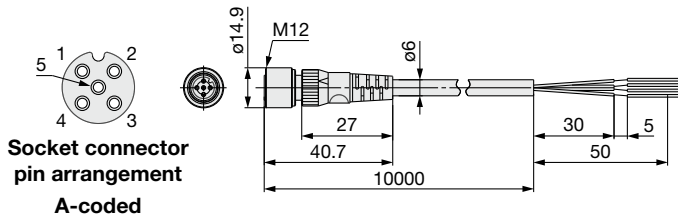

Item	Specifications
Cable O.D.	ø6 mm
Conductor nominal cross section	0.3 mm ² /AWG22
Wire O.D. (Including insulator)	1.5 mm
Min. bending radius (Fixed)	40 mm

Angled connector type

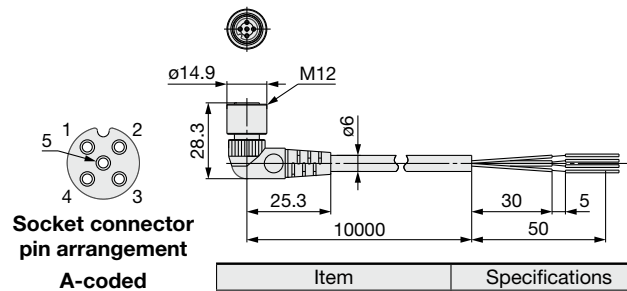

Item	Specifications
Cable O.D.	ø6 mm
Conductor nominal cross section	0.3 mm ² /AWG22
Wire O.D. (Including insulator)	1.5 mm
Min. bending radius (Fixed)	40 mm

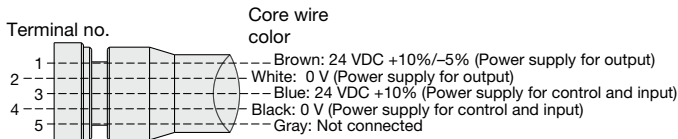

Connections (PROFINET)

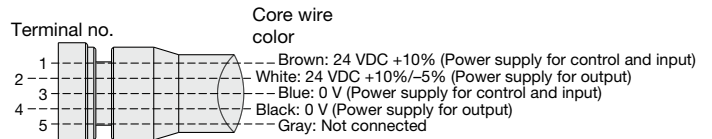

Connections (EtherNet/IP™)

4 Seal Cap (10 pcs.)

Use this on ports that are not being used for communication connector (M12, M8 connector socket).

Use of this seal cap maintains the integrity of the IP65 enclosure.

* Tighten the seal cap with the prescribed tightening torque. (For M12: 0.1 N·m, For M8: 0.05 N·m)

EX9-AW**TS**

● Connector specification

TS	For M12 connector socket (10 pcs.)
ES	For M8 connector socket (10 pcs.)

The EX260-VPN1 and EX260-VEN1 come with 1 seal cap, and the EX260-VEC1 comes with 2 seal caps.

EX9-AWES
For M8 connector socket

EX9-AWTS
For M12 connector socket

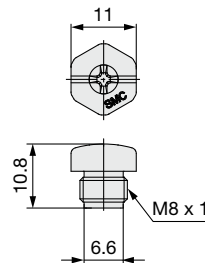

M8 connector (For socket)

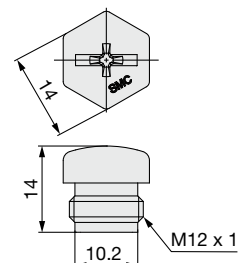

For M12 connector socket

■ Trademark

EtherNet/IP® is a registered trademark of ODVA, Inc.

EtherCAT® is registered trademark and patented technology, licensed by Beckhoff Automation GmbH, Germany.

Safety Instructions

These safety instructions are intended to prevent hazardous situations and/or equipment damage. These instructions indicate the level of potential hazard with the labels of “**Caution**,” “**Warning**” or “**Danger**.” They are all important notes for safety and must be followed in addition to International Standards (ISO/IEC)*1), and other safety regulations.

 **Danger :** **Danger** indicates a hazard with a high level of risk which, if not avoided, will result in death or serious injury.

 **Warning:** **Warning** indicates a hazard with a medium level of risk which, if not avoided, could result in death or serious injury.

 **Caution:** **Caution** indicates a hazard with a low level of risk which, if not avoided, could result in minor or moderate injury.

*1) ISO 4414: Pneumatic fluid power - General rules and safety requirements for systems and their components
ISO 4413: Hydraulic fluid power - General rules and safety requirements for systems and their components
IEC 60204-1: Safety of machinery - Electrical equipment of machines - Part 1: General requirements
ISO 10218-1: Robots and robotic devices - Safety requirements for industrial robots - Part 1: Robots etc.

Warning

1. The compatibility of the product is the responsibility of the person who designs the equipment or decides its specifications.

Since the product specified here is used under various operating conditions, its compatibility with specific equipment must be decided by the person who designs the equipment or decides its specifications based on necessary analysis and test results. The expected performance and safety assurance of the equipment will be the responsibility of the person who has determined its compatibility with the product. This person should also continuously review all specifications of the product referring to its latest catalog information, with a view to giving due consideration to any possibility of equipment failure when configuring the equipment.

2. Only personnel with appropriate training should operate machinery and equipment.

The product specified here may become unsafe if handled incorrectly. The assembly, operation and maintenance of machines or equipment including our products must be performed by an operator who is appropriately trained and experienced.

3. Do not service or attempt to remove product and machinery/equipment until safety is confirmed.

1. The inspection and maintenance of machinery/equipment should only be performed after measures to prevent falling or runaway of the driven objects have been confirmed.
2. When the product is to be removed, confirm that the safety measures as mentioned above are implemented and the power from any appropriate source is cut, and read and understand the specific product precautions of all relevant products carefully.
3. Before machinery/equipment is restarted, take measures to prevent unexpected operation and malfunction.

4. SMC products cannot be used beyond their specifications. They are not developed, designed, and manufactured to be used under the following conditions or environments. Use under such conditions or environments is not allowed.

1. Conditions and environments outside of the given specifications, or use outdoors or in a place exposed to direct sunlight.
2. Use for nuclear power, railways, aviation, space equipment, ships, vehicles, military application, equipment affecting human life, body, and property, combustion equipment, entertainment equipment, emergency shut-off circuits, press clutches, brake circuits, safety equipment, etc., and use for applications that do not conform to standard specifications such as catalogs and operation manuals.
3. Use for interlock circuits, except for use with double interlock such as installing a mechanical protection function in case of failure. Please periodically inspect the product to confirm that the product is operating properly.

Caution

SMC develops, designs, and manufactures products to be used for automatic control equipment, and provides them for peaceful use in manufacturing industries.

Use in non-manufacturing industries is not allowed.

Products SMC manufactures and sells cannot be used for the purpose of transactions or certification specified in the Measurement Act of each country. The new Measurement Act prohibits use of any unit other than SI units in Japan.

Limited warranty and Disclaimer/ Compliance Requirements

The product used is subject to the following “Limited warranty and Disclaimer” and “Compliance Requirements”.

Read and accept them before using the product.

Limited warranty and Disclaimer

1. The warranty period of the product is 1 year in service or 1.5 years after the product is delivered, whichever is first.*2)
Also, the product may have specified durability, running distance or replacement parts. Please consult your nearest sales branch.
2. For any failure or damage reported within the warranty period which is clearly our responsibility, a replacement product or necessary parts will be provided.
This limited warranty applies only to our product independently, and not to any other damage incurred due to the failure of the product.
3. Prior to using SMC products, please read and understand the warranty terms and disclaimers noted in the specified catalog for the particular products.

*2) **Suction cups (Vacuum pads) are excluded from this 1 year warranty.**

A suction cup (vacuum pad) is a consumable part, so it is warranted for a year after it is delivered.

Also, even within the warranty period, the wear of a product due to the use of the suction cup (vacuum pad) or failure due to the deterioration of rubber material are not allowed by the limited warranty.

Compliance Requirements

1. The use of SMC products with production equipment for the manufacture of weapons of mass destruction (WMD) or any other weapon is strictly prohibited.
2. The exports of SMC products or technology from one country to another are governed by the relevant security laws and regulations of the countries involved in the transaction. Prior to the shipment of a SMC product to another country, assure that all local rules governing that export are known and followed.

Revision History

Edition B * A positive pressure unit has been added.

* The number of pages has been increased from 32 to 36.

 **Safety Instructions** Be sure to read the “Handling Precautions for SMC Products” (M-E03-3) and “Operation Manual” before use.