

High Speed Pilot Operated Solenoid Valve



High Speed
ON 2.5 ms OFF 3 ms

Large flow rate

330^{*1} L/min (ANR)

Enclosure

IP67

Power saving

Select from 3^{*2} or 5 port.

1.5 W
 (With power-saving circuit)

Compact

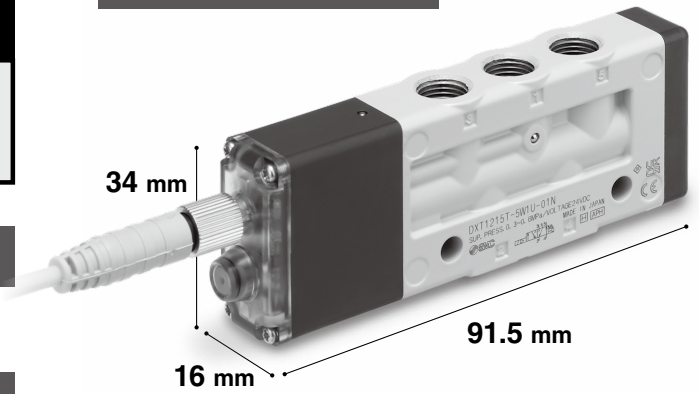

*1 When the inlet side is 0.6 MPa, and the differential pressure is 0.1 MPa
 *2 3-port type: Made to order (-X1)

Applications Can be used for the air blow and high-speed operation of actuators

For high-speed liquid agent coating processes

For blow-off sorting processes

For high-speed delivery processes

Good

Defective

Caution The applications described here are for reference purposes only. Therefore, the function is not guaranteed. For actual use, please conduct thorough evaluation and validation testing in order to determine the feasibility under your actual operating conditions.

DXT1215 Series



21-E778

DXT1215 Series

Valve Specifications

Valve type		Rubber seal	
Fluid		Air	
Ambient and fluid temperatures [°C]		-10 to 60 (No freezing)*1	
Internal pilot operating pressure range [MPa]	2-position single	0.3 to 0.6	
Response time [ms]*2		ON: 2.5 OFF: 3	
Max. operating frequency [Hz]	2-position single	200	
Manual override		Non-locking push type	
Pilot exhaust type	Internal pilot	Common exhaust	
Lubrication		Not required	
Mounting orientation*3		Unrestricted	
Impact/Vibration resistance*3 [m/s ²]		150/30	
Enclosure		IP67	
Electrical entry		M8 connector	
Coil rated voltage [V]		24 VDC	
Allowable voltage fluctuation [V]		-5% to +10% of the rated voltage	
Power consumption [W]	DC	With power-saving circuit	
Surge voltage suppressor		Diode	
Indicator light		LED	
Weight [g]		96	

- *1 The upper limits of the ambient and fluid temperatures vary depending on the operating frequency. (Refer to the graph below.) If a follow-up operation is performed at a duty ratio of 50% or higher, the upper limit value may change. Please contact SMC for further details.
- *2 Based on the JIS B 8419:2010 dynamic performance test (Coil temperature: 20°C, pressure: 0.5 MPa, at the rated voltage)
- *3 Impact resistance: No malfunction occurred when it was tested in the axial direction and at a right angle to both the main valve and the armature in both an energized and de-energized state, once for each condition. (Values at the initial period)
Vibration resistance: No malfunction occurred in a one-sweep test between 45 and 2000 Hz. The test was performed in both an energized and de-energized state in the axial direction and at a right angle to both the main valve and the armature. (Values at the initial period)
- *4 Only applicable to the power-saving circuit specification.

Flow Rate Characteristics

Model	Port size		Valve flow rate characteristics			
	1, 5, 3 (P, EA, EB)	4, 2 (A, B)	1 → 4/2 (P → A/B)		4/2 → 5/3 (A/B → E)	
			C [dm ³ /(s·bar)]	b	C [dm ³ /(s·bar)]	b
DXT1215	1/8	1/8	1.3	0.37	1.3	0.23

* Calculation of effective area "S" and sonic conductance "C": S = 5.0 x C

Operating Frequency

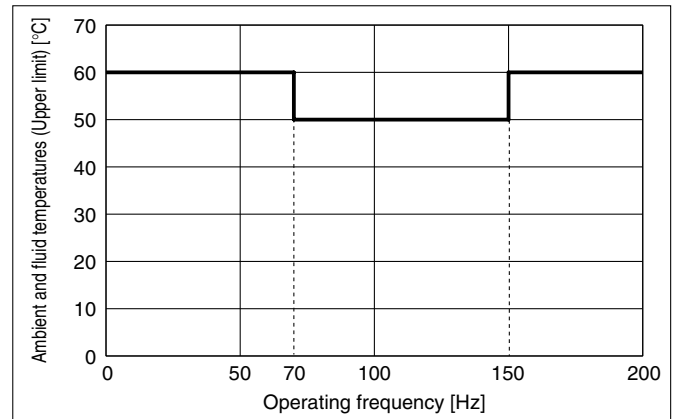

Valve Construction

2-position single

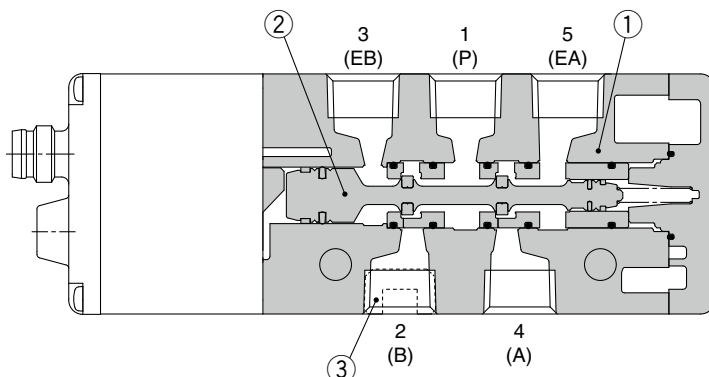

2-position single
Standard 5-port
specification

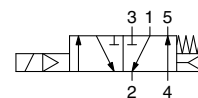

Made to Order
3-port specification
(-X1)

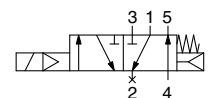

Component Parts

No.	Description	Material
1	Body	Aluminum die-casted
2	Spool assembly	Aluminum/FKM
3	Plug (For the -X1)	Steel

How to Order Valves

DXT1215 T - 5 W □ U - 01 N - X1



1 Coil type

T	With power-saving circuit
----------	---------------------------

2 Rated voltage

5	24 VDC
----------	--------

3 Electrical entry

M8 connector*1	
W □	WO
With straight connector cable	Without connector cable

4 Light/surge voltage suppressor

U	With light/surge voltage suppressor (Non-polar)
----------	---

5 4(A)/2(B) port size

01	1/8
-----------	-----

6 Thread type

Nil	Rc
F	G
N	NPT

7 Made to Order

Nil	—
X1	3-port specification [2(B) port plug]

*1 For the connector cable for M8 connectors, refer to the back cover. For W □, enter the cable length symbol in the □. Please be sure to fill in the blank, referring to the back cover.

* The 3-port specification is a specification with the 2(B) port plugged and closed. The 3(EB) port should be kept open for pilot exhaust.

Dimensions

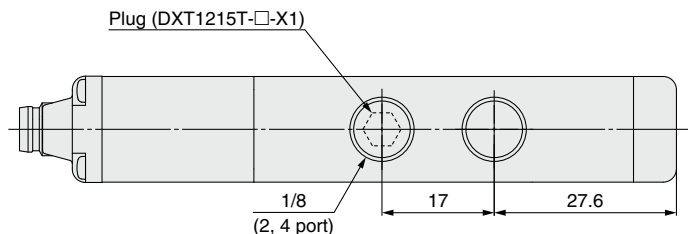
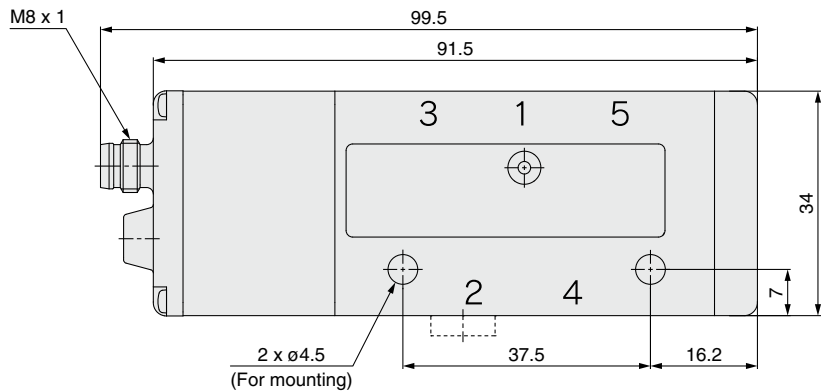
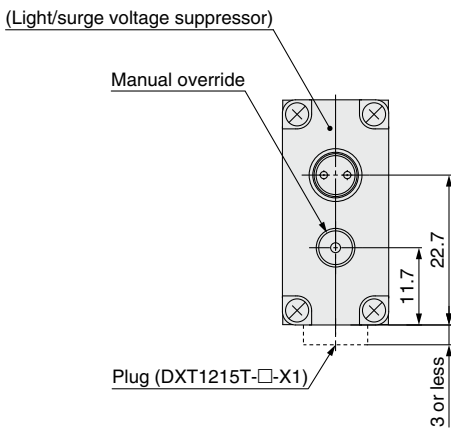
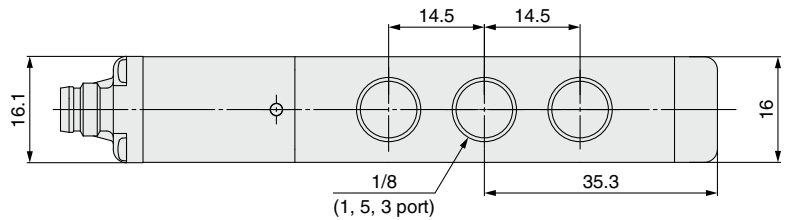



DXT1215 Series Specific Product Precautions

Be sure to read this before handling the products. For safety instructions and 3/4/5-port solenoid valve precautions, refer to the "Handling Precautions for SMC Products" and the "Operation Manual" on the SMC website: <https://www.smcworld.com>

Environment

Warning

Do not use the valves in atmospheres in which corrosive gases, chemicals, sea water, water, or water vapor are present or where there is direct contact with any of these.

Manual Override

Warning

Manual override is used to switch the main valve without inputting an electrical signal for the valve. As the connected actuator will start operating due to this manual operation, be sure to confirm that it is safe to do so beforehand.

Non-locking push type

Push the manual override button all the way down.

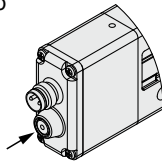

Installation

Caution

Even if the inlet pressure is within the operating pressure range, when the piping diameter is restricted due to size reduction of the supply port (P), the flow will be insufficient. In such cases, the valve will not switch completely and the cylinder may malfunction.

Surge Voltage Suppressor

With power-saving circuit (PWM circuit built-in type, non-polar type)

The power consumption has been reduced to approx. 1/4 of the startup power by eliminating the need for electrical current for holding. (Effective after being energized for more than 5 ms when the 24 VDC rated voltage is applied)

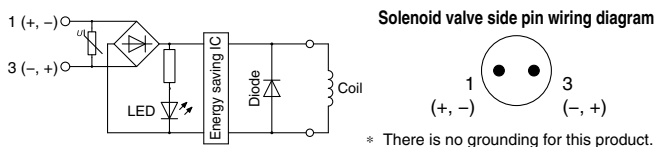

Operating principle

The circuit shown above reduces power consumption by eliminating the need for electrical current for holding in order to save energy. Refer to the electrical power waveform shown in the graph on the right.

<Power-saving electric waveform>

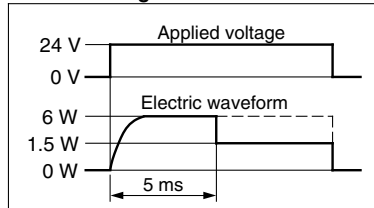

Residual voltage of the surge voltage suppressor

If a diode surge voltage suppressor is used, there will be a residual voltage of approx. 1 V. Pay attention to the surge voltage protection on the controller side.

M8 Connector Type

Connector cable

The connector cable for M8 connectors can be ordered as follows.

How to Order

1. To order a solenoid valve and the connector cable at the same time (The connector cable will be included in the shipment of the solenoid valve.)

DXT1215T-5W **U-01** **(-X1)**

• Cable length [mm]

Ex. 1) Cable length: 300 mm

DXT1215T-5W1U-01 **(-X1)**

• Symbol for electrical entry

Symbol	Cable length [mm]
1	300
2	500
3	1000
4	2000
5	3000
6	4000
7	5000

2. To order only the connector cable

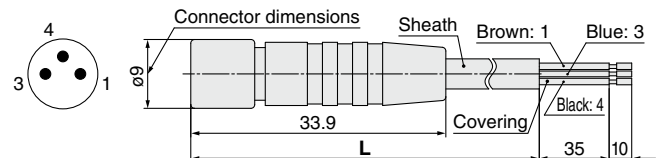

Cable length (L)	Part no.
300 mm	V100-49-1-1
500 mm	V100-49-1-2
1000 mm	V100-49-1-3
2000 mm	V100-49-1-4
3000 mm	V100-49-1-5
4000 mm	V100-49-1-6
5000 mm	V100-49-1-7

Sheath O.D.	ø3.4 mm
Cover diameter	ø1.16 mm
Conductor area	0.16 mm ²

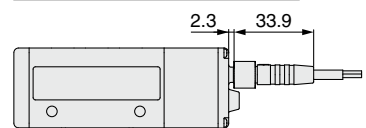

Recommended M8 Connector Angle Type



Cable length	PHOENIX CONTACT	
	Product no.	Order no.
1.5 m	SAC-3P-1,5-PUR/M 8FR	1669738
3 m	SAC-3P-3,0-PUR/M 8FR	1669741
5 m	SAC-3P-5,0-PUR/M 8FR	1669631
10 m	SAC-3P-10,0-PUR/M 8FR	1694169

Caution Phoenix Contact products should be ordered directly from the manufacturer or from its distributors.

Caution

- The M8 connector type is IP67 compliant (according to IEC 60529) and protected against dust and water. However, it cannot be used under water. Select an SMC connector cable (V100-49-1-) or an FA sensor type connector with M8 threaded 3-pin specifications conforming to Nippon Electric Control Equipment Association Standard NECA4202 (IEC 60947-5-2).
- Do not use a tool to mount the connector as this may damage it. Only tighten the connector by hand. (0.4 to 0.6 N·m)
- The application of excessive force on the cable connector will result in it no longer being able to satisfy the IP67 requirements. Please use caution and refrain from applying any force of 30 N or greater on the connector.

Failure to satisfy the IP67 requirements may result if using connectors other than those shown above or if the connector is insufficiently tightened.

Safety Instructions Be sure to read the "Handling Precautions for SMC Products" (M-E03-3) and "Operation Manual" before use.

SMC Corporation

Akihabara UDX 15F,
4-14-1, Sotokanda, Chiyoda-ku, Tokyo 101-0021, JAPAN
Phone: 03-5207-8249 Fax: 03-5298-5362
<https://www.smcworld.com>
© 2022 SMC Corporation All Rights Reserved