

Circulating Fluid Temperature Controller

EU F-Gas Regulation-compliant Refrigerated Thermo-chiller

HRZ-F Series



SEMI Standard
S2, S8, F47

RoHS

More effective energy-saving is achieved through use of a DC inverter compressor and an inverter pump.

Type of circulating fluid	Fluorinated fluids, Ethylene glycol aqueous solution, Water
Temperature range setting	-20 to 40°C/10 to 60°C/-20 to 90°C
Cooling capacity	2 kW/4 kW/8 kW/10 kW to Max.15 kW
Temperature stability	±0.1°C
Refrigerant	R410A (HFC)/R448A (HFC/HFO)



Energy Saving

The inverter controls the number of motor rotations of the compressor and pump according to the load from the user's application.

Power consumption **Max. 65% reduction**

Operating conditions: 20°C, 0 kW with 50% load, 8 kW with 50% load

Existing model **HRZ004-L** 5.7 kW

F-Gas **HRZ008-WS-F** 2 kW **65% reduction**

Operating conditions: -10°C, 0 kW with 50% load, 4 kW with 50% load

Existing model **HRZ004-L** 5.2 kW

F-Gas **HRZ008-WS-F** 2.1 kW **60% reduction**

- Reduced running cost
- Contribution to the environmental preservation (CO₂ Emission-reducing)

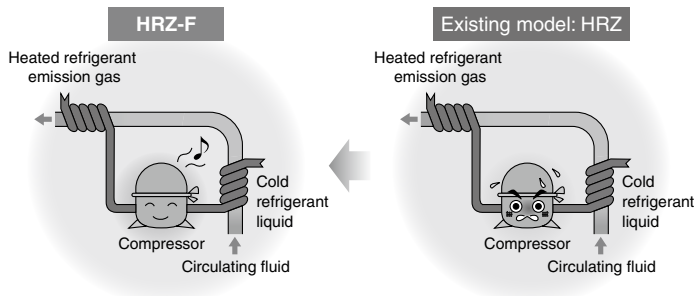

* This illustration is for an image only. For piping systems, refer to "Construction and Principles" on page 435.

Facility water **Max. 67% reduction**

Operating conditions: 20°C, 0 kW with 50% load, 8 kW with 50% load

Existing model **HRZ004-L** 15.8 LPM

F-Gas **HRZ008-WS-F** 6.5 LPM **59% reduction**

Operating conditions: -10°C, 0 kW with 50% load, 4 kW with 50% load

Existing model **HRZ004-L** 12.1 LPM

F-Gas **HRZ008-WS-F** 4 LPM **67% reduction**

- Reduced facilities investment
- Space saved facility water equipment
- Reduced running cost

High Performance

Temperature stability **±0.1°C**

(When a load is stable)

Improved temperature control technology achieves temperature stability of ±0.1°C when the load is stable.

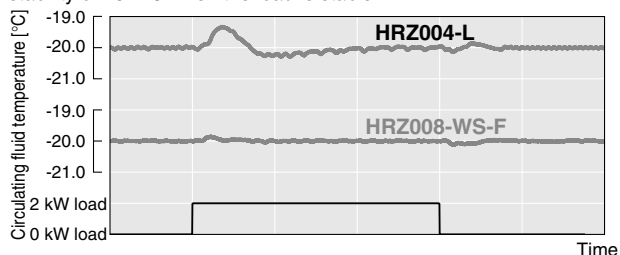

Cooling time **Max. 46% reduction**

(SMC comparison)

Special temperature control technology achieved the utmost performance, resulting in the reduced cooling time.

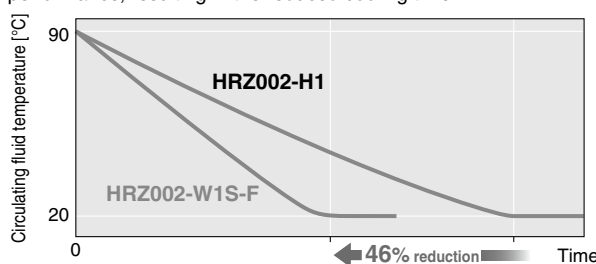

Leakless

All-in-one tank

Housing the pump or heat exchanger inside the tank has eliminated any external leakage of the circulating fluid.

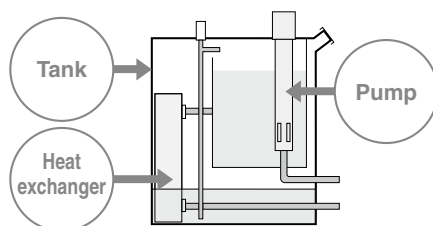

Communications

- Contact input/output signal
- Serial RS-485 communication
- Analog communication (Refer to "Options" on page 452.)
- DeviceNet communication (Refer to "Options" on page 452.)

DeviceNet

■ Trademark

DeviceNet® is a registered trademark of ODVA, Inc.

■ **Fluid contact parts adopt the materials compatible for various circulating fluids.** (Stainless steel, EPDM, etc.)

- Fluorinated fluids: Flourinert™ FC-3283, FC-40, GALDEN® HT135, HT200
- 60% ethylene glycol aqueous solution
- Deionized water/Tap water

Regarding the fluid other than the above, please contact SMC. Flourinert™ is a trademark of 3M. GALDEN® is a registered trademark, belonging to the Solvay Group or its corresponding owner.

Easy Maintenance

■ Circulating fluid automatic recovery function

(Option [p. 453](#))

Circulating fluid inside a thermo-chiller tank can be recovered automatically.
(Recovery volume: 16 L to 17 L)

- Reduced maintenance time
- Faster operation
- Reduced circulating liquid loss by evaporation or spill

All you have to do is to push the communication button for recovery and reset!

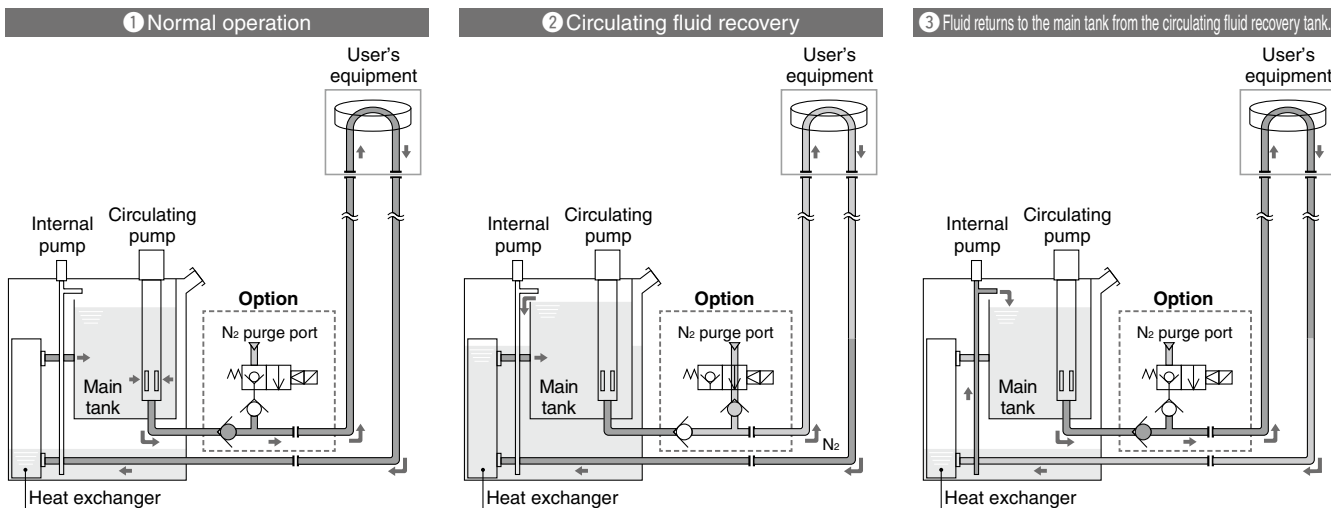
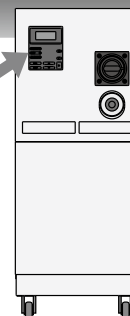

■ Circulating fluid electric resistance ratio control function (Option [p. 452](#))

(DI control kit)

■ Easy maintenance

- Checking the electrical component parts accessible from the front side only

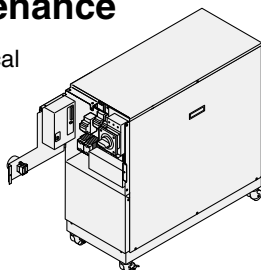

- Possible to replace the maintenance parts (such as a pump) without removing the pipings and discharging the circulating fluid.
- Various alarm displays [p. 451](#)

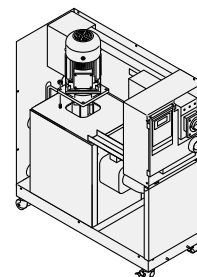

Information about EU F-Gas Regulation (517/2014)



Variations

Model	Cooling capacity	Type	Circulating fluid	Options p. 452	Standards
HRZ008-L□-F	8 kW	Pump inverter	<ul style="list-style-type: none"> • Fluorinated fluids • Ethylene glycol aqueous solution 	<ul style="list-style-type: none"> • Analog communication • DeviceNet communication • NPT fitting • SI unit only • DI control kit • Circulating fluid automatic recovery 	
HRZ002-W□S-F	2 kW	Pump inverter and Compressor inverter	<ul style="list-style-type: none"> • Fluorinated fluids • Ethylene glycol aqueous solution • Tap water/Deionized water 		
HRZ004-W□S-F	4 kW				
HRZ008-W□S-F	8 kW				
HRZ010-W□S-F	10 kW				

Construction and Principles

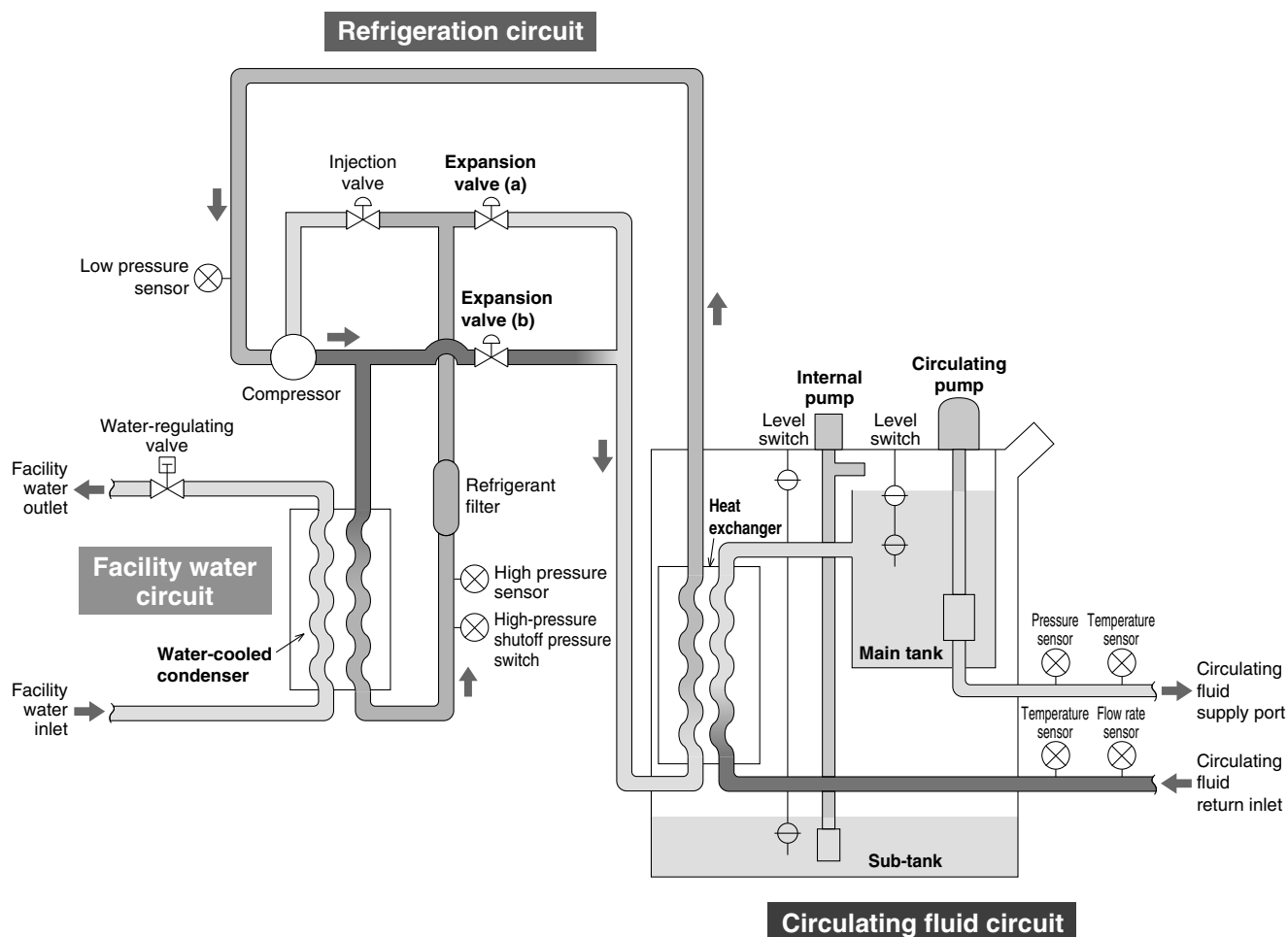

Refrigeration circuit

When the circulating fluid temperature is rising higher than the set temperature, open the **expansion valve (a)** to introduce refrigerant gas at a lower temperature to the **heat exchanger**. With this, the circulating fluid will be cooled down.

Oppositely, when the circulating fluid is getting lower against the set temperature, open the **expansion valve (b)** and introduce refrigerant gas at a high temperature without going through the **water-cooled condenser** to the **heat exchanger**. With this heat, the circulating fluid will be heated.

Circulating fluid circuit

With the **circulating pump**, circulating fluid will be discharged to the user's equipment side. After the circulating fluid will heat or cool the user's equipment side, it will be returned to the **main tank** via the **heat exchanger**.

A **sub-tank** is not used under the normal operation. It will be used when a circulating fluid is recovered from the user's equipment side.

The **internal pump** is used to transfer a circulating fluid from the **sub-tank** to the **main tank**.

(Circulating fluid automatic recovery function [p. 453](#))

CONTENTS

HRZ-F Series



Circulating Fluid Temperature Controller

EU F-Gas Regulation-compliant Refrigerated Thermo-chiller HRZ-F Series

● Model Selection

Guide to Model Selection	p. 437
Required Cooling Capacity Calculation	p. 438
Precautions on Model Selection	p. 439
Circulating Fluid Typical Physical Property Values	p. 440

● Thermo-chiller

Pump Inverter and Compressor Inverter Type

How to Order	p. 441
Specifications	p. 441
Cooling Capacity	p. 443
Heating Capacity	p. 443
Pump Capacity (Thermo-chiller Outlet)	p. 444

● Thermo-chiller Pump Inverter Type

How to Order	p. 445
Specifications	p. 445
Cooling Capacity	p. 446
Heating Capacity	p. 446
Pump Capacity (Thermo-chiller Outlet)	p. 446

● Common Specifications

Dimensions	p. 447
Communication Functions	p. 449
Operation Display Panel	p. 451
Alarm	p. 451

● Options

Analog Communication	p. 452
DeviceNet Communication	p. 452
NPT Fitting	p. 452
SI Unit Only	p. 452
DI Control Kit	p. 452
Circulating Fluid Automatic Recovery	p. 453

● Optional Accessories

① Bypass Piping Set	p. 454
② Anti-quake Bracket	p. 454
③ 4-Port Manifold	p. 455
④ DI Filter	p. 455
⑤ Insulating Material for DI Filter	p. 455
⑥ 60% Ethylene Glycol Aqueous Solution	p. 456
⑦ Concentration Meter	p. 456

Specific Product Precautions	p. 457
------------------------------	--------

HRZ-F Series Model Selection

Guide to Model Selection

1. How much is the temperature in degrees centigrade for the circulating fluid?

Temperature range which can be set with the thermo-chiller

L : -20°C to 40°C

W: -20°C to 90°C (10 to 60°C for HRZ□□□-W2S-F, -10 to 90°C for HRZ002-WS/W1S-F)

Example) User requirement: 50°C (→ W type is appropriate.)

2. What kind of the circulating fluids will be used?

Relationship between circulating fluid (which can be used with the thermo-chiller) and temperature

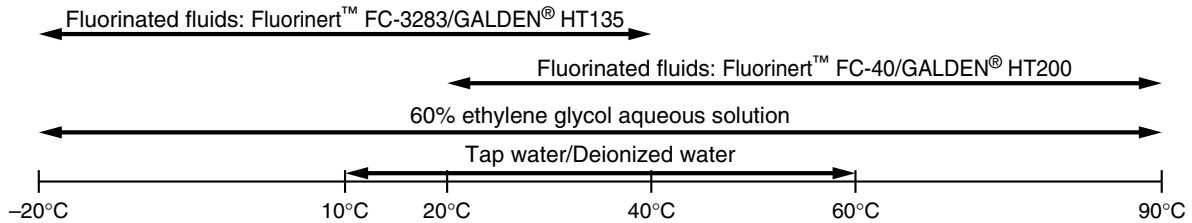

Example) User requirement: Fluorinated fluids

Based on the results in 1 and 2 above,
refer to the cooling capacity charts (pages 443 and 446) in "Fluorinated fluid."

3. What is the kW for the required cooling capacity?

* To calculate the cooling capacity, referring to page 438.

Example) User requirement: 5 kW →

Plot the point of intersection between the operating temperature (50°C) and the cooling capacity (5 kW) in the cooling capacity graph.

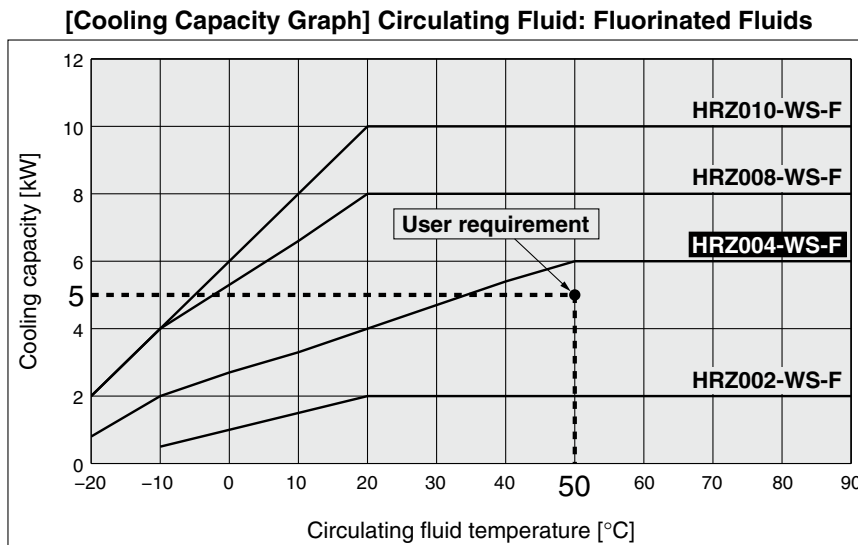

The point plotted in the graph is the requirement from the user. Select the thermo-chiller models exceeding this point. In this case, select the **HRZ004-WS-F**.

GALDEN® is a registered trademark, belonging to the Solvay Group or its corresponding owner. Fluorinert™ is a trademark of 3M.

Required Cooling Capacity Calculation

Example 1: When the heat generation amount in the user's equipment is known.

Heat generation amount **Q**: 3.5 kW

Cooling capacity = Considering a safety factor of 20%, $3.5 \times 1.2 = \boxed{4.2 \text{ kW}}$

Example 2: When the heat generation amount in the user's equipment is not known.

Obtain the temperature difference between inlet and outlet by circulating the circulating fluid inside the user's equipment.

Heat generation amount Q	: Unknown
Circulating fluid temperature difference $\Delta T (= T2 - T1)$: 6.0°C (6.0 K)
Circulating fluid outlet temperature T1	: 20°C (293.15 K)
Circulating fluid return temperature T2	: 26°C (299.15 K)
Circulating fluid flow rate L	: 20 L/min
Circulating fluid	: Fluorinated fluid
	Density γ : $1.80 \times 10^3 \text{ kg/m}^3$
	Specific heat C : 0.96 x 10 ³ J/(kg·K) (at 20°C)

* Refer to page 440 for the typical physical property values by circulating fluid.

$$Q = \frac{\Delta T \times L \times \gamma \times C}{60 \times 1000}$$

$$= \frac{6.0 \times 20 \times 1.80 \times 10^3 \times 0.96 \times 10^3}{60 \times 1000}$$

$$= 3456 \text{ W} = 3.5 \text{ kW}$$

Cooling capacity = Considering a safety factor of 20%,
 $3.5 \times 1.2 = \boxed{4.2 \text{ kW}}$

Example of conventional units (Reference)

Unknown

6.0°C

20°C

26°C

1.2 m³/h

Fluorinated fluid

Density γ : $1.80 \times 10^3 \text{ kg/m}^3$

Specific heat **C**: 0.23 kcal/kg·°C
(at 20°C)

* Refer to page 440 for the typical physical property values by circulating fluid.

$$Q = \frac{\Delta T \times L \times \gamma \times C}{860}$$

$$= \frac{6.0 \times 1.2 \times 1.80 \times 10^3 \times 0.23}{860}$$

$$= 3.5 \text{ kW}$$

Cooling capacity = Considering a safety factor of 20%,
 $3.5 \times 1.2 = \boxed{4.2 \text{ kW}}$

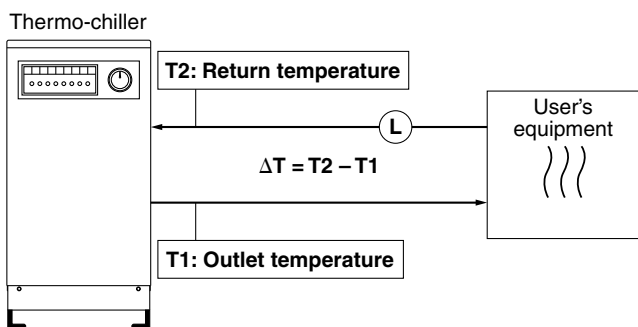

HRZ-F Series

Required Cooling Capacity Calculation

Example 3. When there is no heat generation, and when cooling the object below a certain temperature and period of time.

Cooled substance total volume V : 60 L
 Cooling time h : 15 min
 Cooling temperature difference ΔT : $\left\{ \begin{array}{l} 20^\circ\text{C} \text{ (20 K)} \\ (40^\circ\text{C} - 20^\circ\text{C} \rightarrow 20^\circ\text{C}) \end{array} \right.$
 Circulating fluid : Fluorinated fluid
 Density γ : $1.80 \times 10^3 \text{ kg/m}^3$
 Specific heat C : $0.96 \times 10^3 \text{ J/(kg}\cdot\text{K)}$
 (at 20°C)

* Refer to page 440 for the typical physical property values by circulating fluid.

$$Q = \frac{\Delta T \times V \times \gamma \times C}{h \times 60 \times 1000}$$

$$= \frac{20 \times 60 \times 1.80 \times 10^3 \times 0.96 \times 10^3}{15 \times 60 \times 1000}$$

$$= 2304 \text{ W} = 2.3 \text{ kW}$$

Cooling capacity = Considering a safety factor of 20%,

$$2.3 \times 1.2 = \mathbf{2.8 \text{ kW (When the circulating fluid temperature is } 20^\circ\text{C.)}}$$

(In this case, selected thermo-chiller model will be HRZ004-WS-F.)

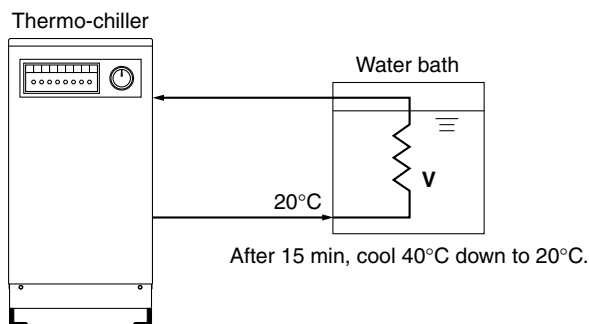

* This is the calculated value by changing the fluid temperature only. Thus, it varies substantially depending on the water bath or piping material or shape.

Precautions on Model Selection

1. Heating capacity

When setting the circulating fluid temperature at a higher temperature than the room temperature, the circulating fluid temperature will be heated with the thermo-chiller. Heating capacity varies depending on the model of the HRZ-F series. Also, the heating capacity varies depending on the circulating fluid temperature. Consider the heat radiation amount or thermal capacity of the user's equipment. Check beforehand if the required heating capacity is provided, based on the heating capacity graph for the respective model.

2. Pump capacity

<Circulating fluid flow rate>

Pump capacity varies depending on the model selected from the HRZ-F series. Also, circulating fluid flow varies depending on the circulating fluid discharge pressure. Consider the installation height difference between our thermo-chiller and a user's equipment, and the piping resistance such as circulating fluid pipings, or piping size, or piping curves in the machine. Check beforehand if the required flow is achieved using the pump capacity curves for each respective model.

<Circulating fluid discharge pressure>

Circulating fluid discharge pressure has the possibility to increase up to the maximum pressure in the pump capacity curves for the respective model. Check beforehand if the circulating fluid pipings or circulating fluid circuit of the user's equipment are fully durable against this pressure.

Example of conventional units (Reference)

0.06 m³
 0.25 h
 20°C
 Fluorinated fluid
 Density γ : $1.80 \times 10^3 \text{ kg/m}^3$
 Specific heat C : $0.23 \text{ kcal/kg}\cdot^\circ\text{C}$
 (at 20°C)

* Refer to page 440 for the typical physical property values by circulating fluid.

$$Q = \frac{\Delta T \times V \times \gamma \times C}{h \times 860}$$

$$= \frac{20 \times 0.06 \times 1.80 \times 10^3 \times 0.23}{0.25 \times 860}$$

$$= 2.3 \text{ kW}$$

Cooling capacity = Considering a safety factor of 20%,

$$2.3 \times 1.2 = \mathbf{2.8 \text{ kW (When the circulating fluid temperature is } 20^\circ\text{C.)}}$$

(In this case, selected thermo-chiller model will be HRZ004-WS-F.)

Circulating Fluid Typical Physical Property Values

* Shown below are reference values.
Please contact circulating fluid supplier for details.

Fluorinated Fluids

Physical property value Temperature	Density γ	Specific heat C	
	[kg/m ³] [g/L]	[J/(kg·K)]	[(kcal/kg·°C)]
-10°C	1.87 x 10 ³	0.87 x 10 ³	(0.21)
20°C	1.80 x 10 ³	0.96 x 10 ³	(0.23)
50°C	1.74 x 10 ³	1.05 x 10 ³	(0.25)
80°C	1.67 x 10 ³	1.14 x 10 ³	(0.27)

60% Ethylene Glycol Aqueous Solution

Physical property value Temperature	Density γ	Specific heat C	
	[kg/m ³] [g/L]	[J/(kg·K)]	[(kcal/kg·°C)]
-10°C	1.10 x 10 ³	3.02 x 10 ³	(0.72)
20°C	1.08 x 10 ³	3.15 x 10 ³	(0.75)
50°C	1.06 x 10 ³	3.27 x 10 ³	(0.78)
80°C	1.04 x 10 ³	3.40 x 10 ³	(0.81)

Water

Density γ : 1 x 10³ [kg/m³] [g/L]

Specific heat C: 4.2 x 10³ [J/(kg·K)] (1.0 [kcal/kg·°C])

EU F-Gas Regulation-compliant



Thermo-chiller Pump Inverter and Compressor Inverter Type

SEMI

HRZ-F Series

RoHS

How to Order

Pump Inverter and Compressor Inverter Type

HRZ 010 - W [] S - [] F []

Cooling capacity

Symbol	Cooling capacity
002	2 kW
004	4 kW
008	8 kW
010	10 kW

Circulating fluid type

Symbol	Circulating fluid type	Temperature range setting	2 kW	4 kW	8 kW	10 kW
Nil	Fluorinated fluids	-10 to 90°C	●			
		-20 to 90°C		●	●	●
1	Ethylene glycol aqueous solution	-10 to 90°C	●			
		-20 to 90°C		●	●	●
2	Water	10 to 60°C	●	●	●	●

EU F-Gas Regulation-compliant

Option 1 (Refer to page 452.)

Symbol	Contents
Nil	None
C	Analog communication
D	DeviceNet communication

When multiple options are combined, indicate symbols in alphabetical order.

Option 2

(Refer to pages 452 and 453.)

Symbol	Contents
Nil	None
N	NPT fitting
W	SI unit only
Y*1	DI control kit
Z	Circulating fluid automatic recovery

When multiple options are combined, indicate symbols in alphabetical order.
*1 Not equipped to the fluorinated fluid type.

Pump inverter and compressor inverter type

Specifications

Model	HRZ002-WS-F	HRZ004-WS-F	HRZ008-WS-F	HRZ010-WS-F
Channel/Cooling method	1 channel/Water-cooled refrigeration			
Temperature control method	PID control			
Refrigerant	R410A (HFC)			
Refrigerant charge	kg 1.5			
Ambient temperature	°C 10 to 35			
Ambient humidity*1	%RH 30 to 70			
Altitude	m 1000 or less			
Circulating fluid*2	Fully fluorinated fluid -20 to 40°C: Fluorinert™ FC-3283 GALDEN® HT135 20 to 90°C: Fluorinert™ FC-40 GALDEN® HT200			
Temperature range setting*1/Temperature stability*3	°C -10 to 90/±0.1		°C -20 to 90/±0.1	
Cooling capacity*4 (Under conditions below)	kW 2 (0.5)		kW 4 (2) 8 (4) 10 (4)	
Circulating fluid temperature	°C 20 (-10)			
Facility water temperature	°C 25			
Circulating fluid flow rate	L/min 20			
Pump capacity*5	MPa 0.65 (at 20 L/min) With flow control function by pump inverter		MPa 0.72 (at 20 L/min) With flow control function by pump inverter	
Rated flow*6	L/min 20			
Flow display range	L/min 10 to 40			
Flow range*7	L/min 10 to 40			
Discharge pressure display range	MPa 0 to 1.5			
Tank	Main tank capacity*8 L Approx. 15 Sub-tank capacity*9 L Approx. 16			
Contact material for circulating fluid	Stainless steel, EPDM, Copper brazing (Heat exchanger), Silicone, PPS, Fluororesin			
Height difference between this product and customer's equipment	m 10 or less			
Outlet port size	Rc3/4 (With plug)			
Return port size	Rc3/4 (With plug)			
Drain port size	Rc3/8 (With valve/plug)			
Temperature	°C 10 to 30			
Inlet pressure	MPa 0.3 to 0.7			
Inlet-outlet pressure differential of facility water	MPa 0.3 or more			
Required flow rate*10	L/min 10		L/min 12 15	
Inlet port size	Rc1/2 (With plug)			
Outlet port size	Rc1/2 (With plug)			
Contact material for cooling water	Stainless steel, EPDM, Copper brazing (Heat exchanger), Silicone, Brass, NBR			
Voltage	V 3-phase 200 VAC/200 to 208 ±10 [%] (50/60 Hz)			
Max. operating current	A 16		A 22 23 26	
Breaker capacity	A 20 (Earth leakage breaker sensitivity current: 30 mA)		A 30 (Earth leakage breaker sensitivity current: 30 mA)	
Communication function	Contact input/output (D-sub 25P, Female connector) Serial RS-485 (D-sub 9P, Female connector)			
External dimensions	mm 380 x 870 x 950			
Weight*11	kg 165 ±5			
Compliant standards	SEMI, CE/UKCA marking, UL			

- *1 No condensation should be present.
- *2 GALDEN® is a registered trademark, belonging to the Solvay Group or its corresponding owner. Fluorinert™ is a trademark of 3M.
- *3 Value with a stable load without turbulence in the operating conditions.
- *4 ① Facility water temperature: 25°C, ② Circulating fluid flow rate: Values at the rated circulating fluid flow rate. Values common for 50/60 Hz.
- *5 The capacity at the thermo-chiller outlet when the circulating fluid temperature is 20°C
- *6 The required flow rate for maintaining the cooling capacity or temperature stability. When used below the rated flow, use the individually sold, "Bypass Piping Set." (Refer to page 454).
- *7 May not be able to control with the set value depending on the piping specification in the user side.
- *8 Minimum volume required for operating only the thermo-chiller. (Circulating fluid temperature: 20°C, including the thermo-chiller's internal pipings or heat exchanger)
- *9 Preliminary space volume without main tank capacity. Available for collecting the circulating fluid inside an external piping or for preliminary injection.
- *10 Facility water temperature: 25°C. Flow rate required when the temperature setting is changed. The actual facility water flow rate will vary depending on the operating conditions.
- *11 Weight in the dry state without circulating fluids

Specifications

Model	HRZ002-W1S-F	HRZ004-W1S-F	HRZ008-W1S-F	HRZ010-W1S-F	HRZ002-W2S-F	HRZ004-W2S-F	HRZ008-W2S-F	HRZ010-W2S-F
Channel/Cooling method	1 channel/Water-cooled refrigeration				1 channel/Water-cooled refrigeration			
Temperature control method	PID control				PID control			
Refrigerant	R410A (HFC)				R410A (HFC)			
Refrigerant charge	1.5				1.5			
Ambient temperature	10 to 35				10 to 35			
Ambient humidity*1	30 to 70				30 to 70 (No condensation)			
Altitude	1000 or less				1000 or less			
Circulating fluid*2	60% ethylene glycol aqueous solution				Water			
Temperature range setting*1/	-10 to 90/±0.1				10 to 60/±0.1			
Temperature stability*3	-20 to 90/±0.1				10 to 60/±0.1			
Cooling capacity*4 (Under conditions below)	2	4 (2)	8 (4)	10 (4)	2	4	8	10
Circulating fluid temperature	20				20			
Facility water temperature	25				25			
Circulating fluid flow rate	20				20			
Pump capacity*5	0.40 (at 20 L/min) With flow control function by pump inverter				0.38 (at 20 L/min) With flow control function by pump inverter			
Rated flow*6	20				20			
Flow display range	10 to 40				10 to 40			
Flow range*7	10 to 40				10 to 40			
Discharge pressure display range	0 to 1.5				0 to 1.5			
Tank	Approx. 15				Approx. 15			
Main tank capacity*8	Approx. 16				Approx. 16			
Sub-tank capacity*9								
Contact material for circulating fluid	Stainless steel, EPDM, Copper brazing (Heat exchanger), Silicone, PPS, Fluororesin				Stainless steel, EPDM, Copper brazing (Heat exchanger), Silicone, PPS, Fluororesin			
Height difference between this product and user's equipment	10 or less				10 or less			
Outlet port size	Rc3/4 (With plug)				Rc3/4 (With plug)			
Return port size	Rc3/4 (With plug)				Rc3/4 (With plug)			
Drain port size	Rc3/8 (With valve/plug)				Rc3/8 (With valve/plug)			
Temperature	10 to 30				10 to 30			
Inlet pressure	0.3 to 0.7				0.3 to 0.7			
Inlet-outlet pressure differential of facility water	0.3 or more				0.3 or more			
Required flow rate*10	10	12	15		10	12	15	
Inlet port size	Rc1/2 (With plug)				Rc1/2 (With plug)			
Outlet port size	Rc1/2 (With plug)				Rc1/2 (With plug)			
Contact material for cooling water	Stainless steel, EPDM, Copper brazing (Heat exchanger), Silicone, Brass, NBR				Stainless steel, EPDM, Copper brazing (Heat exchanger), Silicone, Brass, NBR			
Voltage	3-phase 200 VAC/200 to 208 ±10 [%] (50/60 Hz)				3-phase 200 VAC/200 to 208 ±10 [%] (50/60 Hz)			
Max. operating current	15	22	22	25	15	18	21	25
Breaker capacity	20 (Earth leakage breaker sensitivity current: 30 mA)	30 (Earth leakage breaker sensitivity current: 30 mA)			20 (Earth leakage breaker sensitivity current: 30 mA)	30 (Earth leakage breaker sensitivity current: 30 mA)		
Communication function	Contact input/output (D-sub 25P, Female connector) Serial RS-485 (D-sub 9P, Female connector)				Contact input/output (D-sub 25P, Female connector) Serial RS-485 (D-sub 9P, Female connector)			
External dimensions	380 x 870 x 950				380 x 870 x 950			
Weight*11	165 ±5				165 ±5			
Compliant standards	SEMI, CE/UKCA marking, UL				SEMI, CE/UKCA marking, UL			

*1 No condensation should be present.

*2 Dilute pure ethylene glycol with tap water. Additives such as preservatives cannot be used. If water is used, about the water quality SMC recommends, please refer to "Specific Product Precautions". The minimum electric conductivity of the deionized water used as the fluid should be 0.5 μS/cm (or electric resistivity 2 MΩ·cm at maximum).

*3 Value with a stable load without turbulence in the operating conditions. It may be out of this range when a DI control kit (option Y) is used or in some other operating conditions.

*4 ① Facility water temperature: 25°C, ② Circulating fluid flow rate: Values at the rated circulating fluid flow rate. Values common for 50/60 Hz.

*5 The capacity at the thermo-chiller outlet when the circulating fluid temperature is 20°C

*6 The required flow rate for maintaining the cooling capacity or temperature stability. When used below the rated flow, use the individually sold, "Bypass Piping Set." (Refer to page 454).

*7 May not be able to control with the set value depending on the piping specification in the user side.

*8 Minimum volume required for operating only the thermo-chiller. (Circulating fluid temperature: 20°C, including the thermo-chiller's internal pipings or heat exchanger)

*9 Preliminary space volume without main tank capacity. Available for collecting the circulating fluid inside an external piping or for preliminary injection.

*10 Facility water temperature: 25°C. Flow rate required when the temperature setting is changed. The actual facility water flow rate will vary depending on the operating conditions.

*11 Weight in the dry state without circulating fluids

HRZ-F Series

Cooling Capacity

HRZ002/004/008/010-WS-F/W1S-F

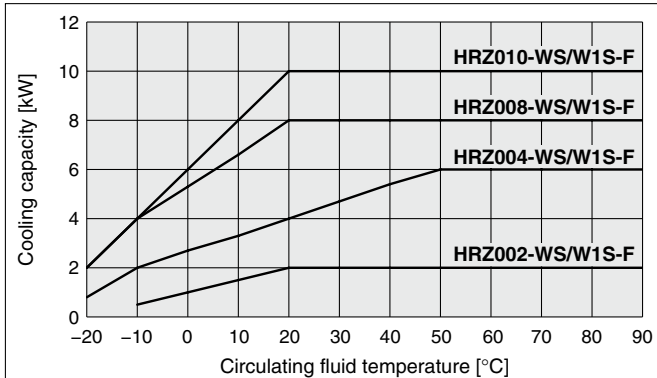

HRZ002/004/008/010-W2S-F

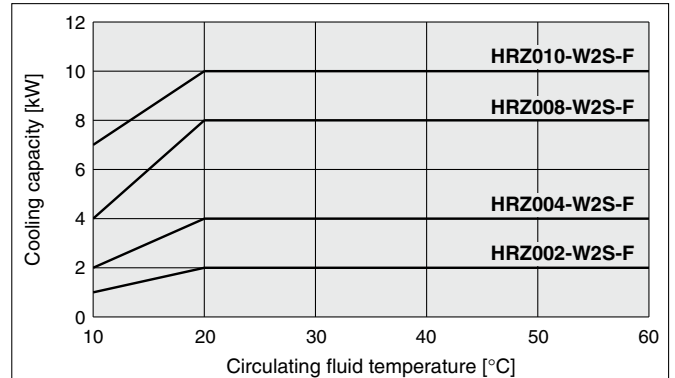

Heating Capacity

HRZ002/004/008/010-WS-F

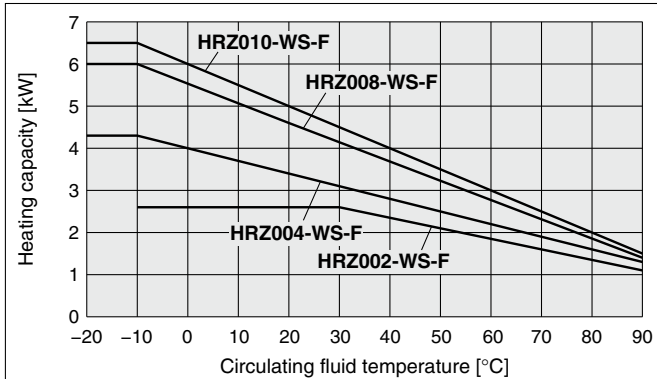

HRZ002/004/008/010-W1S-F

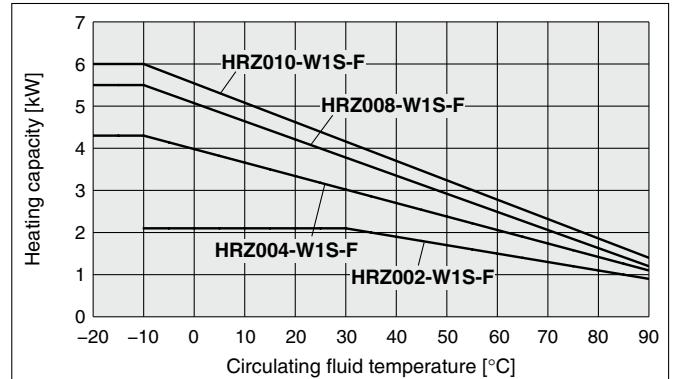

HRZ002/004/008/010-W2S-F

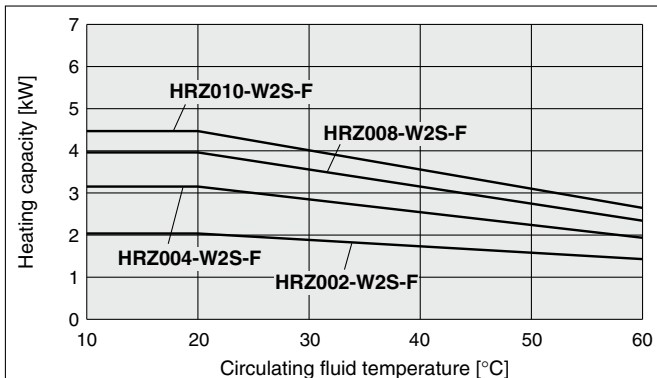

* When pump inverter is operating at frequency of 60 Hz (maximum).

Pump Capacity (Thermo-chiller Outlet)

HRZ002/004/008/010-WS-F Circulating fluid: FC-3283

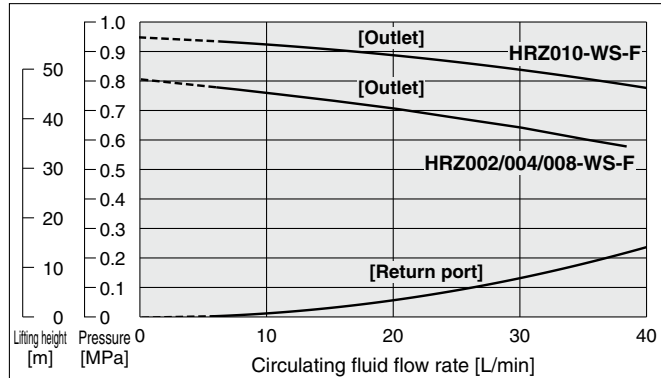

HRZ002/004/008/010-W1S-F

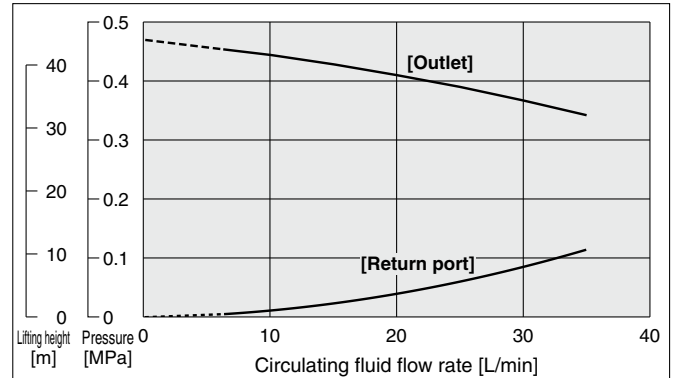

HRZ002/004/008/010-W2S-F

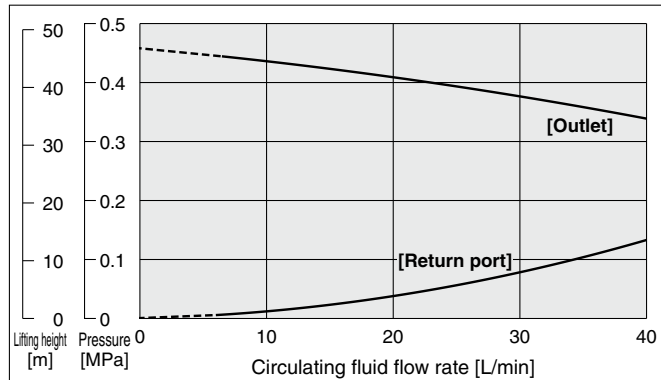

- * Circulating fluid temperature: 20°C
- When the operation of the inverter is at maximum frequency
- * When the circulating fluid flow is below 6 L/min, the in-built operation stop alarm will be activated. It is not possible to run the equipment. (common for all models)
- * With flow control function by inverter

EU F-Gas Regulation-compliant



Thermo-chiller Pump Inverter Type

HRZ-F Series

SEMI

RoHS

How to Order

Pump Inverter Type **HRZ008-L** - **F**

Cooling capacity

Symbol	Cooling capacity
008	8 kW

Temperature range setting

Symbol	Temperature range setting
L	-20 to 40°C

Circulating fluid type

Symbol	Circulating fluid
Nil	Fluorinated fluids
1	Ethylene glycol aqueous solution

Option 1 (Refer to page 452.)

Symbol	Contents
Nil	None
C	Analog communication
D	DeviceNet communication

• When multiple options are combined, indicate symbols in alphabetical order.

Option 2 (Refer to pages 452 and 453.)

Symbol	Contents
Nil	None
N	NPT fitting
W	SI unit only
Y*1	DI control kit
Z	Circulating fluid automatic recovery

• When multiple options are combined, indicate symbols in alphabetical order.

*1 Not equipped to the fluorinated fluid type.

• EU F-Gas Regulation-compliant

Specifications

Model	HRZ008-L-F	HRZ008-L1-F	
Channel/Cooling method	1 channel/Water-cooled refrigeration		
Temperature control method	PID control		
Refrigerant	R448A (HFC/HFO)		
Refrigerant charge	kg 2.0		
Ambient temperature	°C 10 to 35		
Ambient humidity*1	%RH 30 to 70		
Altitude	m 1000 or less		
Circulating fluid system	Circulating fluid*2	Fully fluorinated fluid Fluorinert™ FC-3283 GALDEN® HT135	60% ethylene glycol aqueous solution
	Temperature range setting*1/Temperature stability*3 °C	-20 to 40/±0.1	
	Cooling capacity*4 (Under conditions below) kW	8	
		Circulating fluid temperature °C	-10
	Facility water temperature °C	25	
	Circulating fluid flow rate L/min	30	20
	Pump capacity*5 MPa	0.95 (at 30 L/min) With flow control function by pump inverter	0.4 (at 30 L/min) With flow control function by pump inverter
	Rated flow*6 L/min	30	20
	Flow display range L/min	10 to 40	
	Flow range*7 L/min	15 to 40	10 to 40
Discharge pressure display range MPa	0 to 1.5		
Tank	Main tank capacity*8 L	Approx. 22	
	Sub-tank capacity*9 L	Approx. 17	
Contact material for circulating fluid	Stainless steel, EPDM, Copper brazing (Heat exchanger), Silicone, PPS, Fluororesin		
Height difference between this product and user's equipment m	10 or less		
Outlet port size	Rc3/4 (With plug)		
Return port size	Rc3/4 (With plug)		
Drain port size	Rc3/8 (With valve/plug)		
Cooling water system	Temperature °C	10 to 25	
	Inlet pressure MPa	0.3 to 0.7	
	Inlet-outlet pressure differential of facility water MPa	0.3 or more	
	Required flow rate*10 L/min	18/23 (50/60 Hz)	
	Inlet port size	Rc1/2 (With plug)	
	Outlet port size	Rc1/2 (With plug)	
Contact material for cooling water	Stainless steel, EPDM, Copper brazing (Heat exchanger), Silicone, Brass, NBR		
Electrical system	Voltage V	3-phase 200 VAC/200 to 208 ±10 [%] (50/60 Hz)	
	Max. operating current A	46	
	Breaker capacity A	60 (Earth leakage breaker sensitivity current: 30 mA)	
	Communication function	Contact input/output (D-sub 25P, Female connector) Serial RS-485 (D-sub 9P, Female connector)	
External dimensions mm	415 x 1080 x 1075		
Weight*11 kg	236 ±5		
Compliant standards	SEMI, CE/UKCA marking, UL		

*1 No condensation should be present.

*2 GALDEN® is a registered trademark, belonging to the Solvay Group or its corresponding owner. Fluorinert™ is a trademark of 3M. Dilute pure ethylene glycol with tap water. Additives such as preservatives cannot be used.

*3 Value with a stable load without turbulence in the operating conditions. It may be out of this range when a DI control kit (option Y) is used or in some other operating conditions.

*4 ① Facility water temperature: 25°C, ② Circulating fluid flow rate: Values at the rated circulating fluid flow rate. Values common for 50/60 Hz.

*5 The capacity at the thermo-chiller outlet when the circulating fluid temperature is 20°C

*6 The required flow rate for maintaining the cooling capacity or temperature stability. When used below the rated flow, use the individually sold, "Bypass Piping Set." (Refer to page 454).

*7 May not be able to control with the set value depending on the piping specification in the user side.

*8 Minimum volume required for operating only the thermo-chiller. (Circulating fluid temperature: 20°C, including the thermo-chiller's internal pipings or heat exchanger)

*9 Preliminary space volume without main tank capacity. Available for collecting the circulating fluid inside an external piping or for preliminary injection.

*10 The required flow rate when the cooling capacity load is applied at a facility water temperature of 25°C. The actual facility water flow rate will vary depending on the operating conditions.

*11 Weight in the dry state without circulating fluids

Cooling Capacity

HRZ008-L-F/HRZ008-L1-F

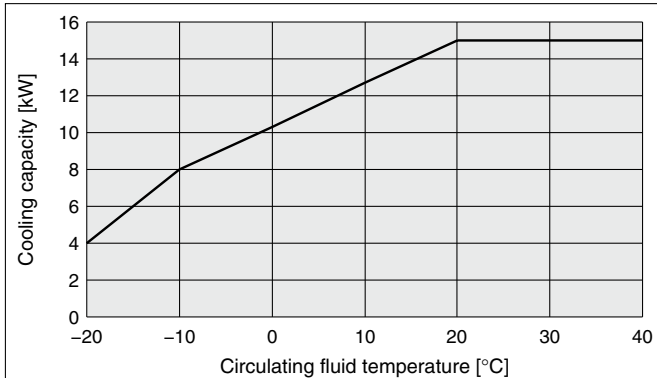

Heating Capacity

HRZ008-L-F

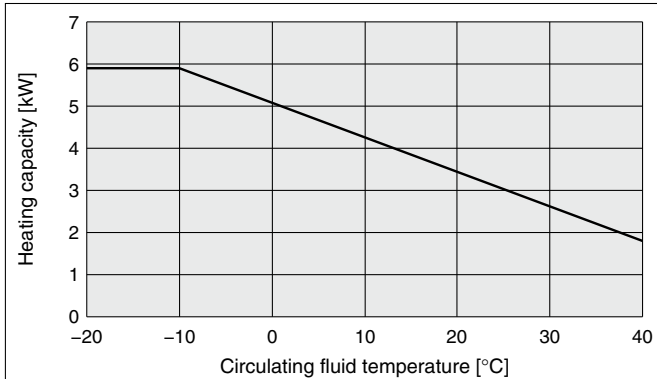

HRZ008-L1-F

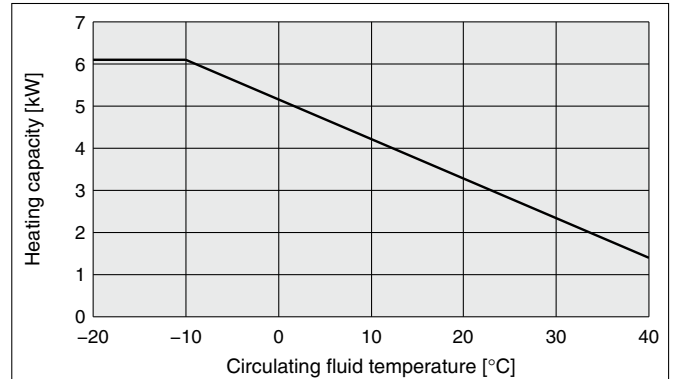

* When pump inverter is operating at frequency of 60 Hz (maximum).

Pump Capacity (Thermo-chiller Outlet)

HRZ008-L-F

Circulating fluid: FC-3283

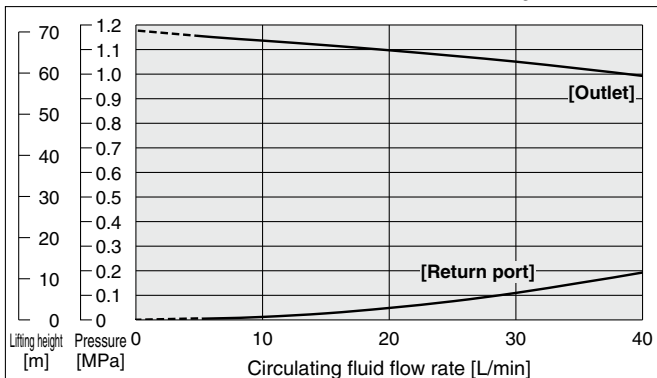

HRZ008-L1-F

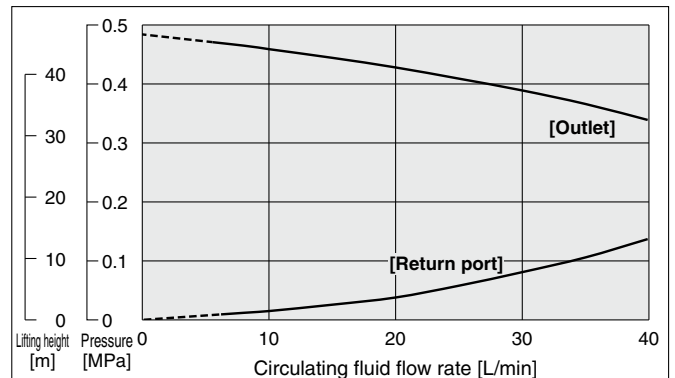

* Circulating fluid temperature: 20°C

When the operation of the inverter is at maximum frequency

* When the circulating fluid flow is below 6 L/min, the in-built operation stop alarm will be activated.

It is not possible to run the equipment. (common for all models)

* With flow control function by inverter

HRZ-F Series

Dimensions

HRZ002-WS-F/HRZ002-W1S-F/HRZ002-W2S-F
 HRZ004-WS-F/HRZ004-W1S-F/HRZ004-W2S-F
 HRZ008-WS-F/HRZ008-W1S-F/HRZ008-W2S-F
 HRZ010-WS-F/HRZ010-W1S-F/HRZ010-W2S-F

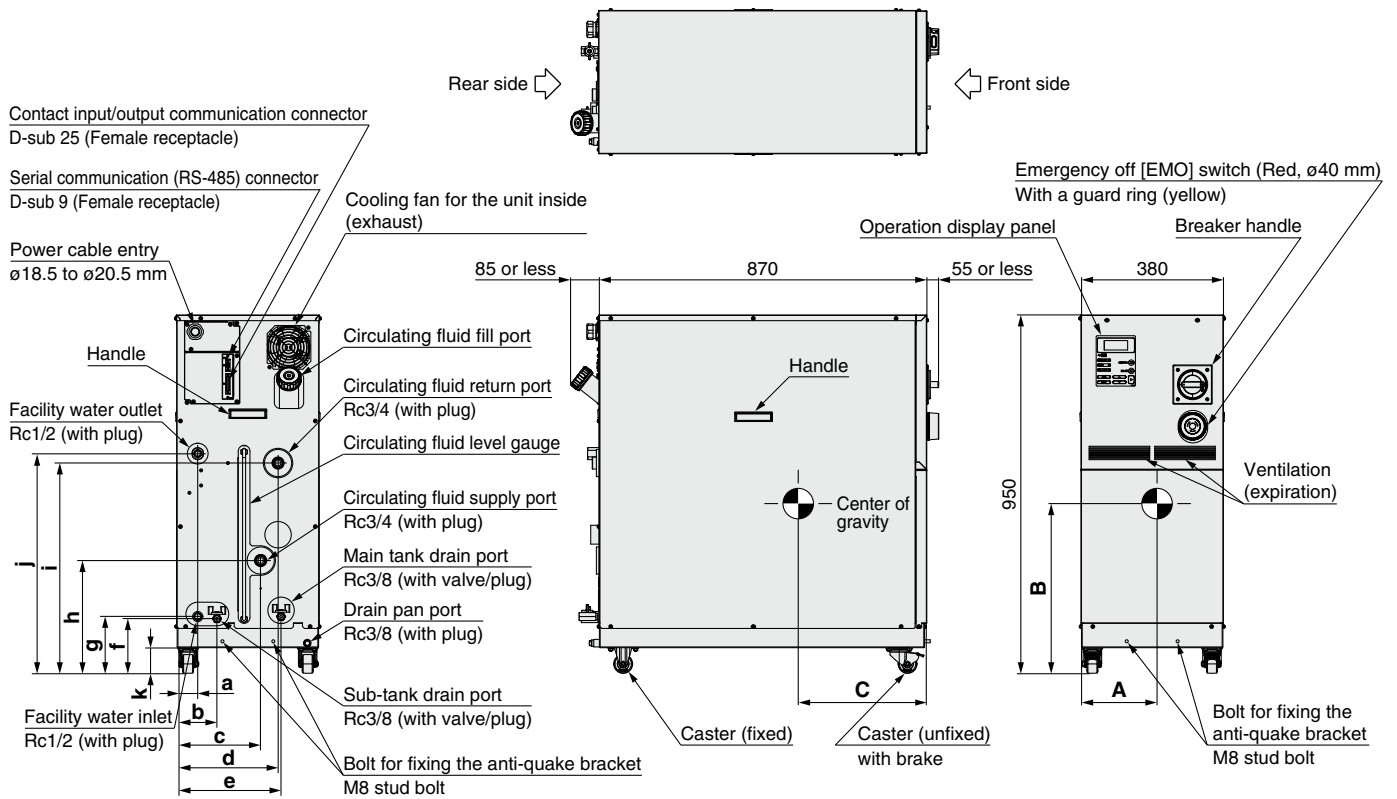

													[mm]	
A	B	C	a	b	c	d	e	f	g	h	i	j	k	Weight [kg]
205	439	450	57	108	224	270	278	145	151	299	558	583	68	165 ± 5

* Dimensional tolerance: ± 10 mm

* The product weight does not include the weight of circulating fluid; the weight refers to the product in a dry state.

Dimensions

HRZ008-L-F, HRZ008-L1-F

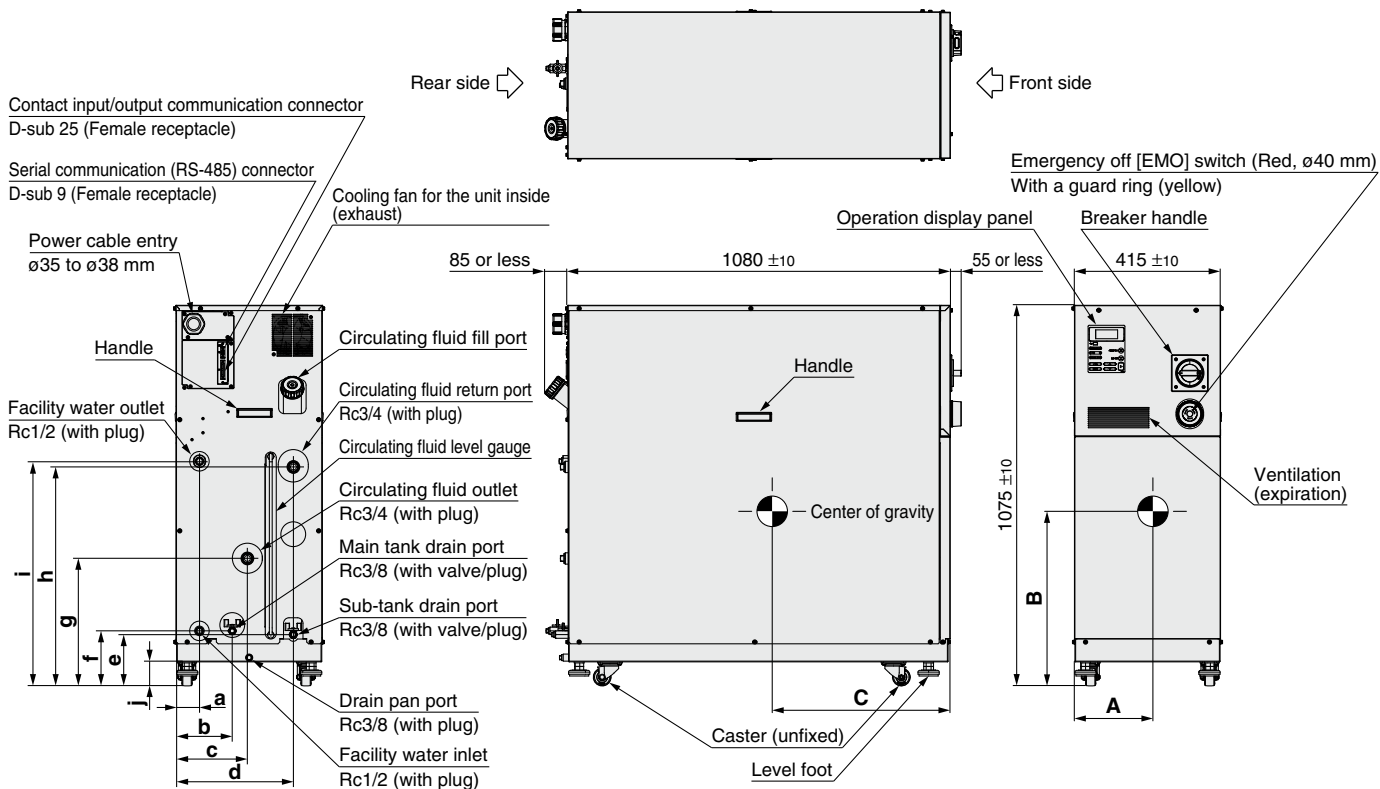

Anti-quake bracket mounting position (Dimensional tolerance: ± 5 mm)

* Anchor bolts (M8, 8 pcs.) which are suitable for the floor material should be prepared by user.

													[mm]	
A	B	C	a	b	c	d	e	f	g	h	i	j	Weight [kg]	* Dimensional tolerance: ± 10 mm
215	443	427	67	160	203	332	145	156	360	619	635	68	236 ± 5	* The product weight does not include the weight of circulating fluid; the weight refers to the product in a dry state.

HRZ-F Series

Communication Functions (For details, please refer to our "Communication Specifications" information.)

Contact Input/Output

Item		Specifications
Connector no.		P1
Connector type (on this product's side)		D-sub 25 P type, Female connector (M2.6 x 0.45 screw fixed type)
Input signal	Insulation method	Photocoupler
	Rated input voltage	24 VDC
	Rated input current	5 mA TYP
	Input impedance	4.7 kΩ
Contact output signal	Rated load voltage	48 VAC or less/30 VDC or less
	Maximum load current*1	800 mA AC/DC (Resistance load/Inductive load)

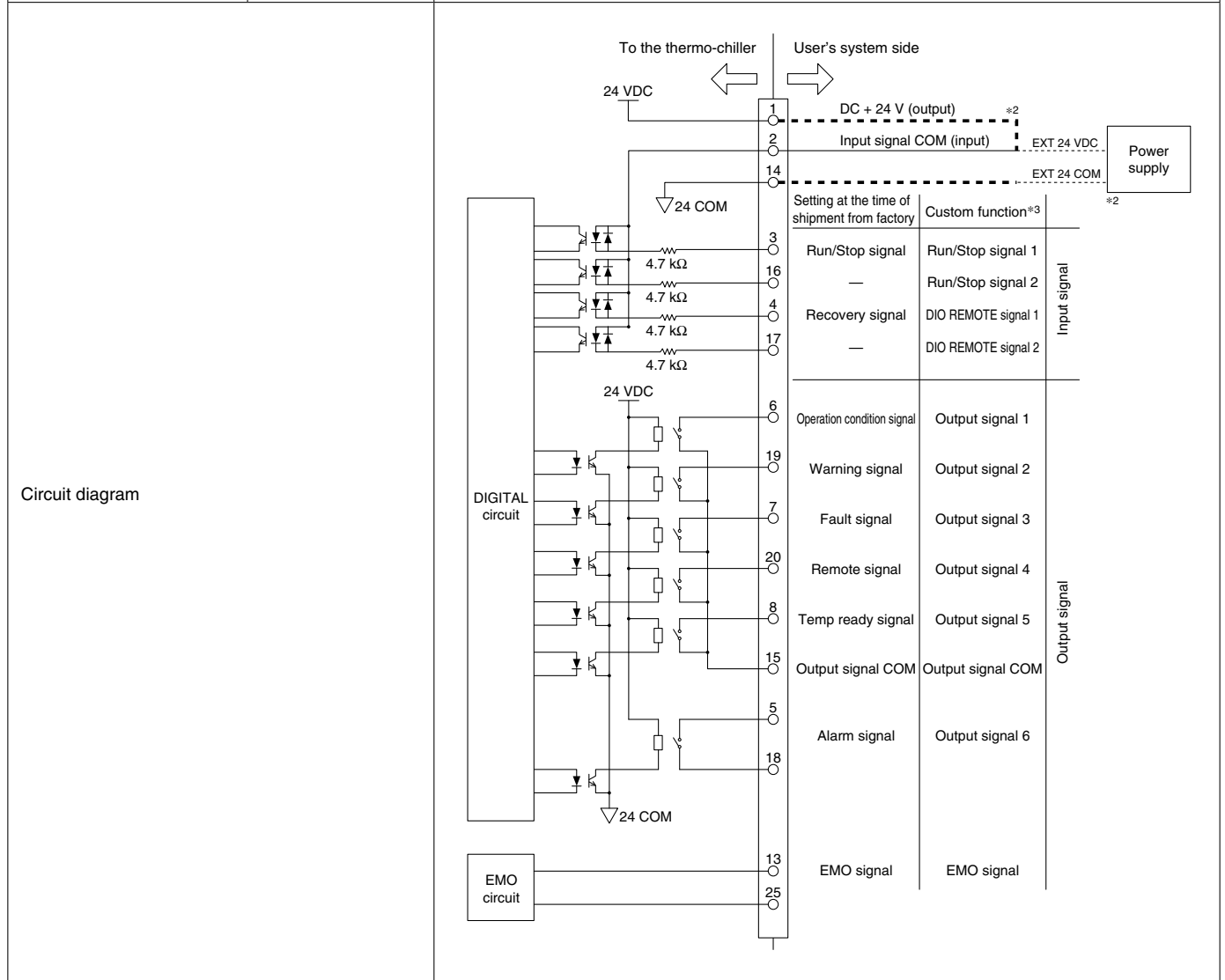

*1 When Common uses a common signal, the total load must be 800 mA or less.

*2 When the power supply of the thermo-chiller is used, connect pin No. 1 to pin No. 2, and the COM side of contact input signals to pin No. 14. When user's power supply is used, connect the + side of 24 VDC to pin No. 2 and connect the COM side of contact input signals to the COM of the user's system power supply. Incorrect connection leads to malfunction.

*3 The custom function is equipped for contact input/output. Using the custom function enables the user to set the signal type for contact input/output or pin assignment numbers. For details, please refer to the "Communication Specifications" information.

Serial RS-485

The serial RS-485 enables the following items to be written and read out.

<Writing>

Run/Stop

Circulating fluid temperature setting

Circulating fluid automatic recovery start/stop*1

<Readout>

Circulating fluid present temperature

Circulating fluid flow

Circulating fluid discharge pressure

Circulating fluid electric resistivity*2

Alarm occurrence information

Status (operating condition) information

*1 Only when the circulating fluid automatic recovery function (option Z) is selected.

*2 Only when the DI control kit (option Y) is selected.

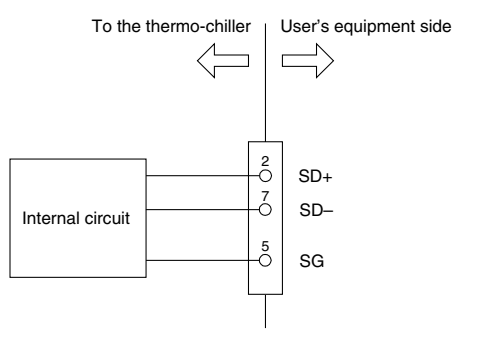
Item	Specifications
Connector no.	P2
Connector type (on this product's side)	D-sub 9 P type, Female connector
Fixing bolt size	M2.6 x 0.45
Standards	EIA RS485
Protocol	Modicon Modbus
Circuit diagram	

Connector Location

Serial communication (RS-485) connector
D-sub 9 (Female receptacle)

Contact input/output communication connector
D-sub 25 (Female receptacle)

Power cable entry

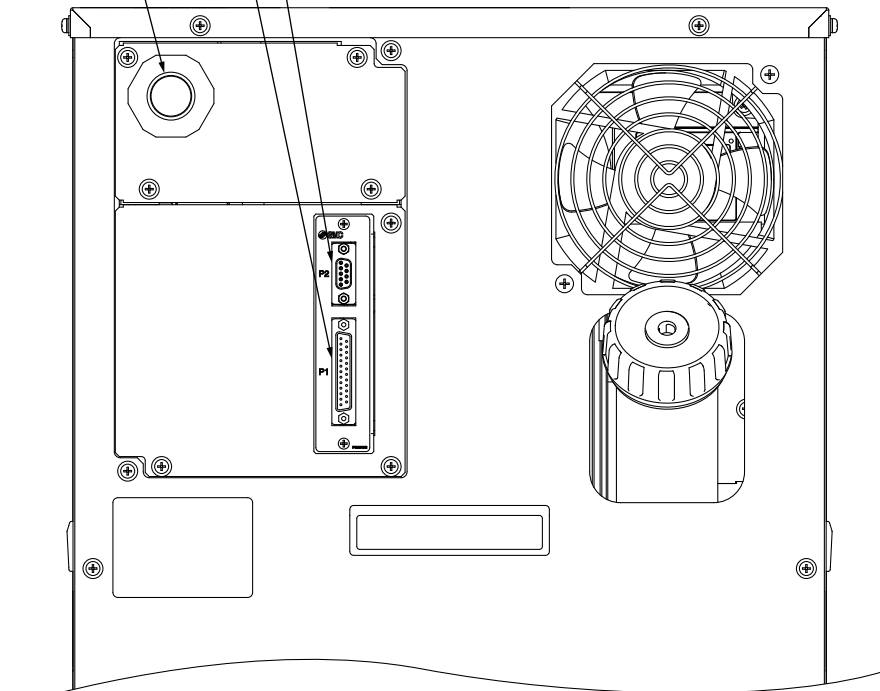

Rear side

HRZ-F Series

Operation Display Panel

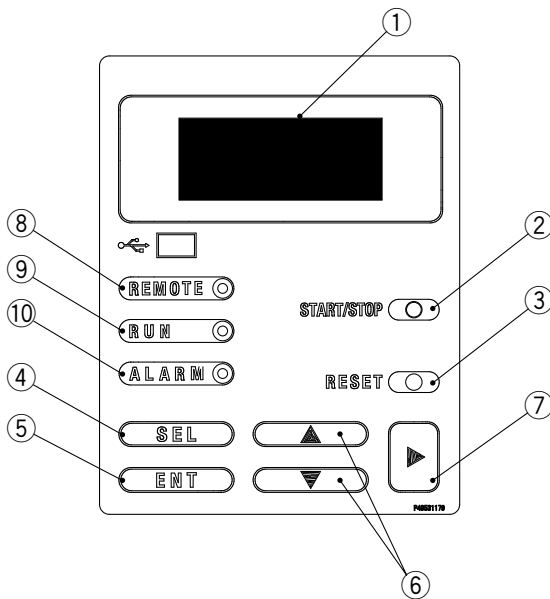

No.	Description	Function
①	LCD	Operating condition of this unit/Circulating fluid discharge temperature/Circulating fluid flow/Circulating fluid discharge pressure/Setting value/Alarm message, etc. are displayed.
②	[START/STOP] key	Starts/Stops the operation.
③	[RESET] key	Stops the alarm buzzing. Resets the alarm.
④	[SEL] key	Switches the display.
⑤	[ENT] key	Decides the settings.
⑥	[▲] [▼] key	Moves the cursor and changes the setting values.
⑦	[▶] key	Moves the cursor.
⑧	[REMOTE] lamp	Lights up when the unit is in the remote status.
⑨	[RUN] lamp	Lights up when the unit is in the operating status.
⑩	[ALARM] lamp	Lights up when the unit is alarming.

Alarm

This unit can display 24 kinds of alarm messages as standard. Also, it can read out the serial RS-485 communication.

Alarm code	Alarm message	Operation status	Main reason
01	Water Leak Detect FLT	Stop	Liquid deposits in the base of this unit.
02*2	Incorrect Phase Error FLT	Stop	The power supply to this unit is incorrect.
03	RFGT High Press FLT	Stop	Pressure in the refrigeration circuit has exceeded the limitation.
04	CPRSR Overheat FLT	Stop	Temperature inside the compressor has increased.
05	Reservoir Low Level FLT	Stop	The amount of circulating fluid is running low.
06	Reservoir Low Level WRN	Continue	The amount of circulating fluid is running low.
07	Reservoir High Level WRN	Continue	Filling the circulating fluid too much.
08	Temp. Fuse Cutout FLT	Stop	Temperature of the circulating fluid tank is raised.
09	Reservoir High Temp. FLT	Stop	Temperature of the circulating fluid has exceeded the limitation.
10	Return High Temp. WRN	Continue	Temperature of returning circulating fluid has exceeded the limit.
11	Reservoir High Temp. WRN	Continue	Temperature of the circulating fluid has exceeded the limitation set by user.
12	Return Low Flow FLT	Stop	The circulating fluid flow has gone below 6 L/min.
13	Return Low Flow WRN	Continue	The circulating fluid flow has gone below the limitation set by user.
16*2	CPRSR Breaker Trip FLT	Stop	Protection device for the electric circuit of the compressor is activated.
19	FAN Motor Stop WRN	Continue	Cooling fan inside the compressor has stopped.
20	Internal Pump Time Out WRN	Continue	The internal pump continuously run for more than a certain period of time.
21	Controller Error FLT	Stop	The error occurred in the control systems.
22	Memory Data Error FLT	Stop	The data stored in the controller of this unit went wrong.
23*4	Communication Error	Continue/Stop	The serial communications between this unit and user's system has been suspended.
24*1	DI Low Level WRN	Continue	DI level of the circulating fluid has gone below the limitation set by user.
25	Pump Inverter Error FLT	Stop	An error has occurred in the inverter for the circulating pump.
28*3	CPRSR INV Error FLT	Stop	An error has occurred in the inverter for the compressor.
29	RFGT Low Press FLT	Stop	The refrigerant pressure has gone below the limitation.
32	Reservoir Low Temp. WRN	Continue	The temperature for circulating fluid return has gone below the limitation set by the user.

*1 Only for the DI control kit (option Y) specification

*2 HRZ008-L/L1-F only

*3 Excluding HRZ008-L/L1-F

*4 Continue or stop can be selected.

HRZ-F Series Options

* Options have to be selected when ordering the thermo-chiller. It is not possible to add them after purchasing the unit.

C Option symbol Analog Communication

HRZ - - - C F

Analog communication

In addition to the standard contact input/output signal communication and the serial RS-485 communication, analog communication function can be added.

The analog communication function enables to write and read out the following items.

<Writing>	<Readout>
Circulating fluid temperature setting	Circulating fluid present temperature
	Electric resistivity* ¹

*¹ Only when the DI control kit (option Y) is selected.

Scaling voltage - circulating fluid temperature can be set arbitrarily by user.

For details, please refer to our "Communication Specifications" information.

N Option symbol NPT Fitting

HRZ - - - F N

NPT fitting

An adapter is included to change the connection parts of circulating fluid piping and facility water piping to NPT thread type. The adapter must be installed by user.

Y Option symbol DI Control Kit

HRZ - - - F Y

DI control kit

Select this option if you want to maintain the electric resistance ratio (DI level) of the circulating fluid at a certain level. However, some components have to be fitted by user. For details, refer to specification table for this option.

Please note that this is not applicable to the fluorinated liquid type.

D Option symbol DeviceNet Communication

HRZ - - - D F

DeviceNet communication

DeviceNet[®]

■ Trademark

DeviceNet[®] is a registered trademark of ODVA, Inc.

In addition to the standard contact input/output signal communication and the serial RS-485 communication, DeviceNet function can be added. DeviceNet function enables to write and read out the following items.

<Writing>	<Readout>
Run/Stop	Circulating fluid present temperature
Circulating fluid temperature setting	Circulating fluid flow
Circulating fluid automatic recovery start/stop* ¹	Circulating fluid discharge pressure
	Electric resistivity* ²
	Alarm occurrence information
	Status (operating condition) information

*¹ Only when the circulating fluid automatic recovery function (option Z) is selected.

*² Only when the DI control kit (option Y) is selected.

For details, please refer to our "Communication Specifications" information.

W Option symbol SI Unit Only

HRZ - - - F W

SI unit only

The circulating fluid flow rate and pressure are displayed in SI units [LPM/MPa] only.

If this option is not selected, a product with a unit selection function will be provided by default.

* No change in external dimensions

Applicable model	HRZ00 <input type="text"/> -W1S-FY HRZ010-W1S-FY HRZ008-L1-FY	HRZ00 <input type="text"/> -W2S-FY HRZ010-W2S-FY
Allowable circulating fluid	—	60% ethylene glycol aqueous solution
DI level display range	MΩ·cm	0 to 20* ¹
DI level set range	MΩ·cm	0 to 2.0* ²
Solenoid valve hysteresis or control	MΩ·cm	0 to 0.9
DI level reduction alarm set range	MΩ·cm	0 to 2.0
DI circuit rated flow	L/min	Approx. 1.5 (When the circulating fluid flow rate on the user's system side is 20 L/min)
Contact material for circulating fluid* ³	—	FKM

*¹ The DI level display value is the value without temperature correction.

*² The DI filter is needed to control the DI level. (SMC Part No.: HRZ-DF001)

Please purchase additionally because the DI filter is not included in this option. In addition, when the product is to be used outside of the 20 to 40°C range, be sure to purchase the insulating material for the DI filter (SMC part no.: HRZ-DF002) to prevent frostbite and burns.

*³ The additional contact material when this option is mounted

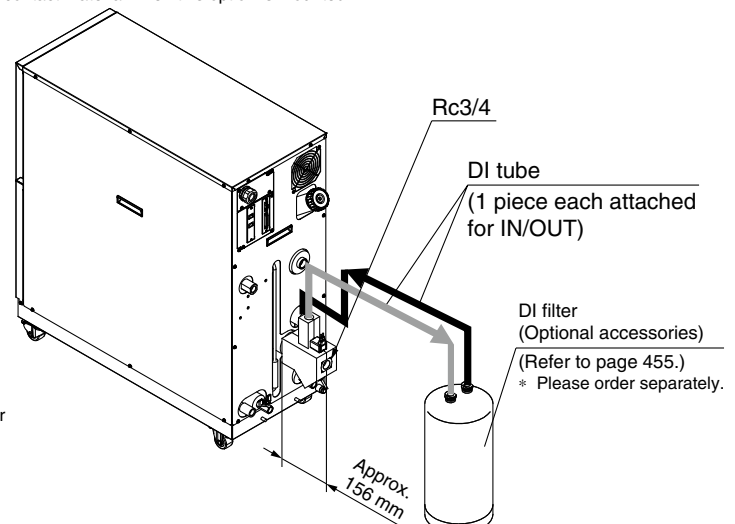

* Install the DI filter outside the thermo-chiller for piping. Secure the space for installing the DI filter on the rear side of the thermo-chiller.

* It may go outside of the temperature stability range of ±0.1°C when this option is used in some operating conditions.

HRZ-F Series

Z Option symbol

Circulating Fluid Automatic Recovery

HRZ - - F Z

Circulating fluid
automatic recovery

Select this option for users who want to use the circulating fluid automatic recovery function. The automatic recovery function is a device which can recover the circulating fluid inside pipings into a sub-tank of the thermo-chiller by the external communication or operating display panel. Some components need to be fitted by user. For details, please refer to the "Product Specifications" information for these options.

Applicable model		HRZ002-WS-FZ/HRZ002-W1S-FZ/HRZ002-W2S-FZ HRZ004-WS-FZ/HRZ004-W1S-FZ/HRZ004-W2S-FZ HRZ008-WS-FZ/HRZ008-W1S-FZ/HRZ008-W2S-FZ HRZ010-WS-FZ/HRZ010-W1S-FZ/HRZ010-W2S-FZ	HRZ008-L-FZ HRZ008-L1-FZ
Circulating fluid recoverable volume*1	L	16	17
Purge gas	—	Nitrogen gas, Compressed air*2	
Purge gas supply port	—	Self-align fitting for O.D. ø8*3	
Purge gas supply pressure	MPa	0.4 to 0.7	
Purge gas filtration	µm	0.01 or less	
Regulator set pressure	MPa	0.15 to 0.3*4	
Recoverable circulating fluid temperature	°C	10 to 30	
Recovery operation	—	Serial RS-485, contact input/output, or operation display panel*5	
Automatic recovery stop mode	sec	AUTO: After recovery completion, recovery is automatically stopped. (Factory setting) TIME: Recovery is continued for a set period of time. (Settable range: 1 to 600, Factory setting: 300)	
Contact material for circulating fluid*6	—	FKM	
Height difference with the user's system side	m	15 or less	

- *1 This is the preliminary space volume when the liquid level is "High." The main tank capacity is not included. Do not allow the amount of fluid in the external piping to exceed the capacity of the circulating fluid recovery tank.
- *2 Use compressed air with a dew point of -30°C or less. If compressed air with a high dew point is used, condensation will be generated in the tank when operated at low temperatures, which may result in cooling failure and other malfunctions. Be sure to confirm that there are no chemicals, synthetic oils that include organic solvents, salt, corrosive gases, etc., in the compressed air.
In addition, if a lubricator is used on the compressed air supply side, the bleed hole of the regulator may become clogged, resulting in malfunction.
- *3 Before piping, clean inside the pipings with air blow, etc. Use the piping with no dust generation by purge gas. When using resin tube, where necessary, use insert fittings, etc. in order not to deform the tubings when connecting to self-align fittings.
- *4 At the time of shipping from factory, it is set to 0.2 MPa.
- *5 Refer to the thermo-chiller operation manual and the communication specifications manual for details.
- *6 The additional contact material when this option is mounted

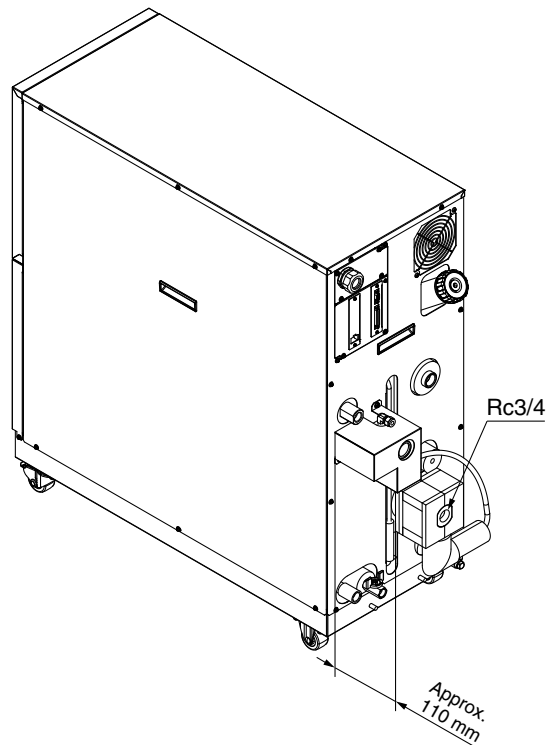

HRZ-F Series Optional Accessories

① Bypass Piping Set

* Necessary to be fitted by user.

When the circulating fluid goes below the rated flow, cooling capacity will be reduced and the temperature stability will be badly affected. In such a case, use the bypass piping set.

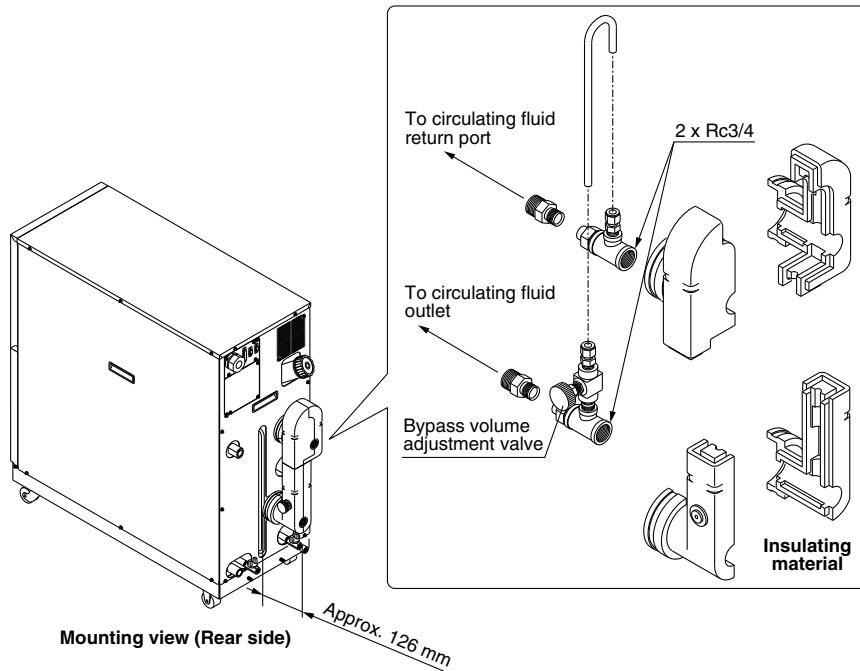

Part no.	Applicable model
HRZ-BP002	HRZ002-WS-F/HRZ002-W1S-F/ HRZ002-W2S-F
	HRZ004-WS-F/HRZ004-W1S-F/ HRZ004-W2S-F
	HRZ008-WS-F/HRZ008-W1S-F/ HRZ008-W2S-F
	HRZ010-WS-F/HRZ010-W1S-F/ HRZ010-W2S-F
HRZ-BP008	HRZ008-L-F/HRZ008-L1-F

② Anti-quake Bracket

Bracket for earthquakes
Prepare the anchor bolts (M12) which are suited to the floor material by user.

Part no.	Applicable model
HRZ-TK002	HRZ002-WS-F/HRZ002-W1S-F/HRZ002-W2S-F
	HRZ004-WS-F/HRZ004-W1S-F/HRZ004-W2S-F
	HRZ008-WS-F/HRZ008-W1S-F/HRZ008-W2S-F
	HRZ010-WS-F/HRZ010-W1S-F/HRZ010-W2S-F

* 2 pieces per set (for 1 unit) (HRZ-TK002)

* Anti-quake bracket is attached as standard. (HRZ008-L-F, HRZ008-L1-F)

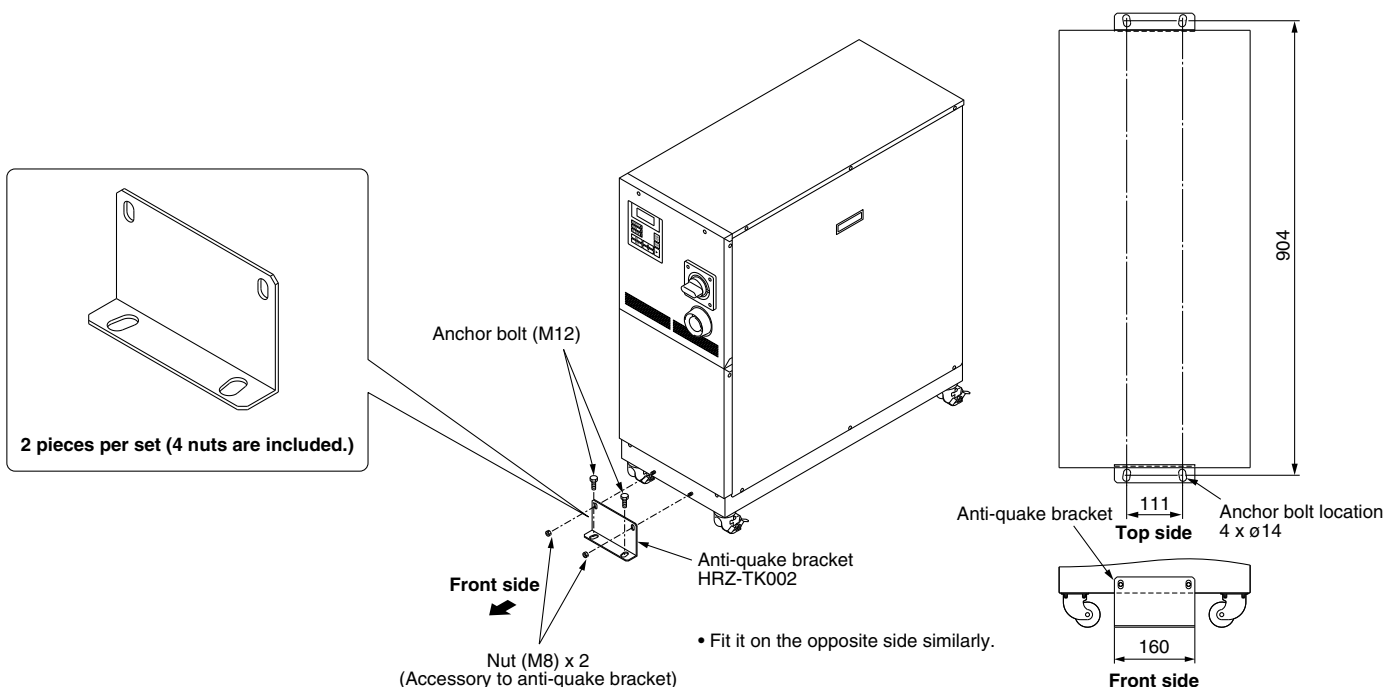

HRZ-F Series

③ 4-Port Manifold

4-branching the circulating fluid enables 4 temperature controls at the maximum with the 1 unit thermo-chiller.

Part no.	Applicable model
HRZ-MA001	Common for all models

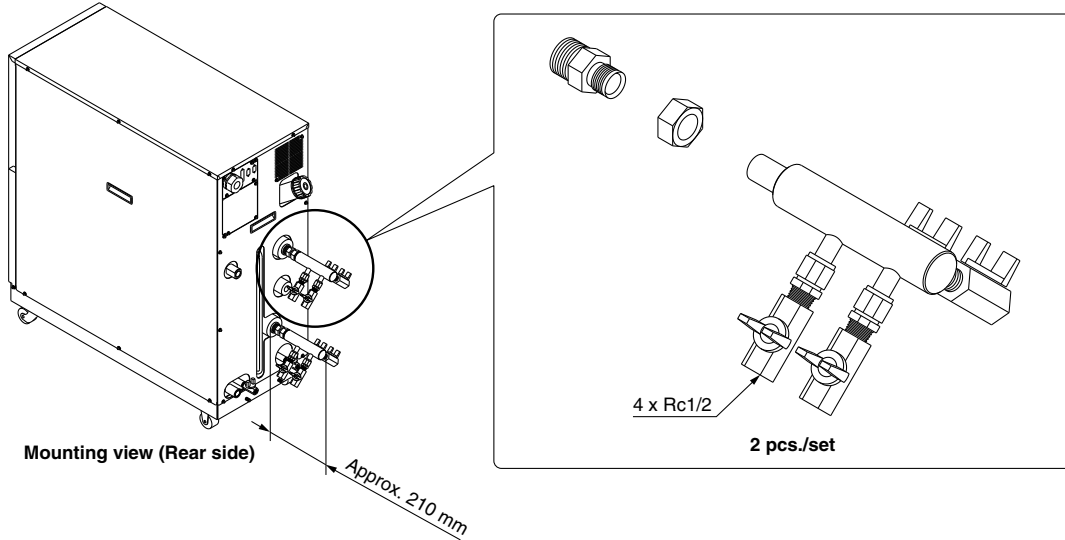

④ DI Filter

This is the ion replacement resin to maintain the electric resistivity of the circulating fluid. Users who selected the DI control kit (option Y) need to purchase the DI filter separately.

Part no.	Applicable model
HRZ-DF001	Common for all models which can select the DI control kit. (option Y)

* The DI filters are consumable. Depending on the status (electric resistivity set value, circulating fluid temperature, piping volume, etc.), product life cycles will vary accordingly.

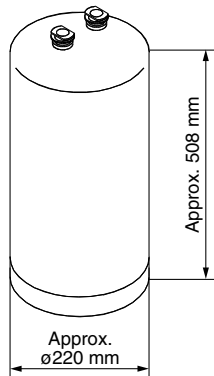

Weight: Approx. 20 kg

⑤ Insulating Material for DI Filter

When the DI filter is used at a high-temperature, we recommend that you use this insulating material to protect the radiated heat from the DI filter or possible burns. When the DI filter is used at a low-temperature, we also recommend that you use this to prevent heat absorption from the DI filter and to avoid forming condensation.

Part no.	Applicable model
HRZ-DF002	Common for all models which can select the DI control kit. (option Y)

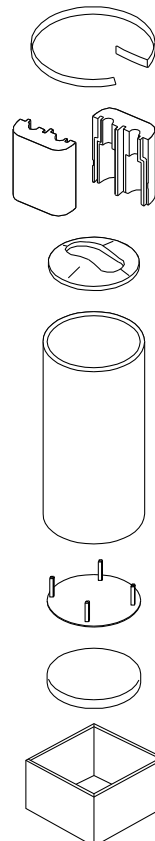

⑥ 60% Ethylene Glycol Aqueous Solution

This solution can be used as a circulating fluid for ethylene glycol-type thermo-chillers. (Capacity: 10 L)

Part no.	Applicable model
HRZ-BR001	Common for all ethylene glycol-type models

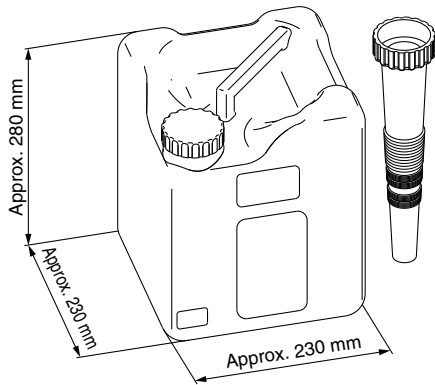

⑦ Concentration Meter

This meter can be used to control the condensation of ethylene glycol solution regularly.

Part no.	Applicable model
HRZ-BR002	Common for all ethylene glycol-type models

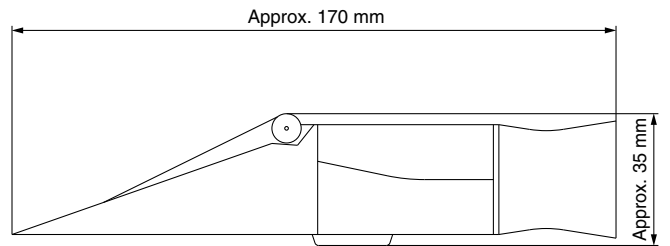



HRZ-F Series

Specific Product Precautions 1

Be sure to read this before handling the products. For safety instructions and temperature control equipment precautions, refer to the “Handling Precautions for SMC Products” and the “Operation Manual” on the SMC website: <https://www.smcworld.com>

Design

⚠ Warning

- This catalog shows the specifications of a single unit.**
 - For details, please refer to our “Product Specifications” and thoroughly consider the adaptability between the user’s system and this unit.
 - Although a protection circuit as a single unit is installed, the user is requested to carry out a safety design for the whole system.

Selection

⚠ Caution

- Model selection**
In order to select the correct thermo-chiller model, the amount of thermal generation from the user’s system, the operating circulating fluid, and its circulating flow are required. Select a model, by referring to the guideline to model selection on page 437.
- Option selection**
Options have to be selected when ordering the thermo-chiller. It is not possible to add them after purchasing the unit.

Handling

⚠ Warning

- Thoroughly read the operation manual.**
Read the operation manual completely before operation, and keep the manual where it can be referred to as necessary.

Operating Environment / Storage Environment

⚠ Caution

- Do not use in the following environment because it will lead to a breakdown.**
 - Environment like written in “Temperature Control Equipment Precautions.”
 - Locations where spatter will adhere to when welding.
 - Locations where it is likely that the leakage of flammable gas may occur.
 - Locations where the ambient temperature exceeds the limits as mentioned below.
 - During operation 10°C to 35°C
 - During storage 0°C to 50°C (but as long as water or circulating fluid are not left inside the pipings)
 - Locations where the ambient relative humidity exceeds the limit as mentioned below.
 - During operation 30% to 70%
 - During storage 15% to 85%
 - (Inside the operation facilities) locations where there is not sufficient space for maintenance.
 - In locations where the ambient pressure exceeds the atmospheric pressure.
- The Thermo-chiller does not have clean room specification. It generates dust from the pump inside the unit and the cooling fan for the unit inside.**

Circulating Fluid

⚠ Caution

- Avoid oil or other foreign matter entering the circulating fluid.**
- Use ethylene glycol that does not contain additives such as preservatives.**
- The condensation of ethylene glycol aqueous solution must be 60% or less. If the density is too high, the pump will be overloaded, resulting in occurrence of “Pump Breaker Trip FLT.” Also, if the density is too low, the unit will freeze at lower temperatures, resulting in product failure.**
- Avoid water moisture entering the fluorinated fluid. Otherwise, the unit will freeze, resulting in product failure.**
- Use water (including for diluting ethylene glycol aqueous solution) which must meet the water quality standards as mentioned below.**

Water (as Circulating Water) Quality Standards

SMC recommends satisfying the water quality standards of the Japan Refrigeration and Air Conditioning Industry Association (JRA GL-02-1994 / Cooling water system - Recirculation type - Make-up water)

	Item	Unit	Standard value	Influence	
				Corrosion	Scale generation
Standard item	pH (at 25°C)	—	6.0 to 8.0	○	○
	Electric conductivity (25°C)	[μS/cm]	100*1 to 300*1	○	○
	Chloride ion (Cl ⁻)	[mg/L]	50 or less	○	
	Sulfuric acid ion (SO ₄ ²⁻)	[mg/L]	50 or less	○	
	Acid consumption amount (at pH4.8)	[mg/L]	50 or less		○
	Total hardness	[mg/L]	70 or less		○
	Calcium hardness (CaCO ₃)	[mg/L]	50 or less		○
	Ionic state silica (SiO ₂)	[mg/L]	30 or less		○
Reference item	Iron (Fe)	[mg/L]	0.3 or less	○	○
	Copper (Cu)	[mg/L]	0.1 or less	○	
	Sulfide ion (S ₂ ⁻)	[mg/L]	Should not be detected.	○	
	Ammonium ion (NH ₄ ⁺)	[mg/L]	0.1 or less	○	
	Residual chlorine (Cl)	[mg/L]	0.3 or less	○	
	Free carbon (CO ₂)	[mg/L]	4.0 or less	○	

*1 In the case of [MΩ·cm], it will be 0.003 to 0.01.

○: Factors that have an effect on corrosion or scale generation.

• Even if the water quality standards are met, complete prevention of corrosion is not guaranteed.



HRZ-F Series

Specific Product Precautions 2

Be sure to read this before handling the products. For safety instructions and temperature control equipment precautions, refer to the “Handling Precautions for SMC Products” and the “Operation Manual” on the SMC website: <https://www.smcworld.com>

Facility Water Supply

Warning

<Water-cooled refrigeration>

1. The water-cooled refrigeration type thermo-chiller radiates heat to the facility water.

Prepare the facility water system that satisfies the facility water specifications below.

2. When using tap water as facility water, SMC recommends the water quality shown in the following table as reference.

<Tap Water (as Facility Water) Quality Standards>

The Japan Refrigeration and Air Conditioning Industry Association
JRA GL-02-1994 “Cooling water system – Circulation type – Circulating water”

	Item	Unit	Standard value	Influence	
				Corrosion	Scale generation
Standard item	pH (at 25°C)	—	6.5 to 8.2	○	○
	Electric conductivity (25°C)	[μS/cm]	100*1 to 800*1	○	○
	Chloride ion (Cl ⁻)	[mg/L]	200 or less	○	
	Sulfuric acid ion (SO ₄ ²⁻)	[mg/L]	200 or less	○	
	Acid consumption amount (at pH4.8)	[mg/L]	100 or less		○
	Total hardness	[mg/L]	200 or less		○
	Calcium hardness (CaCO ₃)	[mg/L]	150 or less		○
Reference item	Ionic state silica (SiO ₂)	[mg/L]	50 or less		○
	Iron (Fe)	[mg/L]	1.0 or less	○	○
	Copper (Cu)	[mg/L]	0.3 or less	○	
	Sulfide ion (S ₂ ⁻)	[mg/L]	Should not be detected.	○	
	Ammonium ion (NH ₄ ⁺)	[mg/L]	1.0 or less	○	
	Residual chlorine (Cl)	[mg/L]	0.3 or less	○	
	Free carbon (CO ₂)	[mg/L]	4.0 or less	○	

- *1 In the case of [MΩ·cm], it will be 0.001 to 0.01.
 ○: Factors that have an effect on corrosion or scale generation.
 • Even if the water quality standards are met, complete prevention of corrosion is not guaranteed.

3. Set the supply pressure between 0.3 to 0.7 MPa. Ensure a pressure difference at the facility water inlet/outlet of 0.3 MPa or more.

If the supply pressure is high, it will cause water leakage. If the supply pressure and pressure difference at the facility water inlet/outlet is low, it will cause an insufficient flow rate of the facility water, and poor temperature control.

Transportation / Carriage / Movement

Warning

1. Transporting with forklift

1. It is not possible to hang this product.
2. The fork insertion position is either on the left side face or right side face of the unit. Be careful not to bump the fork against a caster or level foot and be sure to put through the fork to the opposite side.
3. Be careful not to bump the fork to the cover panel or piping ports.

2. Transporting with casters

1. This product is heavy and should be moved by at least two people.
2. Do not grip the pipings on the rear side or the handles of the panel.

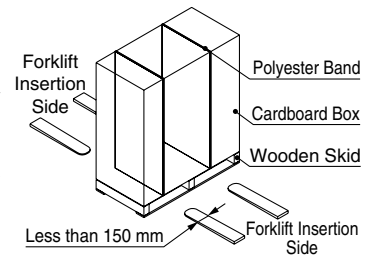

<When Packaged>

Model	Weigh [kg]	Dimensions [mm] (Width x Depth x Height)
HRZ002-W□S-F	195	550 x 1100 x 1265
HRZ004-W□S-F		
HRZ008-W□S-F		
HRZ010-W□S-F		
HRZ008-L□-F	276	550 x 1310 x 1395

Mounting / Installation

Caution

1. Avoid using this product outdoors.
2. Install on a rigid floor which can withstand this product's weight.
3. Install a suitable anchor bolt for the anti-quake bracket taking into consideration the user's floor material.
4. Avoid placing heavy objects on this product.



HRZ-F Series

Specific Product Precautions 2-1

Be sure to read this before handling the products. For safety instructions and temperature control equipment precautions, refer to the “Handling Precautions for SMC Products” and the “Operation Manual” on the SMC website: <https://www.smcworld.com>

Piping

Caution

- 1. The circulating fluid and facility water piping should be prepared by user with consideration of the operating pressure, temperature, and circulating fluid/facility compatibility.**

If the operating performance is not sufficient, the pipings may burst during operation. Also, the use of corrosive materials such as aluminum or iron for fluid contact parts, such as piping, may not only lead to clogging or leakage in the circulating fluid and facility water circuits but also refrigerant leakage and other unexpected problems. Provide protection against corrosion when you use the product.

- 2. The surface of the circulating fluid pipings should be covered with the insulating materials which can effectively confine the heat.**

Absorbing the heat from the surface of pipings may reduce the cooling capacity performance and the heating capacity may be shortened due to heat radiation.

- 3. When using fluorinated liquid as the circulating fluid, do not use pipe tape.**

Liquid leakage may occur around the pipe tape.
For sealant, we recommend that you use the following sealant: SMC Part No., HRZ-S0003 (Silicone sealant)

- 4. For the circulating fluid pipings, use clean pipings which have no dust, oil or water moisture inside the pipings, and blow with air prior to undertaking any piping works.**

If any dust, oil or water moisture enters the circulating fluid circuit, inferior cooling performance or equipment failure due to frozen water may occur, resulting in bubbles in the circulating fluid inside the tank.

- 5. The reciprocating total volume of the circulating fluid pipings must be less than the volume of the sub-tank.**

Otherwise, when the equipment is stopped, the in-built alarm may activate or the circulating fluid may leak from the tank. Refer to the specifications table for the sub-tank volume.

- 6. Select the circulating fluid pipings which can exceed the required rated flow.**

For the rated flow, refer to the pump capacity table.

- 7. For the circulating fluid piping connection, install a drain pan just in case the circulating fluid may leak.**

- 8. Do not return the circulating fluid to the unit by installing a pump in the user's system.**

- 9. The facility water flow rate is adjusted automatically according to the operating conditions. In addition, the facility water return temperature is 60°C at maximum.**



HRZ-F Series Specific Product Precautions 3

Be sure to read this before handling the products. For safety instructions and temperature control equipment precautions, refer to the “Handling Precautions for SMC Products” and the “Operation Manual” on the SMC website: <https://www.smcworld.com>

Electrical Wiring

⚠ Caution

1. Power supply and signal cable should be prepared by user.

2. Provide a stable power supply which is not affected by surge or distortion.

If the voltage increase ratio (dV/dt) at the zero cross should exceed 40 V/200 μsec., it may result in a malfunction.

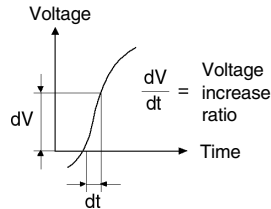

3. This product is installed with a breaker with the following operating characteristics.

For the user's equipment (inlet side), use a breaker whose operating time is equal to or longer than the breaker of this product. If a breaker with shorter operating time is connected, the user's equipment could be cut off due to the inrush current of the motor of this product.

Breaker Operating Characteristics

Applicable model

HRZ002-WS-F
HRZ002-W1S-F
HRZ002-W2S-F
HRZ004-WS-F
HRZ004-W1S-F
HRZ004-W2S-F
HRZ008-WS-F
HRZ008-W1S-F
HRZ008-W2S-F

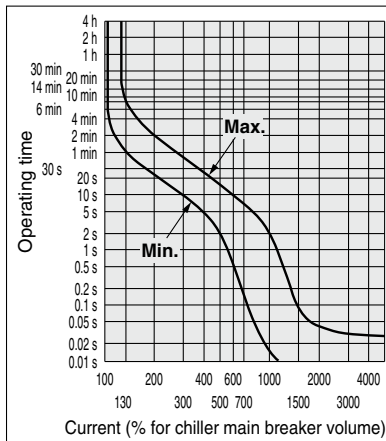

HRZ008-L-F
HRZ008-L1-F
HRZ010-WS-F
HRZ010-W1S-F
HRZ010-W2S-F

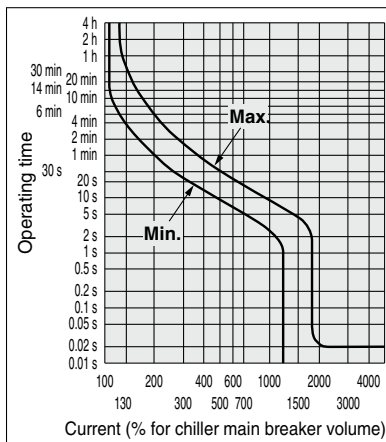

Operation

⚠ Caution

1. Confirmation before operation

1. The circulating fluid should be within the specified range of “HIGH” and “LOW.”
2. Be sure to tighten the cap for the circulating fluid port until the click sound is heard.

2. Emergency stop method

In the case of an emergency, press down the EMO switch which is fitted on the front face of this product.

Operation Restart Time / Operation and Suspension Frequency

⚠ Caution

1. Wait five minutes or more before restarting operation after it has been stopped. If the operation is restarted within five minutes, the protection circuit may activate and the operation may not start properly.

2. Operation and suspension frequency should not exceed 10 times per day. Frequently switching between operation and suspension may result in the malfunction of the refrigeration circuit.

Maintenance

⚠ Warning

1. Do not operate the switch with wet hands or touch electrical parts such as an electrical plug. This will lead to an electrical shock.
2. Do not splash water directly on this product for cleaning. This will lead to an electrical shock or a fire.
3. When the panel was removed for the purpose of inspection or cleaning, mount the panel after works were done.

If the panel is still open, or running the equipment with the panel removed, it may cause an injury or electric shock.

⚠ Caution

1. In order to prevent a sudden product failure of the unit, replace the replacement parts every 36 months.
2. Perform an inspection of the circulating fluid every 3 months.

1. In the case of fluorinated fluids:
Discharge the circulating liquid and avoid any dirty objects, or water moisture, or foreign matter entering the system.
2. In the case of ethylene glycol aqueous solution:
Maintain the condensation at 60%.
3. In the case of tap water/deionized water:
Replacement is recommended.

3. Check the water quality of cooling water every 3 months. Regarding the water quality standards for cooling water, refer to “Temperature Control Equipment Precautions.”



HRZ-F Series

Specific Product Precautions 4

Be sure to read this before handling the products. For safety instructions and temperature control equipment precautions, refer to the “Handling Precautions for SMC Products” and the “Operation Manual” on the SMC website: <https://www.smcworld.com>

■ Refrigerant with GWP reference

Refrigerant	Global Warming Potential (GWP)		
	Regulation (EU) 2024/573, AIM Act 40 CFR Part 84	Fluorocarbon Emissions Control Act (Japan) GWP value labeled on products	GWP value to be used for reporting the calculated amount of leakage
R134a	1,430	1,430	1,300
R404A	3,922	3,920	3,940
R407C	1,774	1,770	1,620
R410A	2,088	2,090	1,920
R448A	1,386	1,390	1,270
R454C	146	145	146

* This product is hermetically sealed and contains fluorinated greenhouse gases (HFC). When this product is sold on the market in the EU after January 1, 2017, it needs to be compliant with the quota system of the F-Gas Regulation in the EU.

* See specification table for refrigerant used in the product.