

# Circulating Fluid Temperature Controller Thermo-chiller Basic Type

## HRSE Series

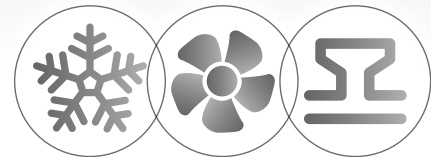

### Efficient energy saving due to the triple control!



Compressor Fan Valve

Triple control



Compressor ON/OFF



Air-cooled condenser fan



Electronic valve control

Power consumption  
reduced by

# 33%

(Energy saving)

\* Under the conditions shown  
on the next page

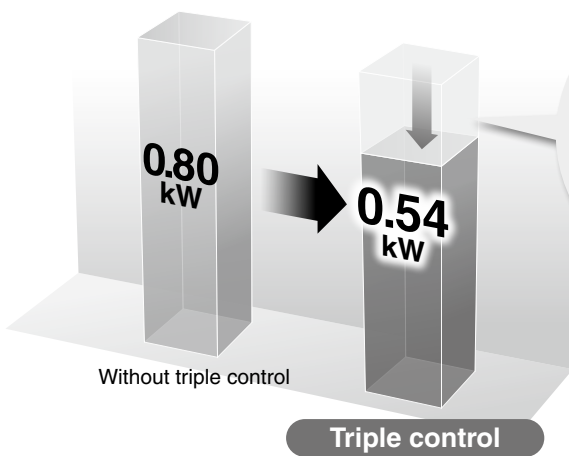

Cooling capacity **1.2, 1.6, 2.2 kW**

Max. ambient temperature **40°C** (200 VAC)

Set temperature range **10 to 30°C**

Temperature stability **±2.0°C**

Maintenance-free **Magnet pump**

Low-noise design **55 dB (A)**

Power supply **100/200 VAC** 50/60 Hz  
**230 VAC** 50/60 Hz

Compact/Lightweight **32 kg** (100 VAC)



# Simple function and performance

Cooling capacity **1.2, 1.6, 2.2 kW (60 Hz)**

Power supply **100/200 VAC (50/60 Hz)**  
**230 VAC (50/60 Hz)**

## Triple control

Compressor, fan and electronic control valve can be controlled depending on the heat load from the user's equipment.

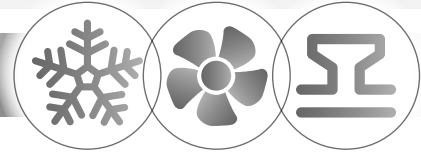

Compressor Fan Valve

**Triple control**

Power consumption

reduced by **33%**

Conditions

• 100 VAC • Frequency: 60 Hz • Circulating fluid temperature in the rated operation: 20°C • Ambient temperature: 25°C • Load: 1200 W • Flow rate: 7 L/min

### Circuit diagram

\* This circuit construction of the position of the parts may be different from actual product.

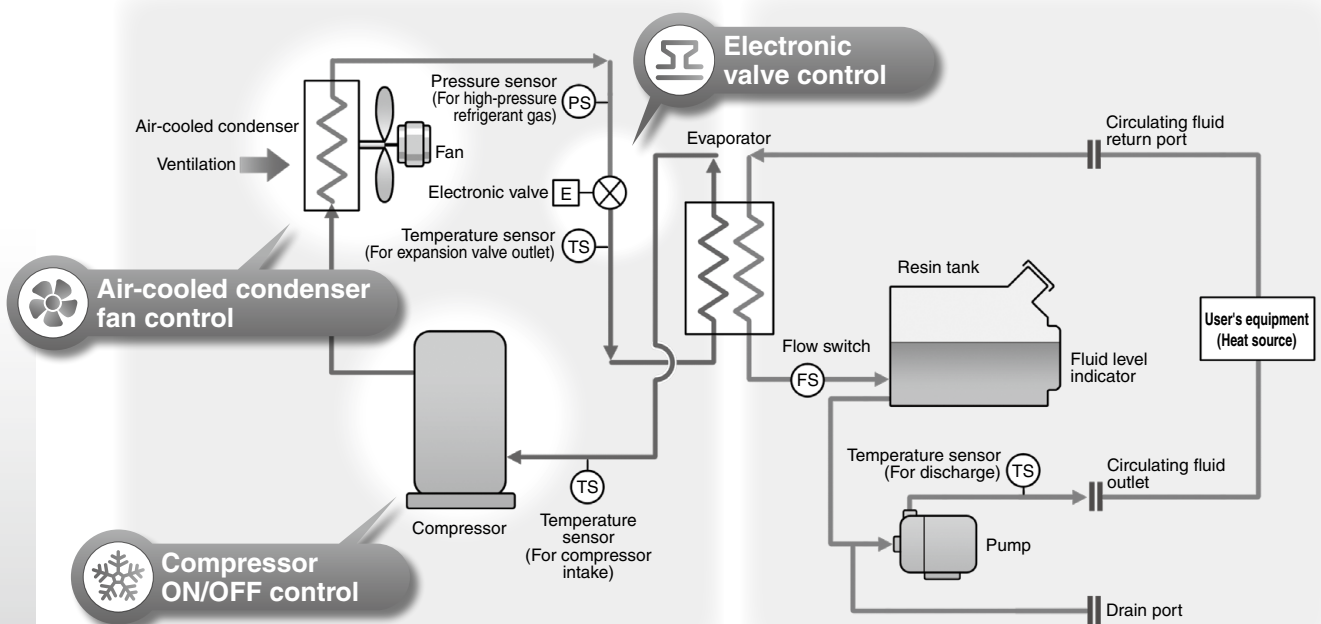

### Refrigeration circuit

- The compressor compresses the refrigerant gas and discharges high-temperature, high-pressure refrigerant gas.
- The high-temperature, high-pressure refrigerant gas is cooled down by fan ventilation in the air-cooled condenser, where it is then liquefied.
- The liquefied high-pressure refrigerant gas expands and its temperature lowers when it passes through the electronic valve, where it vaporizes after receiving heat from the circulating fluid in the evaporator.
- The vaporized refrigerant gas is sucked into the compressor and compressed again.

**Point** Refrigeration circuit control system requires the minimum basic essential function.

According to the amount of heat generated from user's equipment, the system turns power ON/OFF to the compressor and controls the electronic valve. By combining the above function, the system also controls the number of rotations of the fan that is appropriate to the amount of heat and ambient temperature, to provide the performance of temperature control of  $\pm 2^\circ\text{C}$ .

### Circulating fluid circuit

- After the circulating fluid discharged from the pump is heated by the user's equipment, it returns to the tank.
- The circulating fluid is sent to the evaporator by the pump, and is controlled to remain at a set temperature by the refrigeration circuit. It will then be discharged to the user's equipment side again by the thermo-chiller.

**Point** Temperature control system requires the minimum basic essential function.

Signal of temperature sensor for pump discharging controls the refrigeration circuit. Circulating fluid is heated by the pump heat and the amount of heat generated from user's equipment.

# Thermo-chiller of the basic type



## Simple operation

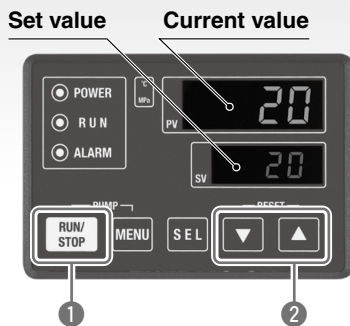

- Step 1**  
Press the **RUM/STOP** key.
- Step 2**  
Adjust the temperature setting with the **▼ / ▲** keys.

## Immediate usage after fitting plug to power supply

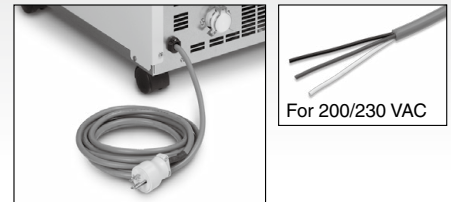

Power cable with plug  
(For 100 VAC)

## Shaped for easy supply of circulating fluid

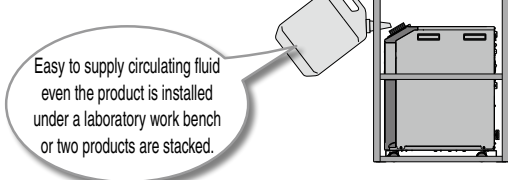

## Easy to check the circulating fluid level

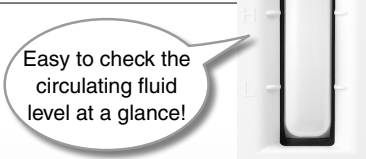

## No tools are required to mount/remove the front panel.

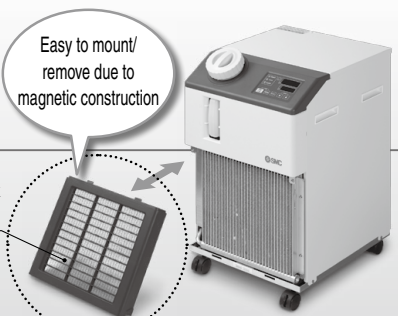

Easy to remove dust, cutting chips, etc., stuck to the dustproof net with a brush or air blow



With casters (Removable)

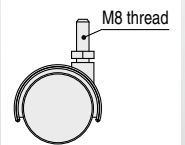

### Option

**High-pressure pump mounted**  
For large piping resistance

**Bypass piping set**  
When the circulating fluid goes below the rated flow (7 L/min), cooling capacity will be reduced or the temperature stability will be badly affected. In such a case, use the bypass piping set.

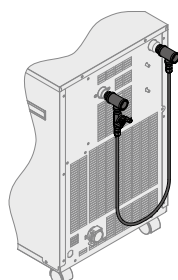

### Optional Accessories

**Replacement type dustproof filter set**  
Suitable for use in excessively dusty atmospheres  
The disposable type filter reduces the time and effort required for cleaning.

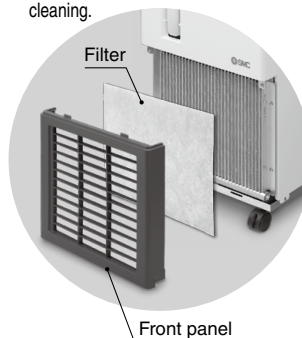

**Particle filter set**  
Removes foreign matter in the circulating fluid

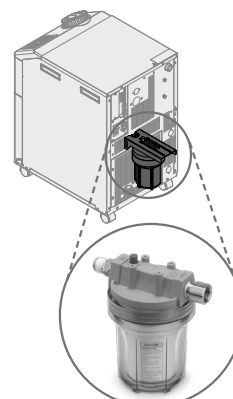

**Anti-quake bracket**  
Measures against earthquake. It can be fixed to the floor or base.

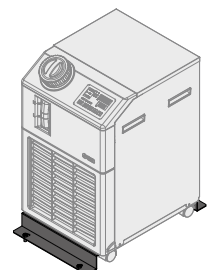

# CONTENTS

## HRSE Series **Basic Type**



### Thermo-chiller HRSE Series

#### How to Order/Specifications

<b>Single-phase 100 VAC</b> .....	Page 212
<b>Single-phase 200 VAC</b> .....	Page 213
<b>Single-phase 230 VAC</b> .....	Page 214
Cooling Capacity .....	Page 215
Pump Capacity .....	Page 216
Dimensions .....	Page 217
Operation Display Panel .....	Page 218
Alarm .....	Page 218

#### ● **Option**

High-Pressure Pump Mounted .....	Page 219
----------------------------------	----------

#### ● **Optional Accessories**

① Anti-quake Bracket .....	Page 220
② Bypass Piping Set .....	Page 220
③ Replacement Type Dustproof Filter Set .....	Page 221
④ Particle Filter Set .....	Page 221

#### ● **Cooling Capacity Calculation**

Required Cooling Capacity Calculation .....	Page 222
Precautions on Cooling Capacity Calculation .....	Page 223
Circulating Fluid Typical Physical Property Values .....	Page 223

Specific Product Precautions .....	Page 224
------------------------------------	----------

# Thermo-chiller **Basic Type**

## Single-phase 100 VAC

### HRSE Series

RoHS



#### How to Order

HRSE **018** - **A** - **10** -   

#### Cooling capacity

<b>012</b>	Cooling capacity 1000/1200 W (50/60 Hz)
<b>018</b>	Cooling capacity 1400/1600 W (50/60 Hz)

#### Cooling method

<b>A</b>	Air-cooled refrigeration
----------	--------------------------

#### Option

Symbol	Option
<b>Nil</b>	None
<b>T</b>	High-pressure pump mounted*1

\*1 The cooling capacity will decrease by about 100 W from the value in the catalog. The performance is different between product models. Make sure to check the pump capacity before selecting models.

#### Power supply

Symbol	Power supply
<b>10</b>	Single-phase 100 VAC (50/60 Hz)

#### Specifications \* There are different values from standard specifications.

Model		HRSE012-A-10-(T)	HRSE018-A-10-(T)
<b>Cooling method</b>		Air-cooled refrigeration	
<b>Refrigerant</b>		R407C (HFC)	
<b>Refrigerant charge</b>	kg	0.3	0.32
<b>Control method</b>		Compressor ON/OFF	
<b>Ambient temperature/Humidity/Altitude*1, 11</b>		Temperature: 5 to 35°C, Humidity: 30 to 70%, Altitude: less than 3000 m	
<b>Circulating fluid system</b>	<b>Circulating fluid*2</b>	Tap water, 15% ethylene glycol aqueous solution	
	<b>Set temperature range*1</b>	°C 10 to 30	
	<b>Cooling capacity*3, 11</b>	1000/1200 For option -T: 900/1100	1400/1600 For option -T: 1300/1500
	<b>Temperature stability*4</b>	°C ±2	
	<b>Pump capacity (50/60 Hz)*5</b>	MPa 0.08 (at 7 L/min)/0.11 (at 7 L/min) For option -T: 0.13 (at 7 L/min)/0.18 (at 7 L/min)	
	<b>Rated flow (50/60 Hz)*6</b>	L/min 7/7	
	<b>Tank capacity</b>	L Approx. 5	
	<b>Port size</b>	Rc1/2	
<b>Fluid contact material</b>		Stainless steel, Copper (Heat exchanger brazing), Bronze, Brass, Ceramic, Carbon, PP, PE, POM, EPDM, PVC	
<b>Electrical system</b>	<b>Power supply</b>	Single-phase 100 VAC 50/60 Hz Allowable voltage range ±10%	
	<b>Fuse</b>	A 15	
	<b>Power cable size*10</b>	— 3 cores x 14 AWG (2.0 mm <sup>2</sup> ), 3 m	
	<b>Applicable earth leakage breaker capacity*7</b>	A 15	
	<b>Rated operating current (50/60 Hz)*3</b>	7.1/7.8 For option -T: 7.8/8.4	7.1/7.8 For option -T: 7.8/8.4
	<b>Rated power consumption (50/60 Hz)*3</b>	0.53/0.54 For option -T: 0.62/0.62	0.63/0.63 For option -T: 0.72/0.72
<b>Dimensions*8</b>	mm	W377 x D435 x H615 For option -T: W377 x D500 x H615	
<b>Accessories</b>		Fitting (for drain outlet) 1 pc., Operation Manual (for installation/operation) 1	
<b>Weight*9</b>	kg	32 For option -T: 39	

- \*1 No condensation should be present. During seasons or in locations where the ambient temperature is likely to fall below freezing point, please contact SMC.
- \*2 If tap water is used, about the water quality SMC recommends, refer to "Specific Product Precautions" for water quality specifications.
- \*3 ① Ambient temperature: 25°C, ② Circulating fluid temperature: 20°C, ③ Circulating fluid at the rated flow, ④ Circulating fluid: Tap water
- \*4 Temperature at the thermo-chiller outlet when the circulating fluid flow is at the rated flow and the circulating fluid outlet and return port are directly connected. The installation environment and power supply are within the specification range and stable.
- \*5 The capacity at the thermo-chiller outlet when the circulating fluid temperature is 20°C
- \*6 The required flow rate for maintaining the cooling capacity or temperature stability. The specification of the cooling capacity and the temperature stability may not be satisfied if the flow rate is lower than the rated flow.
- \*7 Purchase an earth leakage breaker with a sensitivity current of 15 mA or 30 mA/power supply 100 VAC separately.
- \*8 Dimensions between panels, not including the dimensions of protrusion
- \*9 Weight in the dry state without circulating fluids
- \*10 Cable terminal is provided with a plug with ground terminal (JIS C 8303 Plug for the receptacle with dipoles grounding electrode).
- \*11 If the product is used at an altitude of 1000 m or higher, refer to "Operating Environment/Storage Environment" (page 225) Item 14 "For altitudes of 1000 m or higher."

# Thermo-chiller **Basic Type**

## Single-phase 200 VAC

### HRSE Series

RoHS



#### How to Order

HRSE **018** - **A** - **20** -   

#### Cooling capacity

<b>012</b>	Cooling capacity 1000/1200 W (50/60 Hz)
<b>018</b>	Cooling capacity 1400/1600 W (50/60 Hz)
<b>024</b>	Cooling capacity 1900/2200 W (50/60 Hz)

#### Cooling method

<b>A</b>	Air-cooled refrigeration
----------	--------------------------

#### Option

Symbol	Option
<b>Nil</b>	None
<b>T</b>	High-pressure pump mounted*1

\*1 The cooling capacity will decrease by about 100 W from the value in the catalog. The performance is different between product models. Make sure to check the pump capacity before selecting models.

#### Power supply

Symbol	Power supply
<b>20</b>	Single-phase 200 VAC (50/60 Hz)

#### Specifications \* There are different values from standard specifications.

Model		HRSE012-A-20-(T)	HRSE018-A-20-(T)	HRSE024-A-20-(T)
<b>Cooling method</b>		Air-cooled refrigeration		
<b>Refrigerant</b>		R407C (HFC)		
<b>Refrigerant charge</b>	kg	0.32	0.33	0.34
<b>Control method</b>		Compressor ON/OFF		
<b>Ambient temperature/Humidity/Altitude</b> *1, 11		Temperature: 5 to 40°C, Humidity: 30 to 70%, Altitude: less than 3000 m		
<b>Circulating fluid system</b>	<b>Circulating fluid</b> *2	Tap water, 15% ethylene glycol aqueous solution		
	<b>Set temperature range</b> *1	°C 10 to 30		
	<b>Cooling capacity (50/60 Hz)</b> *3, 11	W 1000/1200 For option -T: 900/1100	1400/1600 For option -T: 1300/1500	1900/2200 For option -T: 1800/2100
	<b>Temperature stability</b> *4	°C ±2		
	<b>Pump capacity (50/60 Hz)</b> *5	MPa 0.08 (at 7 L/min)/0.11 (at 7 L/min) For option -T: 0.13 (at 7 L/min)/0.18 (at 7 L/min)		
	<b>Rated flow (50/60 Hz)</b> *6	L/min 7/7		
	<b>Tank capacity</b>	L Approx. 5		
	<b>Port size</b>	Rc1/2		
<b>Fluid contact material</b>		Stainless steel, Copper (Heat exchanger brazing), Bronze, Brass, Ceramic, Carbon, PP, PE, POM, EPDM, PVC		
<b>Electrical system</b>	<b>Power supply</b>	Single-phase 200 VAC 50/60 Hz Allowable voltage range ±10%		
	<b>Fuse</b>	A 15		
	<b>Power cable size</b> *10	— 3 cores x 14 AWG (2.0 mm <sup>2</sup> ), 3 m		
	<b>Applicable earth leakage breaker capacity</b> *7	A 15		
	<b>Rated operating current (50/60 Hz)</b> *3	A 4.1/5.0 For option -T: 4.5/5.4	4.2/5.3 For option -T: 4.6/5.7	4.3/5.4 For option -T: 4.7/5.8
<b>Rated power consumption (50/60 Hz)</b> *3	kVA 0.58/0.74 For option -T: 0.66/0.82	0.73/0.86 For option -T: 0.81/0.94	0.85/1.02 For option -T: 0.93/1.10	
<b>Dimensions</b> *8	mm	W377 x D435 x H615 For option -T: W377 x D500 x H615		
<b>Accessories</b>		Fitting (for drain outlet) 1 pc., Operation Manual (for installation/operation) 1		
<b>Weight</b> *9	kg	35 For option -T: 42		

\*1 No condensation should be present. During seasons or in locations where the ambient temperature is likely to fall below freezing point, please contact SMC.

\*2 If tap water is used, about the water quality SMC recommends, refer to "Specific Product Precautions" for water quality specifications.

\*3 ① Ambient temperature: 25°C, ② Circulating fluid temperature: 20°C, ③ Circulating fluid at the rated flow, ④ Circulating fluid: Tap water

\*4 Temperature at the thermo-chiller outlet when the circulating fluid flow is at the rated flow and the circulating fluid outlet and return port are directly connected  
The installation environment and power supply are within the specification range and stable.

\*5 The capacity at the thermo-chiller outlet when the circulating fluid temperature is 20°C

\*6 The required flow rate for maintaining the cooling capacity or temperature stability may not be satisfied if the flow rate is lower than the rated flow.

\*7 Purchase an earth leakage breaker with a sensitivity current of 30 mA/ power supply 200 VAC separately.

\*8 Dimensions between panels, not including the dimensions of protrusion

\*9 Weight in the dry state without circulating fluids

\*10 The end parts of all three lead wires of the cable terminal are untreated (bare cut).  
\*11 If the product is used at an altitude of 1000 m or higher, refer to "Operating Environment/Storage Environment" (page 225) Item 14 "For altitudes of 1000 m or higher."

# Thermo-chiller Basic Type Single-phase 230 VAC

## HRSE Series



### How to Order

**HRSE 018 - A - 23 -**

#### Cooling capacity

<b>012</b>	Cooling capacity 1000/1200 W (50/60 Hz)
<b>018</b>	Cooling capacity 1400/1600 W (50/60 Hz)
<b>024</b>	Cooling capacity 1900/2200 W (50/60 Hz)

#### Cooling method

<b>A</b>	Air-cooled refrigeration
----------	--------------------------

#### Option

Symbol	Option
<b>Nil</b>	None
<b>T</b>	High-pressure pump mounted*1

\*1 The cooling capacity will decrease by about 100 W from the value in the catalog. The performance is different between product models. Make sure to check the pump capacity before selecting models.

#### Power supply

Symbol	Power supply
<b>23</b>	Single-phase 230 VAC (50/60 Hz)

### Specifications \* There are different values from standard specifications.

Model		HRSE012-A-23-(T)	HRSE018-A-23-(T)	HRSE024-A-23-(T)
<b>Cooling method</b>		Air-cooled refrigeration		
<b>Refrigerant</b>		R407C (HFC)		
<b>Refrigerant charge</b>	kg	0.32	0.33	0.34
<b>Control method</b>		Compressor ON/OFF		
<b>Ambient temperature/Humidity/Altitude</b> *1, 11		Temperature: 5 to 40°C, Humidity: 30 to 70%, Altitude: less than 3000 m		
<b>Circulating fluid system</b>	<b>Circulating fluid</b> *2	Tap water, 15% ethylene glycol aqueous solution		
	<b>Set temperature range</b> *1	°C 10 to 30		
	<b>Cooling capacity (50/60 Hz)</b> *3, 11	W 1000/1200 For option -T: 900/1100	1400/1600 For option -T: 1300/1500	1900/2200 For option -T: 1800/2100
	<b>Temperature stability</b> *4	°C ±2		
	<b>Pump capacity (50/60 Hz)</b> *5	MPa 0.08 (at 7 L/min)/0.11 (at 7 L/min) For option -T: 0.13 (at 7 L/min)/0.18 (at 7 L/min)		
	<b>Rated flow (50/60 Hz)</b> *6	L/min 7/7		
	<b>Tank capacity</b>	L Approx. 5		
	<b>Port size</b>	Rc1/2		
<b>Fluid contact material</b>		Stainless steel, Copper (Heat exchanger brazing), Bronze, Brass, Ceramic, Carbon, PP, PE, POM, EPDM, PVC		
<b>Electrical system</b>	<b>Power supply</b>	Single-phase 230 VAC 50/60 Hz Allowable voltage range ±10%		
	<b>Fuse</b>	A 15		
	<b>Power cable size</b> *10	— 3 cores x 14 AWG (2.0 mm <sup>2</sup> ), 3 m		
	<b>Applicable earth leakage breaker capacity</b> *7	A 15		
	<b>Rated operating current (50/60 Hz)</b> *3	A 4.1/5.0 For option -T: 4.5/5.4	4.2/5.3 For option -T: 4.6/5.7	4.3/5.4 For option -T: 4.7/5.8
	<b>Rated power consumption (50/60 Hz)</b> *3	kVA 0.58/0.74 For option -T: 0.66/0.82	0.73/0.86 For option -T: 0.81/0.94	0.87/1.04 For option -T: 0.93/1.10
<b>Dimensions</b> *8	mm	W377 x D435 x H615 For option -T: W377 x D500 x H615		
<b>Accessories</b>		Fitting (for drain outlet) 1 pc., Operation Manual (for installation/operation) 1		
<b>Weight</b> *9	kg	35 For option -T: 42		

\*1 No condensation should be present. During seasons or in locations where the ambient temperature is likely to fall below freezing point, please contact SMC.

\*2 If tap water is used, about the water quality SMC recommends, refer to "Specific Product Precautions" for water quality specifications.

\*3 ① Ambient temperature: 25°C, ② Circulating fluid temperature: 20°C, ③ Circulating fluid at the rated flow, ④ Circulating fluid: Tap water

\*4 Temperature at the thermo-chiller outlet when the circulating fluid flow is at the rated flow and the circulating fluid outlet and return port are directly connected  
The installation environment and power supply are within the specification range and stable.

\*5 The capacity at the thermo-chiller outlet when the circulating fluid temperature is 20°C

\*6 The required flow rate for maintaining the cooling capacity or temperature stability  
The specification of the cooling capacity and the temperature stability may not be satisfied if the flow rate is lower than the rated flow.

\*7 Purchase an earth leakage breaker with a sensitivity current of 30 mA/ power supply 230 VAC separately.

\*8 Dimensions between panels, not including the dimensions of protrusion

\*9 Weight in the dry state without circulating fluids

\*10 The end parts of all three lead wires of the cable terminal are untreated (bare cut).

\*11 If the product is used at an altitude of 1000 m or higher, refer to "Operating Environment/Storage Environment" (page 225) Item 14 "For altitudes of 1000 m or higher."

# HRSE Series Basic Type

\* If the product is used at an altitude of 1000 m or higher, refer to "Operating Environment/Storage Environment" (page 225) Item 14 "For altitudes of 1000 m or higher."

\* For models with a high-pressure pump mounted (-T), the cooling capacity will decrease by about 100 W from each graph.

## Cooling Capacity

**HRSE012-A-10(-T)**

[50 Hz]

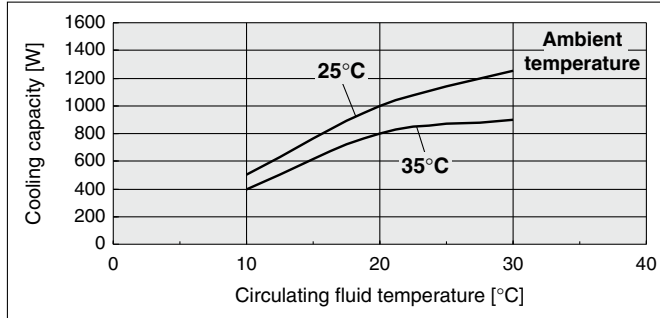

[60 Hz]

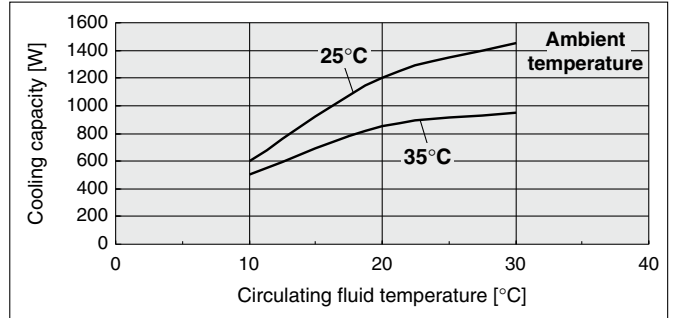

**HRSE018-A-10(-T)**

[50 Hz]

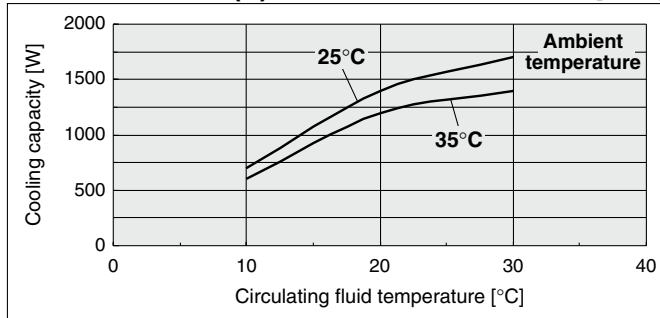

[60 Hz]

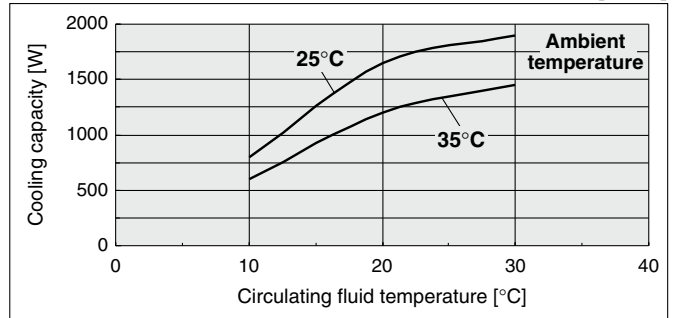

**HRSE012-A-20/23(-T)**

[50 Hz]

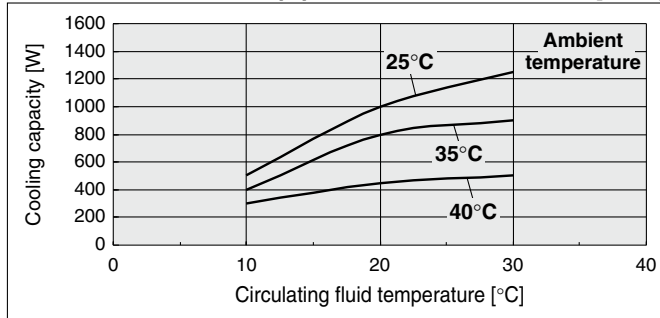

[60 Hz]

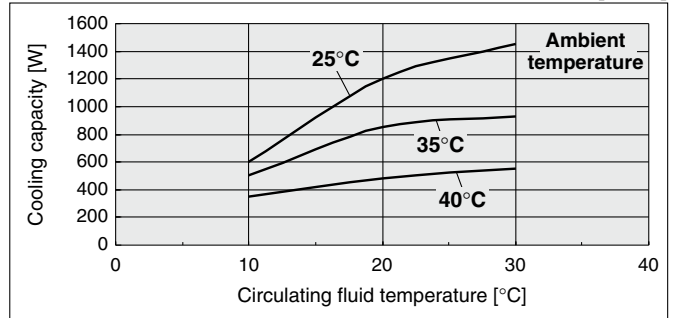

**HRSE018-A-20/23(-T)**

[50 Hz]

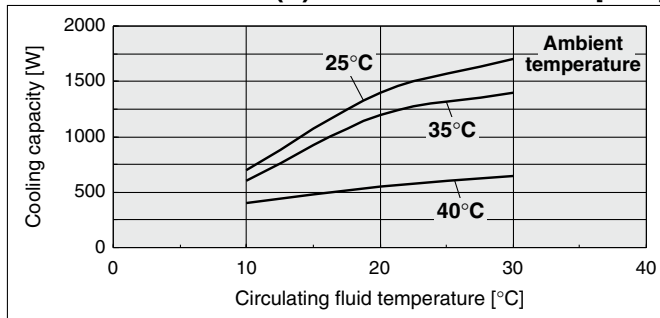

[60 Hz]

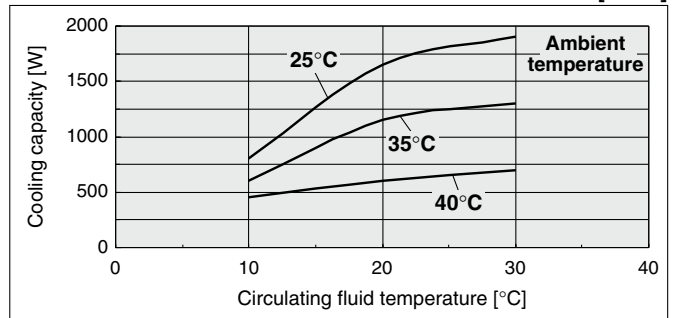

**HRSE024-A-20/23(-T)**

[50 Hz]

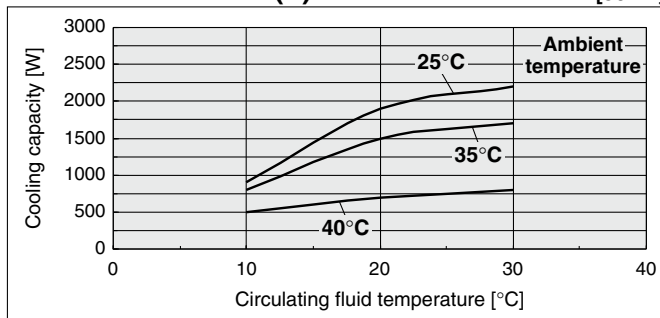

[60 Hz]

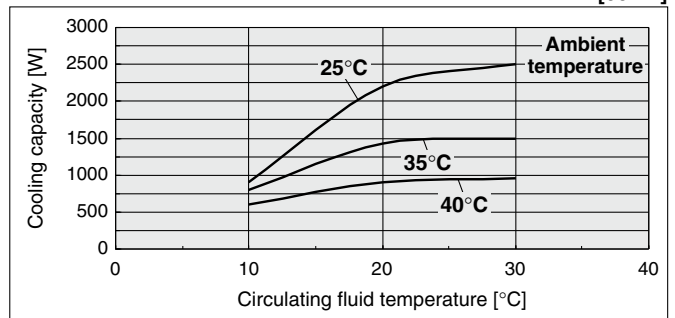



**Pump Capacity**

**HRSE<sup>012</sup><sub>018</sub>-A-10**

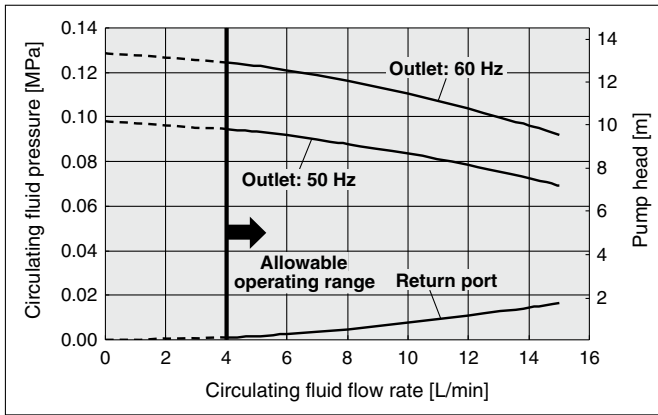

**HRSE<sup>012</sup><sub>018</sub>-A-20/23**  
**024**

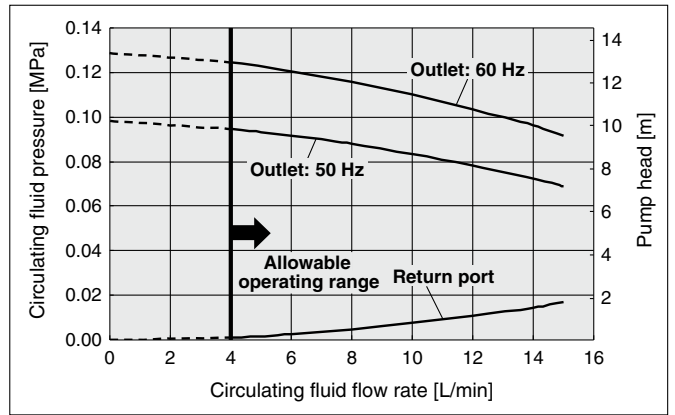

**Option (-T): High-Pressure Pump Mounted**

**HRSE<sup>012</sup><sub>018</sub>-A-10-T**

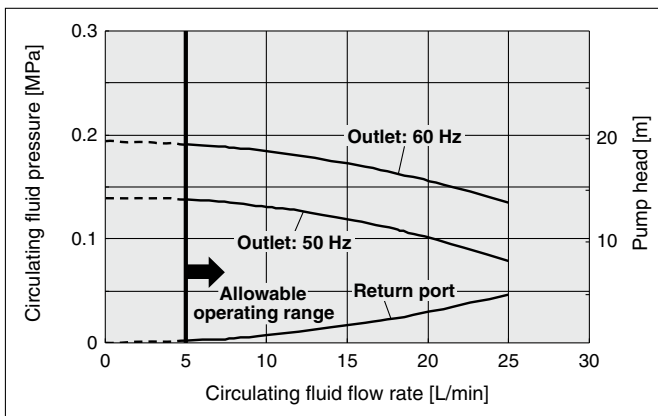

**Option (-T): High-Pressure Pump Mounted**

**HRSE<sup>012</sup><sub>018</sub>-A-20/23-T**  
**024**

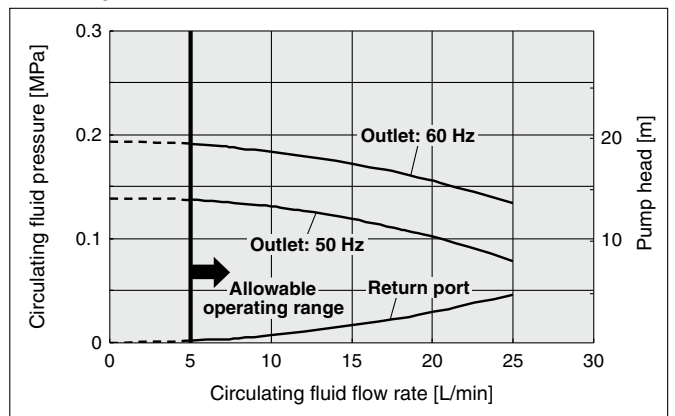

## Dimensions

### HRSE012/018/024-A-10/20/23

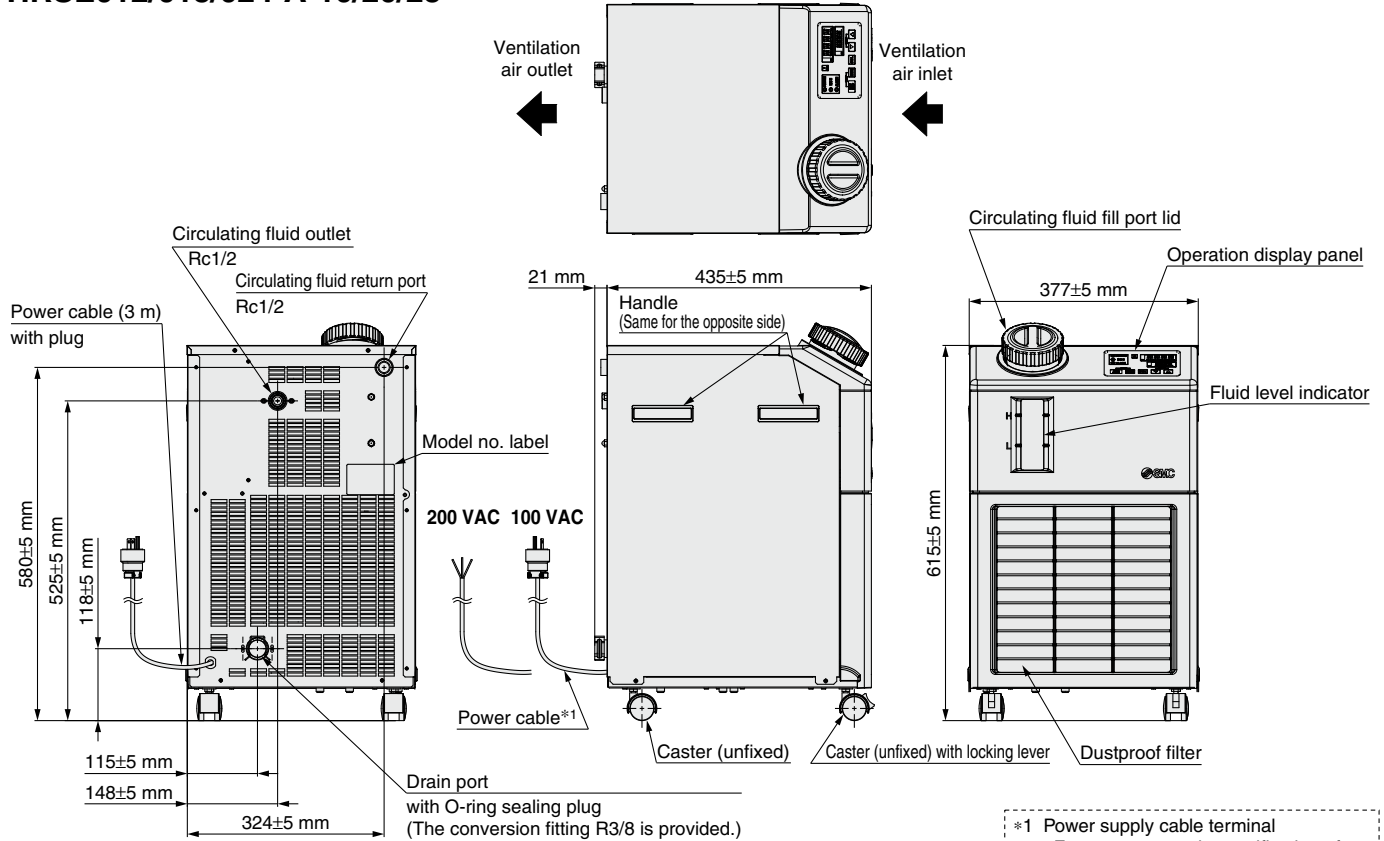

\*1 Power supply cable terminal

- For a power supply specification of 100 V (HRSE□□□-A-10), a plug with ground terminal (JIS C 8303 Plug for the receptacle with dipoles grounding electrode) is included.
- For a power supply specification of 200/230 V (HRSE□□□-A-20/23), the end parts of all three lead wires are untreated (bare cut).

(Blue) End parts are untreated.

(Brown) End parts are untreated.

(Green/Yellow) Grounding cable

Approx. 100 mm

### HRSE012/018/024-A-10/20/23-T (High-pressure pump mounted)

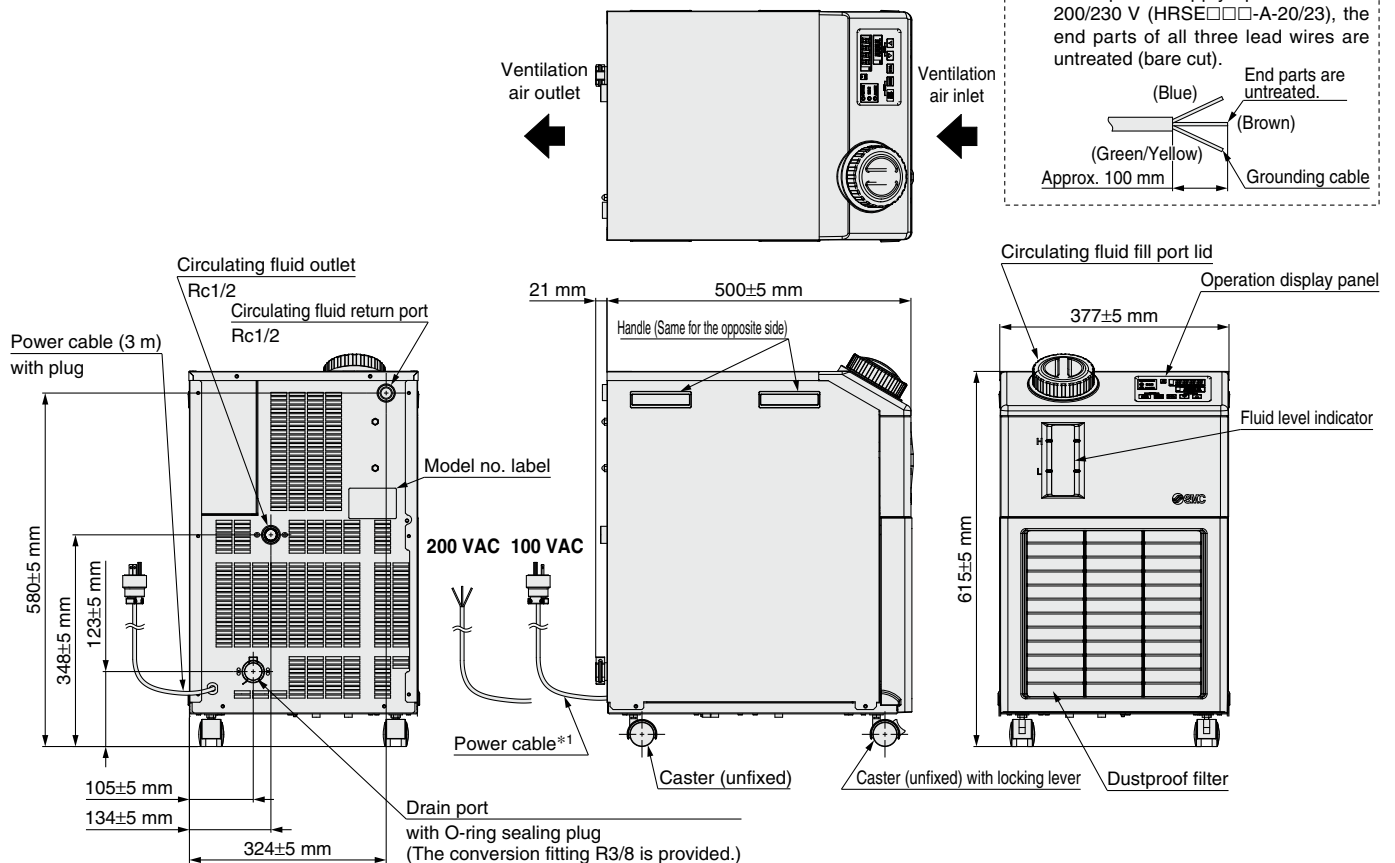

## ● Operation Display Panel

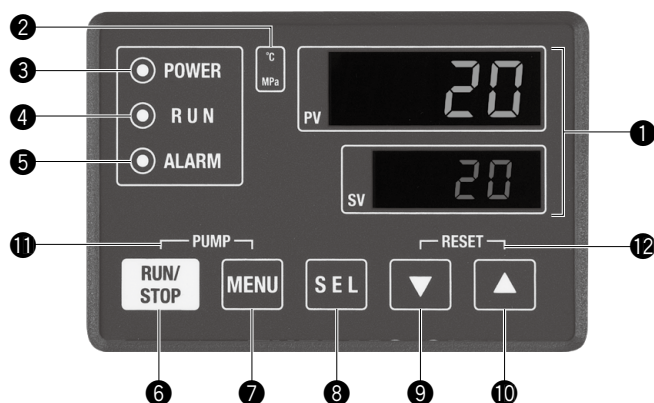

No.	Description	Function
①	<b>Digital display (7 segment, 4 digits)</b>	PV Displays the current circulating fluid temperature, pressure, alarm codes and other menu items (codes). SV Displays the set values of the circulating fluid discharge temperature and other menus.
②	<b>[°C] [MPa] lamp</b>	[°C] lamp is turned on when temperature is displayed on the digital display. [MPa] lamp is turned on when pressure is displayed on the digital display.
③	<b>[POWER] lamp</b>	Lights up when the power is being supplied to the unit.
④	<b>[RUN] lamp</b>	Lights up during operation, and goes off when it is stopped. Flashes during stand-by for stop or independent operation of the pump.
⑤	<b>[ALARM] lamp</b>	Flashes with buzzer when alarm occurs.
⑥	<b>[RUN/STOP] key</b>	Makes the product run or stop.
⑦	<b>[MENU] key</b>	Shifts the main menu (display screen of circulating fluid discharge temperature and pressure, etc.) and other menus (for monitoring and entry of set values).
⑧	<b>[SEL] key</b>	Changes the item in menu and enters the set value.
⑨	<b>[▼] key</b>	Decreases the set value.
⑩	<b>[▲] key</b>	Increases the set value.
⑪	<b>[PUMP] key</b>	Press the [MENU] and [RUN/STOP] keys simultaneously. The pump starts running independently to make the product ready for start-up (release the air).
⑫	<b>[RESET] key</b>	Press the [▼] and [▲] keys simultaneously. The alarm buzzer is stopped and the [ALARM] lamp is reset.

## ● Alarm

Code	Alarm message	Operation status
AL02	High circulating fluid discharge temp.	Stop
AL03	Circulating fluid discharge temp. rise	Continue*1
AL04	Circulating fluid discharge temp. drop	Continue*1
AL07	Abnormal pump operation	Stop
AL15	Refrigerant circuit pressure (high pressure side) drop	Stop
AL20	Memory error	Stop
AL22	Circulating fluid discharge temp. sensor failure	Stop
AL24	Compressor intake temp. sensor failure	Stop
AL26	Compressor discharge pressure sensor failure	Stop
AL27	Heat exchanger inlet temp. sensor failure	Stop
AL28	Pump maintenance	Continue
AL29	Fan motor maintenance	Continue
AL30	Compressor maintenance	Continue

\*1 "Stop" or "Continue" are default settings. Users can change them to "Continue" and "Stop." For details, read the Operation Manual.

# HRSE Series Option

\* Options have to be selected when ordering the thermo-chiller. It is not possible to add them after purchasing the unit.

**T** Option symbol

High-Pressure Pump Mounted

HRSE  - A -  - T

• High-pressure pump mounted

Possible to choose a high-pressure pump in accordance with user's piping resistance. Cooling capacity will decrease by heat generated in the pump.

# HRSE Series Optional Accessories

## ① Anti-quake Bracket

Bracket for earthquakes. Anchor bolt (M8) suitable for the flooring material should be prepared separately by user.  
(Anti-quake bracket thickness: 1.6 mm)

Part no. (per unit)	Applicable model	A	B	C	D
<b>HRS-TK003</b>	HRSE012-A-□	240	(335)	505	(540)
	HRSE018-A-□				
	HRSE024-A-□				
	HRSE012-A-□-T	240	(335)	555	(590)
	HRSE018-A-□-T				
	HRSE024-A-□-T				

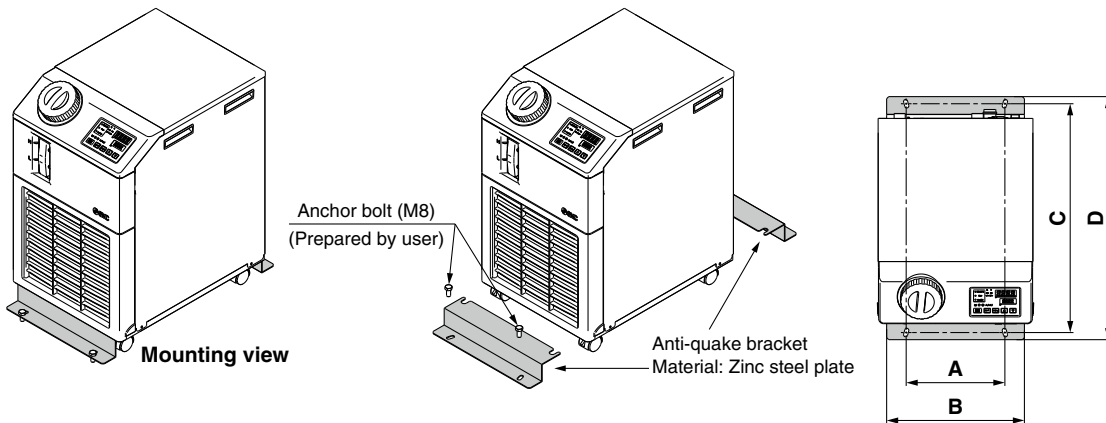

## ② Bypass Piping Set

When the circulating fluid goes below the rated flow (7 L/min), cooling capacity will be reduced and the temperature stability will be badly affected. In such a case, use the bypass piping set.  
A high-pressure pump is also available.

Part no.	Applicable model
<b>HRS-BP001</b>	HRSE012-A-□(-T) HRSE018-A-□(-T) HRSE024-A-□(-T)

### Parts List

No.	Description
①	Bypass tube (700 mm) (Part no.: TL0806)
②	Outlet piping (With ball valve)
③	Return port piping
④	Nipple (Size: 1/2) (2 pcs.)

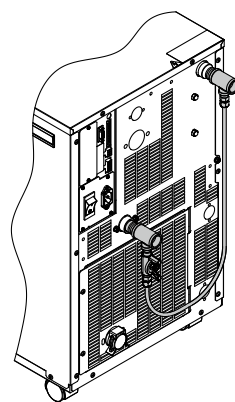

\* To be mounted by user.

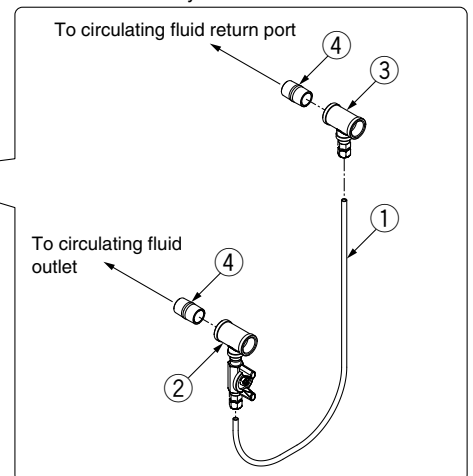

# HRSE Series

## ③ Replacement Type Dustproof Filter Set

A disposable dustproof filter is mounted instead of the dustproof net on the front panel.

Part no.	Applicable model
<b>HRS-FL001</b>	HRSE□-A-□-(T)

### Parts List

No.	Description	Part no.	Note
①	Replacement type dustproof filter set	HRS-FL001	Front panel with hook-and-loop fastener for holding filter 5 filters are included. (No dustproof net is included.)
②	Replacement type dustproof filter	HRS-FL002	5 filters per set Size: 300 x 370

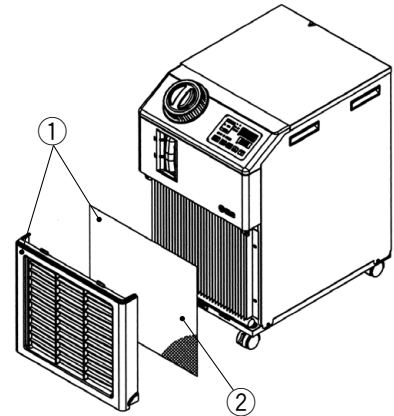

## ④ Particle Filter Set

Removes foreign matter in the circulating fluid.

**HRS-PF001-W075-H**

● Table 2

Symbol	Accessory
<b>Nil</b>	None
<b>H</b>	With handle

● Table 1

Symbol	Nominal filtration accuracy [μm]	Replacement element part no. for L125 (individual part)
<b>Nil</b>	Without element	—
<b>W005</b>	5	EJ202S-005X11
<b>W075</b>	75	EJ202S-075X11

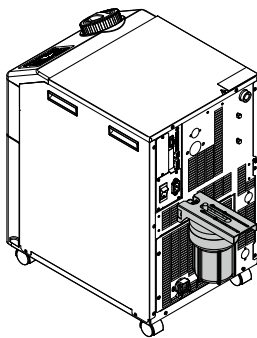

Mounting view

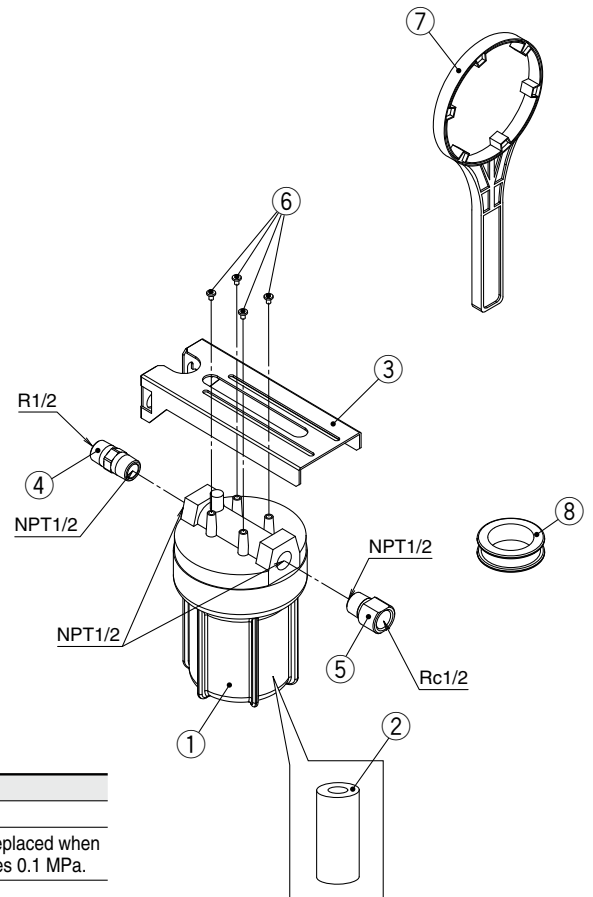
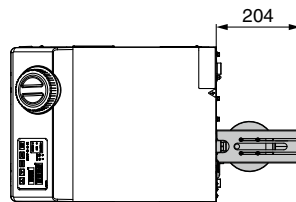

### Parts List

No.	Model	Description	Material	Qty.	Note
①	—	Body	PP	1	—
②	EJ202S-005X11 EJ202S-075X11	Element	PP/PE	1	The product should be replaced when the pressure drop reaches 0.1 MPa.
③	—	Particle filter bracket	SGCC	1	—
④	—	Nipple	Stainless steel	1	Conversion from R to NPT
⑤	—	Extension piece	Stainless steel	1	Conversion from NPT to Rc
⑥	—	Tapping screw	—	4	—
⑦	—	Handle	—	1	When -H is selected
⑧	—	Sealant tape	PTFE	1	—

# Cooling Capacity Calculation

## Required Cooling Capacity Calculation

### Example 1: When the heat generation amount in the user's equipment is known.

The heat generation amount can be determined based on the power consumption or output of the heat generating area — i.e. the area requiring cooling — within the user's equipment.\*1

Q: Heat generation amount

① Derive the heat generation amount from the power consumption.

Power consumption P: 1000 [W]

$$Q = P = 1000 \text{ [W]}$$

Cooling capacity = Considering a safety factor of 20%,

$$1000 \text{ [W]} \times 1.2 = 1200 \text{ [W]}$$

② Derive the heat generation amount from the power supply output.

Power supply output VI: 1.0 [kVA]

$$Q = P = V \times I \times \text{Power factor}$$

In this example, using a power factor of 0.85:

$$= 1.0 \text{ [kVA]} \times 0.85 = 0.85 \text{ [kW]} = 850 \text{ [W]}$$

Cooling capacity = Considering a safety factor of 20%,

$$850 \text{ [W]} \times 1.2 = 1020 \text{ [W]}$$

③ Derive the heat generation amount from the output.

Output (shaft power, etc.) W: 800 [W]

$$Q = P = \frac{W}{\text{Efficiency}}$$

In this example, using an efficiency of 0.7:

$$= \frac{800}{0.7} = 1143 \text{ [W]}$$

Cooling capacity = Considering a safety factor of 20%,

$$1143 \text{ [W]} \times 1.2 = 1372 \text{ [W]}$$

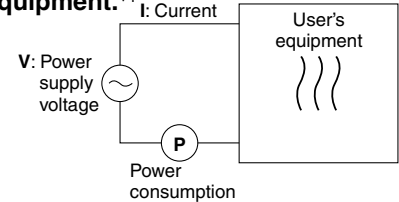

\*1 The examples above calculate the heat generation amount based on the power consumption. The actual heat generation amount may differ due to the structure of the user's equipment. Be sure to check it carefully.

### Example 2: When the heat generation amount in the user's equipment is not known.

Obtain the temperature difference between inlet and outlet by circulating the circulating fluid inside the user's equipment.

- Heat generation amount by user's equipment Q : Unknown [W] ([J/s])
- Circulating fluid : Tap water\*1
- Circulating fluid mass flow rate  $q_m$  : ( $= \rho \times q_v \div 60$ ) [kg/s]
- Circulating fluid density  $\rho$  : 1 [kg/dm<sup>3</sup>]
- Circulating fluid (volume) flow rate  $q_v$  : 10 [dm<sup>3</sup>/min]
- Circulating fluid specific heat C :  $4.2 \times 10^3$  [J/(kg·K)]
- Circulating fluid outlet temperature T<sub>1</sub> : 293 [K] (20 [°C])
- Circulating fluid return temperature T<sub>2</sub> : 295 [K] (22 [°C])
- Circulating fluid temperature difference  $\Delta T$  : 2.0 [K] ( $= T_2 - T_1$ )
- Conversion factor: minutes to seconds (SI units) : 60 [s/min]

\*1 Refer to page 223 for the typical physical property value of tap water or other circulating fluids.

$$Q = q_m \times C \times (T_2 - T_1)$$

$$= \frac{\rho \times q_v \times C \times \Delta T}{60} = \frac{1 \times 10 \times 4.2 \times 10^3 \times 2.0}{60}$$

$$= 1400 \text{ [J/s]} \approx 1400 \text{ [W]}$$

Cooling capacity = Considering a safety factor of 20%,

$$1400 \text{ [W]} \times 1.2 = 1680 \text{ [W]}$$

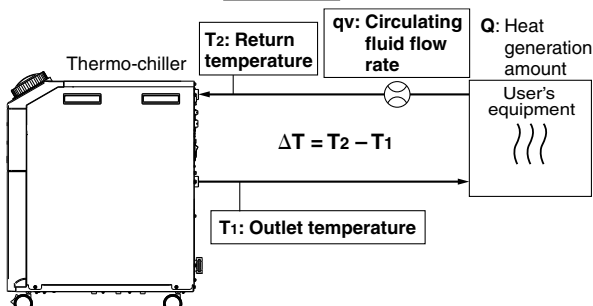

#### Example of conventional units (Reference)

- Heat generation amount by user's equipment Q : Unknown [cal/h] → [W]
- Circulating fluid : Tap water\*1
- Circulating fluid weight flow rate  $q_m$  : ( $= \rho \times q_v \times 60$ ) [kgf/h]
- Circulating fluid weight volume ratio  $\gamma$  : 1 [kgf/L]
- Circulating fluid (volume) flow rate  $q_v$  : 10 [L/min]
- Circulating fluid specific heat C :  $1.0 \times 10^3$  [cal/(kgf·°C)]
- Circulating fluid outlet temperature T<sub>1</sub> : 20 [°C]
- Circulating fluid return temperature T<sub>2</sub> : 22 [°C]
- Circulating fluid temperature difference  $\Delta T$  : 2.0 [°C] ( $= T_2 - T_1$ )
- Conversion factor: hours to minutes : 60 [min/h]
- Conversion factor: kcal/h to kW : 860 [(cal/h)/W]

$$Q = \frac{q_m \times C \times (T_2 - T_1)}{860}$$

$$= \frac{\gamma \times q_v \times 60 \times C \times \Delta T}{860}$$

$$= \frac{1 \times 10 \times 60 \times 1.0 \times 10^3 \times 2.0}{860}$$

$$= \frac{1200000 \text{ [cal/h]}}{860}$$

$$\approx 1400 \text{ [W]}$$

Cooling capacity = Considering a safety factor of 20%,

$$1400 \text{ [W]} \times 1.2 = 1680 \text{ [W]}$$

## Required Cooling Capacity Calculation

### Example 3: When there is no heat generation, and when cooling the object below a certain temperature and period of time.

Heat quantity by cooled substance (per unit time) **Q**: Unknown [W] [(J/s)]  
 Cooled substance : Water  
 Cooled substance mass **m** : (=  $\rho \times V$ ) [kg]  
 Cooled substance density  $\rho$  : 1 [kg/L]  
 Cooled substance total volume **V** : 20 [dm<sup>3</sup>]  
 Cooled substance specific heat **C** : 4.2 x 10<sup>3</sup> [J/(kg·K)]  
 Cooled substance temperature when cooling begins **To**: 305 [K] (32 [°C])  
 Cooled substance temperature after t hour **Tt** : 293 [K] (20 [°C])  
 Cooling temperature difference  $\Delta T$  : 12 [K] (=  $T_0 - T_t$ )  
 Cooling time  $\Delta t$  : 900 [s] (= 15 [min])

\* Refer to the following for the typical physical property values by circulating fluid.

$$Q = \frac{m \times C \times (T_0 - T_t)}{\Delta t} = \frac{\rho \times V \times C \times \Delta T}{\Delta t}$$

$$= \frac{1 \times 20 \times 4.2 \times 10^3 \times 12}{900} = 1120 \text{ [J/s]} \approx 1120 \text{ [W]}$$

Cooling capacity = Considering a safety factor of 20%,

$$1120 \text{ [W]} \times 1.2 = \boxed{1344 \text{ [W]}}$$

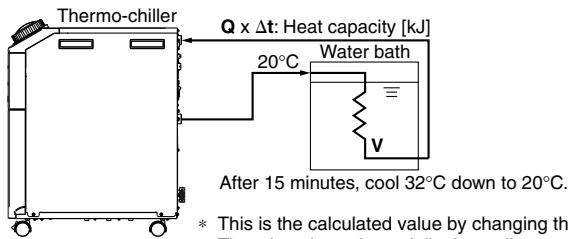

\* This is the calculated value by changing the fluid temperature only.  
 Thus, it varies substantially depending on the water bath or piping shape.

### Example of conventional units (Reference)

Heat quantity by cooled substance (per unit time) **Q**: Unknown [cal/h] → [W]  
 Cooled substance : Water  
 Cooled substance weight **m** : (=  $\rho \times V$ ) [kgf]  
 Cooled substance weight volume ratio  $\gamma$  : 1 [kgf/L]  
 Cooled substance total volume **V** : 20 [L]  
 Cooled substance specific heat **C** : 1.0 x 10<sup>3</sup> [cal/(kgf·°C)]  
 Cooled substance temperature when cooling begins **To** : 32 [°C]  
 Cooled substance temperature after t hour **Tt**: 20 [°C]  
 Cooling temperature difference  $\Delta T$  : 12 [°C] (=  $T_0 - T_t$ )  
 Cooling time  $\Delta t$  : 15 [min]  
 Conversion factor: hours to minutes : 60 [min/h]  
 Conversion factor: kcal/h to kW : 860 [(cal/h)/W]

$$Q = \frac{m \times C \times (T_0 - T_t)}{\Delta t \times 860} = \frac{\gamma \times V \times 60 \times C \times \Delta T}{\Delta t \times 860}$$

$$= \frac{1 \times 20 \times 60 \times 1.0 \times 10^3 \times 12}{15 \times 860}$$

$$\approx 1120 \text{ [W]}$$

Cooling capacity = Considering a safety factor of 20%,

$$1120 \text{ [W]} \times 1.2 = \boxed{1344 \text{ [W]}}$$

## Precautions on Cooling Capacity Calculation

### 1. Heating capacity

When the circulating fluid temperature is set above room temperature, it needs to be heated by the thermo-chiller. The heating capacity depends on the circulating fluid temperature. Consider the radiation rate and heat capacity of the user's equipment and check beforehand if the required heating capacity is provided.

### 2. Pump capacity

#### <Circulating fluid flow rate>

Circulating fluid flow rate varies depending on the circulating fluid discharge pressure. Consider the installation height difference between the thermo-chiller and the user's equipment, and the piping resistance such as circulating fluid pipings, or piping size, or piping curves in the machine. Check beforehand if the required flow is achieved, using the pump capacity curves.

#### <Circulating fluid discharge pressure>

Circulating fluid discharge pressure has the possibility to increase up to the maximum pressure in the pump capacity curves. Check beforehand if the circulating fluid pipings or circulating fluid circuit of the user's equipment are fully durable against this pressure.

## Circulating Fluid Typical Physical Property Values

### 1. This catalog uses the following values for density and specific heat in calculating the required cooling capacity.

Density  $\rho$ : 1 [kg/L] (or, using conventional units, weight volume ratio  $\gamma = 1$  [kgf/L])  
 Specific heat **C**: 4.19 x 10<sup>3</sup> [J/(kg·K)] (or, using conventional units, 1 x 10<sup>3</sup> [cal/(kgf·°C)])

### 2. Values for density and specific heat change slightly according to temperature shown below. Use this as a reference.

#### Water

Physical property value Temperature	Density $\rho$ [kg/L]	Specific heat C [J/(kg·K)]	Conventional units	
			Weight volume ratio $\gamma$ [kgf/L]	Specific heat C [cal/(kgf·°C)]
5°C	1.00	4.2 x 10 <sup>3</sup>	1.00	1 x 10 <sup>3</sup>
10°C	1.00	4.19 x 10 <sup>3</sup>	1.00	1 x 10 <sup>3</sup>
15°C	1.00	4.19 x 10 <sup>3</sup>	1.00	1 x 10 <sup>3</sup>
20°C	1.00	4.18 x 10 <sup>3</sup>	1.00	1 x 10 <sup>3</sup>
25°C	1.00	4.18 x 10 <sup>3</sup>	1.00	1 x 10 <sup>3</sup>
30°C	1.00	4.18 x 10 <sup>3</sup>	1.00	1 x 10 <sup>3</sup>
35°C	0.99	4.18 x 10 <sup>3</sup>	0.99	1 x 10 <sup>3</sup>
40°C	0.99	4.18 x 10 <sup>3</sup>	0.99	1 x 10 <sup>3</sup>

#### 15% Ethylene Glycol Aqueous Solution

Physical property value Temperature	Density $\rho$ [kg/L]	Specific heat C [J/(kg·K)]	Conventional units	
			Weight volume ratio $\gamma$ [kgf/L]	Specific heat C [cal/(kgf·°C)]
5°C	1.02	3.91 x 10 <sup>3</sup>	1.02	0.93 x 10 <sup>3</sup>
10°C	1.02	3.91 x 10 <sup>3</sup>	1.02	0.93 x 10 <sup>3</sup>
15°C	1.02	3.91 x 10 <sup>3</sup>	1.02	0.93 x 10 <sup>3</sup>
20°C	1.01	3.91 x 10 <sup>3</sup>	1.01	0.93 x 10 <sup>3</sup>
25°C	1.01	3.91 x 10 <sup>3</sup>	1.01	0.93 x 10 <sup>3</sup>
30°C	1.01	3.91 x 10 <sup>3</sup>	1.01	0.94 x 10 <sup>3</sup>
35°C	1.01	3.91 x 10 <sup>3</sup>	1.01	0.94 x 10 <sup>3</sup>
40°C	1.01	3.92 x 10 <sup>3</sup>	1.01	0.94 x 10 <sup>3</sup>

\* Shown above are reference values. Contact circulating fluid supplier for details.





# HRSE Series Specific Product Precautions 1

Be sure to read this before handling the products. For safety instructions and temperature control equipment precautions, refer to the “Handling Precautions for SMC Products” and the “Operation Manual” on the SMC website: <https://www.smcworld.com>

## Design

### Warning

#### 1. This catalog shows the specifications of a single unit.

- 1) Check the specifications of the single unit (contents of this catalog) and thoroughly consider the adaptability between the user's system and this unit.
- 2) Although a protection circuit as a single unit is installed, prepare a drain pan, water leakage sensor, discharge air facility, and emergency stop equipment, depending on the user's operating conditions. Also, the user is requested to carry out a safety design for the whole system.

#### 2. When attempting to cool areas that are open to the atmosphere (tanks, pipes), plan your piping system accordingly.

When cooling open-air external tanks, arrange the piping so that there are coil pipes for cooling inside the tanks and to carry back the entire flow volume of circulating fluid that is released.

#### 3. Use non-corrosive material for circulating fluid contact parts.

Using corrosive materials such as aluminum or iron for fluid contact parts such as piping may cause clogging or leakage in the circulating fluid circuit. Provide protection against corrosion when you use the product.

## Selection

### Warning

#### 1. Model selection

When selecting a thermo-chiller model, the amount of heat generation from the user's equipment must be known. Obtain this value, referring to “Cooling Capacity Calculation” on pages 222 and 223 before selecting a model.

## Handling

### Warning

#### 1. Thoroughly read the operation manual.

Read the operation manual completely before operation, and keep the manual where it can be referred to as necessary.

## Transportation/Carriage/Movement

### Warning

1. This product is heavy. Pay attention to safety and the position of the product when it is transported, carried, and moved.
2. Read the operation manual carefully before moving the product after unpacking.

### Caution

1. Never put the product down on its side as this may cause failure.

The product will be delivered in the packaging shown below.

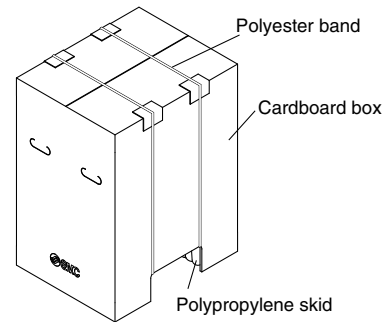

Model	Weight [kg]	Dimensions [mm]
HRSE012-A-10 HRSE018-A-10	35	Height 745 x Width 465 x Depth 575
HRSE012-A-10-T HRSE018-A-10-T	42	Height 745 x Width 465 x Depth 620
HRSE012-A-20 HRSE018-A-20 HRSE024-A-20	38	Height 745 x Width 465 x Depth 575
HRSE012-A-20-T HRSE018-A-20-T HRSE024-A-20-T	45	Height 745 x Width 465 x Depth 620
HRSE012-A-23 HRSE018-A-23 HRSE024-A-23	41	Height 790 x Width 470 x Depth 580
HRSE012-A-23-T HRSE018-A-23-T HRSE024-A-23-T	48	Height 790 x Width 470 x Depth 580

### Caution

If this product is to be transported after delivery, please use the original packaging the product was delivered in. If other packaging is to be used, carefully package the product so as to prevent the product from incurring any damage during transport.



# HRSE Series

## Specific Product Precautions 2

Be sure to read this before handling the products. For safety instructions and temperature control equipment precautions, refer to the “Handling Precautions for SMC Products” and the “Operation Manual” on the SMC website: <https://www.smcworld.com>

### Operating Environment/Storage Environment

#### Warning

**1. Do not use in the following environment as it will lead to a breakdown.**

- 1) Outdoors
- 2) In locations where water, water vapor, salt water, and oil may splash on the product.
- 3) In locations where there are dust and particles.
- 4) In locations where corrosive gases, organic solvents, chemical fluids, or flammable gases are present. (This product is not explosion proof.)
- 5) In locations where the ambient temperature exceeds the limits as mentioned below.

During transportation/storage: 0 to 50°C (But as long as water or circulating fluid are not left inside the pipings)

During operation: • Power supply 100 V type: 5 to 35°C  
• Power supply 200/230 V type: 5 to 40°C

- 6) In locations where the ambient humidity is out of the following range or where condensation occurs.

During transportation/storage: 15 to 85%

During operation: 30 to 70%

- 7) In locations which receive direct sunlight or radiated heat.
- 8) In locations where there is a heat source nearby and the ventilation is poor.
- 9) In locations where temperature substantially changes.
- 10) In locations where strong magnetic noise occurs. (In locations where strong electric fields, strong magnetic fields and surge voltage occur.)
- 11) In locations where static electricity occurs, or conditions which make the product discharge static electricity.
- 12) In locations where high frequency occurs.
- 13) In locations where damage is likely to occur due to lightning.
- 14) In locations at an altitude of 3000 m or higher (Except during storage and transportation)

\* For altitudes of 1000 m or higher

Because of lower air density, the heat radiation efficiencies of the devices in the product will be lower in the location at an altitude of 1000 m or higher.

Therefore, the maximum ambient temperature to use and the cooling capacity will lower according to the descriptions in the table below.

Select the thermo-chiller considering the descriptions.

① Upper limit of ambient temperature: Use the product in ambient temperature of the described value or lower at each altitude.

② Cooling capacity coefficient: The product's cooling capacity will lower to one that multiplied by the described value at each altitude.

Altitude [m]	① Upper limit of ambient temperature [°C]		② Cooling capacity coefficient
	Power supply 100 V type	Power supply 200/230 V type	
Less than 1000 m	35	40	1.00
Less than 1500 m	34	38	0.85
Less than 2000 m	33	36	0.80
Less than 2500 m	32	34	0.75
Less than 3000 m	32	32	0.70

- 15) In locations where strong impacts or vibrations occur.
- 16) In locations where a massive force strong enough to deform the product is applied or a weight from a heavy object is applied.
- 17) In locations where there is not sufficient space for maintenance.

**2. Install in an environment where the unit will not come into direct contact with rain or snow.**

These models are for indoor use only.

Do not install outdoors where rain or snow may fall on them.

**3. Conduct ventilation and cooling to discharge heat. (Air-cooled refrigeration)**

The heat which is cooled down through air-cooled condenser is discharged.

#### Warning

When using in a room which is shut tightly, ambient temperature will exceed the specification range stipulated in this catalog, which will activate the safety detector and stop the operation.

In order to avoid this situation, discharge the heat outside of a room by ventilation or cooling facilities.

**4. The product is not designed for clean room usage. It generates particles internally.**

**5. The product is not dust-proof.**

If used in an environment with dust, it may accumulate inside the product and cause not only a malfunction but also a fire hazard.

### Mounting/Installation

#### Warning

**1. Do not use the product outdoors.**

**2. Do not place heavy objects on top of this product, or step on it.**

The external panel can be deformed and danger can result.

#### Caution

**1. Install on a rigid floor which can withstand this product's weight.**

**2. When you remove casters to install the product, lift the product at least 10 mm by using adjuster-foot, etc.**

This product cannot be directly installed on the floor as some screws come out from the bottom of the product.

**3. Refer to the operation manual for this product, and secure an installation space that is necessary for the maintenance and ventilation.**

1. The heat is exhausted by ventilation of the mounted fan. If the product is operated with insufficient ventilation, ambient temperature may exceed the specification range (\*1), and this will affect the performance and life of the product. To prevent this, ensure that suitable ventilation is available (see below).

\*1 Power supply 100 V type: 35°C

Power supply 200/230 V type: 40°C

2. For installation indoors, ventilation ports and a ventilation fan should be equipped as needed.

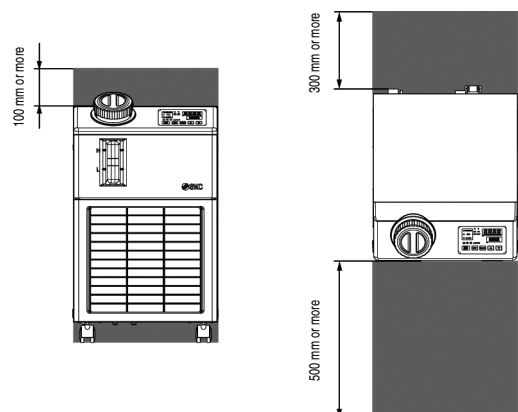



# HRSE Series Specific Product Precautions 3

Be sure to read this before handling the products. For safety instructions and temperature control equipment precautions, refer to the “Handling Precautions for SMC Products” and the “Operation Manual” on the SMC website: <https://www.smcworld.com>

## Mounting/Installation

### ⚠ Caution

<Heat radiation amount/Required ventilation rate>

Model	Heat radiation amount kW	Required ventilation rate [m <sup>3</sup> /min]	
		Differential temp. of 3°C between inside and outside of installation area	Differential temp. of 6°C between inside and outside of installation area
HRSE012-A	Approx. 2	40	20
HRSE018-A	Approx. 4	70	40
HRSE024-A	Approx. 5	90	50

## Piping

### ⚠ Caution

1. Regarding the circulating fluid pipings, consider carefully the suitability for operating pressure, temperature, and circulating fluid.

If the operating performance is not sufficient, the pipings may burst during operation. Also, the use of corrosive materials such as aluminum or iron for fluid contact parts, such as piping, may not only lead to clogging or leakage in the circulating fluid circuit but also refrigerant leakage and other unexpected problems. Provide protection against corrosion when you use the product.

2. Select the piping port size which can exceed the rated flow.

For the rated flow, refer to the pump capacity table.

3. When tightening at the circulating fluid inlet and outlet, drain port or overflow port of this product, use a pipe wrench to clamp the connection ports.

4. For the circulating fluid piping connection, install a drain pan and wastewater collection pit just in case the circulating fluid may leak.

5. This product series are constant-temperature fluid circulating machines with built-in tanks.

Do not install equipment on your system side such as pumps that forcibly return the circulating fluid to the unit. Also, if you attach an external tank that is open to the air, it may become impossible to circulate the circulating fluid. Proceed with caution.

## Electrical Wiring

### ⚠ Warning

1. Grounding should never be connected to a water line, gas line or lightning rod.

### ⚠ Caution

1. Communication cable should be prepared by user.

## Electrical Wiring

### ⚠ Caution

2. Provide a stable power supply which is not affected by surge or distortion.

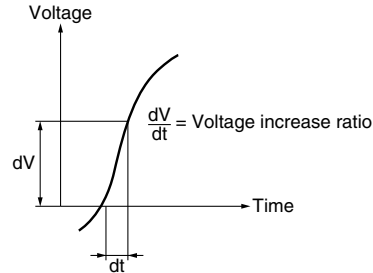

If the voltage increase ratio (dV/dt) at the zero cross should exceed 40 V/200 μsec., it may result in malfunction.

## Circulating Fluid

### ⚠ Caution

1. Avoid oil or other foreign matter entering the circulating fluid.

2. When water is used as a circulating fluid, SMC recommends the water quality shown in the following table as reference.

- Including water used for dilution of ethylene glycol aqueous solutions.
- In most areas, tap water can be used. However, if the tap water in the area is hard, there is a possibility of failure or performance decline due to limescale build-up. To soften the water and avoid problems, consider using water hardness filters.

### Tap Water (as a Circulating Fluid) Quality Standards

The Japan Refrigeration and Air Conditioning Industry Association  
JRA GL-02-1994 “Cooling water system – Circulation type – Make-up water”

	Item	Unit	Standard value	Influence	
				Corrosion	Scale generation
Standard item	pH (at 25°C)	—	6.0 to 8.0	○	○
	Electric conductivity (25°C)	[μS/cm]	100*1 to 300*1	○	○
	Chloride ion (Cl <sup>-</sup> )	[mg/L]	50 or less	○	
	Sulfuric acid ion (SO <sub>4</sub> <sup>2-</sup> )	[mg/L]	50 or less	○	
	Acid consumption amount (at pH4.8)	[mg/L]	50 or less		○
	Total hardness	[mg/L]	70 or less		○
	Calcium hardness (CaCO <sub>3</sub> )	[mg/L]	50 or less		○
Reference item	Ionic state silica (SiO <sub>2</sub> )	[mg/L]	30 or less		○
	Iron (Fe)	[mg/L]	0.3 or less	○	○
	Copper (Cu)	[mg/L]	0.1 or less	○	
	Sulfide ion (S <sub>2</sub> <sup>2-</sup> )	[mg/L]	Should not be detected.	○	
	Ammonium ion (NH <sub>4</sub> <sup>+</sup> )	[mg/L]	0.1 or less	○	
	Residual chlorine (Cl)	[mg/L]	0.3 or less	○	
	Free carbon (CO <sub>2</sub> )	[mg/L]	4.0 or less	○	

\*1 In the case of [MΩ·cm], it will be 0.003 to 0.01.

- ○: Factors that have an effect on corrosion or scale generation.
- Even if the water quality standards are met, complete prevention of corrosion is not guaranteed.

3. Use an ethylene glycol that does not contain additives such as preservatives.

4. When using an ethylene glycol aqueous solution, maintain a maximum concentration of 15%.

Overly high concentrations can cause a pump overload.

5. A magnet pump is used as a circulating pump for circulating fluid.

It is particularly impossible to use liquid including metallic powder such as iron powder.



# HRSE Series

## Specific Product Precautions 4

Be sure to read this before handling the products. For safety instructions and temperature control equipment precautions, refer to the “Handling Precautions for SMC Products” and the “Operation Manual” on the SMC website: <https://www.smcworld.com>

### Operation

#### ⚠ Warning

##### 1. Confirmation before operation

1) The fluid level of a tank should be within the specified range of “HIGH” and “LOW.”

When exceeding the specified level, the circulating fluid will overflow.

2) Remove the air.

Conduct a trial operation, looking at the fluid level.

Since the fluid level will go down when the air is removed from the user’s piping system, supply water once again when the fluid level is reduced. When there is no reduction in the fluid level, the job of removing the air is completed.

Pump can be operated independently.

##### 2. Confirmation during operation

• Check the circulating fluid temperature.

The operating temperature range of the circulating fluid is between 10 and 30°C.

When the amount of heat generated from the user’s equipment is greater than the product’s capability, the circulating fluid temperature may exceed this range. Use caution regarding this matter.

##### 3. Emergency stop method

• When an abnormality is confirmed, stop the machine immediately. After stopping operation, disconnect the power supply from the user’s equipment.

### Operation Restart Time

#### ⚠ Caution

1. Wait five minutes or more before restarting operation after it has been stopped. If the operation is restarted within five minutes, the protection circuit may activate and the operation may not start properly.

### Protection Circuit

#### ⚠ Caution

1. If operating in the below conditions, the protection circuit will activate and an operation may not be performed or will stop.

- Power supply voltage is not within the rated voltage range of ±10%.
- In case the water level inside the tank is reduced abnormally.
- Circulating fluid temperature is too high.
- Compared to the cooling capacity, the heat generation amount of the user’s equipment is too high.
- Ambient temperature is too high. (Check the ambient temperature in the specifications.)
- Ventilation hole is clogged with dust or dirt.

### Maintenance

#### ⚠ Caution

<Periodical inspection every one month>

##### 1. Clean the ventilation hole.

If the dustproof filter becomes clogged with dust or debris, a decline in cooling performance can result.

In order to avoid deforming or damaging the dustproof filter, clean it with a long-haired brush or air gun.

<Periodical inspection every three months>

##### 1. Inspect the circulating fluid.

1) When using tap water

• Replacement of tap water

Failure to replace the tap water can lead to the development of bacteria or algae. Replace it regularly depending on your usage conditions.

• Tank cleaning

Consider whether dirt, slime or foreign matter may be present in the circulating fluid inside the tank, and carry out regular cleanings of the tank.

2) When using ethylene glycol aqueous solution

Use a concentration meter to confirm that the concentration does not exceed 15%.

Dilute or add as needed to adjust the concentration.

<Periodical inspection during the winter season>

##### 1. Make water-removal arrangements beforehand.

If there is a risk of the circulating fluid freezing when the product is stopped, release the circulating fluid in advance.

##### 2. Consult a professional.

For additional methods to prevent freezing (such as commercially available tape heaters, etc.), consult a professional for advice.

#### ■ Refrigerant with GWP reference

Refrigerant	Global Warming Potential (GWP)		
	Regulation (EU) 2024/573, AIM Act 40 CFR Part 84	Fluorocarbon Emissions Control Act (Japan) GWP value labeled on products	GWP value to be used for reporting the calculated amount of leakage
R134a	1,430	1,430	1,300
R404A	3,922	3,920	3,940
R407C	1,774	1,770	1,620
R410A	2,088	2,090	1,920
R448A	1,386	1,390	1,270
R454C	146	145	146

- \* This product is hermetically sealed and contains fluorinated greenhouse gases (HFC). When this product is sold on the market in the EU after January 1, 2017, it needs to be compliant with the quota system of the F-Gas Regulation in the EU.
- \* See specification table for refrigerant used in the product.