

Made to Order

Common Specifications



1	-XB5	Oversized rod cylinder	P.1445
2	-XB6	Heat resistant cylinder (-10 to 150°C)	P.1446
3	-XB7	Cold resistant cylinder (-40 to 70°C)	P.1448
4	-XB9	Low speed cylinder (10 to 50 mm/s)	P.1449
5	-XB10	Intermediate stroke (Using exclusive body)	P.1450
6	-XB10A	Intermediate stroke (Spacer-installed type)	P.1455
7	-XB11	Long stroke type	P.1456
8	-XB12	External stainless steel cylinder	P.1460
9	-XB13	Low speed cylinder (5 to 50 mm/s)	P.1461
10	-XB14	Cylinder with heat resistant auto switch	P.1462
11	-XB19	High speed type	P.1463
12	-XB20	Stroke adjustment unit with adjustment bolt	P.1464
13	-XB22	Shock absorber soft type RJ series type	P.1468
14	-XC2(A)	Rod end length extended 10 mm	P.1472
15	-XC3	Special port location	P.1473
16	-XC4	With heavy duty scraper	P.1477
17	-XC5	Heat resistant cylinder (-10 to 110°C)	P.1484
18	-XC6	Made of stainless steel	P.1485
19	-XC7	Tie-rod, cushion valve, tie-rod nut, etc. made of stainless steel	P.1491
20	-XC8	Adjustable stroke cylinder/Adjustable extension type	P.1492
21	-XC9	Adjustable stroke cylinder/Adjustable retraction type	P.1498
22	-XC10	Dual stroke cylinder/Double rod type	P.1503
23	-XC11	Dual stroke cylinder/Single rod type	P.1508
24	-XC12	Tandem cylinder	P.1516
25	-XC13	Auto switch rail mounting type	P.1518
26	-XC17	Pin cylinder with rod quenched	P.1523
27	-XC19	Intermediate stroke (Spacer type)	P.1524
28	-XC20	Head cover axial port	P.1525
29	-XC22	Fluororubber seals	P.1526
30	-XC24	With magnetic shielding plate	P.1528
31	-XC25	No fixed throttle of connection port	P.1528
32	-XC26	With split pins for double clevis pin/double knuckle joint pin and flat washers	P.1529
33	-XC26□	Double clevis width/Double knuckle width 12.5 mm, 16.5 mm, 19.5 mm: With double clevis, double knuckle joint	P.1531
34	-XC27	Double clevis and double knuckle joint pins made of stainless steel	P.1532
35	-XC28	Compact flange made of SS400	P.1533
36	-XC29	Double knuckle joint with spring pin	P.1534
37	-XC30	Rod side trunnion	P.1535
38	-XC34	Non-rotating plate with workpiece mounting screw (No extended part on the rod end)	P.1537
39	-XC35	With coil scraper	P.1538
40	-XC36	With boss in rod side	P.1544
41	-XC37	Larger throttle diameter of connection port	P.1544
42	-XC38	Vacuum (Rod through-hole)	P.1545
43	-XC42	Built-in shock absorber in head cover side	P.1546
44	-XC51	With hose nipple	P.1547
45	-XC52	Mounting nut with set screw	P.1547
46	-XC56	With knock pin holes	P.1548
47	-XC57	Rodless cylinder with floating joint	P.1552
48	-XC65	Made of Stainless Steel (Combination of XC7 and XC68)	P.1554
49	-XC67	Dust seal band NBR lining specifications	P.1555
50	-XC68	Made of stainless steel (with hard chrome plated piston rod)	P.1555
51	-XC69	MGP series with shock absorber	P.1556
52	-XC71	Helical insert thread specifications	P.1558
53	-XC72	Without built-in auto switch magnet	P.1558
54	-XC73	Built-in cylinder with lock (CDNG)	P.1559
55	-XC74	With front plate for MGG cylinder	P.1562
56	-XC78	Auto switch mounting special dimensions at stroke end	P.1563
57	-XC82	Bottom mounting type	P.1564

Made to Order Common Specifications

58	-XC83	Built-in cylinder with lock (MDNB).....	P.1565
59	-XC85	Grease for food processing equipment.....	P.1568
60	-XC86	With rod end bracket.....	P.1569
61	-XC87	Cylinder with one-way lock/heavy duty specifications.....	P.1570
62	-XC88	Spatter resistant coil scraper, Lube-retainer, Grease for welding (Piston rod: Stainless steel 304) ...	P.1571
63	-XC89	Spatter resistant coil scraper, Lube-retainer, Grease for welding (Piston rod: S45C).....	P.1571
64	-XC91	Spatter resistant coil scraper, Grease for welding (Piston rod: S45C).....	P.1572
65	-XC92	Dust resistant actuator.....	P.1580
66	-XC93	With greater water resistance + stable lubrication function.....	P.1583
67	-XC102	Lock release specification.....	P.1584
68	-XC103	Cylinder for the foot type or the rod flange type mounting bracket.....	P.1585
69	-XC104	Built-in cylinder with lock (MWB).....	P.1585-1

How to Order When Combining Made-to-Order Specifications

How to order when combining two specifications: simple specials (XA□) and made-to-order common specifications (XB□, XC□).

■ How to Order Example: 1 (Enter the symbol in alphabetical order.)

CQ2B25 - 30D - XA7B6

Note) "X" of XB6 is not necessary.

● Made to Order

Symbol	Specifications
XA7	Change of rod end shape
XB6	Heat resistant cylinder

■ How to Order Example: 2 (Enter the symbol in numerical order when alphabetical letters are the same.)

CDQ2B25 - 30DZ - M9BW - XC4C6

Note) "X" of XC6 is not necessary.

● Made to Order

Symbol	Specifications
XC4	With heavy duty scraper
XC6	Made of stainless steel

* When combining special order options, the symbols should be listed in alphabetical or numerical order. However, due to product-specific production restrictions, it may not be possible to easily combine them. Contact SMC if you require a custom combination.

Made to Order Common Specifications: -XB5: Oversized Rod Cylinder



1 Oversized Rod Cylinder

Symbol
-XB5

A cylinder that has been made stronger through the use of a piston rod with a larger diameter. It is used for long stroke applications that pose the risk of bending or buckling of the piston rod.
(Please contact SMC if a lateral load must be applied to it.)

How to Order

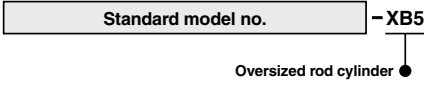

Applicable Series

Series	Description	Model	Action	Note	Vol. no. (for std model)
MB	Air cylinder	MB	Double acting, Single rod		Web Catalog
MB1	Air cylinder	MB1	Double acting, Single rod		
CA2	Air cylinder	CA2	Double acting, Single rod		
CS1	Air cylinder	CS1	Double acting, Single rod		
CS2	Air cylinder	CS2	Double acting, Single rod/Double acting, Double rod	Applicable to ø160 to ø320	

Dimensions (Dimensions other than below are the same as standard type.)

MB, MB1 series

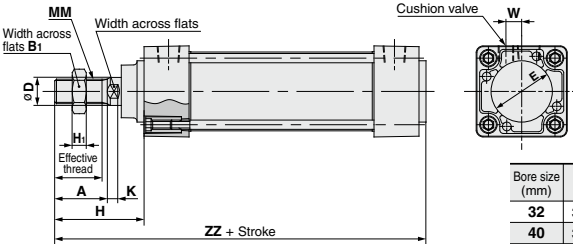

Bore size (mm)	A	Effective thread length	B ₁	øD	H	H ₁	K	Width across flats	MM	W	ZZ
32	30	27	22	16	51	8	6	14	M14 x 1.5	7.2	139
40	35	32	27	20	58	11	7	18	M18 x 1.5	9.7	146
50	40	37	32	25	68	13	10	22	M22 x 1.5	10.5	166
63	40	37	32	25	68	13	10	22	M22 x 1.5	12	166
80	40	37	41	30	74	16	10	26	M26 x 1.5	14	192
100	50	47	46	36	90	18	16	31	M30 x 1.5	15	208

CA2 series

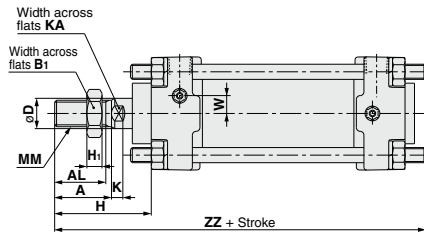

Bore size (mm)	A	AL	B ₁	øD	H	H ₁	K	KA	MM	W	ZZ
40	35	32	27	20	58	11	7	18	M18 x 1.5	9	153
50	40	37	32	25	71	13	11	22	M22 x 1.5	9	172
63	40	37	32	25	71	13	11	22	M22 x 1.5	9	183
80	40	37	41	30	72	16	11	26	M26 x 1.5	0	205
100	50	47	46	36	85	18	15	31	M30 x 1.5	0	228

CS1 series

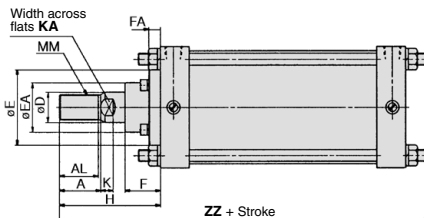

Bore size (mm)	A	AL	D	E	EA	F	FA	H	K	KA	MM	ZZ
125	63	60	50	115	74	48	17	135	20	46	M45 x 1.5	260
140	71	67	60	140	86	60	20	160	25	56	M56 x 2.0	285
160	71	67	60	140	86	60	20	160	25	56	M56 x 2.0	296.5
180	80	76	70	140	96	60	20	175	30	65	M64 x 2.0	325
200	80	76	70	140	96	60	20	175	30	65	M64 x 2.0	325

Made to Order Common Specifications: -XB5: Oversized Rod Cylinder



1 Oversized Rod Cylinder

Symbol
-XB5

Dimensions (Dimensions other than below are the same as standard type.)

CS2 series

Single rod type ø180 to ø250

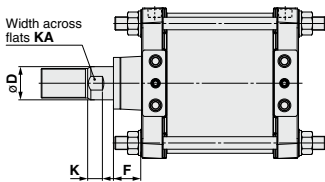

ø320

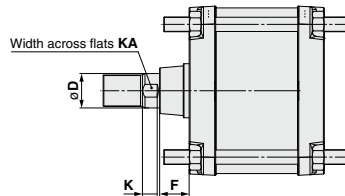

Double rod type ø180 to ø250

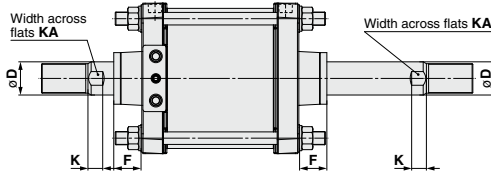

ø320

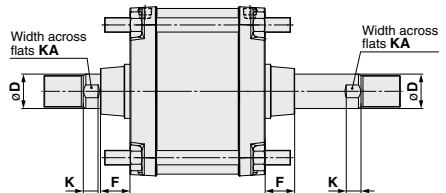

	D	F	K	KA
ø180	45	37	20	41
ø200	50	41	20	46
ø250	60	52	25	56
ø320	70	60	30	65

Made to Order Common Specifications: -XB6: Heat Resistant Cylinder (-10 to 150°C)



2 Heat Resistant Cylinder (-10 to 150°C)

Symbol
-XB6

Air cylinder which changed the seal material and grease, so that it could be used even at higher temperature up to 150 from -10°C.

Applicable Series

Series	Description	Model	Action	Note	Vol. no. (for std model)
CJP2	Pin cylinder	CJP2	Double acting, Single rod	Except clevis, trunnion type, with auto switch, ø4. Packing set (6)	
CJ2	Air cylinder	CJ2-Z	Double acting, Single rod	Except with air cushion and auto switch, rod end bracket T, U	
		CJ2W-Z	Double acting, Double rod	Except with air cushion and auto switch, rod end bracket T, U	
CM2	Air cylinder	CM2-Z	Double acting, Single rod	Except with rod boot and with auto switch	
		CM2W-Z	Double acting, Double rod	Except with rod boot and with auto switch	
	Non-rotating rod type	CM2K-Z	Double acting, Single rod	Except with rod boot and with auto switch	
		CM2KW-Z	Double acting, Double rod	Except with auto switch	
	Direct mount type	CM2R-Z	Double acting, Single rod	Except with auto switch	
Non-rotating rod, Direct mount type	CM2RK-Z	Double acting, Single rod	Except with auto switch		
	End lock cylinder	CBM2	Double acting, Single rod	Except with rod boot and with auto switch	
CG1	Air cylinder	CG1-Z	Double acting, Single rod	Except with auto switch. Without a bumper for cylinders with rubber bumper	
		CG1W-Z	Double acting, Double rod	Except with auto switch. Without a bumper for cylinders with rubber bumper	
	Direct mount type	CG1R-Z	Double acting, Single rod	Except with auto switch. Without a bumper for cylinders with rubber bumper	
MB	Air cylinder	MB-Z	Double acting, Single rod	Except without air cushion and with auto switch	
		MBW-Z	Double acting, Double rod	Except without air cushion and with auto switch	
MB1	Air cylinder	MB1-Z	Double acting, Single rod	Except without air cushion and with auto switch	
		MB1W-Z	Double acting, Double rod	Except without air cushion and with auto switch	
CA2	Air cylinder	CA2-Z	Double acting, Single rod	Except with auto switch	
		CA2W-Z	Double acting, Double rod	Except with auto switch	
	End lock cylinder	CBA2	Double acting, Single rod	Except with auto switch	
CS1	Air cylinder	CS1□N	Double acting, Single rod	Except with auto switch. Applicable bore size (ø125 to ø200)	
		CS1W□N	Double acting, Double rod		
CS2	Air cylinder	CS2	Double acting, Single rod	Except with auto switch	Web Catalog
		CS2W	Double acting, Double rod	Except with auto switch	
CUJ	Mini free mount cylinder	CUJ	Double acting, Single rod	Except with auto switch and ø4	
CU	Free mount cylinder	CU	Double acting, Single rod	Except with auto switch	
	Non-rotating rod type	CUK	Double acting, Single rod	Except with auto switch	
	Long stroke	CU	Double acting, Single rod	Except with auto switch	
	Long stroke, Non-rotating rod	CUK	Double acting, Single rod	Except with auto switch	
CQS	Compact cylinder	CQS	Double acting, Single rod	Except with rubber bumper and auto switch	
		CQSW	Double acting, Double rod	Except with rubber bumper and auto switch	
CQ2	Compact cylinder	CQ2-Z	Double acting, Single rod	Except with rubber bumper and auto switch, air-hydro type	
		CQ2W-Z	Double acting, Double rod	Except with rubber bumper and auto switch, air-hydro type	
	Axial piping type (Centralized piping type)	CQP2	Double acting, Single rod	Except with rubber bumper and auto switch, air-hydro type	
		CQ2K-Z	Double acting, Single rod	Except with rubber bumper and auto switch	
Non-rotating rod type	CQ2KW-Z	Double acting, Double rod	Except with rubber bumper and auto switch		
CG5	Stainless cylinder	CG5	Double acting, Single rod	Except with auto switch. Without a bumper for cylinders with a rubber bumper (Grease for non-food is used.)	
CY3	Magnetically coupled rodless cylinder	CY3B-Z	Basic type	Without a bumper	
		CY3B		Without a bumper	
MK	Rotary clamp	MK-Z	Double acting	Except with auto switch, ø12 and ø16	
MGP	Compact guide cylinder	MGPM-Z	Double acting	Except with auto switch. No rubber bumper is equipped.	
MGQ	Compact guide cylinder	MGQ	Double acting	Except with auto switch, ø12 to ø25 of MGQL (Ball bushing type)	
MGG	Guide cylinder	MGG	Double acting	Except with auto switch. No shock absorber and rubber bumper are equipped.	
MGC	Guide cylinder	MGC	Double acting	Except with auto switch	
CXSJ	Dual rod cylinder	CXSJ	Compact type	Except with auto switch	
CXS		CXS	Basic type	Except with auto switch	

How to Order

Standard model no.	-XB6
Heat resistant cylinder	

Specifications

Ambient temperature range	-10 to 150°C (0 to 150°C for CS1, CS2 series)
Seals materials	Fluororubber
Grease	Heat resistant grease
Specifications other than above and external dimensions	Same as standard type

Warning Precautions

Be aware that smoking cigarettes, etc. after your hands have come into contact with the grease used in this cylinder can create a gas that is hazardous to humans.

- Note 1) Operate without lubrication from a pneumatic system lubricator.
 Note 2) Please contact SMC for details on the maintenance intervals for this cylinder, which differ from those of the standard cylinder.
 Note 3) In principle, it is impossible to make built-in magnet type and the one with auto switch. But, as for the one with auto switch, and the heat resistant cylinder with heat resistant auto switch, since it will be differed depending on the series, please contact SMC.
 Note 4) Piston speed is ranged from 50 to 500 mm/s. But, for MGQ□80, □100 and MGQ□30, □100, it will be 50 to 400 mm/s; 50 to 200 mm/s for the MK series. The piston speed for the CY3B and CY3B-Z series is 50 to 400 mm/s. Note that the max. piston speed changes depending on the ambient temperature.
 Note 5) Please contact SMC for the CQ2, CQS, MGP and MGQ series with rubber bumper.
 Note 6) As for the ambient temperature range of the CY3B and CY3B-Z series, since the magnetic holding force will be varied depending on the operating conditions, make sure that by referring to the next page.
 Note 7) The ambient temperature range of the CY3B and CY3B-Z series is 50 to 150°C.
 Note 8) Refer to the construction of the standard type for the details of the packing set for CJP2□6,10 and 16.

Made to Order Common Specifications: -XB6: Heat Resistant Cylinder (-10 to 150°C)



2 Heat Resistant Cylinder (-10 to 150°C)

Symbol
-XB6

CY3B series

How to Order

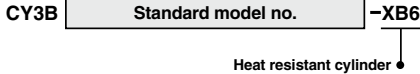

Specifications

Model	CY3B-Z, CY3B
Bore size (mm)	ø6 to ø63
Ambient and fluid temperature	50 to 150°C*
Maximum operating pressure	0.5 MPa
Piston speed	50 to 400 mm/s*

* When the temperature is in the less than 100°C range, operate at 200 mm/s or less.

* External dimensions are identical to the standard model.

Operating Pressure Limit for Intermediate Stop and Vertical Operation

Maximum operating pressure at the intermediate stop	0.4 MPa*
---	----------

* Use caution that the magnet coupling will be removed, if it is used to stop in an intermediate stroke by an external stopper with the operating pressure over 0.4 MPa.

Magnetic Holding Force

Bore size (mm)	6	10	15	20	25	32	40	50	63
Holding force (at 150°C)	14.4	40.0	90.1	160	250	410	641	1000	1590
Holding force (at 100°C)	17.2	47.9	107	192	299	490	766	1190	1900

MGC series

How to Order

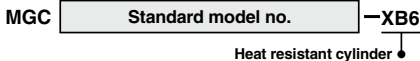

Dimensions (Dimensions other than below are the same as standard type.)

MGCLB series

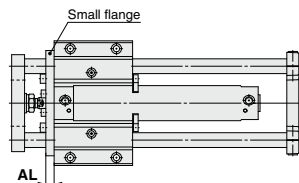

Bore size (mm)	AL
20	9
25	9
32	9
40	12
50	12

Temperature Range for Operating Cylinder and Piston Speed

- For piston speeds of more than 200 mm/s when the operating temperature is within the 60 to 100°C range, a special order product is available separately.
- When using with the operating temperature from 50 up to 100°C, and the piston speed of less than 200 mm/s, XB6 specifications can be used.
- As for XB6, regarding the temperature range (over 50 to 60°C) which overlaps the one of standard products, consider the tendency of operating temperature (upper, lower limits), then choose a model.

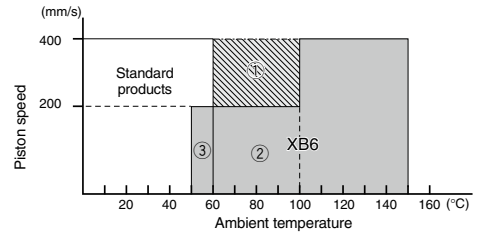

When the operating temperature fluctuates between 50°C or less and 100°C or more, this may result in an unstable operating speed and a reduced service life.

<Reference>

Maintenance cycle for XB6 could vary substantially, depending on the operating condition and the ambient temperature. Even if using in our recommended range, as a guide, conduct it in around 1/2 intervals, compared to the standard products.

Dimensions (Dimensions other than below are the same as standard type.)

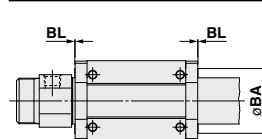

Bore size (mm)	BA	BL
6	—	—
10	—	—
15	—	—
20	—	—
25	37	0.3
32	—	—
40	—	—
50	68.5	0.6
63	—	—

MGP series

How to Order

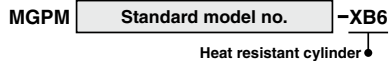

Dimensions

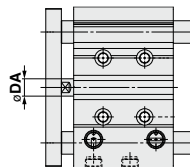

Bore size (mm)	DA
12	(6)
16	(8)
20	(10)
25	(10)
32	(14)
40	(14)
50	20
63	20
80	25
100	30

The dimensions in () are the same as standard type.

Made to Order Common Specifications: -XB7: Cold Resistant Cylinder (-40 to 70°C)



Symbol

-XB7

3 Cold Resistant Cylinder (-40 to 70°C)

Air cylinder which changed the seal material and grease, so that it could be used even at lower temperature down to -40°C.

Applicable Series

Series	Description	Model	Action	Note	Vol. no. (for std model)
CJP2	Pin cylinder	CJP2	Double acting, Single rod	Except clevis, trunnion type, with auto switch, ø4. Packing set (7)	Web Catalog
CJ2	Air cylinder	CJ2-Z	Double acting, Single rod	Except with air cushion and auto switch, rod end bracket, pivot bracket	
		CJ2W-Z	Double acting, Double rod	Except with air cushion and auto switch, rod end bracket, pivot bracket	
CM2	Air cylinder	CM2-Z	Double acting, Single rod	Except with rod boot, with air cushion, with auto switch, rod end bracket, pivot bracket	
		CM2W-Z	Double acting, Double rod	Except with rod boot, with air cushion, with auto switch, rod end bracket, pivot bracket	
	Direct mount type	CM2R-Z	Double acting, Single rod	Except with air cushion, auto switch	
CG1	Air cylinder	CG1-Z	Double acting, Single rod	Except with air cushion, auto switch. Cylinders with a rubber bumper have no bumper.	
		CG1W-Z	Double acting, Double rod	Except with air cushion, auto switch. Cylinders with a rubber bumper have no bumper.	
	Direct mount type	CG1R-Z	Double acting, Single rod	Except with air cushion, auto switch. Cylinders with a rubber bumper have no bumper.	
CU	Free mount cylinder	CU	Double acting, Single rod	Except with auto switch	
	Non-rotating rod type	CUK	Double acting, Single rod	Except with auto switch	
	Long stroke	CU	Double acting, Single rod	Except with auto switch	
	Long stroke, Non-rotating rod	CUK	Double acting, Single rod	Except with auto switch	
CQS	Compact cylinder	CQS	Double acting, Single rod	Except with auto switch, with rubber bumper, with bracket	
		CQSW	Double acting, Double rod	Except with auto switch, with rubber bumper, with bracket	
CQ2	Compact cylinder	CQ2-Z	Double acting, Single rod	ø12 to ø40. Except with auto switch magnet, with rubber bumper, with bracket	
		CQ2W-Z	Double acting, Double rod	ø12 to ø40. Except with auto switch magnet, with rubber bumper, with bracket	
	Axial piping type (Centralized piping type)	CQP2	Double acting, Single rod	ø12 to ø40. Except with auto switch magnet, with rubber bumper, with bracket	

How to Order

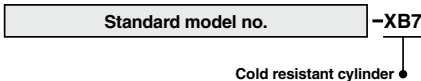

Specifications

Ambient temperature range	-40 to 70°C
Seals material	Low nitrile rubber
Grease	Cold resistant grease
Auto switch	Not mountable
Dimensions	Same as standard type
Additional specifications	Same as standard type

Warning Precautions

Be aware that smoking cigarettes, etc. after your hands have come into contact with the grease used in this cylinder can create a gas that is hazardous to humans.

- Note 1) Operate without lubrication from a pneumatic system lubricator.
- Note 2) Use dry air which is suitable for heatless air dryer, etc. not to cause the moisture to be frozen.
- Note 3) Please contact SMC for details on the maintenance intervals for this cylinder, which differ from those of the standard cylinder.
- Note 4) Mounting auto switch is impossible.
- Note 5) Please contact SMC for the one with rubber bumper for CQ2, CQS.
- Note 6) No cushion type is adopted.
Piston speed is ranged from 50 to 500 mm/s.
- Note 7) Refer to the construction of the standard type for the details of the packing set for CJP2□6,10 and 16.

Made to Order Common Specifications: -XB9: Low Speed Cylinder (10 to 50 mm/s)



4 Low Speed Cylinder (10 to 50 mm/s)

Symbol
-XB9

Even if driving at lower speeds 10 to 50 mm/s, there would be no stick-slip phenomenon and it can run smoothly.

Applicable Series

Series	Description	Model	Action	Note	Vol. no. (for std model)
CJ2	Air cylinder	CJ2-Z	Double acting, Single rod	Except with air cushion	Web Catalog
	Air cylinder	CM2-Z	Double acting, Single rod	Except air-hydro, with air cushion, with rod boot	
CM2	Direct mount type	CM2R-Z	Double acting, Single rod	Except with air cushion	
	End lock cylinder	CBM2	Double acting, Single rod	Except with rod boot, with air cushion	
CG1	Air cylinder	CG1-Z	Double acting, Single rod	Except with rod boot, with air cushion	
	Direct mount type	CG1R-Z	Double acting, Single rod	Except with air cushion	
CU	Free mount cylinder	CU	Double acting, Single rod		
	Non-rotating rod type	CUK	Double acting, Single rod		
	Long stroke standard type	CU	Double acting, Single rod		
	Long stroke, Non-rotating rod type	CUK	Double acting, Single rod		
CQS	Compact cylinder	CQS	Double acting, Single rod	Except long stroke	
		CQSW	Double acting, Double rod		
CQ2	Compact cylinder	CQ2-Z	Double acting, Single rod	Except long stroke and large bore type	
		CQ2W-Z	Double acting, Double rod		
		CQP2	Double acting, Single rod		
MGQ	Compact guide cylinder	MGQ	Double acting		
CXS	Dual rod cylinder	CXS	Basic type		
CY	Magnetically coupled rodless cylinder	CY3B-Z	Double acting		
		CY3B	Double acting		
		CY1S-Z	Double acting		
		CY1L	Double acting		

How to Order

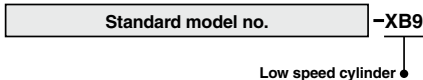

Note) Operate without lubrication from a pneumatic system lubricator.

Specifications

Piston speed	10 to 50 mm/s (CY is ranged between 15 to 50 mm/s.)
Dimensions	Same as standard type
Additional specifications	Same as standard type

Warning Precautions

Be aware that smoking cigarettes, etc. after your hands have come into contact with the grease used in this cylinder can create a gas that is hazardous to humans.

Made to Order Common Specifications: -XB10: Intermediate Stroke (Using exclusive body)



5 Intermediate Stroke (Using exclusive body) Symbol **-XB10**

Cylinder which can reduce the mounting space by using an exclusive body which does not use a spacer to achieve that the full length dimension could be shortened when an intermediate stroke other than the standard stroke is required.

Applicable Series

Series	Description	Model	Action	Note	Vol. no. (for std model)
CQS	Compact cylinder	CQS	Double acting, Single rod	Long stroke is available, too.	
		CQSW	Single acting (Spring return)		
	Anti-lateral load	CQ2□S	Double acting, Double rod		
CQ2	Compact cylinder	CQ2-Z	Double acting, Single rod		Web Catalog
		CQ2W-Z	Single acting (Spring return)		
		CQ2K-Z	Double acting, Double rod		
	Non-rotating rod type	CQ2K-Z	Double acting, Single rod	Except $\phi 12$ to $\phi 32$	
		CQ2KW	Double acting, Double rod		
	Large bore size	CQ2-Z	Double acting, Single rod		
		CQ2W-Z	Double acting, Double rod		
	Long stroke	CQ2-Z	Double acting, Single rod		
		CQ2□S-Z	Double acting, Single rod		
Anti-lateral load	CQ2-R/V	Double acting, Single rod	Applicable to $\phi 40$ to $\phi 100$		
Water resistant	CQ2W-R/V	Double acting, Double rod			
With end lock	CBO2	Double acting, Single rod			
MGP	Compact guide cylinder	MGP-Z	Double acting		
MGQ	Compact guide cylinder	MGQ	Double acting		
CY1	Magnetically coupled rodless cylinder	CY1H	Linear guide type		
		CY1F	Low profile guide type		
REA	Sine rodless cylinder	REAH	Linear guide type		
REB		REBH			

How to Order

Specifications: Same as standard type

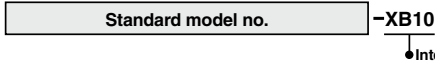

Dimensions: CQ2 Series The A and B dimensions shown below are the same as those of the standard type. (Shown for reference purposes)

Double acting, Single rod

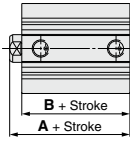

Double acting, Double rod

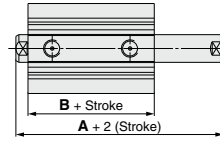

Bore size (mm)	Single rod type				Applicable stroke range (mm)
	A		B		
	49 stroke or less	51 to 99 stroke	49 stroke or less	51 to 99 stroke	
12	20.5 (31.5)	—	17 (28)	—	6 to 29
16	22 (34)	—	18.5 (30.5)	—	
20	24 (36)	—	19.5 (31.5)	—	
25	27.5 (37.5)	—	22.5 (32.5)	—	6 to 49
32	30 (40)	40 (40)	23 (33)	33 (33)	6 to 99
40	36.5 (46.5)	46.5 (46.5)	29.5 (39.5)	39.5 (39.5)	
50	38.5 (48.5)	48.5 (48.5)	30.5 (40.5)	40.5 (40.5)	
63	44 (54)	54 (54)	36 (46)	46 (46)	11 to 99
80	53.5 (63.5)	63.5 (63.5)	43.5 (53.5)	53.5 (53.5)	
100	65 (75)	75 (75)	53 (63)	63 (63)	

Bore size (mm)	Double rod type				Applicable stroke range (mm)
	A		B		
	49 stroke or less	51 to 99 stroke	49 stroke or less	51 to 99 stroke	
12	32.2 (39.4)	—	25.2 (32.4)	—	6 to 29
16	33 (43)	—	26 (36)	—	
20	35 (47)	—	26 (38)	—	
25	39 (49)	—	29 (39)	—	6 to 49
32	44.5 (54.5)	54.5 (54.5)	30.5 (40.5)	40.5 (40.5)	6 to 99
40	54 (64)	64 (64)	40 (50)	50 (50)	
50	56.5 (66.5)	66.5 (66.5)	40.5 (50.5)	50.5 (50.5)	
63	58 (68)	68 (68)	42 (52)	52 (52)	11 to 99
80	71 (81)	81 (81)	51 (61)	61 (61)	
100	84.5 (94.5)	94.5 (94.5)	60.5 (70.5)	70.5 (70.5)	

Single acting, Spring return

Bore size (mm)	Single rod type (Single acting/Return)		Applicable stroke range (mm)
	A	B	
	12	20.5 (31.5)	
16	22 (34)	18.5 (30.5)	
20	24 (36)	19.5 (31.5)	
25	27.5 (37.5)	22.5 (32.5)	6 to 9
32	30 (40)	23 (33)	6 to 9
40	36.5 (46.5)	29.5 (39.5)	
50	38.5 (48.5)	30.5 (40.5)	

* () : Denotes the dimensions of auto switch type.
* Other dimensions are the same as standard type.
Note) Applicable stroke available in 1 mm increments.

Made to Order Common Specifications: -XB10: Intermediate Stroke (Using exclusive body)



5 Intermediate Stroke (Using exclusive body)

Symbol
-XB10

Dimensions: CQ2 Series

Double acting, Single rod/Long stroke

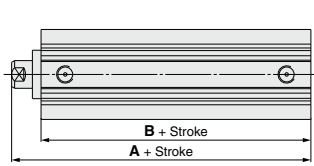

Double acting, Single rod/Large bore

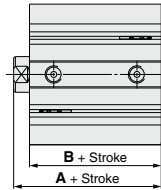

Double acting, Double rod/Large bore

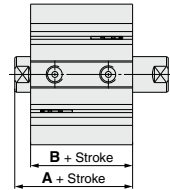

Bore size (mm)	Single rod type (Long stroke)		Applicable stroke range(mm)
	A	B	
32	62.5	45.5	101 to 299
40	72	55	
50	73.5	55.5	
63	75	57	
80	86	66	
100	97.5	75.5	

* Dimensions of "with auto switch" and those of "without auto switch" are the same.

Bore size (mm)	Single rod type		Applicable stroke range(mm)
	A	B	
125	99	83	11 to 299
140	99	83	
160	108	91	
180	119	102	
200	126	109	

* Dimensions other than listed above are the same as standard type.
Note) Applicable stroke available in 1 mm increments.

Bore size (mm)	Double rod type		Applicable stroke range(mm)
	A	B	
125	115	83	11 to 299
140	115	83	
160	125	91	
180	136	102	
200	143	109	

* Dimensions other than listed above are the same as standard type.
Note) Applicable stroke available in 1 mm increments.

Double acting, Single rod/End lock With head side locking

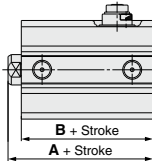

Double acting, Single rod/End lock With rod side locking

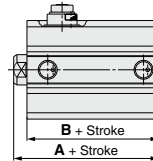

Head Side Locking

Bore size (mm)	A		B		Applicable stroke range(mm)
	24 stroke or less	26 to 99 stroke	24 stroke or less	26 to 99 stroke	
20	65.5	80.5	61	66	6 to 99
25	69	84	64	69	
32	72.5		65.5		
40	82		75		
50	83.5		75.5		
63	85		77		

Bore size (mm)	A		B		Applicable stroke range(mm)
	49 stroke or less	51 to 99 stroke	49 stroke or less	51 to 99 stroke	
80	121	136	111	116	6 to 99
100	132.5	147.5	120.5	125.5	

Rod Side Locking

Bore size (mm)	A		B		Applicable stroke range(mm)
	24 stroke or less	26 to 99 stroke	24 stroke or less	26 to 99 stroke	
20	59	80.5	54.5	66	6 to 99
25	62.5	84	57.5	69	
32	65		58		
40	71.5		64.5		
50	73.5		65.5		
63	79		71		

Bore size (mm)	A		B		Applicable stroke range(mm)
	49 stroke or less	51 to 99 stroke	49 stroke or less	51 to 99 stroke	
80	113.5	136	103.5	116	6 to 99
100	125	147.5	113	125.5	

Made to Order Common Specifications: -XB10: Intermediate Stroke (Using exclusive body)



5 Intermediate Stroke (Using exclusive body)

Symbol
-XB10

Dimensions: CQS Series

Double acting,
Single rod/Long stroke

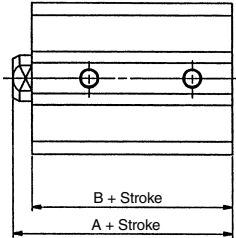

Double acting, Double rod

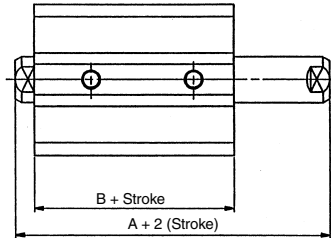

Bore size (mm)	Single rod type		Applicable stroke
	A	B	
12	20.5 (25.5)	17 (22)	6 to 29
16	20.5 (25.5)	17 (22)	
20	24 (34)	19.5 (29.5)	6 to 49
25	27.5 (37.5)	22.5 (32.5)	

(mm)

Bore size (mm)	Single rod type (Anti-lateral load)		Applicable stroke
	A	B	
12	25.5 (30.5)	22 (27)	6 to 29
16	25.5 (30.5)	22 (27)	
20	29 (39)	24.5 (34.5)	6 to 49
25	32.5 (42.5)	27.5 (37.5)	

(mm)

Bore size (mm)	Double rod type		Applicable stroke
	A	B	
12	29 (34)	22 (27)	6 to 29
16	29 (34)	22 (27)	
20	35 (45)	26 (36)	6 to 49
25	39 (49)	29 (39)	

(mm)

Bore size (mm)	Single rod type (Long stroke)		Applicable stroke
	A	B	
12	45.5	32	31 to 99
16	45.5	32	
20	55.5	41	51 to 199
25	59	44	

(mm)

Bore size (mm)	Single rod type (Single acting/Return)		Applicable stroke
	A	B	
12	20.5 (25.5)	17 (22)	6 to 9
16	20.5 (25.5)	17 (22)	
20	24 (34)	19.5 (29.5)	6 to 9
25	27.5 (37.5)	22.5 (32.5)	

(mm)

- * (): Denotes the dimensions with auto switch.
- * In the case of long stroke, dimensions of "with auto switch" and those of "without auto switch" are the same.
- * Dimensions other than listed at left are the same as standard type.
- Note) Applicable stroke available in 1 mm increments.

Made to Order Common Specifications: -XB10: Intermediate Stroke (Using exclusive body)



5 Intermediate Stroke (Using exclusive body)

Symbol
-XB10

Dimensions: MGP Series

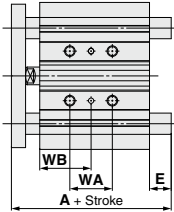

Stroke Range

Bore size (mm)	Stroke range (mm)
12, 16	11 to 249
20, 25	21 to 399
32, 40, 50, 63, 80, 100	26 to 399

* Specifications except the stroke range are the same as standard.
Note) Applicable stroke available in 1 mm increments.

MGPM-Z, MGPL-Z, MGPA-Z/WA, WB Dimensions

Bore size (mm)	Stroke range (mm)	WA				WB			
		11 to 39 st	41 to 99 st	101 to 199 st	201 to 249 st	11 to 39 st	41 to 99 st	101 to 199 st	201 to 249 st
12	11 to 249	20	40	110	200	15	25	60	105
16		24	44	110	200	17	27	60	105

Bore size (mm)	Stroke range (mm)	WA				WB					
		21 to 39 st	41 to 124 st	126 to 199 st	201 to 299 st	301 to 399 st	21 to 39 st	41 to 124 st	126 to 199 st	201 to 299 st	301 to 399 st
20	21 to 399	24	44	120	200	300	29	39	77	117	167
25		24	44	120	200	300	29	39	77	117	167

Bore size (mm)	Stroke range (mm)	WA					WB				
		26 to 49 st	51 to 124 st	126 to 199 st	201 to 299 st	301 to 399 st	26 to 49 st	51 to 124 st	126 to 199 st	201 to 299 st	301 to 399 st
32	26 to 399	24	48	124	200	300	33	45	83	121	171
40		24	48	124	200	300	34	46	84	122	172
50		24	48	124	200	300	36	48	86	124	174
63		28	52	128	200	300	38	50	88	124	174
80		28	52	128	200	300	42	54	92	128	178
100		48	72	148	220	320	35	47	85	121	171

MGPM-Z/A, E Dimensions

Bore size (mm)	A			E		
	11 to 74 st	76 to 99 st	101 to 249 st	11 to 74 st	76 to 99 st	101 to 249 st
12	42	60.5	82.5	0	18.5	40.5
16	46	64.5	92.5	0	18.5	46.5

Bore size (mm)	A			E		
	21 to 74 st	76 to 199 st	201 to 399 st	21 to 74 st	76 to 199 st	201 to 399 st
20	53	77.5	110	0	24.5	57
25	53.5	77.5	109.5	0	24	56

Bore size (mm)	A			E		
	26 to 74 st	76 to 199 st	201 to 399 st	26 to 74 st	76 to 199 st	201 to 399 st
32	75	93.5	129.5	15.5	34	70
40	75	93.5	129.5	9	27.5	63.5
50	88.5	109.5	150.5	16.5	37.5	78.5
63	88.5	109.5	150.5	11.5	32.5	73.5
80	104.5	131.5	180.5	8	35	84
100	126.5	151.5	190.5	10.5	35.5	74.5

* Dimensions except mentioned above are the same as standard type.

MGPL-Z, MGPA-Z/A, E Dimensions

Bore size (mm)	A			E		
	11 to 39 st	41 to 99 st	101 to 249 st	11 to 39 st	41 to 99 st	101 to 249 st
12	43	55	84.5	1	13	42.5
16	49	65	94.5	3	19	48.5

Bore size (mm)	A			E				
	21 to 39 st	41 to 124 st	126 to 199 st	21 to 39 st	41 to 124 st	126 to 199 st		
20	59	76	100	117.5	6	23	47	64.5
25	65.5	81.5	100.5	117.5	12	28	47	64

Bore size (mm)	A			E				
	26 to 74 st	76 to 124 st	126 to 199 st	201 to 399 st	26 to 74 st	76 to 124 st	126 to 199 st	201 to 399 st
32	79.5	96.5	116.5	138.5	20	37	57	79
40	79.5	96.5	116.5	138.5	13.5	30.5	50.5	72.5
50	91.5	112.5	132.5	159.5	19.5	40.5	60.5	87.5
63	91.5	112.5	132.5	159.5	14.5	35.5	55.5	82.5

Bore size (mm)	A			E				
	26 to 49 st	51 to 74 st	76 to 199 st	201 to 399 st	26 to 49 st	51 to 74 st	76 to 199 st	201 to 399 st
80	104.5	128.5	158.5	191.5	8	32	62	95
100	119.5	145.5	178.5	201.5	3.5	29.5	62.5	85.5

Made to Order Common Specifications: -XB10: Intermediate Stroke (Using exclusive body)



5 Intermediate Stroke (Using exclusive body)

Symbol
-XB10

Dimensions: MGQ Series

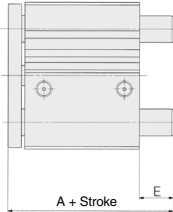

Stroke Range

Bore size (mm)	Stroke range (mm)
12, 16	11 to 99
20, 25	21 to 199
32, 40, 50, 63, 80, 100	26 to 199

* Specifications except the stroke range are the same as standard.
Note) Applicable stroke available in 1 mm increments.

MGQM (Slide bearing) A, E Dimensions

Bore size (mm)	A		E	
	11 to 99 st	11 to 99 st	11 to 99 st	11 to 99 st
12	39		0	
16	43		0	

Bore size (mm)	A		E	
	21 to 74 st	76 to 199 st	21 to 74 st	76 to 199 st
20	47	61.5	0	14.5
25	47.5	62	0	14.5

Bore size (mm)	A		E	
	26 to 199 st		26 to 199 st	
32	71.5		24	
40	71.5		17.5	
50	81		25	
63	81		20	
80	93		18.5	
100	105		21	

* Dimensions except mentioned above are the same as standard type.

MGQL (Ball bushing bearing) A, E Dimensions

Bore size (mm)	A		E	
	11 to 39 st	41 to 99 st	11 to 39 st	41 to 99 st
12	43	55	4	16
16	49	65	6	22

Bore size (mm)	A		E	
	21 to 39 st	41 to 199 st	21 to 39 st	41 to 199 st
20	57	74	10	27
25	63.5	79.5	16	32

Bore size (mm)	A		E	
	26 to 74 st	76 to 199 st	26 to 74 st	76 to 199 st
32	53	90	5.5	42.5
40	54	90	0	36
50	60	102	4	46
63	61	102	0	41
80	84	143	9.5	68.5
100	89	153	5	69

* Dimensions except mentioned above are the same as standard type.

RE_AB series

REAH Bore size – Stroke – XB10
REBH

(Refer to the table below.)

● Intermediate stroke

Strokes

Bore size	150	175	200	225	250	275	300	325	350	375	400	425	450	475	500	525	550	575	600	650	700	750	800	850	900	950	1000	
REAH10	●	○	●	○	○	○	●	/	/	/	/	/	/	/	/	/	/	/	/	/	/	/	/	/	/	/	/	
RE ₅ H15	●	○	○	○	○	○	○	○	○	○	○	○	○	○	○	○	○	○	○	○	○	○	○	○	○	○	○	○
REAH20	/	/	●	○	○	○	○	○	○	○	○	○	○	○	○	○	○	○	○	○	○	○	○	○	○	○	○	○
RE ₅ H25	/	/	●	○	○	○	○	○	○	○	○	○	○	○	○	○	○	○	○	○	○	○	○	○	○	○	○	○
RE ₅ HT25	/	/	●	○	○	○	○	○	○	○	○	○	○	○	○	○	○	○	○	○	○	○	○	○	○	○	○	○
RE ₅ HT32	/	/	●	○	○	○	○	○	○	○	○	○	○	○	○	○	○	○	○	○	○	○	○	○	○	○	○	○

●: Standard stroke
○: Strokes set for -XB10
/: No setting

Made to Order Common Specifications: -XB10A: Intermediate Stroke (Spacer-installed type)



6 Intermediate Stroke (Spacer-installed type)

Symbol
-XB10A

A spacer is installed on the exclusive body (● indication). The overall length is shorter than that of the spacer-installed type 1. The ⊙ indicates the selectable stroke range. (Strokes with the ● indication are not selectable.) The — indicates strokes supported by the spacer-installed type 1.

Bore size [mm]	Stroke range	Stroke													
		55	60	65	70	75	80	85	90	95					
32 to 100	51 to 94	⊙	●	⊙	●	⊙	●	—	●	⊙	●	⊙	●	⊙	●

Ordering example

Part no.	CQ2B50-57DZ-XB10A	
Description	<ul style="list-style-type: none"> ● Uses an exclusive tube (60 mm stroke) in "3". ● Makes 57 mm stroke with 3 mm spacer inside. ● The B dimension is 100.5 mm. B = 40.5 + 60 	

Specifications: Same as standard type

How to Order Q2 Standard model no. — XB10 A
 Intermediate stroke ●
 Spacer-installed type ●

Dimensions: CQ2 Series (Dimensions other than those below are the same as those of the standard type.)

Double acting,
Single rod

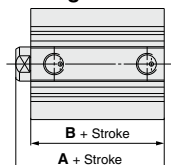

Symbol Stroke	A																B							
	51 to 54	56 to 59	61 to 64	66 to 69	76 to 79	81 to 84	86 to 89	91 to 94	51 to 54	56 to 59	61 to 64	66 to 69	76 to 79	81 to 84	86 to 89	91 to 94								
Bore size																	(mm)							
32	95	100	105	110	120	125	130	135	88	93	98	103	113	118	123	128								
40	101.5	106.5	111.5	116.5	126.5	131.5	136.5	141.5	94.5	99.5	104.5	109.5	119.5	124.5	129.5	134.5								
50	103.5	108.5	113.5	118.5	128.5	133.5	138.5	143.5	95.5	100.5	105.5	110.5	120.5	125.5	130.5	135.5								
63	109	114	119	124	134	139	144	149	101	106	111	116	126	131	136	141								
80	118.5	123.5	128.5	133.5	143.5	148.5	153.5	158.5	108.5	113.5	118.5	123.5	133.5	138.5	143.5	148.5								
100	130	135	140	145	155	160	165	170	118	123	128	133	143	148	153	158								

Made to Order Common Specifications: -XB11: Long Stroke Type



7 Long Stroke Type

Symbol
-XB11

Stroke which exceeds the standard stroke length

Applicable Series

Series	Description	Model	Type	Note	Vol. no. (for std model)
CX2	Slide unit	CX2	Slide bearing type		Web Catalog
CXW	Slide unit	CXWM	Slide bearing type		
		CXWL	Ball bushing bearing type		
CXSJ		CXSJ	Standard type	Except ø6, Axial type	
CXS	Dual rod cylinder	CXS ^{Note)}	Standard type		
		CXSW	Double rod type		
		CY3B-Z	Basic type		
CY	Magnetically coupled rodless cylinder	CY3B	Basic type		
		CY1H	Linear guide type		
		CY1F	Low profile guide type		
ML1	Hy-rodless cylinder	ML1C	Cam follower guide type		
REA	Sine rodless cylinder	REA	Basic type		
RSQ	Stopper cylinder/ Fixed mounting height	RSQ-Z	Double acting	Round bar type only	
		RSQ	Double acting	ø12, Round bar type only	

Note) The product with air cushion or with end lock for retraction side is available as a special order.

How to Order

Standard model no. **-XB11**

• Long stroke type

* Enter a symbol for stroke required.

Specifications: Same as standard type

* Refer to page 1459 for specifications and dimensions of the RSQ.

Stroke Range

Model	Bore size (mm)	Standard stroke (mm)	Long stroke (mm)	Model	Bore size (mm)	Standard stroke (mm)	Long stroke (mm)
CY3B (-Z)	25, 32	100 to 800	2001 to 3000 (ø25 to ø40)	CXSJ	10	10 to 75	80, 90, 100, 110, 120, 125, 150
	40, 50, 63	100 to 1000	2001 to 5000 (ø50, ø63)		15	10 to 100	110, 120, 125, 150
CY1H	10	100 to 300	301 to 500	CXS	20, 25, 32	10 to 100	110, 120, 125, 150, 175, 200
	15	100 to 500	501 to 750		10	10 to 75	80, 90, 100, 110, 120, 125, 150
	20	100 to 600	601 to 1000		15	10 to 100	110, 120, 125, 150
	25	100 to 800	801 to 1200		20, 25, 32	10 to 100	110, 120, 125, 150, 175, 200
CY1HT	25		1001 to 1200	CXSW	10, 15	10, 20, 30, 40, 50	75, 100, 125, 150
	32	100 to 1000	1001 to 1500		20, 25, 32	10, 20, 30, 40, 50, 75, 100	125, 150, 175, 200
CX2	15, 25	25 to 200	225, 250, 275, 300	ML1	25, 32, 40	100 to 1000	1001 to 2000
CXWM	16, 20, 25, 32	25 to 200	225, 250, 275, 300 (CXWM16 to 25)	REA	25, 32, 40, 50, 63	200 to 1000	2001 to 3000 (ø25, ø32, ø40) 2001 to 5000 (ø50, ø63)
CXWL			225, 250, 275 (CXWL16 to 25)	RSQ	12	10	15, 20
			225 (CXWL32)	RSQ-Z	16	10, 15	20, 30
					20, 32	10, 15, 20	30, 40
					40, 50	20, 25, 30	40, 50

Made to Order Common Specifications: -XB11: Long Stroke Type



7 Long Stroke Type

Symbol
-XB11

Dimensions

CX2 series: $\phi 15, \phi 25$

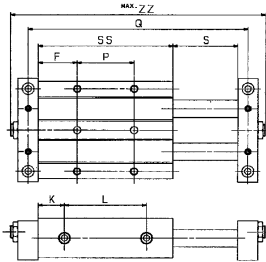

Model	F	L	K	P	Q	S	SS	Z	ZZ
CX2N15-225	89.5	238	15.5	90	506	227	269	496	528
CX2N15-250	102	263	15.5	90	556	252	294	546	578
CX2N15-275	114.5	288	15.5	90	606	277	319	596	628
CX2N15-300	127	313	15.5	90	656	302	344	646	678

Model	F	L	K	P	Q	S	SS	Z	ZZ
CX2N25-225	96	241	20.5	90	525	227	282	509	553
CX2N25-250	108.5	266	20.5	90	575	252	307	559	603
CX2N25-275	121	291	20.5	90	625	277	332	609	653
CX2N25-300	133.5	316	20.5	90	675	302	357	659	703

CXWM series: $\phi 16, \phi 25$

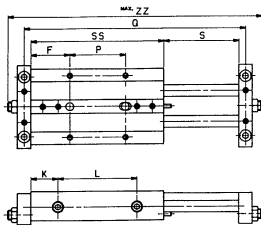

Model	F	L	K	P	Q	S	SS	Z	ZZ
CXWM16-225	92.5	238	18.5	90	514	227	275	502	538
CXWM16-250	105	263	18.5	90	564	252	300	552	588
CXWM16-275	117.5	288	18.5	90	614	277	325	602	638
CXWM16-300	130	313	18.5	90	664	302	350	652	688

Model	F	L	K	P	Q	S	SS	Z	ZZ
CXWM25-225	96	241	20.5	90	525	227	282	509	553
CXWM25-250	108.5	266	20.5	90	575	252	307	559	603
CXWM25-275	121	291	20.5	90	625	277	332	609	653
CXWM25-300	133.5	316	20.5	90	675	302	357	659	703

$\phi 20, \phi 32$

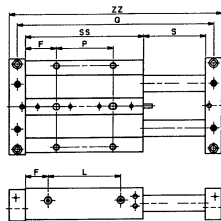

Model	F	L	K	P	Q	S	SS	Z	ZZ
CXWM20-225	94.5	239	20	90	520	227	279	506	534
CXWM20-250	107	264	20	90	570	252	304	556	584
CXWM20-275	119.5	289	20	90	620	277	329	606	634
CXWM20-300	132	314	20	90	670	302	354	656	684

Model	F	L	K	P	Q	S	SS	Z	ZZ
CXWM32-225	38	240	28	220	543	227	296	523	563
CXWM32-250	38	265	28	245	593	252	321	573	613

CXWL series: $\phi 16, \phi 25$

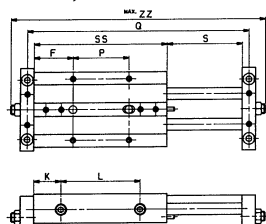

Model	F	L	K	P	Q	S	SS	Z	ZZ
CXWL16-225	115.5	239	41	90	560	227	321	548	584
CXWL16-250	128	264	41	90	610	252	346	598	634
CXWL16-275	140.5	289	41	90	660	277	371	648	684

Model	F	L	K	P	Q	S	SS	Z	ZZ
CXWL25-225	119	241	43.5	90	571	227	328	555	599
CXWL25-250	131.5	266	43.5	90	621	252	353	605	649
CXWL25-275	144	291	43.5	90	671	277	378	655	699

Made to Order Common Specifications: -XB11: Long Stroke Type



7 Long Stroke Type

Symbol
-XB11

Dimensions

CXWL series: $\varnothing 20$, $\varnothing 32$

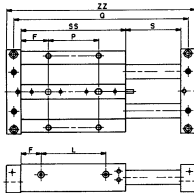

Model	F	L	K	P	Q	S	SS	Z	ZZ
CXWL20-225	116.5	239	42	90	564	227	323	550	578
CXWL20-250	129	264	42	90	614	252	348	600	628
CXWL20-275	141.5	289	42	90	664	277	373	650	678

Model	F	L	K	P	Q	S	SS	Z	ZZ
CXWL32-225	41	277	30	255	584	227	337	564	604

CXSJ_L^M series: $\varnothing 10$

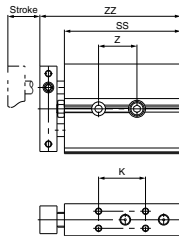

CXSJ_L^M series: $\varnothing 15$, $\varnothing 20$, $\varnothing 25$, $\varnothing 32$

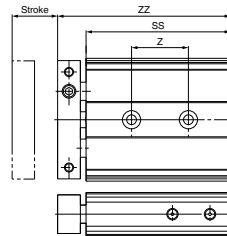

Model	CXSJ ^M $\varnothing 10$					CXSJ ^M $\varnothing 15$					CXSJ ^M $\varnothing 20$					CXSJ ^M $\varnothing 25$					CXSJ ^M $\varnothing 32$								
Stroke	80	90	100	110	120	125	150	110	120	125	150	110	120	125	150	175	200	110	120	125	150	175	200	110	120	125	150	175	200
SS	124.5	134.5	144.5	154.5	164.5	169.5	194.5	167.5	177.5	182.5	207.5	177.5	187.5	192.5	217.5	242.5	267.5	180.5	190.5	195.5	220.5	245.5	270.5	190.5	200.5	205.5	230.5	255.5	280.5
ZZ	136	146	156	166	176	181	206	180	190	195	220	194	204	209	234	259	284	197	207	212	237	262	287	210.5	220.5	225.5	250.5	275.5	300.5
Z	88	98	108	118	128	133	158	65	75			80	100					80	100					90					
K	92	102	112	122	132	137	162																						

Note 1) Dimensions of each model except SS, ZZ, Z and K on the above table are the same as standard type.

CXS_L^M series: $\varnothing 10$, $\varnothing 15$

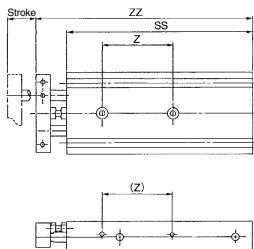

CXS_L^M series: $\varnothing 20$, $\varnothing 25$, $\varnothing 32$

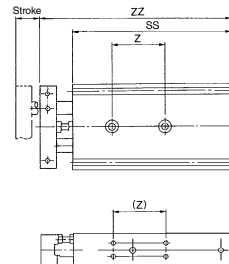

Model	CXS ^M $\varnothing 10$					CXS ^M $\varnothing 15$					CXS ^M $\varnothing 20$					CXS ^M $\varnothing 25$					CXS ^M $\varnothing 32$								
Stroke	80	90	100	110	120	125	150	110	120	125	150	110	120	125	150	175	200	110	120	125	150	175	200	110	120	125	150	175	200
SS	135	145	155	165	175	180	205	170	180	185	210	180	190	195	220	245	270	182	192	197	222	247	272	192	202	207	232	257	282
ZZ	152	162	172	182	192	197	222	189	199	204	229	204	214	219	244	269	294	206	216	221	246	271	296	222	232	237	262	287	312
Z	50	60				70	80	65	75			80						80						100					

Note 1) Dimensions of each model except SS, ZZ and Z on the above table are the same as standard type.
Note 2) For the external dimensions of the CXSW series double rod, refer to the standard type of CXSW.

Made to Order Common Specifications: -XB11: Long Stroke Type



7 Long Stroke Type

Symbol
-XB11

How to Order

For $\phi 12$

RS(D)Q Mounting bracket 12 - Stroke D - Auto switch Suffix -XB11
 • Refer to the below for specifications. • Long stroke type

For $\phi 16$ to $\phi 50$

RS(D)Q Mounting bracket Bore size - Stroke DZ - Auto switch Suffix -XB11
 • Refer to the below for specifications. • Long stroke type

Specifications

Applicable series	RSQ
Action	Double acting
Rod end configuration	Round bar type
Stroke range	See below.
Operating range	See below.
Specifications other than above	Same as standard type

Model	Bore size (mm)	Standard stroke (mm)	Long stroke (mm)
RSQ	12	10	15, 20
	16	10, 15	20, 30
RSQ-Z	20, 32	10, 15, 20	30, 40
	40, 50	20, 25, 30	40, 50

Operating range

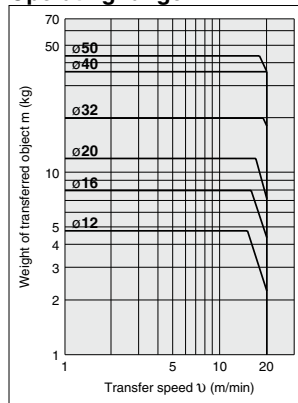

Dimensions (Dimensions other than below are the same as standard type.)

RS□QB12

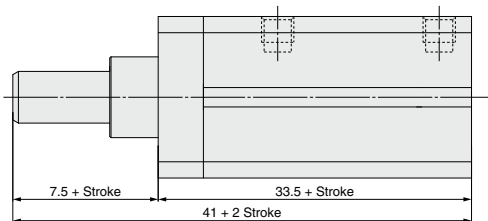

Made to Order Common Specifications: -XB12: External Stainless Steel Cylinder



8 External Stainless Steel Cylinder

Symbol
-XB12

A cylinder that uses stainless steel that excels in rust resistance for all external parts that are exposed to the surrounding environment. Its external dimensions and installation dimensions are identical to those of the standard CM2 series.

Applicable Series

Series	Description	Model	Action	Vol. no. (for std model)
CM2	Air cylinder	CM2	Double acting, Single rod Single acting (Spring return/extend)	Web Catalog
		CM2W	Double acting, Double rod	
	Non-rotating rod type	CM2K	Double acting, Single rod Single acting (Spring return/extend)	

How to Order

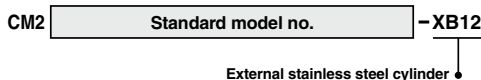

Specifications

Series	CM2, CM2K	CM2W
Material	The rod cover, head cover, cylinder tube, piston rod, mounting nut, rod end nut, seal retainer, and retaining ring are all made of stainless steel 304.	
Cushion	Rubber bumper (Standard equipment)	
Mounting type	Basic, Axial foot, Rod side flange, Head side flange, Integrated clevis, Boss-cut basic, Boss-cut rod side flange	Basic, Axial foot, Flange
Specifications other than above and external dimensions	Same as standard type	

Note) With air cushion, One-touch fitting integrated type are not available.

Mounting Bracket Part No.

Description	Bore size (mm)			
	20	25	32	40
Foot (2 foot brackets + 1 mounting nut)	CM-L020B-XB12	CM-L032B-XB12		CM-L040B-XB12
Foot (1 foot bracket)	CM-L020BSUS	CM-L032BSUS	CM-L040BSUS	
Flange	CM-F020BSUS	CM-F032BSUS	CM-F040BSUS	
Mounting nut	SN-020BSUS	SN-032BSUS	SN-040BSUS	
Rod end nut	NT-02SUS	NT-03SUS	NT-04SUS	
Single knuckle joint	I-020BSUS	I-032BSUS	I-040BSUS	
Double knuckle joint (1)	Y-020BSUS	Y-032BSUS	Y-040BSUS	
Pin for double knuckle joint (2)	CDP-1-XC27			CDP-3-XC27

Note 1) With pin, retaining ring

Note 2) With retaining ring (Cotter pins for bore size ø40)

Made to Order Common Specifications: -XB13: Low Speed Cylinder (5 to 50 mm/s)



9 Low Speed Cylinder (5 to 50 mm/s)

Symbol
-XB13

Even if driving at lower speeds 5 to 50 mm/s (CY: 7 to 50 mm/s), there would be no stick-slip phenomenon and it can run smoothly.

Applicable Series

Series	Description	Model	Action	Note	Vol. no. (for std model)
CJ2	Air cylinder	CJ2	Double acting, Single rod	ø6 only	Web Catalog
CG1	Air cylinder	CG1-Z	Double acting, Single rod	Except with rod boot and with air cushion	
	Direct mount type	CG1R-Z	Double acting, Single rod	Except with air cushion	
CU	Free mount cylinder	CU	Double acting, Single rod		
	Non-rotating rod type	CUK	Double acting, Single rod		
	Long stroke, standard type	CU	Double acting, Single rod		
	Long stroke, non-rotating rod type	CUK	Double acting, Single rod		
CQS	Compact cylinder	CQS	Double acting, Single rod	Except long stroke	
		CQSW	Double acting, Double rod		
CQ2	Compact cylinder	CQ2-Z	Double acting, Single rod	Except long stroke and large bore type	
		CQ2W-Z	Double acting, Double rod		
		CQP2	Double acting, Single rod		
CX2	Slide unit	CX2	Slide bearing type		
CXW	Slide unit	CXWM	Slide bearing type		
		CXWL	Ball bushing bearing type		
MXH	Compact slide	MXH-Z	Double acting, Single rod		
CXSJ	Dual rod cylinder	CXSJ	Standard type		
CXS		CXS	Standard type		
MGP	Compact guide cylinder	MGP-Z	Double acting		
	With end lock	MGP ^M _L	Double acting		
	Heavy duty guide rod type	MGPS	Double acting		
MGG	Guide cylinder	MGGM	Double acting	Shock absorber cannot be mounted.	
MGC	Guide cylinder	MGCM	Double acting	With rubber bumper. Port size Rc1/8 is applicable to ø20, 25.	
CY	Magnetically coupled rodless cylinder	CY3B-Z	Basic type		
		CY3B	Basic type		
		CY1S-Z	Slide bearing type		
		CY1L	Ball bushing bearing type		
CXT	Platform cylinder	CXT	Double acting	Except long stroke. Shock absorber cannot be mounted.	

How to Order

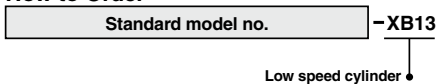

- Note 1) Operate without lubrication from a pneumatic system lubricator.
 Note 2) For the speed adjustment, use speed controllers for controlling at lower speeds. (AS-FM/AS-M series)

Specifications

Piston speed	5 to 50 mm/s (CY: 7 to 50 mm/s)
Dimensions	Same as standard type
Additional specifications	Same as standard type

Warning

Operating Precautions

Be aware that smoking cigarettes, etc. after your hands have come into contact with the grease used in this cylinder can create a gas that is hazardous to humans.

Made to Order Common Specifications: -XB14: Cylinder with Heat Resistant Auto Switch



10 Cylinder with Heat-resistant Auto Switch

Symbol
-XB14

A heat-resistant, compact cylinder which can mount a heat-resistant auto switch (Max. 150°C)

Applicable Series

Description	Model	Action	Note	Vol. no. (for std model)
Compact cylinder	CQ2	Double acting, Single rod	Applicable to ø16 to ø63 Excludes models with a rubber bumper Excludes the air-hydro type	Web Catalog

Specifications

Ambient and fluid temperature range	0 to 150°C
Seal material	Fluororubber
Grease	Heat-resistant grease
Min. stroke for auto switch mounting	15 (Same for both 1 pc. and 2 pcs.)
Specifications other than the above	Same as the standard type

For the detailed specifications of auto switches, refer to pages 1346 and 1347.

How to Order

Standard model no. - **M9NJL** - **XB14**

Symbol	Output
M9NJ	NPN
M9PJ	PNP
F7NJ	NPN

Number of auto switches

Cylinder with heat-resistant auto switch

* Lead wire length symbols
3 m L (Example) M9NJL
5 m Z (Example) M9NJZ

Auto Switch Proper Mounting Position (Detection at stroke end) and Mounting Height

D-M9□J

ø16 to ø25

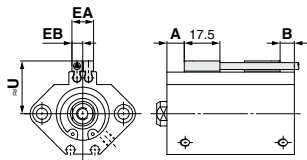

ø32 to ø63

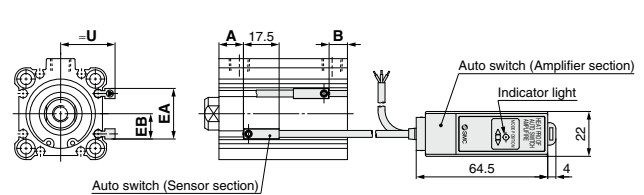

D-F7NJ

ø16 to ø25

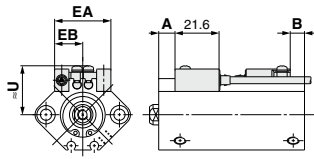

ø32 to ø63

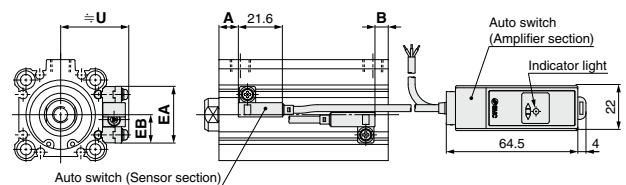

Auto switch model	D-M9□J								D-F7NJ							
	A	B	U	EA	EB	A	B	U	EA	EB	A	B	U	EA	EB	
16	9.5	7	21	11	5.5	8	5.5	22.5	28	14						
20	9.5	8.5	23.5	11	5.5	8	7	25.5	28	14						
25	9.5	9	27	11	5.5	8	7.5	28	28	14						
32	11	8	29	25	12.5	9.5	6.5	36	28	14						
40	15	10.5	31	30	15	13.5	9	38	33	16.5						
50	13	13.5	36	34	17	11.5	12	43.5	37	18.5						
63	15.5	16.5	41.5	43	21.5	14	15	48.5	46	23						

[mm]

Operating Range

[mm]

Auto switch model	Bore size							
	16	20	25	32	40	50	63	
D-M9□J	4.5	4.5	4.5	5	4.5	5	5	
D-F7NJ	4.5	4.5	4.5	5	4.5	5	5	

* Since the operating range is provided as a guideline at room temperature, it cannot be guaranteed. It may change substantially depending on the ambient environment.

Auto Switch Mounting Bracket Part Nos.

Auto switch model	Bore size [mm]							
	16	20	25	32	40	50	63	
D-F7NJ(L,Z)	BQ4-012				BQJ2-032			

Auto Switch Mounting Bracket Weight

Mounting bracket part no.	Weight [g]
BQ4-012	1.5
BQJ2-032	3.6

* Adjust the auto switch after confirming the operating conditions in the actual setting.

* The dimensions of the cylinder body are equivalent to those of the standard type, double acting, single rod of the CDQ2 series.

* Auto switches are shipped in the same package as the product but do not come assembled for protection purposes. Assemble them by referring to the A and B dimensions for mounting position shown above.

* The tightening torque for the auto switch mounting M2.5 screw is 0.25 to 0.35 N·m.

Made to Order Common Specifications: -XB19: High Speed Type



11 High Speed Type

Symbol
-XB19

This is a high speed type of the dual rod cylinder CXS series.

The cylinder speed can reach a maximum of 1500 mm/s (1000 mm/s for $\phi 25$ and $\phi 32$) by enlarging the orifice diameter of the cylinder port. The allowable kinetic energy is approximately four times that of the standard type.

Applicable Series

Series	Description	Model	Action	Vol. no. (for std model)
CXS	Dual rod cylinder	CXS	Double acting, Single rod	Web Catalog

Specifications

Bore size (mm)	6	10	15	20	25	32
Minimum operating pressure	0.15 MPa	0.1 MPa			0.05 MPa	
Maximum operating pressure	0.7 MPa					
Proof pressure	1.05 MPa					
Fluid	Air (Non-lube)					
Ambient and fluid temperature	-10 to 60°C (No freezing)					
Piston speed	30 to 1500 mm/s				30 to 1000 mm/s	
Port size	M5 x 0.8				F _c 1/8	
Stroke adjustable range	0 to -5 mm compared to the standard stroke					
Bearing type	Slide bearing, Ball bushing bearing					
Cushion	Rubber bumper					

How to Order

CXS Standard model no. -XB19
High speed type

Operating Conditions

Maximum Load Mass

When the cylinder is mounted as shown in the diagrams on the right, the maximum load mass (m) should not exceed the values indicated in the graph below.

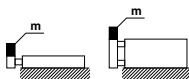

CXS □ 6, 10, 15, 20

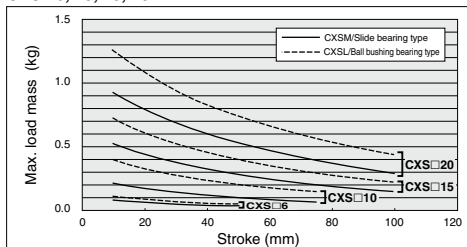

CXS □ 25, 32

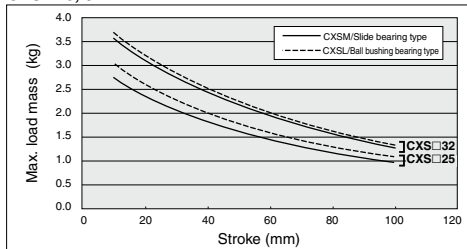

Allowable kinetic energy (XB19)

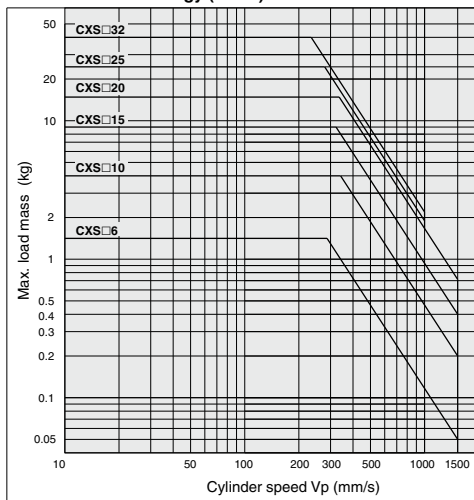

Dimensions

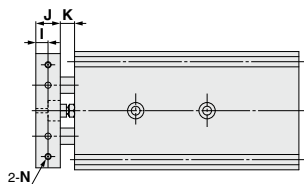

Bore size (mm)	I	J	K	N
6	3.25	6.5	7	M3 x 0.5 through-hole
10	5	10	7	M3 x 0.5 through-hole
15	6	12	7	M3 x 0.5 through-hole
20	7	14	10	M4 x 0.7 thread depth 6
25	7	14	10	M5 x 0.8 thread depth 7.5
32	9	18	12	M5 x 0.8 thread depth 8

Made to Order Common Specifications: -XB20: Stroke Adjustment Unit with Adjustment Bolt



12 Stroke Adjustment Unit with Adjustment Bolt

Symbol
-XB20

Stroke adjustment unit with an adjustment bolt.

Applicable Series

Series	Description	Model	Action	Vol. no. (for std model)
MY2	Mechanically jointed rodless cylinder	MY2H	Linear guide (Single axis)	Web Catalog
		MY2HT	Linear guide (Double axes)	

How to Order

MY2H
MY2HT Standard model no. -XB20

Stroke Adjustment Unit Specifications

Bore size (mm)		16		25		40	
Unit symbol		L	H	L	H	L	H
Shock absorber model	MY2H	RB0806	RB1007	RB1007	RB1412	RB1412	RB2015
	MY2HT	RB1007	RB1412	RB1412	RB2015	RB2015	RB2725
Stroke adjustment range by intermediate fixing spacer (mm)	Without spacer	0 to -5.6		0 to -11.5		0 to -16	
	With short spacer	-5.6 to -11.2		-11.5 to -23		-16 to -32	
	With long spacer	-11.2 to -16.8		-23 to -34.5		-32 to -48	

* Spacers are used to fix the stroke adjustment unit at an intermediate stroke position.
* Stroke adjustment range is applicable for one side when mounted on a cylinder.

Stroke adjustment unit mounting diagram

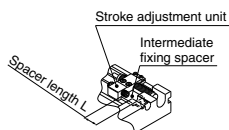

Example of L6L7 attachment

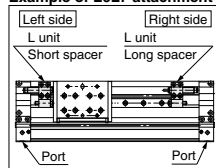

Stroke Adjustment Unit Model

Note) Stroke adjustment unit with adjusting bolt (-XB20) cannot be mounted on the standard cylinder.

Guide symbol • **MY2 H - A 25 L2 - 6N - XB20**

Symbol	Stroke adjustment unit	Mounting position
L1	L unit	For left
L2	L unit	For right
H1	H unit	For left
H2	H unit	For right

25 Cylinder bore size

16	16 mm
25	25 mm
40	40 mm

Unit part no. •

Symbol	Stroke adjustment unit
Nil	Without spacer
6	Short spacer
7	Long spacer

• Spacer shipping method

Nil	Assembled as a unit
N	Spacer only

* Spacers for MY2HT are shipped in 2 piece sets.

* Intermediate fixing spacers are shipped together.

MY2H (-XB20)

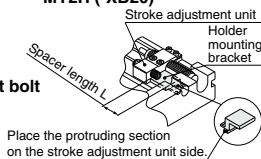

MY2HT (-XB20)

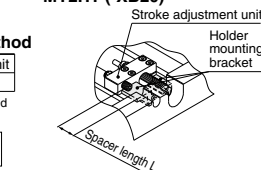

Components Parts

MY2H-A25L2-XB20 (Without spacer)

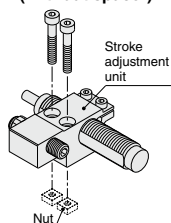

MY2H-A25L2-6-XB20 (With short spacer)

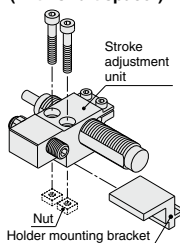

MY2H-A25L2-7-XB20 (With long spacer)

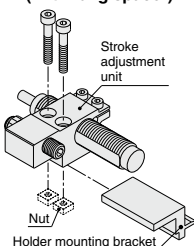

MY2H-A25L2-6N-XB20 (Short spacer only)

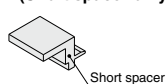

MY2H-A25L2-7N-XB20 (Long spacer only)

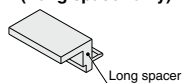

* Nuts are installed onto the cylinder body.

Made to Order Common Specifications: -XB20: Stroke Adjustment Unit with Adjustment Bolt



12 Stroke Adjustment Unit with Adjustment Bolt

Symbol
-XB20

Dimensions (Dimensions other than below are the same as standard type.)

MY2H L unit

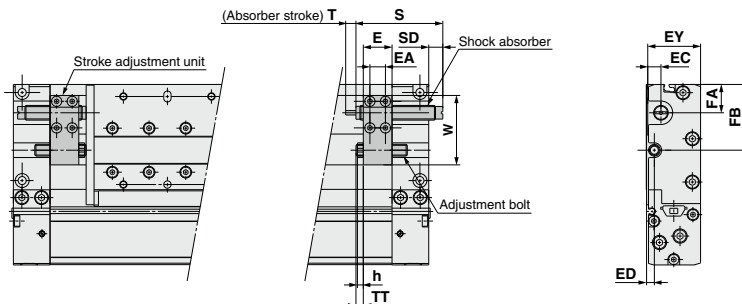

Applicable cylinder	E	EA	EC	ED	EY	FA	FB	h	S	T	SD	TT	W	Shock absorber model	Adjusting bolt	Adjustment range
MY2H16	15.8	8.4	6.2	5	28	12.4	30	3.2	40.8	6	1.3	4.2 (Max. 9.8)	34.5	RB0806	M5 x 0.8 x 25L	5.6
MY2H25	19.6	10.6	10	5.5	37	19.3	44.8	4	46.7	7	—	5 (Max. 16.5)	47.3	RB1007	M8 x 1.0 x 35L	11.5
MY2H40	29	16	13	8	57	17	49	5	67.3	12	—	6 (Max. 22)	59	RB1412	M10 x 1.0 x 50L	16

MY2H H unit

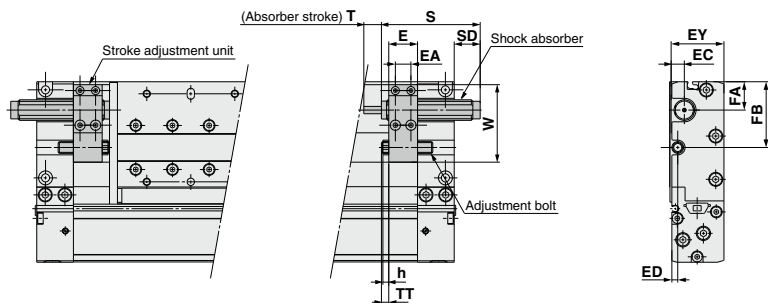

Applicable cylinder	E	EA	EC	ED	EY	FA	FB	h	S	SD	T	TT	W	Shock absorber model	Adjustment bolt	Adjustment range
MY2H16	15.8	8.4	6.2	5	28	12.4	30	3.2	46.7	7.2	7	4.2 (Max. 9.8)	35.5	RB1007	M5 x 0.8 x 25L	5.6
MY2H25	19.6	10.6	10	5.5	37	19.3	44.8	4	67.3	18.2	12	5 (Max. 16.5)	52.8	RB1412	M8 x 1.0 x 35L	11.5
MY2H40	29	16	13	8	57	17	49	5	73.2	—	15	6 (Max. 22)	59	RB2015	M10 x 1.0 x 50L	16



⚠ Caution

Since the dimension **EY** of the unit is greater than the table top height (dimension **H**), when a workpiece is loaded that is larger than the full length (dimension **L**) of the slide table, allow a clearance of size "a" or larger at the workpiece side.

Applicable cylinder	a	EY	H
MY2H16 L/H Unit	1	28	28
MY2H25 L/H Unit	1	37	37
MY2H40 L/H Unit	0	57	58

Made to Order Common Specifications: -XB20: Stroke Adjustment Unit with Adjustment Bolt



12 Stroke Adjustment Unit with Adjustment Bolt

Symbol
-XB20

Dimensions (Dimensions other than below are the same as standard type.)

MY2HT L unit

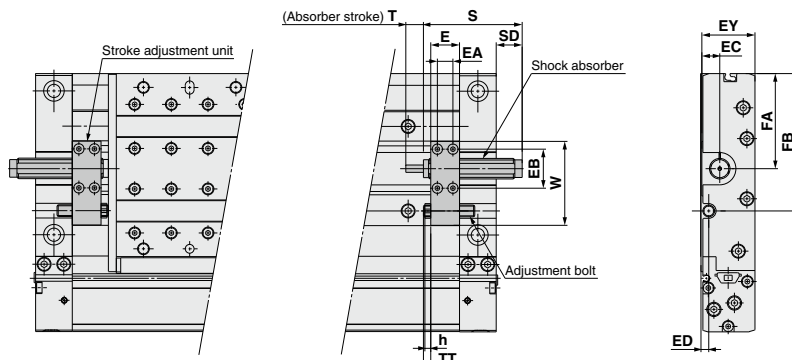

Applicable cylinder	E	EA	EB	EC	ED	EY	FA	FB	h	S	SD	T	TT	W	Shock absorber model	Adjustment bolt	Adjustment range
MY2HT16	15.8	8.4	21	9	5	28	46.5	67	3.2	46.7	7.2	7	4.2 (Max. 9.8)	40.6	RB1007	M5 x 0.8 x 25L	5.6
MY2HT25	19.6	10.6	26.6	12.2	5.5	37	64.8	93.6	4	67.3	18.2	12	5 (Max. 16.5)	57.2	RB1412	M8 x 1.0 x 35L	11.5
MY2HT40	29	16	37	18.2	8	58	74.5	110.5	5	73.2	—	15	6 (Max. 22)	71.6	RB2015	M10 x 1.0 x 50L	16

MY2HT H unit

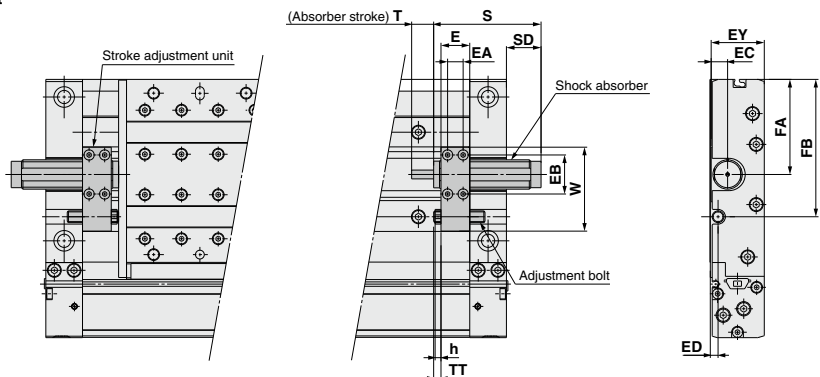

Applicable cylinder	E	EA	EB	EC	ED	EY	FA	FB	h	S	SD	T	TT	W	Shock absorber model	Adjustment bolt	Adjustment range
MY2HT16	15.8	8.4	21	9	5	28	46.5	67	3.2	67.3	27.8	12	4.2 (Max. 9.8)	40.6	RB1412	M5 x 0.8 x 25L	5.6
MY2HT25	19.6	10.6	26.6	12.2	5.5	37	64.8	93.6	4	73.2	24.1	15	5 (Max. 16.5)	57.2	RB2015	M8 x 1.0 x 35L	11.5
MY2HT40	29	16	37	18.2	8	58	74.5	110.5	5	99	24.5	25	6 (Max. 22)	71.6	RB2725	M10 x 1.0 x 50L	16

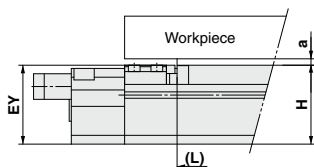

⚠ Caution

Since the dimension **EY** of the unit is greater than the table top height (dimension **H**), when a workpiece is loaded that is larger than the full length (dimension **L**) of the side table, allow a clearance of size "a" or larger at the workpiece side.

Applicable cylinder	a	EY	H
MY2HT16 L/H Unit	1	28	28
MY2HT25 L/H Unit	1	37	37
MY2HT40 L/H Unit	1	58	58

Made to Order Common Specifications: -XB20: Stroke Adjustment Unit with Adjustment Bolt



12 Stroke Adjustment Unit with Adjustment Bolt

Symbol
-XB20

XB20 (Stroke Adjustment Unit with Adjustment Bolt)

⚠ Caution

<Stroke adjustment with adjusting bolt>

1. Loosen the lock nut for the adjustment bolt and adjust a stroke by rotating the adjustment bolt.

After adjusting the stroke, secure the adjustment bolt by tightening the lock nut.

If the effective stroke of the shock absorber is shortened by the stroke adjustment, its absorption capacity will be drastically reduced. Therefore, the adjustment bolt should be secured at a position where it projects about 0.5 mm farther than the shock absorber.

Tighten shock absorber holding bolts equally with the specified tightening torque.

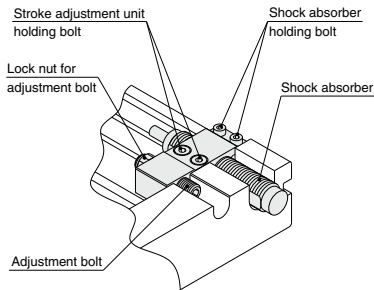

MY2H(-XB20)

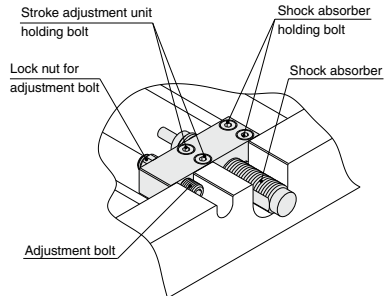

MY2HT(-XB20)

Tightening Torque for Stroke Adjustment Unit Holding Bolt

(N·m)

Bore size (mm)	MY2H		MY2HT	
	L unit	H unit	L unit	H unit
16		0.6		
25		1.5		
40		5.0		

Tightening Torque for Shock Absorber Holding Bolt

(N·m)

Bore size (mm)	MY2H		MY2HT	
	L unit	H unit	L unit	H unit
16		0.6		
25	1.5	0.6		1.5
40	5.0	1.5		5.0

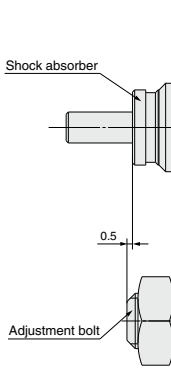

2. Do not use the shock absorber and air cushion together.

Made to Order Common Specifications: -XB22: Shock Absorber Soft Type RJ Series Type



13 Shock Absorber Soft Type RJ Series Type

Symbol
-XB22

- The standard cylinder has been equipped with shock absorber soft type RJ series type to enable soft stopping at the stroke end.
- Two different shock absorbers are available in accordance with the operating conditions.

Applicable Series

Series	Description	Model	Bearing type	Applicable bore size	Vol. no. (for std model)
MY	Mechanically jointed rodless cylinder	MY1B	Basic type	ø10, ø20 to ø40	Web Catalog
		MY1M	Slide bearing type	ø16 to ø40	
		MY1C	Cam follower type	ø16 to ø40	
		MY1H	Single-axis linear guide type	ø10 to ø40	
		MY1□W	With protective cover	ø16 to ø40	
		MY2C	Cam follower type	ø16, ø25, ø40	
		MY2H	Single-axis linear guide type	ø16, ø25, ø40	
		MY2HT	Double-axis linear guide type	ø16, ø25	
		MY3B	Basic type	ø16 to ø50	
		MY3M	Slide bearing type	ø16, ø25, ø40	
CY	Magnetically coupled rodless cylinder	CY1L	Ball bushing bearing type	ø6 to ø25	Web Catalog
		CY1H	Single-axis linear guide type	ø10 to ø25	
		CY1HT	Double-axis linear guide type	ø25	
MGP	Compact guide cylinder	MGP-Z	Slide bearing type, Ball bushing bearing type	ø12 to ø100	Web Catalog
MGG	Guide cylinder	MGG	Slide bearing type, Ball bushing bearing type	ø20 to ø32	
CX2	Slide unit	CX2N	Slide bearing type	ø10, ø15, ø25	
CXT	Platform cylinder	CXT	Slide bearing type, Ball bushing bearing type	ø12 to ø25	

How to Order

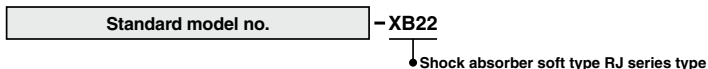

How to Order a Stroke Adjustment Unit for MY Itself

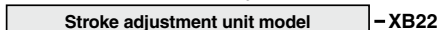

Specifications

Absorbed energy	For the maximum impact weight graph, refer to page 1470.
Specifications other than above and external dimensions	Same as standard type

* For dimensions of the MGP series, refer to page 1471.

- * For details on shock absorber soft type RJ series, refer to the **Web Catalog**.
- * The shock absorber service life is different from that of each cylinder. Refer to the “Specific Product Precautions” of the RJ series for the replacement period.

Made to Order Common Specifications: -XB22: Shock Absorber Soft Type RJ Series Type



13 Shock Absorber Soft Type RJ Series Type

Symbol
-XB22

Cylinders

Note) Refer to the **Web Catalog** for the details of the shock absorber RB series.

Mechanically Jointed Rodless Cylinder

Model	Type	Stroke adjusting unit	Bore size						
			ø10	ø16	ø20	ø25	ø32	ø40	ø50
MY1B	-XB22	L			RJ0806H	RJ1007H		RJ1412H	
		H	RJ0805		RJ1007H	RJ1412H			
	Standard	L			RB0806	RB1007		RB1412	
		H	RB0805		RB1007	RB1412		RB2015	
MY1M MY1C	-XB22	L			RJ0806H	RJ1007H		RJ1412H	
		H			RJ1007H	RJ1412H			
	Standard	L			RB0806	RB1007		RB1412	
		H			RB1007	RB1412		RB2015	
MY1H	-XB22	L			RJ0806H	RJ1007H		RJ1412H	
		H	RJ0805		RJ1007H	RJ1412H			
	Standard	L			RB0806	RB1007		RB1412	
		H	RB0805		RB1007	RB1412		RB2015	
MY1□W	-XB22	L			RJ0806H	RJ1007H		RJ1412H	
	Standard	L			RB0806	RB1007		RB1412	
MY2C MY2H	-XB22	L			RJ0806H	RJ1007H		RJ1412H	
		H			RJ1007H (Note)	RJ1412H			
	Standard	L			RB0806	RB1007		RB1412	
		H			RB1007 (Note)	RB1412		RB2015	
MY2HT	-XB22	L			RJ1007H		RJ1412H		
		H			RJ1412H				
	Standard	L			RB1007		RB1412		
		H			RB1412		RB2015		
MY3B	-XB22	L			RJ0806H		RJ1007H		RJ1412H
		H			RJ1007H		RJ1412H		
	Standard	L			RB0806		RB1007		RB1412
		H			RB1007		RB1412		RB2015
MY3M	-XB22	L			RJ0806H		RJ1007H		RJ1412H
		H			RJ1007H		RJ1412H		
	Standard	L			RB0806		RB1007		RB1412
		H			RB1007		RB1412		RB2015

Note) MY2C16 is not available with H unit.

Magnetically Coupled Rodless Cylinder

Model	Type	Bore size				
		ø6	ø10	ø15	ø20	ø25
CY1L	-XB22	RJ0805		RJ0806H	RJ1007H	RJ1412H
	Standard		RB0805		RB1006	RB1411
CY1H	-XB22			RJ0806H	RJ1007H	RJ1412H
	Standard		RB0805	RB0806	RB1006	RB1411
CY1HT	-XB22					RJ1412H
	Standard					RB1411

Guide Cylinder

Model	Type	Bore size											
		ø12	ø16	ø20	ø25	ø32	ø40	ø50	ø63	ø80	ø100		
MGP-Z	-XB22		RJ0806H		RJ1007H		RJ1412H				RJ2015H		RJ2725H
	-XC69										RB2015		RB2725
MGG	-XB22			RJ1007H		RJ1412H							
	Standard			RB1007		RB1412					RB2015		RB2725

Platform Cylinder

Model	Type	Bore size				
		ø12	ø16	ø20	ø25	
CXT	-XB22		RJ0806H		RJ1007H	RJ1412H
	Standard		RB0806		RB1007	RB1411

Slide Unit/Double Rod Type

Model	Type	Bore size		
		ø10	ø15	ø25
CX2N	-XB22		RJ0806H	RJ1007H
	Standard		RB0805	RB1006

Made to Order Common Specifications: -XB22: Shock Absorber Soft Type RJ Series Type



13 Shock Absorber Soft Type RJ Series Type

Symbol
-XB22

Maximum Impact Weight Graph (Shock Absorber Performance Line Graph) * Values in the maximum impact mass graph are at room temperature (20 to 25°C).

Ensure that the impact mass and the impact speed are within the absorbed energy graphs below.

Refer to each cylinder selection calculation for load factors and guide load factors.

Please consult with SMC for the MY3 series since there are restrictions on collision speed resulting from the cylinder.

■ Type of collision

Horizontally-applied impact

Air cylinder impact (horizontal/upward)

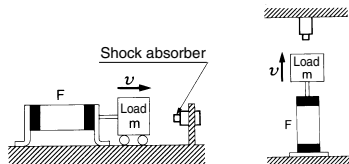

Air cylinder impact (downward)

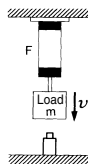

RJ0805 Absorbed Energy

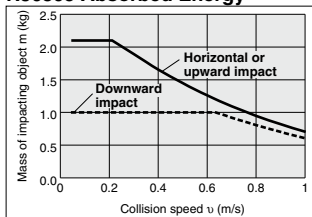

RJ0806H Absorbed Energy

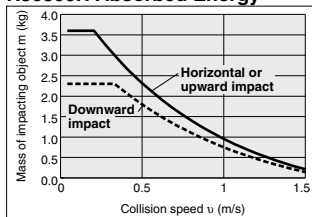

RJ1007H Absorbed Energy

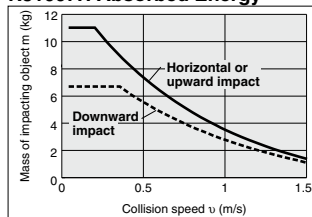

RJ1412H Absorbed Energy

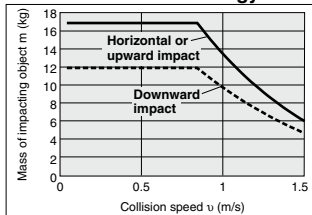

RJ2015H Absorbed Energy

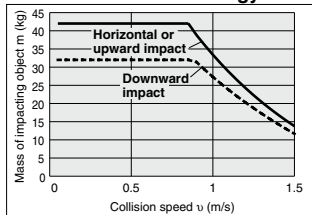

RJ2725H Absorbed Energy

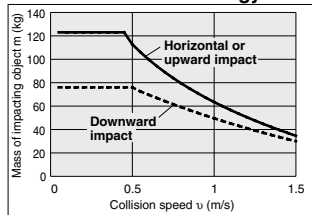

* Be sure to read "Handling Precautions for SMC Products" ([Web Catalog](#)) and "Shock Absorber Soft Type RJ Series" ([Web Catalog](#)) before using.

Made to Order Common Specifications: -XB22: Shock Absorber Soft Type RJ Series Type



13 Shock Absorber Soft Type RJ Series Type

Symbol
-XB22

Dimensions (Dimensions other than below are the same as standard type.)

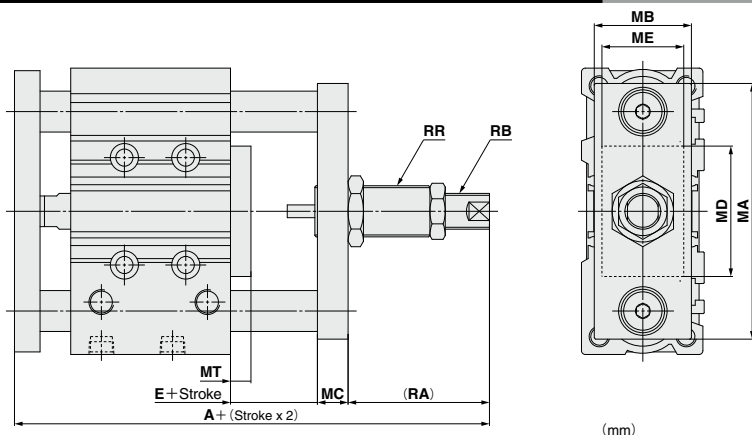

Bore size	A	E	MA	MB	MC	MD	ME	MT	RA	RB	RR
12	90	7	51	19	8	27	13	6	33	RJ0806H	M12 x 1.5
16	94	7	58	19	8	28	16	6	33	RJ0806H	M12 x 1.5
20	109	9	68	30	10	33	22	8	37	RJ1007H	M14 x 1.5
25	109.5	9	82	30	10	41	25	8	37	RJ1007H	M14 x 1.5
32	135.5	9	100	38	12	51	32	8	55	RJ1412H	M20 x 1.5
40	142	9	108	38	12	60	32	8	55	RJ1412H	M20 x 1.5
50	155	10	139	60	16	71	38	9	57	RJ2015H	M27 x 1.5
63	160	10	153	60	16	84	50	9	57	RJ2015H	M27 x 1.5
80	212.5	17	190	75	22	114	50	16	77	RJ2725H	M36 x 1.5
100	232	17	228	75	25	140	65	16	74	RJ2725H	M36 x 1.5

Specifications of Extension Adjusting Mechanism

Bore size (mm)	12, 16	20, 25	32, 40	50, 63	80, 100
Shock absorber model	RJ08006H	RJ1007H	RJ1412H	RJ2015H	RJ2725H
Stroke adjustment range [mm]	0 to -15		0 to -25		0 to -30

Mounting

Do not allow hands or fingers near the cylinder during its operation.

If finger, etc. were to get caught between shock absorber and body, it might damage on the human body and the peripheral equipment. Take protective measures by mounting a protective cover, etc. as necessary.

Basically, avoid bottom-mounting a cylinder.

Mounting space is limited owing to the guide rod and the end plate, etc. Mount a cylinder by the top mounting or side mounting.

Adjustment

1. How to adjust an adjustment screw (Stroke adjustment)

Loosen only the hexagon nut 1, then turn the adjustment screw to adjust the stroke. After adjusting, lock it with the hexagon nut 1. Fix it at the position ejected from the end plate, so that the end face of an adjustment screw could hit the bracket for stopper directly. (Refer to the figure right above.)

2. How to replace shock absorbers

Loosen hexagon nut 2, and turn a shock absorber counterclockwise for removal. For installing a new shock absorber, fix it at the position that the end face of an adjustment screw sticks out by 0.5 mm from a shock absorber. (Refer to the figure on the right.) After adjusting the position of shock absorber, be sure to secure with hexagon nut 2.

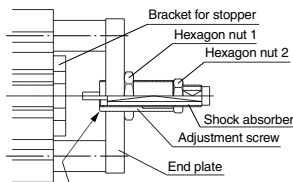

* Adjust it so that the end of an adjustment screw hit directly on the stopper bracket.

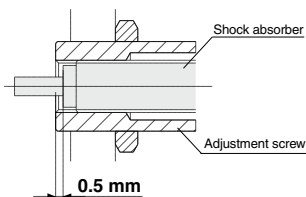

Made to Order Common Specifications: -XC2(A): Rod End Length Extended 10 mm



14 Rod End Length Extended 10 mm

Symbol

-XC2(A)

-XC2 Rod end length (L dimension) specifications of the cylinder for mounting the flange on the foot or rod side are "standard product + 10 mm" (-XC2).

Applicable Series

Series	Description	Model	Action	Note	Vol. no. (for std model)
CQ2	Standard type	CQ2-Z	Double acting, Single rod	Foot type, Rod side flange only	Web Catalog
		CQ2-Z	Single acting (Spring return/extend)	Foot type, Rod side flange	
		CQ2W-Z	Double acting, Double rod	Foot type only	
	Non-rotating rod type	CQ2K-Z	Double acting, Single rod	Foot type, Rod side flange only	
		CQ2KW-Z	Double acting, Double rod	Foot type only	
		CQ2□IS-Z	Double acting, Single rod	Foot type, Rod side flange	

-XC2A Rod end length (L dimension) specifications of the cylinder for mounting the double rod flange are "standard product + 10 mm" (-XC2A).

Applicable Series

Series	Description	Model	Action	Note	Vol. no. (for std model)
CQ2	Standard type	CQ2W-Z	Double acting, Double rod	Flange only	Web Catalog
	Non-rotating rod type	CQ2KW-Z	Double acting, Double rod	Flange only	

How to Order

C(D)Q2A Standard model no. - **XC2 (A)**

● Rod end length extended 10 mm

Specifications: Same as standard type

-XC2	Foot type, Rod side flange only
-XC2A	For mounting double rod flange

Dimensions (Dimensions other than below are the same as standard type.)

Double acting, Single rod Double acting, Double rod (-XC2) Double acting, Double rod (-XC2A)

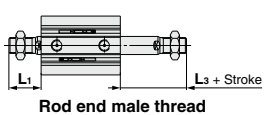
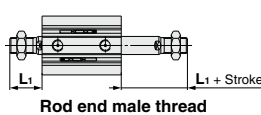
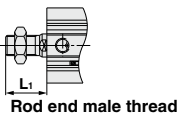
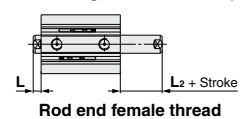
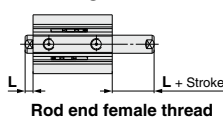
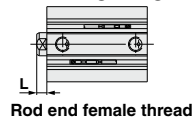

XC2: Standard, Anti-lateral load, Non-rotating rod (mm)

Bore size (mm)	Applicable series		Dimensions		
	Standard type	Non-rotating rod type	Female thread		Male thread
			L	L1	L1
12	○	—	13.5	24	
16	○	—	13.5	25.5	
20	○	—	14.5	28.5	
25	○	—	15	32.5	
32	○	—	17	38.5	
40	○	○	17	38.5	
50	○	○	18	43.5	
63	○	○	18	43.5	
80	○	—	20	53.5	
100	○	—	22	53.5	

XC2A: Standard, Non-rotating rod (mm)

Bore size (mm)	Applicable series		Dimensions					
	Standard type	Non-rotating rod type	Female thread			Male thread		
			L	L2	L1	L1	L3	
12	○	—	13.5	3.5	24	14		
16	○	—	13.5	3.5	25.5	15.5		
20	○	—	14.5	4.5	28.5	18.5		
25	○	—	15	5	32.5	22.5		
32	○	—	17	7	38.5	28.5		
40	○	○	17	7	38.5	28.5		
50	○	○	18	8	43.5	33.5		
63	○	○	18	8	43.5	33.5		
80	○	—	20	10	53.5	43.5		
100	○	—	22	12	53.5	43.5		

XC2: CQ2 Single acting

Bore size	End shape	Action	Stroke	Female thread						Male thread					
				L						L1					
				Spring return			Spring extend			Spring return			Spring extend		
				All strokes	5	10	20	All strokes	5	10	20				
12				13.5	18.5	23.5	—	24	29	34	—				
16				13.5	18.5	23.5	—	25.5	30.5	35.5	—				
20				14.5	19.5	24.5	—	28.5	33.5	38.5	—				
25				15	20	25	—	32.5	37.5	42.5	—				
32				17	22	27	—	38.5	43.5	48.5	—				
40				17	22	27	—	38.5	43.5	48.5	—				
50				18	—	28	38	43.5	—	53.5	63.5				

Made to Order Common Specifications: -XC3: Special Port Location



15 Special Port Location

Symbol
-XC3

Compared with the standard type, a cylinder which changes the connection port location of rod/head cover and the location of cushion valve.

Applicable Series

Series	Description	Model	Action	Note	Vol. no. (for std model)
CJ2	Standard type	CJ2-Z	Double acting, Single rod	Except w/ rail mounting type auto switches, w/ air cushion	
	Non-rotating rod type	CJ2K-Z	Double acting, Single rod		
	Smooth cylinder	CJ2Y-Z	Double acting, Single rod	Except w/ rail mounting type auto switches	
CM2	Air cylinder	CM2-Z1	Double acting, Single rod		
	Standard type	CM2-Z	Double acting, Single rod		
		CM2W-Z	Double acting, Double rod		
	Air-hydro type	CM2H-Z	Double acting, Single rod		
		CM2K-Z	Double acting, Single rod		
	Non-rotating rod type	CM2K-Z	Double acting, Single rod		
		CM2KW-Z	Double acting, Double rod		
	Direct mount type	CM2R-Z	Double acting, Single rod		Except with air cushion
	Direct mount type, Air-hydro type	CM2HR-Z	Double acting, Single rod		
	Non-rotating rod, Direct mount type	CM2RK-Z	Double acting, Single rod		
	Smooth cylinder	CM2Y-Z	Double acting, Single rod		
	End lock cylinder	CBM2	Double acting, Single rod		Except with air cushion
Low speed cylinder	CM2X-Z	Double acting, Single rod			
CG1	Air cylinder	CG1-Z1	Double acting, Single rod		
MB	Standard type	MB	Double acting, Single rod		
		MBW	Double acting, Double rod		
	Non-rotating rod type	MBK	Double acting, Single rod		
		MBKW	Double acting, Double rod		
MB1	Standard type	MB1	Double acting, Single rod		Web Catalog
	Non-rotating rod type	MB1W	Double acting, Double rod		
		MB1K	Double acting, Single rod		
CA2	Standard type	CA2	Double acting, Single rod		
	End lock cylinder	CBA2	Double acting, Single rod		
CS1	Standard type	CS1	Double acting, Single rod		
	Low friction type	CS1□Q	Double acting, Single rod	Applicable to ø125 to ø160	
CS2	Standard type	CS2	Double acting, Single rod		
	Smooth cylinder	CS2Y	Double acting, Single rod	Applicable to ø125 to ø160	
RHC	High power cylinder	RHC	Double acting, Single rod	Applicable to ø20 to ø40	
RSQ	Stopper cylinder	RSQ-Z	Double acting with spring installed		
			Single acting		
		RSQ*	Double acting		ø12 only
			Double acting with spring installed		ø12 only
		Single acting		ø12 only	
		Double acting			
RSG	Stopper cylinder	RSG	Double acting with spring installed		
			Single acting		
CL1	Locked up cylinder	CL1	Double acting, Single rod		
CLS	Cylinder with lock	CLS	Double acting, Single rod		
CNA2	Cylinder with lock	CNA2	Double acting, Single rod	Unlocking cams are on the same side as cushion valves.	
MXH	Compact slide	MXH-Z	Double acting		

* The RSQ, MB, MB1, and CA2 are the same shape as the current product.

How to Order

CJ2
CM2

Standard model no. -XC3 A B

Special port location

Head port location seen from the rod side

Rod port location seen from the rod side

Specifications: Same as standard type.

* For port location, refer to the following diagrams and show the symbols of A, B, C, and D.

Port Location

Series	Corresponding symbol of mounting bracket (Positional relationships)	
CJ2	<p>Position relation between clevis and port</p> <p>* Viewed from the rod side, the ports are rendered A, B, C, and D, in the clockwise direction.</p>	<p>* Viewed from the rod side, with the clevis positioned as shown in the diagram, the ports are rendered A, B, C, and D, in the clockwise direction.</p>
CM2		
CG1		

1. Positional relationships between port and cushion valve cannot be changed.
3. The standard product is used for CG1-XC3AA/BB/CC/DD.

2. Cylinder with cushion of CJ2 (CJ2-A) is not available for -XC3.

Made to Order Common Specifications: -XC3: Special Port Location



15 Special Port Location

Symbol
-XC3

How to Order

MB, MB1, CA2, CS1, CS2, CNA2, CL1

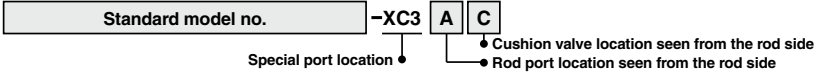

RSQ-Z, RSQ, RSG

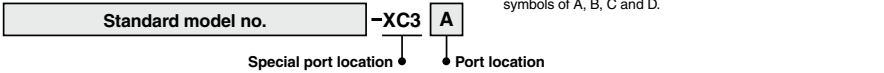

Specifications: Same as standard type

Relation between Port Location and Cushion Valve Location

Series	Corresponding symbol of mounting bracket (Positional relationships)						
CA2 CS1 CNA2 CL1	<p>Basic type</p>	<p>Foot type</p>	<p>Rod side flange type</p>	<p>Head side flange type</p>	<p>Single clevis type</p>	<p>Double clevis type</p>	<p>Center trunnion type</p>
CS2	<p>Cushion valve</p>	<p>Port</p>	<p>Cushion valve</p>	<p>Port</p>	<p>Cushion valve</p>	<p>Port</p>	<p>Cushion valve</p>
MB MB1	<p>Basic type</p>	<p>Foot type</p>	<p>Rod side flange type</p>	<p>Head side flange type</p>	<p>Single clevis type</p>	<p>Double clevis type</p>	<p>Center trunnion type (Except MB1)</p>
RSQ-Z RSQ RSG	<p>In the case of standard type, the symbol for port and rod-chamfered positions are on the same surface and positioned upward. Define the port position at right to be A, and then B, C in a clockwise order.</p> <p>Standard type</p> <p>-XC3A</p> <p>-XC3B</p> <p>-XC3C</p>						

Made to Order Common Specifications: -XC3: Special Port Location



15 Special Port Location

Symbol
-XC3

How to Order

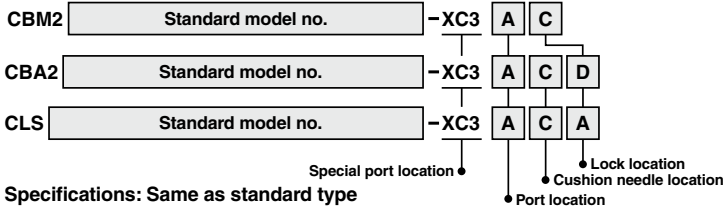

Specifications: Same as standard type

Relation between Port Location and Cushion Valve Location

Series	Corresponding symbol of mounting bracket (Positional relationships)	
CBM2	<p>The port and end lock positions can be specified. Rod side port and head side port are at the same location. Symbols of lock position and port location are as the following diagrams.</p> <p>Standard (AD) AC AB</p> <p>Except with air cushion</p>	<p>The figures below show typical symbol examples for the double clevis type.</p> <p>AD CD BD Standard (BA) CA DA</p> <p>Diagrams seen from the rod side</p>
CBA2	<p>Port and cushion needle are at the same rod/head position. Symbols of port location, cushion needle position and lock position are as the following diagrams.</p> <p>Standard (ABD) ACD ADB</p> <p>End lock Cushion valve</p>	<p>When the mounting bracket is attached, the conditions placed like below are on a basis.</p> <p>Foot type (A) Rod side flange type (A) Head side flange type (A) Single clevis type (A) Double clevis type (A) Center trunnion type (A)</p> <p>Diagrams seen from the rod side</p>
CLS	<p>Basic type Foot type Rod side flange type Head side flange type Single clevis type Double clevis type Center trunnion type</p> <p>Lock location Port Cushion valve</p>	<p>1. Symbols of port and cushion valve, and lock positions, have to be looked at from the rod side as shown in the figures above. Define the upper side to be A, and then B, C, and D in a clockwise order.</p> <p>2. The combination model of a port and a cushion valve is applicable when the rod and head covers are moved to the same position.</p> <p>3. Part number of -XC3[A][B][A] is not available since it indicates a standard type.</p> <p>4. For the rod side flange type, lock positions [B] and [D] cannot be manufactured since the brake cylinder and the mounting hole of the flange bracket interfere with each other.</p> <p>5. Symbols excluding those that indicate the locations of ports and cushion valves are the same as the standard type.</p>

Made to Order Common Specifications: -XC3: Special Port Location



15 Special Port Location

Symbol
-XC3

How to Order

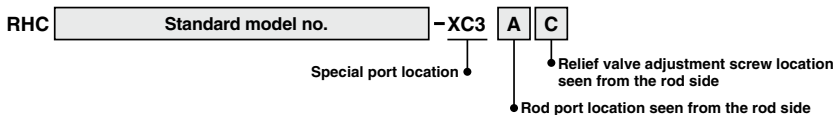

* For port location, refer to the following diagrams and show the symbols of A, B, C and D.

Specifications: Same as standard type

Relation between Port Location and Relief Valve Adjustment Screw Location

Series	Corresponding symbol of mounting bracket (Positional relationships)			
RHC	<p>Basic type</p>	<p>Foot type</p>	<p>Rod side flange type</p>	<p>Head side flange type</p>
	<p>Relief valve adjustment screw</p> <p>① As shown in the above diagram, the symbols for the positions of the ports and the relief valve adjustment screws are as follows: viewed from the rod side, the top position is rendered A, then B, C and D in the clockwise direction. ② The type in which the ports and the relief valve adjustment screws is applicable only when the rod cover and the head cover are changed to the same positions. ③ The symbol indicated as "-XC3 <input type="text" value="A"/> <input type="text" value="B"/>" is the standard specification, and there are no part numbers A or B. ④ Those shown above are the same as standard, other than the symbols that indicate the positions of the ports and the relief valve adjustment screws. ⑤ Brackets are shipped together.</p>			

How to Order

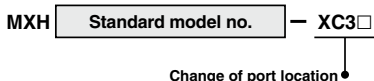

Specifications: Same as standard type

The port location of a standard product is in the axial direction, and it is shipped as plugged on both sides. However, side ported types can be ordered. A shifting of the plugs is not required by the customer.

Relation between Port Location and Plug Location

Standard	-XC3A	-XC3B

Made to Order Common Specifications: -XC4: With Heavy Duty Scraper



16 With Heavy Duty Scraper

Symbol
-XC4

Cylinders with a heavy duty scraper on the wiper ring are suitable for use in extremely dusty environments and those where they will be exposed to earth or sand, such as in die-casted equipment, construction machinery, and industrial vehicles.

Applicable Series

Series	Description	Model	Action	Note	Vol. no. (for std model)
CM2	Air cylinder	CM2-Z	Double acting, Single rod		
		CM2W-Z	Double acting, Double rod		
	Centralized piping type	CM2□□P	Double acting, Single rod		
	End lock cylinder	CBM2	Double acting, Single rod	Head side locking type only (Except w/ air cushion)	
CG1	Air cylinder	CG1-Z1	Double acting, Single rod	Applicable to ø32 to ø63	
		CG1-Z	Double acting, Single rod	Applicable to ø32 to ø63	
MB	Air cylinder	MB-Z	Double acting, Single rod	Except ø125	
		MBW-Z	Double acting, Double rod	Except ø125	
MB1	Air cylinder	MB1-Z	Double acting, Single rod	Except ø125	
		MB1W-Z	Double acting, Double rod	Except ø125	
CA2 *	Air cylinder	CA2-Z	Double acting, Single rod		
		CA2W-Z	Double acting, Double rod		
	End lock cylinder	CBA2	Double acting, Single rod	Head side locking type only	
CS1	Air cylinder	CS1	Double acting, Single rod		
		CS1W	Double acting, Double rod		
CS2	Air cylinder	CS2	Double acting, Single rod	Applicable to ø125 to ø250	
		CS2W	Double acting, Double rod	Applicable to ø125 to ø160	
CQ2	Air cylinder	CQ2-Z	Double acting, Single rod	Applicable to ø20 to ø100 The only mounting option selectable for sizes ø20 to ø32 is the (B) through-hole.	
		CQ2W-Z	Double acting, Double rod		Applicable to ø40 to ø100
	Axial piping type (Centralized piping type)	CQP2	Double acting, Single rod	Applicable to ø32 to ø100	
	Long stroke	CQ2-Z	Double acting, Single rod		
RQ	Compact cylinder with air cushion	RQ	Double acting, Single rod		
CV	Valve mounted air cylinder	CVM5	Double acting, Single rod		
		CV3	Double acting, Single rod		
		CVS1	Double acting, Single rod		
MGP	Compact guide cylinder	MGPM-Z	Double acting	Applicable to ø20 to ø100	
		MGPL-Z	Double acting	Applicable to ø20 to ø100	
		MGPA-Z	Double acting	Applicable to ø20 to ø100	
MGG	Guide cylinder	MGG	Double acting	Applicable to ø32 to ø100	
MGC	Guide cylinder	MGC	Double acting	Applicable to ø32 to ø50	
CNA2	Cylinder with lock	CNA2	Double acting, Single rod		
CNG	Cylinder with lock	CNG	Double acting, Single rod	Applicable to ø32, ø40	
MK	Rotary clamp cylinder	MK-Z	Double acting	Applicable to ø16 to ø63 (Rod flange type only applicable to ø32 to ø63)	

Web Catalog

* CA2□□H (Air-hydro type) comes with a heavy duty scraper as standard.

How to Order

Standard model no. **-XC4**

* For the MGP series, refer to page 1482.

With heavy duty scraper

⚠ Caution

Do not replace heavy duty scrapers.

• Since heavy duty scrapers are press-fit, do not replace the cover only, but rather the entire rod cover assembly.

The CM2 series cannot replace either heavy duty scraper or rod seal. It goes for replacing retainer assembly for the CS1 series.

Replace the CNA2 series with the lock unit.

For CS2 series bore sizes ø125 to ø160, the entire rod cover assembly will need to be replaced. For bore sizes ø180 to ø250, a special tool is required for replacement, and therefore the product will need to be sent in for factory repair.

Specifications: Same as standard type

Made to Order Common Specifications: -XC4: With Heavy Duty Scraper



16 With Heavy Duty Scraper

Symbol
-XC4

Construction (Dimensions are the same as standard.)

CM2 series Refer to page 1479 for the female rod end.

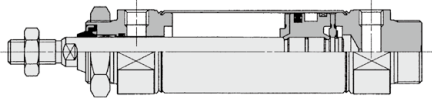

CM2W series Refer to page 1479 for the female rod end.

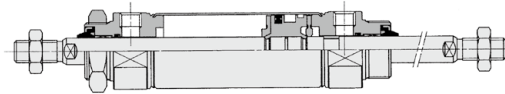

CBM series (Only with head side locking)

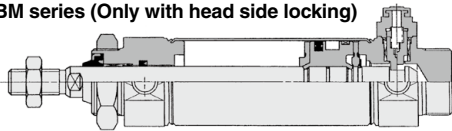

CA2 series

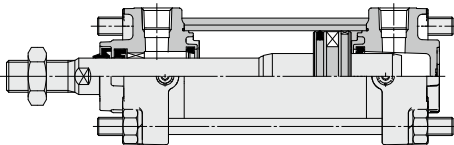

CS1 series

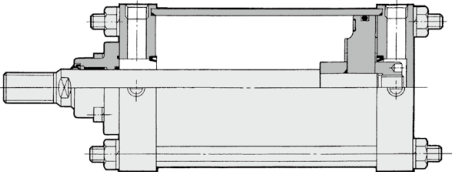

CS2 series
ø125 to ø160

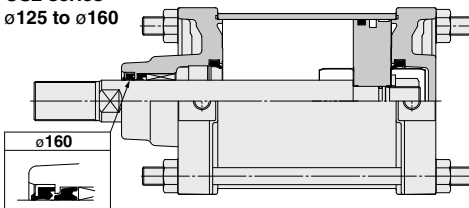

CVS1 series

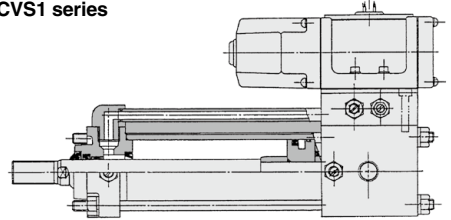

CNA2 series

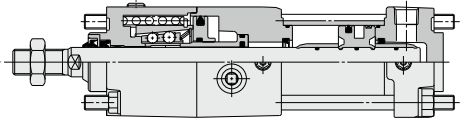

CVM series

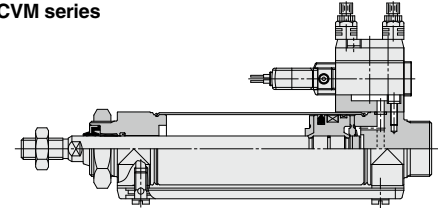

CV3 series

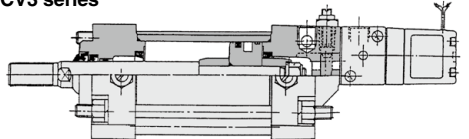

ø180 to ø250 Refer to page 1479 for dimensions.

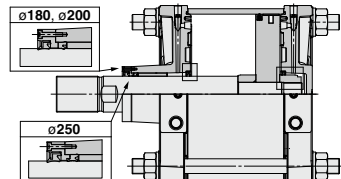

Made to Order Common Specifications: -XC4: With Heavy Duty Scraper



16 With Heavy Duty Scraper

Symbol
-XC4

Dimensions (Dimensions other than below are the same as standard type.)

CM2 series CM2W series

* (): Denotes the dimensions for the CM2W series.

Female rod end

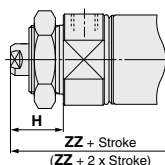

Bore size	CM2 series		CM2W series	
	H	ZZ	H	ZZ
20	24	99	24	110
25	24	99	24	110
32	24	101	24	112
40	26	130	26	140

CG1-Z1 series CG1 series

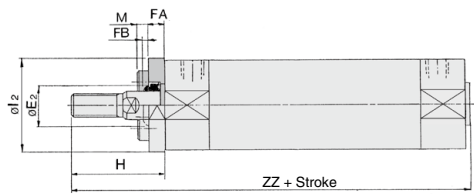

CG1 Series

Bore size	Stroke range		E ₂	FA	FB	M	l ₂	H		ZZ	
	CG1-Z1	CG1-Z						Male thread	Female thread	Male thread	Female thread
								32	Up to 1000	Up to 300 (Up to 1500)	17
40	21	8	3	3.5	47	58	29	138 (147)			109 (118)
50	26	9	3	4.5	58	66	30	158 (170)			122 (134)
63	26	9	3	5.5	72	66	30	158 (170)			122 (134)

Note) (): Long stroke

* On the axial foot and rod side flange types, the mounting bracket is wedged and bolted between the cylinder and the scraper at the time of shipment. Others are shipped together (but not assembled).

MB series

MB1 series

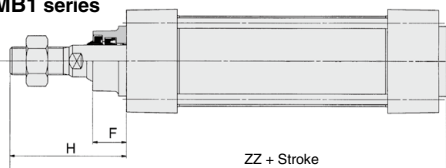

MB, MB1 Series

Bore size	F	H	ZZ
32	13	47	135
40	13	58	146
50	14	67	165
63	14	67	165
80	20	81	199
100	20	81	199

CS2 series ø180 to ø250

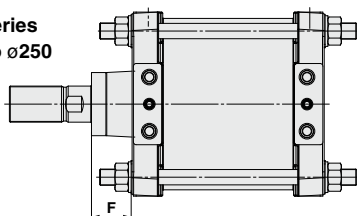

CS2 Series

Bore size	F
ø180	42
ø200	46
ø250	57

Made to Order Common Specifications: -XC4: With Heavy Duty Scraper



16 With Heavy Duty Scraper

Symbol
-XC4

Dimensions (Dimensions other than those below are the same as those of the standard type.)

CQ2 series

Double acting, Single rod

ø20, ø25 (Without auto switch magnet), ø32

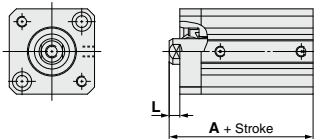

ø20, ø25 (With auto switch magnet)

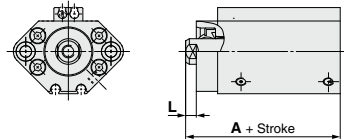

ø40 to ø100

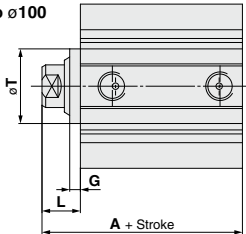

Rod end male thread

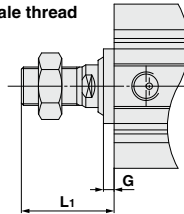

Bore size [mm]	A			G		L		L ₁		T
	50 mm stroke or less	75, 100 mm stroke	125 to 300 mm stroke	100 mm stroke or less	125 mm stroke or more	100 mm stroke or less	125 to 300 mm stroke	100 mm stroke or less	125 to 300 mm stroke	
20	34 (46)	—	—	—	—	4.5	—	18.5	—	—
25	37.5 (47.5)	—	—	—	—	5	—	22.5	—	—
32	40 (50)	50	67.5	—	—	7	12	28.5	33.5	—
40	46.5 (56.5)	56.5	77	5	10	17	22	38.5	43.5	28
50	48.5 (58.5)	58.5	78.5	5	10	18	23	43.5	48.5	35
63	54 (64)	64	80	5	10	18	23	43.5	48.5	35
80	63.5 (73.5)	73.5	91	5	10	20	25	53.5	58.5	43
100	75 (85)	85	102.5	5	10	22	27	53.5	58.5	59

(): Dimensions with auto switch magnet

Double acting, Double rod

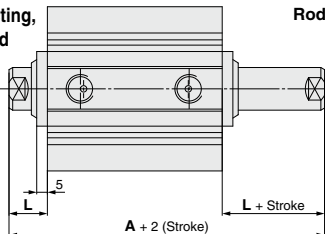

Rod end male thread

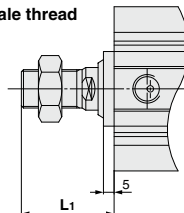

Bore size [mm]	A		L	L ₁
	Up to 50 mm stroke	75, 100 mm stroke		
40	46.5 (56.5)	56.5	17	38.5
50	48.5 (58.5)	58.5	18	43.5
63	54 (64)	64	18	43.5
80	63.5 (73.5)	73.5	20	53.5
100	75 (85)	85	22	53.5

(): Dimensions with auto switch magnet

RQ series

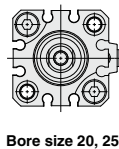
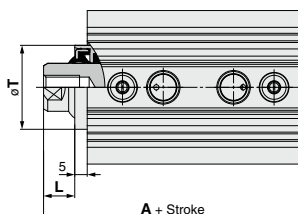

Bore size 20, 25

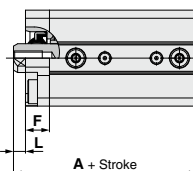

Bore size (mm)	A	F	L	T
20	46.5	10	4.5	—
25	51.5	10	5	—
32	54	10	7	—
40	61	—	17	28
50	67.5	—	18	35
63	73	—	18	35
80	83.5	—	20	43
100	98	—	22	59

- Please contact SMC for bore size 20 to 32 with both ends tapped and mounting brackets.
- Only standard strokes are applicable.

Made to Order Common Specifications: -XC4: With Heavy Duty Scraper



16 With Heavy Duty Scraper

Symbol
-XC4

Dimensions (Dimensions other than below are the same as standard type.)

CNG series

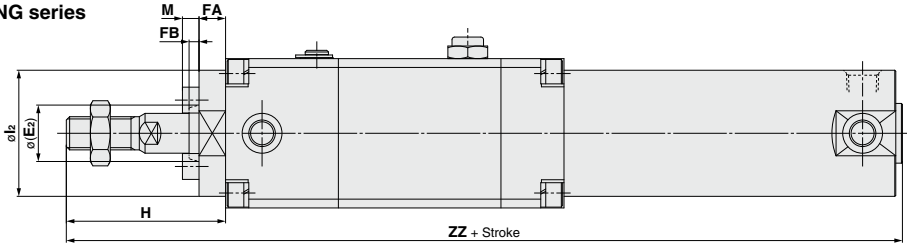

Bore size	E ₂	FA	FB	M	l ₂	H	ZZ
32	17	8	3	5	38	48	204
40	21	8	3	3.5	47	58	229

	ZZ
Long strokes	212
	238

- * The above figure shows the rubber bumper type.
- * On the axial foot type and the rod side flange type, the mounting bracket is wedged and bolted between the cylinder and the scraper at the time of shipment.

MGG□B series ø32 to ø50

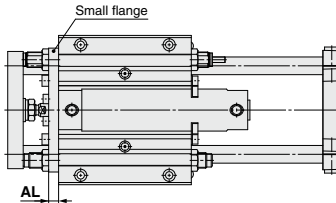

(mm)	
Bore size (mm)	AL
32	9
40	12
50	12

Specifications: Same as standard type

- Note 1) Except ø20 and ø25
- Note 2) Heavy duty scrapers are attached to the piston rod and guide rods (front and back).
- Note 3) Rod side heavy duty scrapers for ø32 to ø50 are press-fit to large and small flanges.

MGC□B series ø32 to ø50

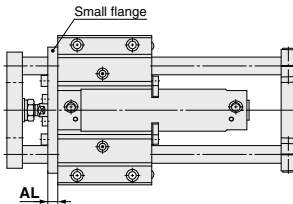

(mm)	
Bore size (mm)	AL
32	9
40	12
50	12

Made to Order Common Specifications: -XC4: With Heavy Duty Scraper



16 With Heavy Duty Scraper

Symbol
-XC4

How to Order/MGP

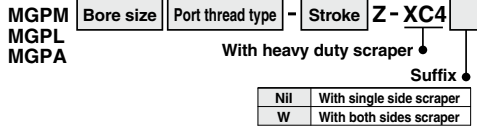

Specifications

Applicable series	MGPM	MGPL/MGPA
Bearing type	Slide bearing	Ball bushing bearing
Bore size (mm)	20, 25, 32, 40, 50, 63, 80, 100	
Minimum operating pressure	0.12 MPa	
	0.14 MPa	
Specifications other than above	Same as standard type	

Dimensions (Dimensions other than below are the same as standard type.)

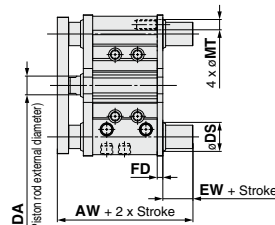
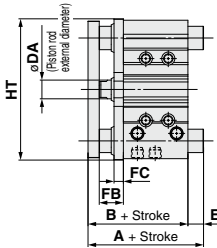

For cylinder with both sides scraper

Common Dimensions:

MGPM, MGPL, MGPA (mm)

Bore size (mm)	B	DA	FB	FC	
				MGPM	MGPL/MGPA
20	63	10	18	9	5
25	63.5	10	17	9	5
32	69.5	14	22	9	5
40	76	14	22	9	5
50	82	20	26	10	8
63	87	20	26	10	5
80	106.5	25	34	15	6
100	126	30	41	15	6

With Both Sides Scraper

Dimensions: AW, EW, FD, MT, DS (mm)

Bore size (mm)	AW	EW	FD	MT	DS*	
					MGPM	MGPL/MGPA
20	74	6	5	6	17	15
25	74.5	6	5	7	21	19
32	82.5	7	6	8.5	26	21
40	89	7	6	8.5	26	21
50	95	7	6	11	31	26
63	100	7	6	11	31	26
80	120.5	8	6	14	36	31
100	143	8	9	16	44	36

* Bypass port size for guide rod with bottom mounting

MGPM (Slide bearing) A, E, HT Dimensions (mm)

Bore size (mm)	A			E			HT
	50 st or less	Over 50 st to 200 st	Over 200 st	50 st or less	Over 50 st to 200 st	Over 200 st	
20	63	87.5	120	0	24.5	57	80
25	63.5	87.5	119.5	0	24	56	93
32	85	103.5	139.5	15.5	34	70	111.5
40	85	103.5	139.5	9	27.5	63.5	119
50	98.5	119.5	160.5	16.5	37.5	78.5	151
63	98.5	119.5	160.5	11.5	32.5	73.5	165
80	114.5	141.5	190.5	8	35	84	202
100	136.5	161.5	200.5	10.5	35.5	74.5	240

MGPL, MGPA (Ball bushing bearing) A, E, HT Dimensions (mm)

Bore size (mm)	A			E			HT	
	50 st or less	Over 50 st to 100 st	Over 100 st to 200 st	50 st or less	Over 50 st to 100 st	Over 100 st to 200 st		
20	69	86	110	127.5	6	23	47	80
25	75.5	91.5	110.5	127.5	12	28	47	93

Bore size (mm)	A			E			HT		
	50 st or less	Over 50 st to 50 st	Over 200 st	50 st or less	Over 50 st to 50 st	Over 200 st			
32	89.5	106.5	126.5	148.5	20	37	57	79	110
40	89.5	106.5	126.5	148.5	13.5	30.5	50.5	72.5	118
50	101.5	122.5	142.5	169.5	19.5	40.5	60.5	87.5	146
63	101.5	122.5	142.5	169.5	14.5	35.5	55.5	82.5	160

Bore size (mm)	A			E			HT		
	25 st or less	Over 25 st to 50 st	Over 200 st	25 st or less	Over 25 st to 50 st	Over 200 st			
80	114.5	138.5	168.5	201.5	8	32	62	95	199
100	129.5	155.5	188.5	211.5	3.5	29.5	62.5	85.5	236

Made to Order Common Specifications: -XC4: With Heavy Duty Scraper



16 With Heavy Duty Scraper

Symbol
-XC4

How to Order/MK

MKB
MKF Bore size Port thread type - Clamp stroke Rotary direction Body option Z - Auto switch - **XC4**
MKG * MKF only applicable to ø32 to ø63
With heavy duty scraper

Specifications

Bore size (mm)	16	20	25	32	40	50	63
Minimum operating pressure	0.15 MPa			(0.1 MPa)			
Specifications other than above	Same as standard type						

* The dimensions in () are the same as standard type.

Dimensions (Dimensions other than below are the same as standard type.)

ø16

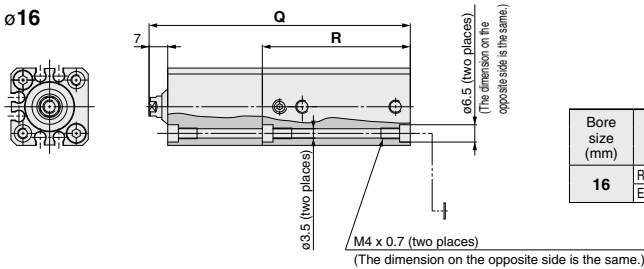

Bore size (mm)	Rod state	Clamp stroke					
		10 mm		20 mm		30 mm	
		Q	R	Q	R	Q	R
16	Retracted	78	45.5	98	55.5	118	65.5
	Extended	95.5		125.5		155.5	

ø20, ø25

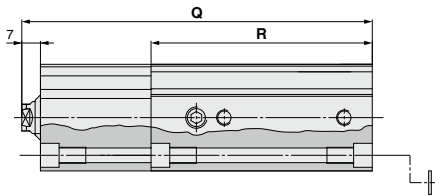

Bore size (mm)	Rod state	Clamp stroke					
		10 mm		20 mm		30 mm	
		Q	R	Q	R	Q	R
20	Retracted	99	72	119	82	139	92
	Extended	118.5		148.5		178.5	
25	Retracted	111.5	73	131.5	83	151.5	93
	Extended	131		161		191	

ø32 to ø63

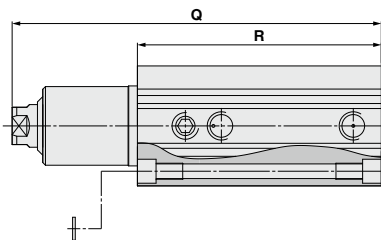

Bore size (mm)	Rod state	Clamp stroke							
		10 mm		20 mm		30 mm		50 mm	
		Q	R	Q	R	Q	R	Q	R
32	Retracted	118.5	81.5	138.5	91.5	158.5	101.5	198.5	121.5
	Extended	143.5		173.5		203.5		263.5	
40	Retracted	119	75	139	85	159	95	199	115
	Extended	144		174		204		264	
50	Retracted	137	86.5	157	96.5	177	106.5	217	126.5
	Extended	166		196		226		286	
63	Retracted	140	90	160	100	180	110	220	130
	Extended	169		199		229		289	

Made to Order Common Specifications: -XC5: Heat Resistant Cylinder (-10 to 110°C)



17 Heat Resistant Cylinder (-10 to 110°C)

Symbol
-XC5

Cylinder which changed the seal material for heat resistance (up to 110°C) in order to use under the severe ambient temperature condition which exceeds the standard specifications of -10 to 70°C (0 to 70°C for CS1, CS2 series).

Applicable Series

Series	Description	Model	Action	Note	Vol. no. (for std model)
CM2	Air cylinder	CM2-Z	Double acting, Single rod		Web Catalog
		CM2W-Z	Double acting, Double rod		
	Direct mount type	CM2R-Z	Double acting, Single rod		
MB	Air cylinder	MB-Z	Double acting, Single rod	Except with rubber bumper, with auto switch	
		MBW-Z	Double acting, Double rod	Except with rubber bumper, with auto switch	
MB1	Air cylinder	MB1-Z	Double acting, Single rod	Except with rubber bumper, with auto switch	
		MB1W-Z	Double acting, Double rod	Except with rubber bumper, with auto switch	
CA2	Air cylinder	CA2-Z	Double acting, Single rod		
		CA2W-Z	Double acting, Double rod		
CS1*	Air cylinder	CS1	Double acting, Single rod		
		CS1W	Double acting, Double rod		
CS2	Air cylinder	CS2	Double acting, Single rod	Applicable to ø125 to ø160	
		CS2W	Double acting, Double rod	Applicable to ø125 to ø160	

How to Order

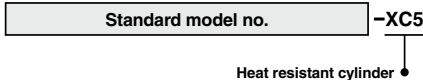

- Note 1) Please contact SMC for details on the maintenance intervals for this cylinder, which differ from those of the standard cylinder.
- Note 2) Manufacturing built-in magnet type and the one with auto switch is impossible.
- Note 3) Material of rod boot is heat resistant tarpaulin.
- Note 4) Applicable bore size of the CS1 series Lube type: ø125 to ø300
Non-lube type: ø125 to ø200

Specifications

Ambient temperature range	-10 to 110°C (0 to 110°C for CS1, CS2 series)
Seal material	Fluororubber (In the case of CS1 cylinder, cushion seal is made of NBR.)
With auto switch	Unavailable ⁽²⁾
Specifications other than above and external dimensions	Same as standard type

Made to Order Common Specifications: -XC6: Made of Stainless Steel



18 Made of Stainless Steel

Symbol
-XC6

The piston rod and rod end nut (male thread only) of this model are made of stainless steel. This model is suitable for applications in which the end of the piston rod is to be immersed in water, etc., and there is concern regarding the generation of rust or corrosion.

Applicable Series

Series	Description	Model	Action	Vol. no. (for std model)
CM2	Air cylinder	CM2-Z1	Double acting, Single rod	Web Catalog
		CM2-Z	Double acting, Single rod	
		CM2W-Z	Single acting (Spring return), Double rod	
	Non-rotating rod type	CM2K-Z	Double acting, Single rod	
		CM2KW-Z	Single acting (Spring return), Double rod	
	Direct mount type	CM2R-Z	Double acting, Single rod	
	Non-rotating rod, Direct mount type	CM2RK-Z	Double acting, Single rod	
	Centralized piping type	CM2□□	Double acting, Single rod	
	Smooth cylinder ⁽⁵⁾	CM2Y-Z	Double acting, Single rod	
	Air-hydro type	CM2H-Z	Double acting, Single rod	
Direct mount type, air-hydro type	CM2RH-Z	Double acting, Single rod		
End lock cylinder	CBM2 ⁽⁶⁾	Double acting, Single rod		
CG1	Air cylinder	CG1-Z1	Double acting, Single rod	Web Catalog
		CG1-Z	Double acting, Single rod	
	Double rod type	CG1W-Z	Double acting, Double rod	
	Direct mount type	CG1R-Z	Double acting, Single rod	
	Smooth cylinder ⁽⁵⁾	CG1Y-Z	Double acting, Single rod	
MB ⁽²⁾	Air cylinder	MB-Z ⁽⁴⁾	Double acting, Single rod	
		MBW-Z ⁽⁴⁾	Double acting, Double rod	
MB1 ⁽²⁾	Air cylinder	MB1-Z ⁽⁴⁾	Double acting, Single rod	
	End lock cylinder	CBA2 ⁽¹⁾	Double acting, Single rod	
CA2 ⁽²⁾	Air-hydro type	CA2□H	Double acting, Single rod	
		CA2W□H	Double acting, Double rod	
CS1 ⁽²⁾	Air cylinder	CS1	Double acting, Single rod	
	Air-hydro type	CS1W	Double acting, Double rod	
		CS1□H	Double acting, Single rod	

Series	Description	Model	Action	Vol. no. (for std model)
CQS	Compact cylinder	CQS	Double acting, Single rod	Web Catalog
		CQSW	Single acting (Spring return), Double rod	
	Non-rotating rod type	CQSK	Double acting, Single rod	
	Lateral load resisting type	CQS□S	Double acting, Single rod	
CQ2	Compact cylinder	CQ2-Z	Double acting, Single rod	
		CQ2W-Z	Single acting (Spring return), Double rod	
	Axial piping (Centralized piping)	CQP2-Z	Double acting, Single rod	
	Long stroke	CQ2-Z	Double acting, Single rod	
	Anti-lateral load	CQ2□S-Z	Double acting, Single rod	
	Water resistant	CQ2-R/V-Z	Double acting, Single rod	
		CQ2W-R/V-Z	Double acting, Double rod	
MU	Plate cylinder	MU-Z	Double acting, Single rod	
MGP	Compact guide cylinder	MGP-Z	Double acting	
MGG	Guide cylinder	MGG	Double acting	
MGC	Guide cylinder	MGC	Double acting	
CXS	Dual rod cylinder	CXSM	Double acting	
CXSJ	Dual rod cylinder compact type	CXSJM	Double acting	
RHC	High power cylinder	RHC	Double acting	
CV	Valve mounted air cylinder	CVM5	Double acting, Single rod	
		CVS1	Double acting, Single rod	

- Note 1) Head side locking type only
 Note 2) There is a maximum stroke limit for CA2, MB, MB1 and CS1 cylinders.
 Note 3) The MB-Z, MB1-Z, and CA2-Z made of stainless steel are applicable as "-XC6".
 Note 4) Only available for ø125 type.
 Note 5) Keep in mind that poor lubrication of the piston rod sliding surface may result in the specifications stated in the catalog not being satisfied.
 Note 6) Double end lock is available as a special order.

How to Order

CM2, CG1, MB, MB1, CA2, CS1, CQS, CQ2, MU, CV

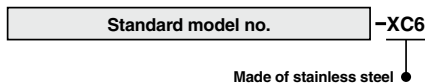

Mounting brackets, accessories, and nut material: Stainless steel

The following accessories need to be prepared separately. (Please order separately.) Refer to the "Accessories" page of each series for details.

Series	Bore size (mm)	Foot	Flange	Single knuckle joint	Double knuckle joint	Mounting nut	Rod end nut	Accessories page
CM2	20, 25, 32, 40	○	○	○	○	○	○	Web Catalog
CG1	20, 25, 32, 40, 50, 63, 80, 100	○*	○*	○	○	—	○	
	20, 25, 32, 40, 50, 63, 80, 100	—	—	○	○	—	○	

* Except bore size 20 and 25.

Maximum Stroke

Series	Double acting, Single rod	Double acting single rod with rod boot
CA2, MB, MB1	CA2: 1500 MB-MB1: 1700	1000
CS1	1200	1200

Specifications

Parts changed to stainless steel	Piston rod, Rod end nut
Specifications other than above and external dimensions	Same as standard

- Note 1) In the case of CS1 cylinder, the piston rod is only made of stainless steel. Rod end nut is not attached.
 Note 2) In the case of CQ cylinder, its snap ring and piston rod are made of stainless steel.
 Rod end nut is also made of stainless steel for rod end male thread type.

Made to Order Common Specifications: -XC6: Made of Stainless Steel



18 Made of Stainless Steel

Symbol
-XC6

Suitable for environments where rust and corrosion are likely to be generated

How to Order/CM2-Z1

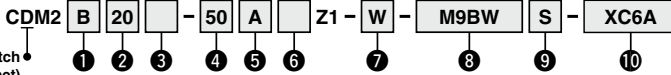

With auto switch
(Built-in magnet)

1 Mounting

B	Basic (Double-side bossed)
L	Axial foot
F	Rod flange
G	Head flange
C	Single clevis*1
D	Double clevis*1
U	Rod trunnion*1
T	Head trunnion*1
E	Integrated clevis
V	Integrated clevis (90°)
BZ	Boss-cut/Basic
FZ	Boss-cut/Rod flange
UZ	Boss-cut/Rod trunnion*1

*1 Only applicable to the XC6A

2 Bore size

20	20 mm
25	25 mm
32	32 mm
40	40 mm

3 Port thread type

Nil	Rc
TN	NPT
TF	G

4 Stroke

Refer to Table 1 for applicable strokes.

5 Cushion

Nil	Rubber bumper
A	Air cushion

6 Rod end thread

Nil	Male rod end
F	Female rod end

7 Rod end bracket

Nil	No bracket
V	Single knuckle joint
W	Double knuckle joint

* No bracket is provided for the female rod end.

8 Auto switch

For auto switch models, refer to the table of applicable auto switches.

9 Number of auto switches

Nil	2
S	1
n	n

10 Made to order

XC6A	Stainless steel rod + Stainless steel end nut
XC6B	Stainless steel rod + Stainless steel end nut + Stainless steel mounting nut + Retaining ring + Bracket

Table 1. Applicable Strokes

Bore size [mm]	Standard stroke [mm]	Max. manufacturable stroke [mm]
20		1000
25	25, 50, 75, 100,	
32	125, 150, 200,	
40	250, 300	

* The manufacturing of intermediate strokes in 1 mm increments is possible.

Specifications

Material	Stainless steel	
Changed parts	XC6A	Piston rod, Rod end nut
	XC6B	Piston rod, Rod end nut, Retaining ring, Mounting nut Bracket (Refer to the mounting brackets in the table below.)
Specifications other than the above and dimensions	Same as those of the standard type	

* The pivot bracket must be ordered separately. (Refer to the mounting brackets in the table below.)

* Rod end is not affected by this option and should be managed separately.

* The materials of the cushion needle are the same as standard. It is made from iron and nickel.

Construction

XC6A, XC6B construction

The material of the components below will be changed from standard and those not mentioned will remain the same as standard.

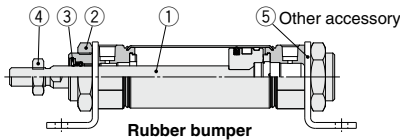

No.	1	2	3	4	5
Description	Piston rod	Mounting nut	Retaining ring	Rod end nut	Bracket (Refer to the mounting brackets below.)
XC6A	Stainless steel	No change (Steel)	No change (Steel)	Stainless steel	No change (Steel)
XC6B	Stainless steel	Stainless steel	Stainless steel	Stainless steel	Stainless steel

Mounting Brackets/Part Nos.

Mounting bracket	Min. order quantity	Bore size [mm]				Contents (for min. order quantity)
		20	25	32	40	
Foot*1	2	CM-L020B-XB12		CM-L032B-XB12	CM-L040B-XB12	2 foot brackets, 1 mounting nut
Foot	1	CM-L020BSUS		CM-L032BSUS	CM-L040BSUS	1 foot bracket*2
Flange	1	CM-F020BSUS		CM-F032BSUS	CM-F040BSUS	1 flange*2
Rod end nut	1	NT-02SUS		NT-03SUS	NT-04SUS	1 rod end nut
Mounting nut	1	SN-020BSUS		SN-032BSUS	SN-040BSUS	1 mounting nut
Single knuckle joint	1	I-020BSUS		I-032BSUS	I-040BSUS	1 single knuckle joint
Double knuckle joint	1	Y-020BSUS		Y-032BSUS	Y-040BSUS	1 double knuckle joint, 1 clevis pin, 2 retaining rings (split pins)

*1 Order two foot brackets per cylinder.

*2 The mounting nut is not included. Order it separately as required.

Made to Order Common Specifications: -XC6: Made of Stainless Steel



18 Made of Stainless Steel

Symbol
-XC6

CQ2□^R_V Series

Applicable Series

Description	Model	Action
Water resistant	CQ2□ ^R _V	Double acting, Single rod
	CQ2W□ ^R _V	Double acting, Double rod

How to Order

C□Q2□^R_V
C□Q2W□^R_V

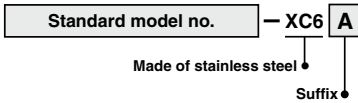

Nil	Piston rod/Retaining ring/Rod end nut material: Stainless steel
A	Piston rod/Rod end nut/Cover holding bolt material: Stainless steel

ø20 to ø32

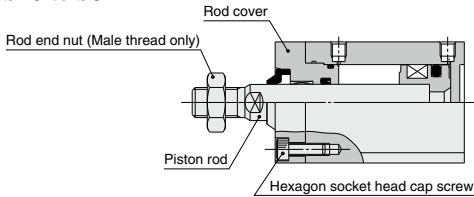

Specifications

Parts changed to stainless steel	XC6	Retaining ring, Piston rod, Rod end nut
	XC6A ^{*1}	Piston rod, Rod end nut, Cover holding bolt

Specifications other than the above and dimensions	Same as the standard type
--	---------------------------

*1 -XC6A is only applicable to ø20, ø25, and ø32 of the double acting, single rod type.

Stainless steel rod end brackets (single knuckle joint, double knuckle joint) are also available.

For details ⇨ [Web Catalog](#)

Made to Order Common Specifications: -XC6: Made of Stainless Steel



18 Made of Stainless Steel

Symbol
-XC6

MGP series

Specified Parts Changed to Stainless Steel

XC6A	①, ②, ③, ④, ⑤, ⑥
XC6B	①, ②, ⑤, ⑥

Specifications and external dimensions other than above are the same as standard type.

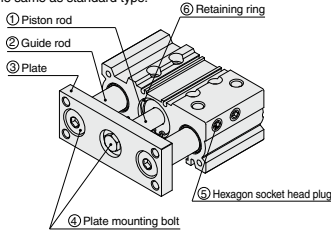

How to Order

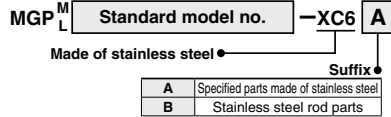

Dimensions

Bore size (mm)	XC6A			XC6B
	DA	FA	FB	DA
12	(6)	8	5	(6)
16	(8)	8	5	(8)
20	(10)	9	7	(10)
25	(10)	10	6	(10)
32	(14)	12	10	(14)
40	(14)	12	10	(14)
50	20	16	12	20
63	20	16	12	20
80	25	19	21	25
100	30	22	28	30

(mm)

The dimensions in () are the same as standard type.

CXSJM series

How to Order

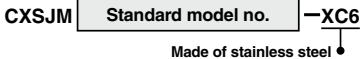

Specifications

Parts changed to stainless steel	Piston rod, retaining ring, hexagon socket head bolt, hexagon socket head set screw, dumper bolt, hexagon nut
Specifications other than above and external dimensions	Same as standard

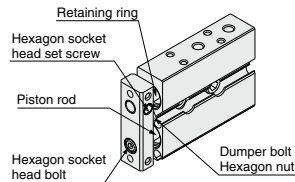

Note) The head cover retaining ring for $\phi 6$ is made of special steel.

CXSM series

How to Order

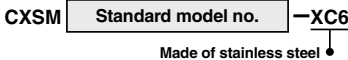

Specifications

Parts changed to stainless steel	Piston rod, retaining ring, hexagon socket head bolt, hexagon socket head set screw, dumper bolt, hexagon nut, hexagon socket head plug
Specifications other than above and external dimensions	Same as standard

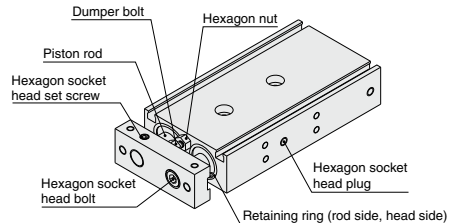

Made to Order Common Specifications: -XC6: Made of Stainless Steel



18 Made of Stainless Steel

Symbol
-XC6

The piston rod, rod end nut, and other specified parts of this model are made of stainless steel. This model is suitable for applications in which the plate is to be immersed in water, etc., and there is concern regarding the generation of rust or corrosion.

MGG series How to Order

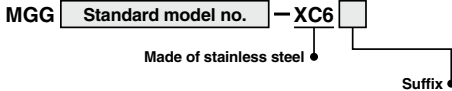

Nil	Piston rod, rod end nut made of stainless steel
A	Stainless steel used on all standard iron parts
B	Stainless steel rod end moving parts
C	Stainless steel rod parts

Specified Parts Changed to Stainless Steel

Symbol	Basic cylinder	Guide unit
-XC6		—
-XC6A	CDG1Z20 to 63-□Z-XC6 CDG1B20 to 100-□Z-XC6 (Piston rod, Rod end nut)	Flange, Front plate, Rear plate, Ball bushing (MGG□), Guide rod, End bracket, Flat washer, Spring washer, Type C retaining ring for hole, Adjustment bolt, Nut, Parallel pin, Hexagon socket head cap screw, Guide bolt
-XC6B		Front plate, Guide rod, End bracket, Flat washer, Spring washer, Parallel pin (for front plate), Guide bolt
-XC6C		Guide rod
Specifications other than above		Same as standard type

(Note) RBL (coolant resistant) type shock absorbers are used for -XC6A.

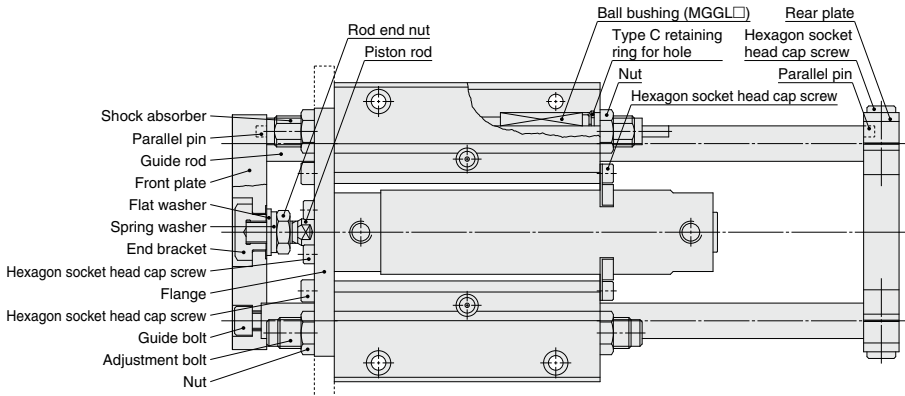

Dimensions (Dimensions other than below are the same as standard type.)

MGG□B20 to 50-□-XC6A

MGG□B20 to 50-□-XC6B

MGG□B20 to 50-□-XC6C

MGG□F20 to 50-□-XC6A

MGG□F20 to 50-□-XC6B

MGG□F20 to 50-□-XC6C

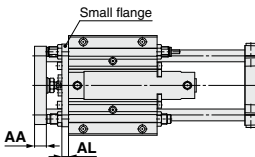

Bore size (mm)	(mm)	
	AA	AL
20	12	9
25	16	9
32	16	9
40	19	12
50	25	12

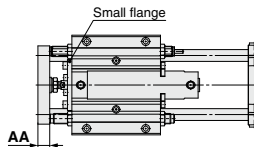

Bore size (mm)	(mm)	
	AA	
20	12	
25	16	
32	16	
40	19	
50	25	

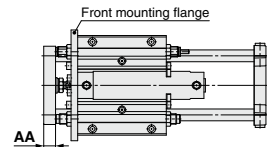

Bore size (mm)	(mm)	
	AA	
20	12	
25	16	
32	16	
40	19	
50	25	

Made to Order Common Specifications: -XC6: Made of Stainless Steel



18 Made of Stainless Steel

Symbol
-XC6

The piston rod, rod end nut, and other specified parts of this model are made of stainless steel. This model is suitable for applications in which the plate is to be immersed in water, etc., and there is concern regarding the generation of rust or corrosion.

MGC series How to Order

MGC Bearing type Mounting type Bore size Stroke Equipped/Not equipped back plate Auto switch C Nil -XC6

Note) For the XC6A, XC6B, and XC6C, this symbol is displayed when the D-A9□ or M9□ type auto switch is specified. It does not apply to other auto switches (such as the D-C7□ and H7□). (Nil)

Nil	Piston rod, rod end nut made of stainless steel
A	Stainless steel used on all standard iron parts
B	Stainless steel rod end moving parts
C	Stainless steel rod parts

Specified Parts Changed to Stainless Steel

Symbol	Basic cylinder	Guide unit
-XC6	CDG1ZA20 to 50-□-XC6 (Piston rod, Rod end nut)	—
-XC6A	CDG1BA20 to 50-□-X1057 (Piston rod, Rod end nut, Cushion valve)	Flange, Front plate, Rear plate, Ball bushing (MGCL□), Guide rod, End bracket, Flat washer, Spring washer, Type C retaining ring for hole, Hexagon socket head cap screw, Guide bolt
-XC6B		Front plate, Guide rod, End bracket, Flat washer, Spring washer, Guide bolt
-XC6C		Guide rod
Specifications other than above		Same as standard type

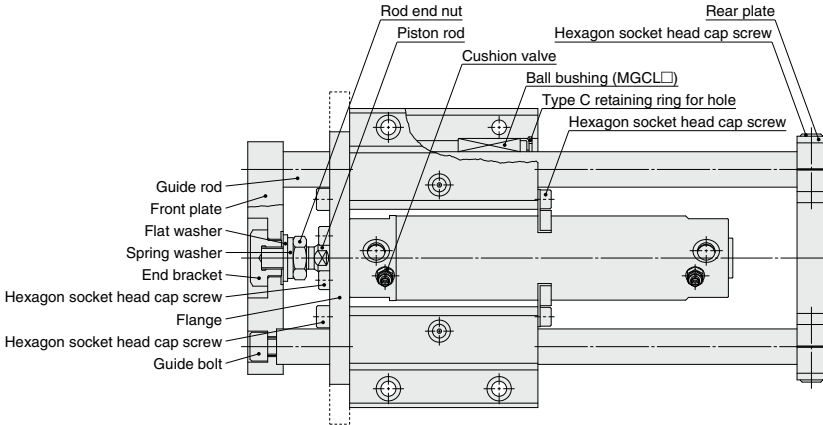

Dimensions (Dimensions other than below are the same as standard type.)

MGC□B20 to 50-□-XC6A

MGC□B20 to 50-□-XC6B

MGC□F20 to 50-□-XC6A

MGC□F20 to 50-□-XC6B

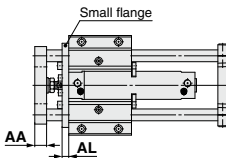

Bore size (mm)	(mm)	
	AA	AL
20	12	9
25	16	9
32	16	9
40	19	12
50	25	12

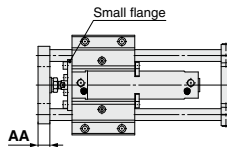

Bore size (mm)	(mm)
	AA
20	12
25	16
32	16
40	19
50	25

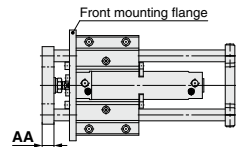

Bore size (mm)	(mm)
	AA
20	12
25	16
32	16
40	19
50	25

Made to Order Common Specifications: -XC7: Tie-rod, Cushion Valve, Tie-rod Nut, etc. Made of Stainless Steel



19 Tie-rod, Cushion Valve, Tie-rod Nut, etc. Made of Stainless Steel

Symbol
-XC7

When using in locations where the rust generation or corrosion likelihood exists, the standard parts material have been partly changed to the stainless steel.

Applicable Series

Series	Description	Model	Action	Note	Vol. no. (for std model)
MB	Standard type	MB-Z	Double acting, Single rod	Except ø125	
		MBW-Z	Double acting, Double rod	Except ø125	
	Non-rotating rod type	MBK-Z	Double acting, Single rod		
		MBKW-Z	Double acting, Double rod		
	Cylinder with end locks	MBB	Double acting, Single rod		
Smooth cylinder	MBY-Z	Double acting, Single rod			
MB1	Standard type	MB1-Z	Double acting, Single rod	Except ø125	Web Catalog
		MB1W-Z	Double acting, Double rod	Except ø125	
	Non-rotating rod type	MB1K-Z	Double acting, Single rod		
CA2	Standard type	CA2-Z	Double acting, Single rod		
		CA2W-Z	Double acting, Double rod		
	Non-rotating rod type	CA2K	Double acting, Single rod		
		CA2KW	Double acting, Double rod		
	End lock cylinder	CBA2	Double acting, Single rod		
	Air-hydro cylinder	CA2H	Double acting, Single rod		
		CA2HW	Double acting, Double rod		
	Smooth cylinder	CA2Y-Z	Double acting, Single rod		

How to Order

Standard model no. **-XC7**

Tie-rod, Cushion valve, Tie-rod nut, etc. made of stainless steel

Specifications

Component parts changed to stainless steel	Tie-rod, Tie-rod nut, Mounting bracket nut, Spring washer, Cushion valve, Retaining ring
Additional specifications	Same as standard type
Dimensions	Same as standard type

Made to Order Common Specifications: -XC8: Adjustable Stroke Cylinder/Adjustable Extension Type



20 Adjustable Stroke Cylinder/Adjustable Extension Type

Symbol
-XC8

It adjusts the extending stroke by the stroke adjustable mechanism equipped in the head side. (After the stroke is adjusted, with cushion on both sides is altered to single-sided, with cushion.)

Applicable Series

Series	Description	Model	Action	Note	Vol. no. (for std model)
CJ2	Air cylinder	CJ2-Z	Double acting	Except double clevis type and with air cushion	
	Air cylinder	CM2-Z	Double acting	Except boss-cut and clevis types	
	Non-rotating rod type	CM2K-Z	Double acting	Except boss-cut and clevis types	
	Direct mount type	CM2R-Z	Double acting	Head cover is equipped with boss.	
	End lock cylinder	CBM2	Double acting	Except clevis type Head side locking type only, Except with air cushion	
CG1	Air-hydro type	CM2H-Z	Double acting	Except clevis type	
	Direct mount type, air-hydro type	CM2HR-Z	Double acting	Head cover is equipped with boss.	
	Air cylinder	CG1-Z	Double acting	Except head side flange and clevis types, ø80, and ø100	
	Non-rotating rod type	CG1K-Z	Double acting	Except head side flange, clevis types and with air cushion	
	Direct mount type	CG1R-Z	Double acting	Except with air cushion	
MB	Direct mount, Non-rotating rod type	CG1KR-Z	Double acting	Except with air cushion	
	Air cylinder	MB-Z	Double acting	Except ø125, with rubber bumper, with auto switch, head side flange and clevis types	
	Non-rotating rod type	MBK-Z	Double acting	Except ø125, with rubber bumper, with auto switch, head side flange and clevis types	
MB1	Air cylinder	MB1-Z	Double acting	Except ø125, with rubber bumper, with auto switch, head side flange and clevis types	
	Non-rotating rod type	MB1K-Z	Double acting	Except head side flange and clevis types	
CA2	Air cylinder	CA2-Z	Double acting	Except head side flange and clevis types	Web Catalog
	Non-rotating rod type	CA2K	Double acting	Except head side flange and clevis types	
	End lock cylinder	CBA2	Double acting	Except head side flange and clevis types. Locking in head side only	
CS1	Air cylinder	CS1	Double acting	Except head side flange and clevis types	
	Air-hydro type	CS1H	Double acting	Except head side flange and clevis types	
CU	Free mount cylinder	CU	Double acting		
	Long stroke	CU	Double acting		
CQS	Compact cylinder	CQS	Double acting	Except with rubber bumper and with mounting bracket	
	Non-rotating rod	CQSK	Double acting	Except with rubber bumper and with mounting bracket	
CQ2	Compact cylinder	CQ2-Z	Double acting	Except with rubber bumper and with mounting bracket	
	Non-rotating rod type	CQ2K-Z	Double acting	Except with rubber bumper and with mounting bracket	
	Air-hydro type	CQ2H-Z	Double acting	Except with mounting bracket	
MTS	Precision cylinder	MTS	Double acting		
MGP	Compact guide cylinder	MGPM-Z	Double acting		
		MGPL-Z	Double acting		
		MGPA-Z	Double acting		
MGG	Guide cylinder	MGG	Double acting		
MGC	Guide cylinder	MGC	Double acting		

How to Order

CJ2 -

CM2 -

CG1 -

CBM2 - - -

CBA2 - - -

MB -

MB1 -

* Except head side flange and clevis types

CA2 -

* Except head side flange and clevis types

CA2K - -

* Except head side flange and clevis types

CS1 - -

* Except head side flange and clevis types

CU - -

CQSB - -

CQ2B(H) - -

MTS - -

MGP -

MGG - -

MGC - - -

Adjustable stroke cylinder/Adjustable extend type

Made to Order Common Specifications: -XC8: Adjustable Stroke Cylinder/Adjustable Extension Type



20 Adjustable Stroke Cylinder/Adjustable Extension Type

Symbol
-XC8

Specifications

Series	Stroke adjustment symbol	Stroke adjustment range (mm)
CJ2	—	0 to 15
CM2 CG1 MB MB1 CA2 CS1	A	0 to 25
	B	0 to 50
CU	A	0 to 10
	B	0 to 20
	C	0 to 30
CQ2 CQS	—	0 to 10
MGG MGC	A	0 to 25
	B	0 to 50

Series	Stroke adjustment symbol	Stroke adjustment range (mm)
MGP	A	0 to 10
	B	0 to 25
MTS	—	0 to 10 (ø8)
		0 to 25 (ø12 to ø40)
Specifications other than above		Same as standard type

Precautions

⚠ Warning

- When the cylinder is operating, if something gets caught between the stopper bracket for adjusting the stroke and the cylinder body, it could cause bodily injury or damage the peripheral equipment. Therefore, take preventive measures as necessary, such as installing a protective cover.
- To adjust the stroke, make sure to secure the wrench flats of the stopper bracket by a wrench, etc. before loosening the lock nut. If the lock nut is loosened without securing the stopper bracket, be aware that the area that joins the load to the piston rod or the area in which the piston rod is joined with the load side and the stopper bracket side could loosen first. It may cause an accident or malfunction.

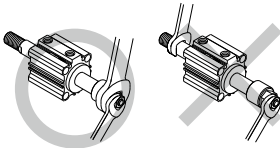

Symbol

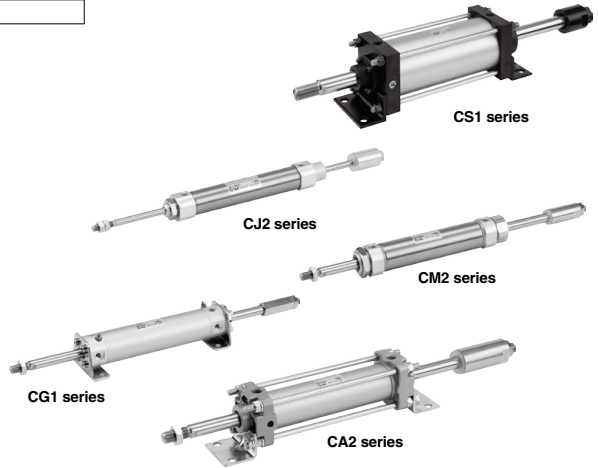
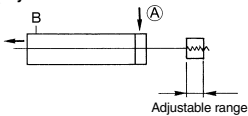

Made to Order Common Specifications: -XC8: Adjustable Stroke Cylinder/Adjustable Extension Type



20 Adjustable Stroke Cylinder/Adjustable Extension Type

Symbol
-XC8

Dimensions (Dimensions other than below are the same as standard type.)

CJ2 series

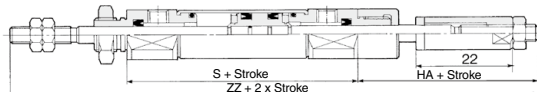

Bore size (mm)	HA	S	ZZ
10	37	49	114
16	37	50	115

(mm)

CM2 series

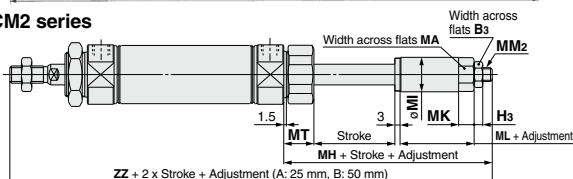

CM2 Series

Bore size (mm)	B3	H3	MA	MI	MK	MM2	MT	MH	ML	ZZ
20	10	3.6	12	14	7	M6 x 1	16.5	47	18	150
25	13	5	17	20	9	M8 x 1.25	17.5	49	18	156
32	13	5	17	20	9	M8 x 1.25	17.5	49	18	158
40	17	6	19	25	10	M10 x 1.25	21.5	60	24	198

(mm)

CG1 series

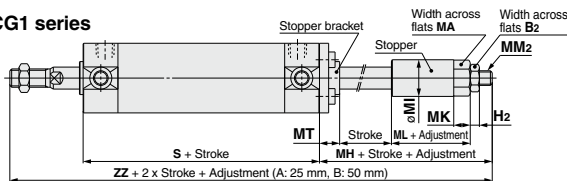

CG1 Series

Bore size (mm)	B2	H2	MA	MH	MI	MK	ML	MM2	MT	S	ZZ
20	10	3.6	12	38	14	7	18	M6 x 1	9	77	150
25	13	5	17	41	20	9	18	M8 x 1.25	11	77	158
32	13	5	17	41	20	9	18	M8 x 1.25	11	79	160
40	17	6	19	47	25	10	24	M10 x 1.25	11	87	184
50	19	8	24	60	32	13	32	M14 x 1.5	11	102	220
63	19	8	24	60	32	13	32	M14 x 1.5	13	102	220

(mm)

* On the axial foot type, the foot bracket is wedged and bolted between the cylinder and the stopper bracket at the time of shipment. On other types, it is placed in the same package (not assembled).

CG1(KR) series

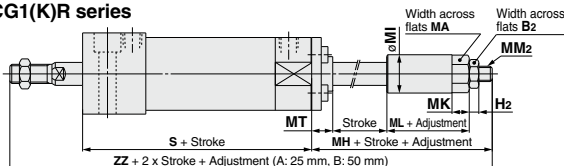

CG1(KR) Series

Bore size (mm)	B2	H2	MA	MH	MI	MK	ML	MM2	MT	S	ZZ
20	10	3.6	12	38	14	7	18	M6 x 1	9	83	148
25	13	5	17	41	20	9	18	M8 x 1.25	11	85	158
32	13	5	17	41	20	9	18	M8 x 1.25	11	91	164
40	17	6	19	47	25	10	24	M10 x 1.25	11	103	189
50	19	8	24	60	32	13	32	M14 x 1.5	11	120	225
63	19	8	24	60	32	13	32	M14 x 1.5	13	126	231

(mm)

Made to Order Common Specifications: -XC8: Adjustable Stroke Cylinder/Adjustable Extension Type



20 Adjustable Stroke Cylinder/Adjustable Extension Type

Symbol
-XC8

Dimensions (Dimensions other than below are the same as standard type.)

MB series

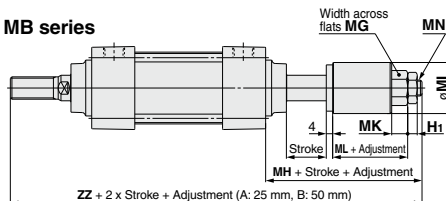

Bore size (mm)	MG	MH	MI	MK	ML	MN	ZZ
32	17	44	23	9	20	M8 x 1.25	175
40	19	48	32	10	22	M10 x 1.25	183
50	24	53	38	13	24	M14 x 1.5	205
63	24	53	38	13	24	M14 x 1.5	205
80	27	72	45	14	32	M16 x 1.5	258
100	32	75	55	17	35	M20 x 1.5	261

CA2 series

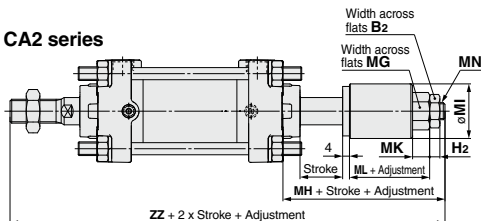

Bore size (mm)	H2	MG	MH	MI	MK	ML	MN	ZZ
40	6	19	45	32	10	22	M10 x 1.25	180
50	8	24	49	38	13	24	M14 x 1.5	197
63	8	24	49	38	13	24	M14 x 1.5	205
80	10	27	66	45	14	32	M16 x 1.5	253
100	12	32	69	55	17	35	M20 x 1.5	267

CS1 series

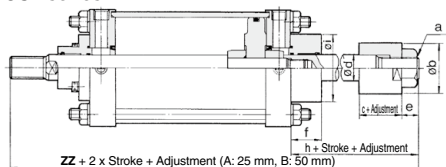

Bore size (mm)	a	ob	c	od	e	f	h	oi	ZZ
125	M30 x 1.5	70	43	36	27	40	110	90	318
140	M30 x 1.5	70	43	36	27	40	110	90	318
160	M30 x 1.5	70	43	36	27	40	110	90	336
180	M42 x 1.5	80	50	45	37.5	45	132.5	115	378.5*
200	M42 x 1.5	80	50	50	37.5	45	132.5	115	378.5*
250	M56 x 2	110	70	60	50	55	175	140	476
300	M56 x 2	110	70	70	50	55	175	140	496

* With auto switch ø180: 382.5, ø200: 387.5

CBM2 series (Only with head side locking)

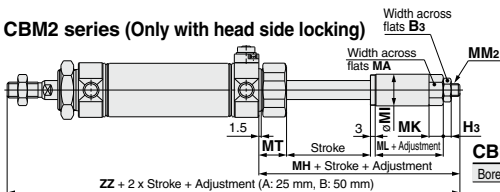

Bore size (mm)	B3	H3	MA	MI	MK	MM2	MT	MH	ML	ZZ
20	10	3.6	12	14	7	M6 x 1	16.5	47	18	150
25	13	5	17	20	9	M8 x 1.25	17.5	49	18	156
32	13	5	17	20	9	M8 x 1.25	17.5	49	18	158
40	17	6	19	25	10	M10 x 1.25	21.5	60	24	198

CBA2 series (Only with head side locking)

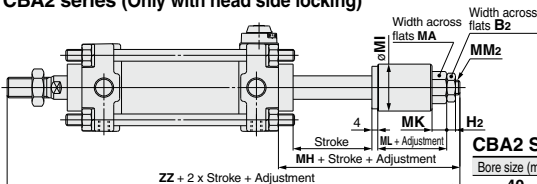

Bore size (mm)	B2	H2	MA	MI	MK	MM2	MH	ML	ZZ
40	17	6	19	32	10	M10 x 1.25	45	22	180
50	22	8	24	38	13	M14 x 1.5	51	24	199
63	22	8	24	38	13	M14 x 1.5	49	24	205
80	24	10	27	45	14	M16 x 1.5	66	32	253
100	30	12	32	55	17	M20 x 1.5	69	35	267

Made to Order Common Specifications: -XC8: Adjustable Stroke Cylinder/Adjustable Extension Type



20 Adjustable Stroke Cylinder/Adjustable Extension Type

Symbol
-XC8

Dimensions (Dimensions other than below are the same as standard type.)

MB1 series

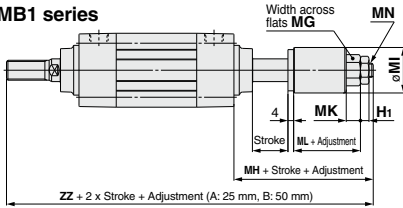

Bore size	MG	MH	MI	MK	ML	MN	ZZ	(mm)
32	17	44	23	9	20	M8 x 1.25	175	
40	19	48	32	10	22	M10 x 1.25	183	
50	24	53	38	13	24	M14 x 1.5	205	
63	24	53	38	13	24	M14 x 1.5	205	
80	27	72	45	14	32	M16 x 1.5	258	
100	32	75	55	17	35	M20 x 1.5	261	

CU series

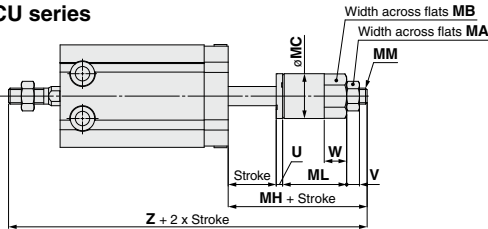

Bore size	MA	MB	oMC	MM	U	V	W	Adjustment A: 0 to 10			Adjustment B: 0 to 20			Adjustment C: 0 to 30		
								MH	ML	Z	MH	ML	Z	MH	ML	Z
10	7	8	10	M4 x 0.7	1.5	2.4	5	25	19	83	35	29	93	45	39	103
16	8	12	14	M5 x 0.8	2	4	7	28.5	20	82 (92)	38.5	30	92 (102)	48.5	40	102 (112)
20	10	15	18	M6 x 1.0	2	5	7	32	22	95.8 (105.8)	42	32	105.8 (115.8)	52	42	115.8 (125.8)
25	13	17	20	M8 x 1.25	3	5	9	38	26	110 (120)	48	36	120 (130)	58	46	130 (140)
32	17	17	20	M10 x 1.25	3	6	9	37.3	24.5	118.8 (128.8)	47.3	34.5	128.8 (138.8)	57.3	44.5	138.8 (148.8)

Note1 (): Denotes the dimensions with auto switch.

Made to Order Common Specifications: -XC8: Adjustable Stroke Cylinder/Adjustable Extension Type



20 Adjustable Stroke Cylinder/Adjustable Extension Type

Symbol
-XC8

Dimensions (Dimensions other than below are the same as standard type.)

CQ2, CQ2H series

ø12 to ø25

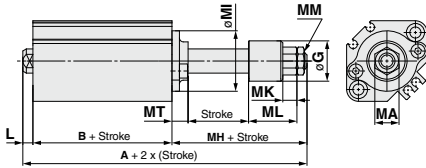

ø32 to ø100

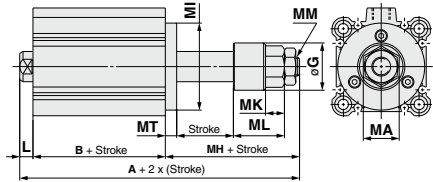

Bore size	A		B		L	MH	MT	MA	MI	MM	MK	ML	øG	Stroke adjustment range
	50 mm stroke or less	75, 100 mm stroke	50 mm stroke or less	75, 100 mm stroke										
12	57.7 (64.9)	—	25.2 (32.4)	—	3.5	29	5	8	□25 (ø15)	M4 x 0.7	5.5	20	14	5 to 30
16	58.5 (68.5)	—	26 (36)	—	3.5	29	5	10	□28 (ø20)	M5 x 0.8	5.5	20	14	5 to 30
20	67.5 (79.5)	—	26 (38)	—	4.5	37	8	12	□36 (ø25)	M6 x 1	7	24	20	5 to 50
25	71 (81)	—	29 (39)	—	5	37	8	12	□40 (ø30)	M6 x 1	7	24	20	5 to 50
32	78.5 (88.5)	88.5	30.5 (40.5)	40.5	7	41	6	17	ø38	M8 x 1.25	9	28.5	25	5 to 50 75,100
40	88 (98)	98	40 (50)	50	7	41	6	19	ø46	M10 x 1.25	10	27	25	5 to 50 75,100
50	100.5 (110.5)	110.5	40.5 (50.5)	50.5	8	52	8	24	ø57	M14 x 1.5	13	31	35	10 to 50 75,100
63	102 (112)	112	42 (52)	52	8	52	10	24	ø68	M14 x 1.5	13	31	35	10 to 50 75,100
80	125 (135)	135	51 (61)	61	10	64	12	32	ø90	M20 x 1.5	16	40	45	10 to 50 75,100
100	138.5 (148.5)	148.5	60.5 (70.5)	70.5	12	66	14	32	ø110	M20 x 1.5	16	40	45	10 to 50 75,100

Note 1) (): Denotes the dimensions with auto switch magnet
Note 2) Applicable stroke available in 5 mm increments.

Made to Order Common Specifications: -XC8: Adjustable Stroke Cylinder/Adjustable Extension Type



20 Adjustable Stroke Cylinder/Adjustable Extension Type

Symbol
-XC8

Dimensions (Dimensions other than below are the same as standard type.)

CQS series

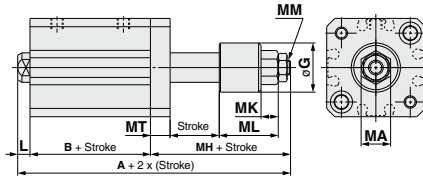

Bore size	A	B	L	MH	MT	MA	MM	MK	ML	MG	Stroke adjustment range (mm)
12	56.1 (61.1)	22 (27)	3.5	30.6	5	8	M4 x 0.7	5.5	20	14	5 to 30
16	56.5 (61.5)	22 (27)	3.5	31	5	10	M5 x 0.8	5.5	20	14	5 to 30
20	67.5 (77.5)	26 (36)	4.5	37	8	12	M6 x 1	7	24	20	5 to 50
25	71 (81)	29 (39)	5	37	8	12	M6 x 1	7	24	20	5 to 50

Note 1) (): Denotes the dimensions with auto switch magnet
Note 2) Applicable stroke available in 5 mm increments.

MTS series

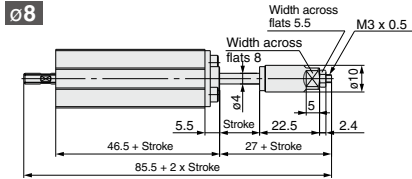

Basic Type

Bore size (mm)	A	B	LC	DA	G	GA	GB	GC	GD	GE	GF
12	145	80.5	49.5	6	13.5	42.5	6	11	4	8	M5 x 0.8
16	149.5	83	50.5	8	15.5	42.5	7	13	5	10	M6 x 1.0
20	175	106.5	50.5	10	19.5	42.5	8.5	17	5	13	M8 x 1.25
25	187	114.5	51.5	12	21.5	42.5	9	19	6	17	M10 x 1.25
32	222.5	142.5	56	16	27.5	45	10.5	24	8	22	M14 x 1.5
40	240	155	59	20	32.5	45	11.5	27	11	27	M18 x 1.5

ø12 to ø40

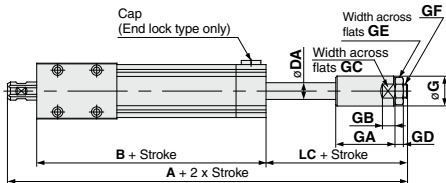

With End Lock

Bore size (mm)	A	B
12	163	98.5
16	165.5	99
20	191.5	123
25	201.5	129
32	238.5	158.5
40	258.5	173.5

Made to Order Common Specifications: -XC8: Adjustable Stroke Cylinder/Adjustable Extension Type



20 Adjustable Stroke Cylinder/Adjustable Extension Type

Symbol
-XC8

Dimensions (Dimensions other than below are the same as standard type.)

MGJ series ø20 to ø50

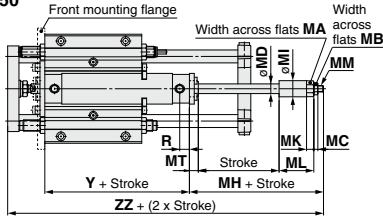

ø63

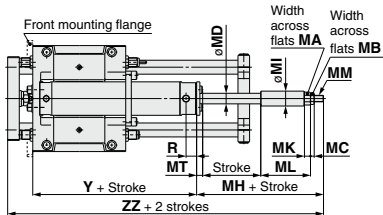

MGC series ø20 to ø50

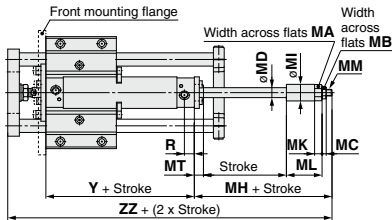

MGP series

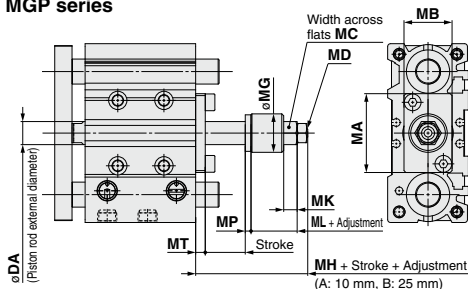

MGJ Series

Bore size (mm)	Symbol									
	R	Y	MA	MB	MC	MD	MI	MK	MM	MT
20	12	77	12	10	3.6	8	14	7	M6 x 1	9
25	12	77	17	13	5	10	20	9	M8 x 1.25	11
32	12	79	17	13	5	12	20	9	M8 x 1.25	11
40	13	87	19	17	6	16	25	10	M10 x 1.25	11
50	14	102	24	19	8	20	32	13	M14 x 1.5	11
63	14	117	24	19	8	20	32	13	M14 x 1.5	13

Bore size (mm)	Adjustment 0 to 25 mm			Adjustment 0 to 50 mm		
	MH	ML	ZZ	MH	ML	ZZ
20	63	43	179	88	68	204
25	66	43	189	91	68	214
32	66	43	191	91	68	216
40	72	49	215	97	74	240
50	85	57	254	110	82	279
63	85	57	256	110	82	281

* The piston speed for the extension side is 50 to 500 mm/s.

MGC Series

Bore size (mm)	Symbol									
	R	Y	MA	MB	MC	MD	MI	MK	MM	MT
20	12	77	12	10	3.6	8	14	7	M6 x 1	9
25	12	77	17	13	5	10	20	9	M8 x 1.25	11
32	12	79	17	13	5	12	20	9	M8 x 1.25	11
40	13	87	19	17	6	16	25	10	M10 x 1.25	11
50	14	102	24	19	8	20	32	13	M14 x 1.5	11

Bore size (mm)	Adjustment 0 to 25 mm			Adjustment 0 to 50 mm		
	MH	ML	ZZ	MH	ML	ZZ
20	63	43	179	88	68	204
25	66	43	189	91	68	214
32	66	43	191	91	68	216
40	72	49	215	97	74	240
50	85	57	254	110	82	279

* The piston speed for the extension side is 50 to 500 mm/s.

Common Dimensions: MGPM-Z, MGPL-Z, MGPA-Z

Bore size (mm)	Symbol										
	DA	MA	MB	MC	MD	øMG	MH	MK	ML	MP	MT
12	6	27	13	8	M4 x 0.7	14	20	5.5	10	3	3
16	8	28	16	10	M5 x 0.8	14	21	5.5	10	3	3
20	10	33	22	12	M6 x 1	20	27	7	14	3	4
25	12	41	25	12	M6 x 1	20	28	7	14	3	5
32	16	51	32	17	M8 x 1.25	25	35	9	18.5	4	6
40	16	60	32	19	M10 x 1.25	25	34.5	10	17	4	6
50	20	71	38	24	M14 x 1.5	35	42.5	13	21	4	8
63	20	84	50	24	M14 x 1.5	35	43	13	21	4	8
80	25	114	50	32	M20 x 1.5	45	57	16	30	4	9
100	30	140	65	32	M20 x 1.5	45	60	16	30	4	12

Made to Order Common Specifications: -XC9: Adjustable Stroke Cylinder/Adjustable Retraction Type



21 Adjustable Stroke Cylinder/Adjustable Retraction Type

Symbol

-XC9

The retract stroke of the cylinder can be adjusted by the adjustment bolt.

Applicable Series

Series	Description	Model	Action	Note	Vol. no. (for std model)
CJ2	Air cylinder	CJ2-Z	Double acting, Single rod	Except double-side bossed, double clevis type, double foot, head side flange and with air cushion	Web Catalog
	Non-rotating rod	CJ2K-Z	Double acting, Single rod	Except double-side bossed, double clevis type, double foot and head side flange	
	Direct mount type	CJ2R-Z	Double acting, Single rod		
	Non-rotating rod/Direct mount type	CJ2RK-Z	Double acting, Single rod		
CM2	Smooth cylinder	CJ2Y-Z	Double acting, Single rod	Except double-side bossed, double clevis type, double foot and head side flange	
	Air cylinder	CM2-Z	Double acting, Single rod	Except boss-cut and clevis types	
	Non-rotating rod	CM2K-Z	Double acting, Single rod	Except boss-cut and clevis types	
	Direct mount type	CM2R-Z	Double acting, Single rod	Except the head cover with boss	
CG1	Non-rotating rod/Direct mount type	CM2RK-Z	Double acting, Single rod	Except the head cover with boss	
	Smooth cylinder	CM2Y-Z	Double acting, Single rod	Except boss-cut and clevis types	
	Air cylinder	CG1-Z	Double acting, Single rod	Except head side flange and clevis types, ø80, and ø100	
	Non-rotating rod	CG1K-Z	Double acting, Single rod	Except head side flange, clevis types and with air cushion	
MB	Direct mount type	CG1R-Z	Double acting, Single rod	Except with air cushion	
	Non-rotating rod/Direct mount type	CG1KR-Z	Double acting	Except with air cushion	
	Air cylinder	MB-Z	Double acting, Single rod	Except ø125, with rubber bumper, with auto switch, head side flange and clevis types	
	Non-rotating rod	MBK-Z	Double acting, Single rod	Except ø125, with rubber bumper, with auto switch, head side flange and clevis types	
MB1	Air cylinder	MB1-Z	Double acting, Single rod	Except ø125, with rubber bumper, with auto switch, head side flange and clevis types	
	Non-rotating rod	MB1K-Z	Double acting, Single rod	Except head side flange and clevis types	
CA2	Air cylinder	CA2-Z	Double acting, Single rod	Except head side flange and clevis types	
	Non-rotating rod	CA2K	Double acting, Single rod	Except head side flange and clevis types	
	End lock cylinder	CBA2	Double acting, Single rod	Except head side flange and clevis types	
CS1	Air cylinder	CS1	Double acting, Single rod	Except head side flange and clevis types, ø125 to ø160	
CS2	Air cylinder	CS2	Double acting, Single rod	Except head side flange and clevis types, ø125 to ø160	
	Smooth cylinder	CS2Y	Double acting, Single rod	Except head side flange and clevis types, ø125 to ø160	
CQS	Compact cylinder	CQS	Double acting, Single rod	Except with rubber bumper and with mounting bracket	
	Non-rotating rod type	CQSK	Double acting, Single rod	Except with rubber bumper and with mounting bracket	
CQ2	Compact cylinder	CQ2-Z	Double acting, Single rod	Except with rubber bumper and with mounting bracket	
	Non-rotating rod	CQ2K-Z	Double acting, Single rod	Except with rubber bumper and with mounting bracket	
MGP	Compact guide cylinder	MGPM-Z	Double acting		
		MGPL-Z	Double acting		
		MGPA-Z	Double acting		
MGG	Guide cylinder	MGG	Double acting		
MGC	Guide cylinder	MGC	Double acting		

How to Order

CJ2	Mounting type	Bore size	Stroke	Z - XC9			
CM2	Mounting type	Bore size	Stroke	Cushion	Rod end type symbol	Z - XC9	Stroke adjustment symbol
* Except boss-cut and clevis types							
CM2R	Mounting type	Bore size	Stroke	Rod end type symbol	Z - XC9	Stroke adjustment symbol	
CG1	Mounting type	Type	Bore size	Stroke	Rod end type symbol	Stroke adjustment symbol	Z - XC9
* Except clevis type							
MB	Mounting type	Bore size	Stroke	Suffix	Stroke adjustment symbol	Z - XC9	
MB1	* Except head side flange and clevis types						
CA2	Mounting type	Type	Bore size	Stroke	Suffix	Stroke adjustment symbol	Z - XC9
* Except head side flange and clevis types							
CA2K	Mounting type	Type	Bore size	Stroke	Suffix	Stroke adjustment symbol	- XC9
* Except head side flange and clevis types							
CBA2	Mounting type	Type	Bore size	Stroke	Stroke adjustment symbol	R	Manual release type - XC9
* Except head side flange and clevis types							
CS1	Mounting type	Tubing material	Type	Bore size	Stroke	Suffix	Stroke adjustment symbol - XC9
* Except head side flange and clevis types							
CS2	Mounting type	Bore size	Port suffix	Stroke	Suffix	Stroke adjustment symbol - XC9	
* Except head side flange and clevis types							
CS2Y	Mounting type	Bore size	Port suffix	Stroke	Suffix	Stroke adjustment symbol - XC9	
* Except head side flange and clevis types							
CQ2B	Bore size	Stroke	D (M) (Z)	XC9			
CQSB	Bore size	Stroke	D (M)	XC9			
MGP	Bearing type	Bore size	Stroke	Stroke adjustment symbol	Z - XC9		
MGG	Bearing type	Mounting type	Bore size	Port thread type	Stroke	Stroke adjustment symbol - XC9	
MGC	Bearing type	Mounting type	Bore size	Port thread type	Stroke	Stroke adjustment symbol - XC9	Equipment not equipped back side - XC9

Adjustable stroke cylinder/Adjustable retract type ●

(After adjusting stroke, both-side cushion type is changed into single side cushion type. CQ2 is without cushion.)

Made to Order Common Specifications: -XC9: Adjustable Stroke Cylinder/Adjustable Retraction Type



21 Adjustable Stroke Cylinder/Adjustable Retraction Type

Symbol
-XC9

Specifications

Series	Stroke adjustment symbol	Stroke adjustment range (mm)
CJ2	—	0 to 15
CM2 CG1 MB MB1 CA2 CS1	A	0 to 25
	B	0 to 50
CQ2 CQS	—	0 to 10

Series	Stroke adjustment symbol	Stroke adjustment range (mm)
MGP	A	0 to 10
	B	0 to 25
MGG MGC	A	0 to 25
	B	0 to 50
Specifications other than above		Same as standard type

Precautions

⚠ Caution

1. When air is supplied to the cylinder, if the stroke adjustment bolt is loosened in excess of the allowable stroke adjustment amount, be aware that the stroke adjustment bolt could fly out or air could be discharged, which could injure personnel or damage the peripheral equipment.

2. Adjust the stroke when the cylinder is not pressurized.
If it is adjusted in the pressurized state, the seal of the adjustment section could become deformed, leading to air leakage.



Symbol

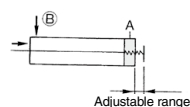

Dimensions (Dimensions other than below are the same as standard type.)

CJ2 series

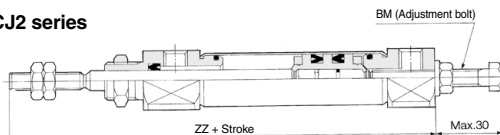

			(mm)
Bore size (mm)	BM	ZZ	
10	M5 x 0.8	74	
16	M5 x 0.8	75	

CM2 series

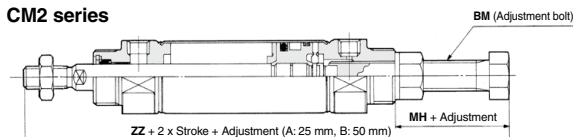

				(mm)
Bore size (mm)	BM	MH	ZZ	
20	M10 x 1.25	26.5	142.5	
25	M14 x 1.5	29	149	
32	M14 x 1.5	29	151	
40	M16 x 1.5	32	186	

Made to Order Common Specifications: -XC9: Adjustable Stroke Cylinder/Adjustable Retraction Type



21 Adjustable Stroke Cylinder/Adjustable Retraction Type

Symbol

-XC9

Dimensions (Dimensions other than below are the same as standard type.)

CM2R series

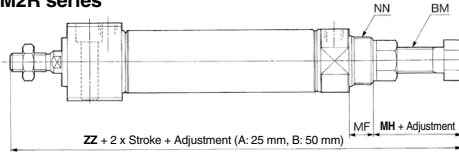

CM2R

Bore size (mm)	BM	MF	MH	NN	ZZ
20	M10 x 12.5	13	26.5	M20 x 1.5	142.5
25	M14 x 1.5	13	29	M26 x 1.5	149
32	M14 x 1.5	13	29	M26 x 1.5	151
40	M16 x 1.5	16	32	M32 x 2	186

CG1 series

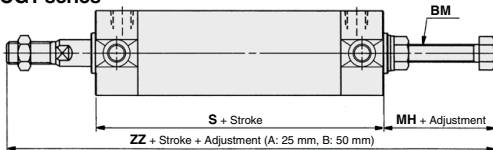

CG1

Bore size (mm)	BM	S	Rubber bumper		Air cushion	
			MH	ZZ	MH	ZZ
20	M6 x 1	77	23	135	21	133
25	M6 x 1	77	23	140	21	138
32	M8 x 1.25	79	25	144	25	144
40	M12 x 1.75	87	40	177	39	176
50	M12 x 1.75	102	33	193	37	197
63	M16 x 2	102	40	200	44	204

MB series

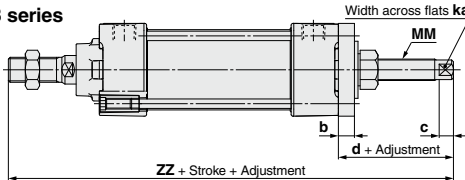

* In the case of axial foot type, the cushion is shipped after mounting. On other types, it is placed in the same package (not assembled).

* Dimensions other than above are the same as the CG1 series, long stroke type.

MB, MB1 Common

Bore size (mm)	b	c	d	ka	MM	ZZ
32	9	8	40	8	M12 x 1.25	171
40	9	8	39.5	8	M12 x 1.25	174.5
50	11	8	46	13	M16 x 1.5	198
63	11	8	52	17	M20 x 1.5	204
80	15	10	61	19	M24 x 1.5	247
100	15	10	61.5	19	M24 x 1.5	247.5

MB1 series

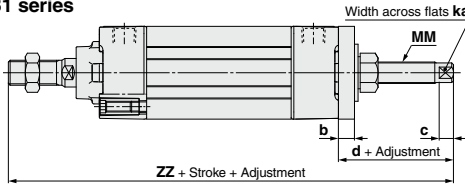

CA2 series

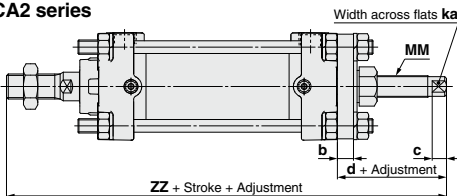

CA2-Z

Bore size (mm)	b	c	d	ka	MM	ZZ
40	9	8	36	8	M12 x 1.25	171
50	11	8	42	13	M16 x 1.5	190
63	11	8	44	17	M20 x 1.5	200
80	15	10	54	19	M24 x 1.5	241
100	15	10	55.5	19	M24 x 1.5	253.5

CA2K, CBA2 (With lock on rod side only)

Bore size (mm)	b	c	d	ka	MM	ZZ
40	9	8	44	11	M16 x 1.5	179
50	11	8	42	11	M16 x 1.5	190
63	11	8	48	14	M20 x 1.5	204
80	15	10	55	19	M24 x 1.5	242
100	15	10	57	19	M24 x 1.5	255

CS1 series

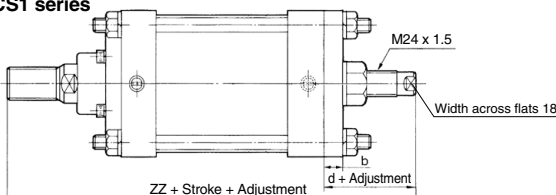

CS1

Bore size (mm)	b	d	ZZ
125	19	66	274
140	19	66	274
160	22	62	288

Made to Order Common Specifications: -XC9: Adjustable Stroke Cylinder/Adjustable Retraction Type



21 Adjustable Stroke Cylinder/Adjustable Retraction Type

Symbol
-XC9

Dimensions (Dimensions other than below are the same as standard type.)

CS2 series

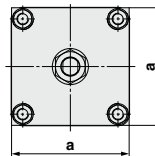
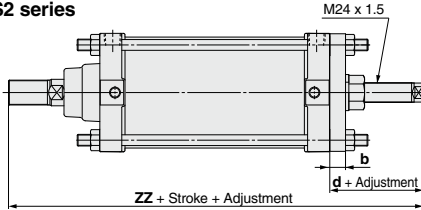

Bore size (mm)	a	b	d	ZZ
125	142	19	63	271
140	155	19	63	271
160	174	19	59	285

CQS series

ø12, ø16

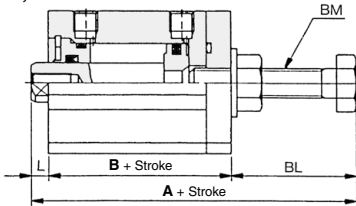

ø20, ø25

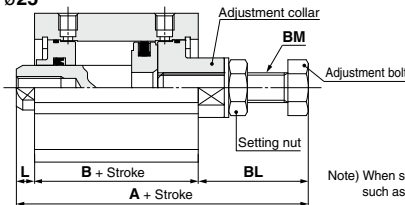

Bore size (mm)	A	B	L	BL	BM	Manufacturable stroke
12	50.5 (54.5)	22 (27)	3.5	25 (29)	M5 x 0.8	5 to 30
16	51 (56)	22 (27)	3.5	25.5	M6 x 1	
20	61 (71)	26 (36)	4.5	30.5	M8 x 1.25	
25	63.5 (73.5)	29 (39)	5	29.5	M8 x 1.25	5 to 50

Note 1) (): Denotes the dimensions with auto switch.
Note 2) Applicable stroke available in 5 mm increments.

Note) When securing the adjustment bolt, clamp the width across flats of the adjustment collar with a tool, such as a spanner and tighten the setting nut with a tool, such as other spanner to secure the bolt firmly.

CQ2 series

ø12, ø16, ø40 to ø100

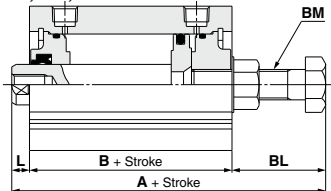

ø20, ø25, ø32

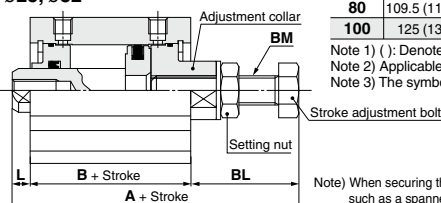

Bore size (mm)	A		B		L	BL	BM	Manufacturable stroke
	50 mm stroke or less	75, 100 mm stroke	50 mm stroke or less	75, 100 mm stroke				
12	52 (59.2)	—	25.2 (32.4)	—	3.5	23.3	M5 x 0.8	5 to 30
16	53 (63)	—	26 (36)	—	3.5	23.5	M6 x 1	
20	61 (73)	—	26 (38)	—	4.5	30.5	M8 x 1.25	5 to 50
25	63.5 (73.5)	—	29 (39)	—	5	29.5	M8 x 1.25	
32	65.5 (75.5)	75.5	30.5 (40.5)	40.5	7	28	M8 x 1.25	5 to 50
40	84 (94)	94	40 (50)	50	7	37	M12 x 1.5	75, 100
50	84.5 (94.5)	94.5	40.5 (50.5)	50.5	8	36	M12 x 1.5	
63	88.5 (98.5)	98.5	42 (52)	52	8	38.5	M16 x 1.5	10 to 50
80	109.5 (119.5)	119.5	51 (61)	61	10	48.5	M20 x 1.5	75, 100
100	125 (135)	135	60.5 (70.5)	70.5	12	52.5	M24 x 1.5	

Note 1) (): Denotes the dimensions with auto switch.
Note 2) Applicable stroke available in 5 mm increments.
Note 3) The symbol is X526 for the long stroke type. → **Web Catalog**

Note) When securing the stroke adjustment bolt, clamp the width across flats of the adjustment collar with a tool, such as a spanner and tighten the setting nut with a tool, such as other spanner to secure the bolt firmly.

Made to Order Common Specifications: -XC9: Adjustable Stroke Cylinder/Adjustable Retraction Type



21 Adjustable Stroke Cylinder/Adjustable Retraction Type

Symbol
-XC9

Dimensions (Dimensions other than below are the same as standard type.)

MGP series

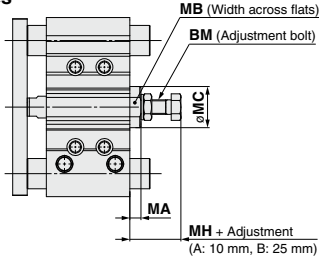

Common Dimensions: MGPM, MGPL, MGPA (mm)

Bore size (mm)	BM	MA	MB	MC	MH
12	M5 x 0.8	5	8	12.5	17
16	M6 x 1	5	10	14	19
20	M8 x 1.25	6.5	13	16	25
25	M8 x 1.25	6.5	13	16	24
32	M8 x 1.25	6.5	19	21	25
40	M12 x 1.5	9	27	30	32.5
50	M12 x 1.5	9	30	34	32.5
63	M16 x 1.5	10	36	40	37
80	M20 x 1.5	15	41	46	48.5
100	M24 x 1.5	18	46	52	55.5

MGG series ø20 to ø50

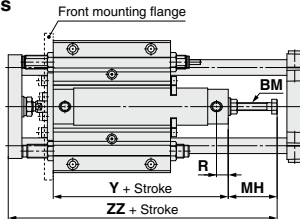

MGG Series (mm)

Bore size (mm)	R	Y	BM	Adjustment 0 to 25 mm		Adjustment 0 to 50 mm	
				MH	ZZ	MH	ZZ
20	12	77	M6 x 1	48	164	73	189
25	12	77	M6 x 1	48	171	73	196
32	12	79	M8 x 1.25	50	175	75	200
40	13	87	M12 x 1.75	65	208	90	233
50	14	102	M12 x 1.75	58	227	83	252
63	14	117	M16 x 2	65	236	90	261

* The piston speed for the retraction side is 50 to 500 mm/s.

ø63

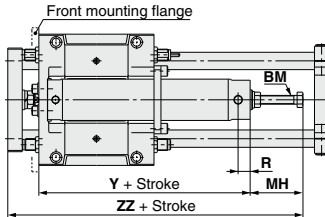

MGC series ø20 to ø50

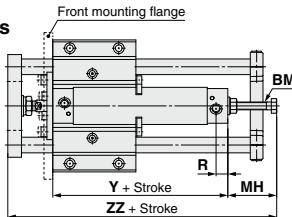

MGC Series (mm)

Bore size (mm)	R	Y	BM	Adjustment 0 to 25 mm		Adjustment 0 to 50 mm	
				MH	ZZ	MH	ZZ
20	12	77	M6 x 1	46	162	71	187
25	12	77	M6 x 1	46	169	71	194
32	12	79	M8 x 1.25	50	175	75	200
40	13	87	M12 x 1.75	64	207	89	232
50	14	102	M12 x 1.75	62	231	87	256

* The piston speed for the retraction side is 50 to 500 mm/s.

Made to Order Common Specifications: -XC10: Dual Stroke Cylinder/Double Rod Type



22 Dual Stroke Cylinder/Double Rod Type

Symbol
-XC10

Two cylinders are constructed as one cylinder in a back-to-back configuration allowing the cylinder stroke to be controlled in three steps.

Applicable Series

Series	Description	Model	Action	Note	Vol. no. (for std model)
CJ2	Air cylinder	CJ2-Z	Double acting, Single rod	Excludes the type with an air cushion, a rod end bracket, or a pivot bracket as well as "E," "D," "M," and "G"	Web Catalog
	Non-rotating rod type	CJ2K-Z	Double acting, Single rod	Excludes the type with a rod end bracket or a pivot bracket as well as "E," "D," "M," and "G"	
CM2	Air cylinder	CM2-Z	Double acting, Single rod	Excludes the type with an air cushion, a rod end bracket, or a pivot bracket	
	Non-rotating rod type	CM2K-Z	Double acting, Single rod	Excludes the type with an air cushion, a rod end bracket, or a pivot bracket	
CG1	Smooth cylinder	CM2Y-Z	Double acting, Single rod	Excludes the type with a rod end bracket or a pivot bracket	
	Air cylinder	CG1-Z	Double acting, Single rod		
MB	Non-rotating rod type	CG1K-Z	Double acting, Single rod	Except with air cushion and with rod boot	
	Air cylinder	MB-Z	Double acting, Single rod	Except ø125, clevis and trunnion types	
	Non-rotating rod type	MBK-Z	Double acting, Single rod	Except clevis and trunnion types	
MB1	With end lock type	MBB	Double acting, Single rod	Except clevis and trunnion types	
	Air cylinder	MB1-Z	Double acting, Single rod	Except ø125, clevis and trunnion types	
CA2	Non-rotating rod type	MB1K-Z	Double acting, Single rod	Except clevis and trunnion types	
	Air cylinder	CA2-Z	Double acting, Single rod	Except clevis and trunnion types	
	Non-rotating rod type	CA2K	Double acting, Single rod	Except clevis and trunnion types	
CS1	End lock cylinder	CBA2	Double acting, Single rod	Except clevis and trunnion types	
	Air cylinder	CS1	Double acting, Single rod	Except clevis and trunnion types	
CS2	Air-hydro cylinder	CS1H	Double acting, Single rod	Except clevis and trunnion types	
	Air cylinder	CS2	Double acting, Single rod	Except clevis and trunnion types	
CQS	Smooth cylinder	CS2Y	Double acting, Single rod	Except clevis and trunnion types	
	Compact cylinder	CQS	Double acting, Single rod	Except with bracket	
CQ2	Non-rotating rod type	CQSK	Double acting, Single rod	Except with bracket	
	Compact cylinder	CQ2-Z	Double acting, Single rod	Except with bracket	
CQ2B	Non-rotating rod type	CQ2K-Z	Double acting, Single rod	Except with bracket	
	Air-hydro cylinder	CQ2H-Z	Double acting, Single rod	Except with bracket	

How to Order

CJ2	Mounting type	Bore size	—	Stroke A	+	Stroke B	Z	—	XC10								
CM2	Mounting type	Bore size	—	Stroke A	Suffix	+	Stroke B	Suffix	Z	—	XC10						
CG1	Mounting type	Type	Bore size	—	Stroke A	Rod boot suffix	+	Stroke B	Rod end thread*1	Rod boot suffix	Z	—	XC10				
*1 The rod end thread shape is the same for both strokes A and B.																	
MB	Mounting type	Bore size	—	Stroke A	Suffix	+	Stroke B	Suffix	Z	—	XC10						
MB1	Mounting type	Bore size	—	Stroke A	Suffix	+	Stroke B	Suffix	Z	—	XC10						
MBB	Mounting type	Bore size	—	Stroke A	Suffix	—	Lock position	Manual release type	+	Stroke B	Suffix	—	Lock position	Symbol of manual release	—	XC10	
CA2	Mounting type	Type	Bore size	—	Stroke A	Suffix	+	Stroke B	Suffix	Z	—	XC10					
CA2K	Mounting type	Type	Bore size	—	Stroke A	Suffix	+	Stroke B	Suffix	—	XC10						
CBA2	Mounting type	Type	Bore size	—	Stroke A	Suffix	—	Lock position	Manual release type	+	Stroke B	Suffix	—	Lock position	Symbol of manual release	—	XC10
CS1	Mounting type	Tubing material	Type	Bore size	—	Stroke A	Suffix	+	Stroke B	Suffix	—	XC10					
CS2	Mounting type	Bore size	Port suffix	—	Stroke A	Suffix	+	Stroke B	Suffix	—	XC10						
CQ2B	Bore size	—	Stroke S ₁	+	Stroke S ₂	D (C)(M)(Z)	—	XC10									
CQSB	Bore size	—	Stroke S ₁	+	Stroke S ₂	D (C)(M)	—	XC10									

Dual stroke cylinder*

Made to Order Common Specifications: -XC10: Dual Stroke Cylinder/Double Rod Type



22 Dual Stroke Cylinder/Double Rod Type

Symbol
-XC10

Specifications

Series	Bore size (mm)	Maximum manufacturable stroke (mm)
CJ2	10, 16	300 (Maximum 150 on one side)
CM2	20 to 40	1000 (A + B stroke)
CG1	20	1500 (A + B stroke)
	25	1500 (A + B stroke)
	32	1500 (A + B stroke)
	40	1500 (A + B stroke)
	50, 63	1500 (A + B stroke)
MB MB1	32 to 100	1000 (A + B stroke)
CA2	40 to 100	1000 (A + B stroke)
CS1	125, 140	1000 (A + B stroke)
	160 to 300	1200 (A + B stroke)

Series	Bore size (mm)	Maximum manufacturable stroke (mm)
CS2	125, 140	1000 (A + B stroke)
	160, 180	1200 (A + B stroke)
	200	998 (A + B stroke)
	250	813 (A + B stroke)
	320	495 (A + B stroke)
CQS CQ2	12, 16	60 (Maximum 30 on one side)
	20, 25	100 (Maximum 50 on one side)
CQ2	32, 40	200 (Maximum 100 on one side)
	50 to 100	200 (Maximum 100 on one side)
Specifications other than above	Same as standard type	

Symbol

Function

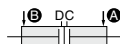

When air pressure is supplied to ports **A** and **B**, both A and B strokes retract.



When air pressure is supplied to ports **B** and **C**, A out strokes.

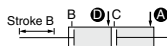

When air pressure is supplied to ports **A** and **D**, B out strokes.

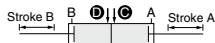

When air pressure is supplied to ports **C** and **D**, both strokes A and B out strokes.



CJ2 series

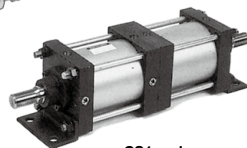

CS1 series



CG1 series



CA2 series

Made to Order Common Specifications: -XC10: Dual Stroke Cylinder/Double Rod Type



22 Dual Stroke Cylinder/Double Rod Type

Symbol
-XC10

Dimensions (Dimensions other than below are the same as standard type.)

CJ2 series

Bore size (mm)	NB	S	Z
10	21	36.5	150
16	21	37.5	152

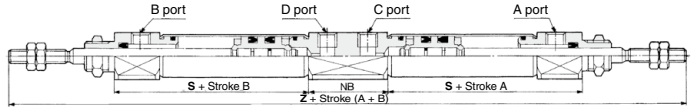

CM2 series

Bore size (mm)	GC	GD	SA	SB	ZZ
20	7	24	47	78	207
25	7	24	47	78	215
32	7	24	49	80	219
40	10.5	33.5	66.5	110.5	277

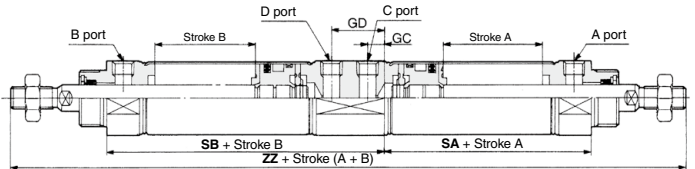

CG1 series

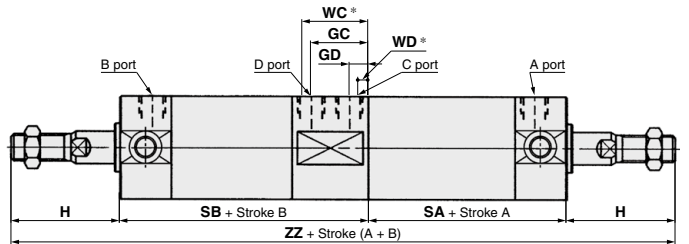
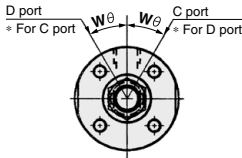

Bore size	GC	GD	H	SA	SB	Wθ	Air cushion		
							WC	WD	ZZ
20	20.5 (21)	8.5 (9)	35	56.5 (56)	85.5 (86)	30°	(25)	(5)	212
25	21 (21.5)	9 (8.5)	40	56	86	30°	(25)	(5)	222
32	23	9	40	58	90	30°	(27)	(5)	228
40	23.5 (25)	7.5 (9)	50	66.5 (65)	97.5 (99)	20°	(29)	(5)	264
50	29	13	58	75	117	20°	(33)	(9)	308
63	28	12	58	76	116 (116)	20°	(32)	(8)	308

* (): With air cushion

MB series

Bore size	GC	NA	NB	S	ZZ
32	36	64	10.6	178	272
40	38	64	10.6	178	280
50	41	73	10.6	198	314
63	43	73	10.6	198	314
80	52	90	14.6	242	386
100	52	90	14.6	242	386

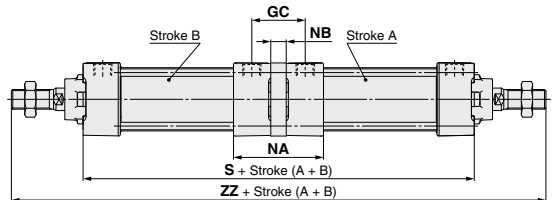

MB1 series

Bore size	GC	NA	NB	S	ZZ
32	36	62	10.6	178	272
40	38	62	10.6	178	280
50	41	71	10.6	198	314
63	43	71	10.6	198	314
80	52	88	14.6	242	386
100	52	88	14.6	242	386

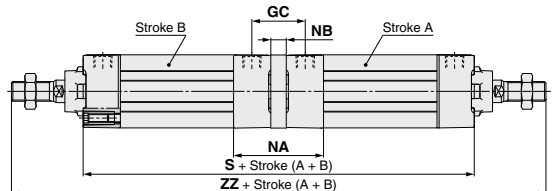

Made to Order Common Specifications: -XC10: Dual Stroke Cylinder/Double Rod Type



22 Dual Stroke Cylinder/Double Rod Type

Symbol
-XC10

Dimensions (Dimensions other than below are the same as standard type.)

CA2 series

Bore size	GB	Q	S	ZZ
40	29	53	167	269
50	33	59	179	295
63	33	61	195	311
80	41	73	231	373
100	41	79	251	395

(mm)

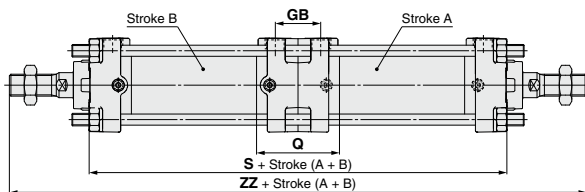

CBA2 series

Bore size (mm)	GC	L	Q	S	ZZ
40	42	12	66	180	282
50	48	14	74	194	310
63	48	14	76	210	326
80	58	16	90	248	390
100	60	18	98	270	414

(mm)

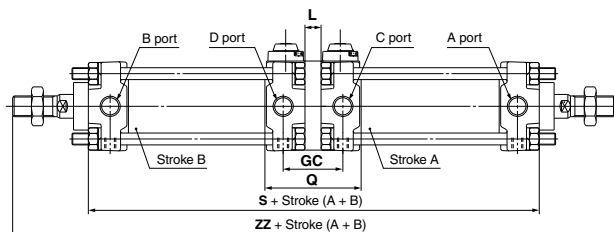

* The above diagram shows head side lock type and manual releasing non-locking type. Dimensions of rod side locking type, both-side lock type and manual releasing lock type are the same as dimensions in the above table.

CS1 series

Bore size (mm)	Without auto switch		With auto switch	
	S	ZZ	S	ZZ
125	196	416	196	416
140	196	416	196	416
160	212	452	212	452
180	222	492	230	500
200	222	492	240	510
250	282	602	—	—
300	292	642	—	—

(mm)

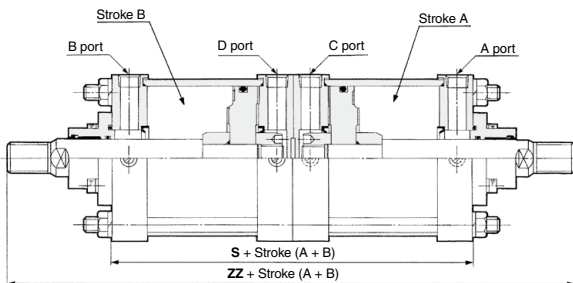

Made to Order Common Specifications: -XC10: Dual Stroke Cylinder/Double Rod Type



22 Dual Stroke Cylinder/Double Rod Type

Symbol
-XC10

Dimensions (Dimensions other than below are the same as standard type.)

CS2 series

* For rod side flange type "F", the flange bracket will be attached to the stroke A side.

ø125 to ø160

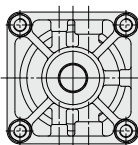
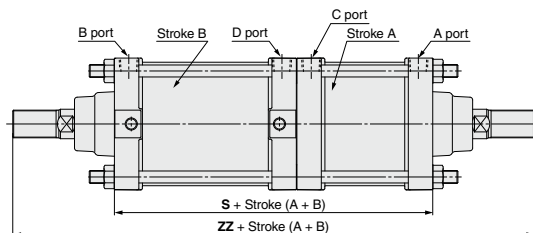

Bore size (mm)	(mm)	
	S	ZZ
125	196	416
140	196	416
160	212	452

ø180 to ø250

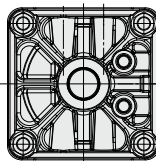
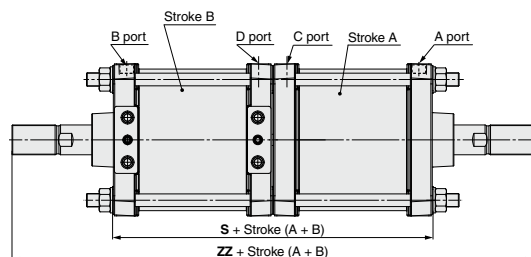

ø320

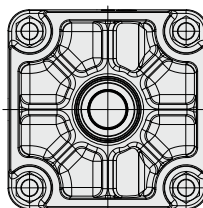
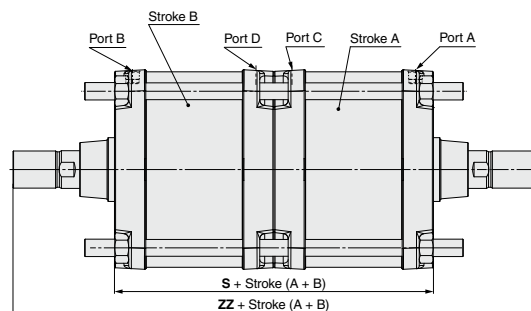

Bore size (mm)	(mm)	
	S	ZZ
180	230	500
200	240	510
250	282	602
320	350	700

Made to Order Common Specifications: -XC10: Dual Stroke Cylinder/Double Rod Type



22 Dual Stroke Cylinder/Double Rod Type

Symbol
-XC10

Dimensions (Other dimensions are the same as standard.)

CQ2 series

ø12 to ø25

With auto switch magnet

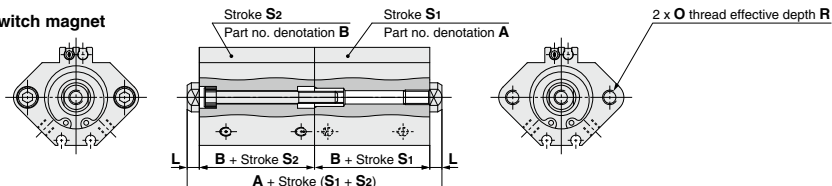

* In the case of bore sizes ø12 to ø25 with an auto switch, port directions are different.

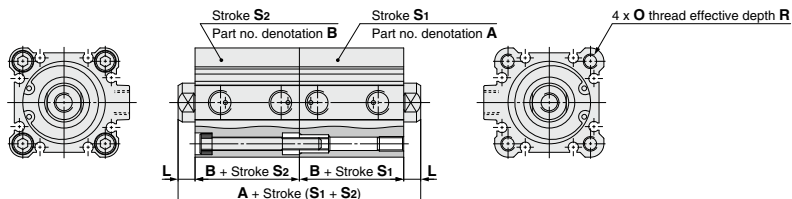

* Secure the body with the threaded portion at the tip of the piston rod on both sides or with the cylinder tube on the stroke S₁ side tapped.

* Please contact SMC for the through-hole type and models with a mounting bracket.

Bore size [mm]	A				B		L	O	R
	50 st or less for both S ₁ and S ₂	Combination of 50 st or less, 75, 100 st	75, 100 st for both S ₁ and S ₂	50 st or less	75, 100 st				
12	41 (63)	—	—	17 (28)	—	3.5	M4 x 0.7	7	
16	44 (68)	—	—	18.5 (30.5)	—	3.5	M4 x 0.7	7	
20	48 (72)	—	—	19.5 (31.5)	—	4.5	M6 x 1.0	10	
25	55 (75)	—	—	22.5 (32.5)	—	5	M6 x 1.0	10	
32	60 (80)	70 (80)	80 (80)	23 (33)	33 (33)	7	M6 x 1.0	10	
40	73 (93)	83 (93)	93 (93)	29.5 (39.5)	39.5 (39.5)	7	M6 x 1.0	10	
50	77 (97)	87 (97)	97 (97)	30.5 (40.5)	40.5 (40.5)	8	M8 x 1.25	14	
63	88 (108)	98 (108)	108 (108)	36 (46)	46 (46)	8	M10 x 1.5	18	
80	107 (127)	117 (127)	127 (127)	43.5 (53.5)	53.5 (53.5)	10	M12 x 1.75	22	
100	130 (150)	140 (150)	150 (150)	53 (63)	63 (63)	12	M12 x 1.75	22	

* () : Dimensions with auto switch

* Applicable stroke available in 5 mm increments

CQS series

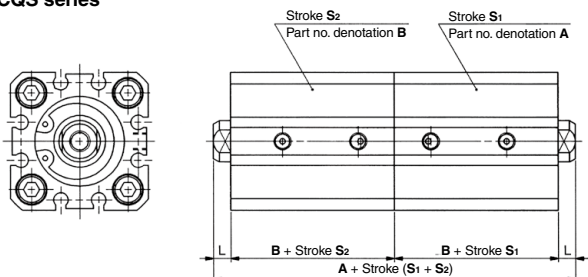

Bore size (mm)	(mm)			
	A	B	L	Stroke Both of S ₁ , S ₂
12	41 (51)	17 (22)	3.5	5 to 30
16	41 (51)	17 (22)	3.5	
20	48 (68)	19.5 (29.5)	4.5	5 to 50
25	55 (75)	22.5 (32.5)	5	

Note 1) () : Denotes the dimensions with auto switch.

Note 2) Applicable stroke available in 5 mm increments.

Made to Order Common Specifications: -XC11: Dual Stroke Cylinder/Single Rod Type



23 Dual Stroke Cylinder/Single Rod Type

Symbol
-XC11

Two cylinders can be integrated by connecting them in line, and the cylinder stroke can be controlled in two stages in both directions.
Do not operate the CS1 series at twice the output.

Applicable Series

Series	Description	Model	Action	Note	Vol. no. (for std model)
CJ2	Air cylinder	CJ2-Z	Double acting, Single rod	Except ø6 and with air cushion	Web Catalog
CM2	Air cylinder	CM2-Z	Double acting, Single rod		
	Non-rotating rod	CM2K-Z	Double acting, Single rod	Except with air cushion	
	Direct mount	CM2R-Z	Double acting, Single rod		
	Non-rotating rod, Direct mount type	CM2RK-Z	Double acting, Single rod		
CG1	Air cylinder	CG1-Z	Double acting, Single rod	Except ø80-100	
	Non-rotating rod	CG1K-Z	Double acting, Single rod	Except with air cushion	
MB	Air cylinder	MB-Z	Double acting, Single rod	* Except ø125 and trunnion type	
MB1	Air cylinder	MB1-Z	Double acting, Single rod	* Except ø125 and trunnion type	
CA2	Air cylinder	CA2-Z	Double acting, Single rod	* Except trunnion type	
	Non-rotating rod	CA2K	Double acting, Single rod	* Except trunnion type	
CS1	Air cylinder	CS1	Double acting, Single rod	* Except trunnion type	
CS2	Air cylinder	CS2	Double acting, Single rod	* Except trunnion type	
CQS	Compact cylinder	CQS	Double acting, Single rod	Except with bracket	
	Non-rotating rod type	CQSK	Double acting, Single rod	Except with bracket	
CQ2	Compact cylinder	CQ2-Z	Double acting, Single rod	Except with bracket	
	Non-rotating rod type	CQ2K-Z	Double acting, Single rod	Except with bracket	
	Air-hydro cylinder	CQ2H-Z	Double acting, Single rod	Except with bracket	
CNA2	Cylinder with lock	CNA2	Double acting, Single rod	* Except trunnion type	
MGG	Guide cylinder	MGG	Double acting		
MGC	Guide cylinder	MGC	Double acting		

How to Order

CJ2	Mounting type	Bore size	-	Stroke A	+	Stroke B-A	Z - XC11		
CM2	Mounting type	Bore size	-	Stroke A	+	Stroke B-A	Suffix Z - XC11		
CG1	Mounting type	Type	Bore size	-	Stroke A	+	Stroke B-A	Suffix Z - XC11	
MB MB1	Mounting type	Bore size	-	Stroke A	Suffix	+	Stroke B-A	Suffix Z - XC11	
* Except trunnion type									
CA2	Mounting type	Type	Bore size	-	Stroke A	Suffix	+	Stroke B-A	Suffix Z - XC11
* Except trunnion type									
CA2K	Mounting type	Type	Bore size	-	Stroke A	Suffix	+	Stroke B-A	Suffix - XC11
* Except trunnion type									
CS1	Mounting type	Tubing material	Bore size	-	Stroke A	Suffix	+	Stroke B-A	Suffix - XC11
* Except trunnion type									
CS2	Mounting type	Bore size	Port suffix	-	Stroke A	Suffix	+	Stroke B-A	Suffix - XC11
* Except trunnion type									
CQSB	Bore size	-	Stroke S ₁	+	Stroke S ₂ -S ₁	D(C)(M) - XC11			
CQ2B	Bore size	-	Stroke S ₁	+	Stroke S ₂ -S ₁	D(C)(M)(Z) - XC11			
CNA2	Mounting type	Type	Bore size	-	Stroke A	Suffix	+	Stroke B-A	Suffix - D - XC11

Dual stroke cylinder/Single rod ↓

Made to Order Common Specifications: -XC11: Dual Stroke Cylinder/Single Rod Type



23 Dual Stroke Cylinder/Single Rod Type

Symbol
-XC11

Specifications: The following models are the same as the standard type except for the specifications listed below.
(Please contact SMC for each manufacturable stroke length.)

CJ2

Bore size (mm)		10	16
Piston speed		The piston speed for the stroke B retraction side is 50 to 500 mm/s.	
Allowable kinetic energy	Stroke B (Retraction side)	0.015 J	0.040 J
Stroke tolerance		Stroke A: 0 to +2.0 mm, Stroke B is the same as that of the standard type.	
Specifications other than above		Same as standard type	



CM2

Bore size (mm)		20	25	32	40
Piston speed		The piston speed for the stroke B retraction side is 50 to 500 mm/s.			
Allowable kinetic energy	Stroke B (Retraction side)	0.12 J	0.18 J	0.28 J	0.53 J
Stroke tolerance		Stroke A: 0 to +2.0 mm, Stroke B is the same as that of the standard type.			
Specifications other than above		Same as standard type			

CG1

Bore size (mm)		20	25	32	40	50	63
Piston speed		The piston speed for the stroke B retraction side is 50 to 500 mm/s.					
Allowable kinetic energy	Stroke B (Retraction side)	0.07 J	0.1 J	0.16 J	0.3 J	0.5 J	0.85 J
Specifications other than above		Same as standard type					

Precautions

⚠ Caution

- Do not supply air until the cylinder is fixed with the attached bolt.
- If air is supplied without securing the cylinder, the cylinder could lurch, posing the risk of bodily injury or damage to the peripheral equipment.

Functional description of dual stroke cylinder

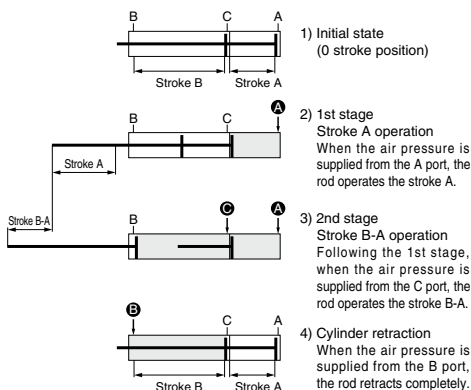

Stroke A or stroke B operation can be made individually.

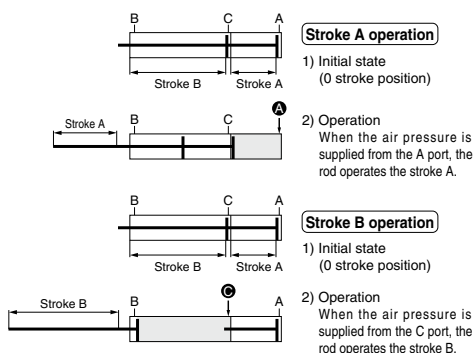

Double output is possible.

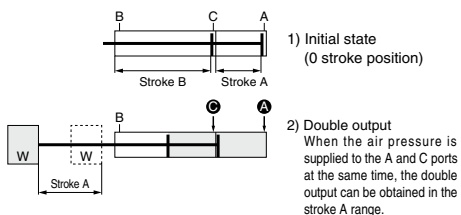

Made to Order Common Specifications: -XC11: Dual Stroke Cylinder/Single Rod Type



23 Dual Stroke Cylinder/Single Rod Type

Symbol
-XC11

Dimensions (Dimensions other than below are the same as standard type.)

CJ2 series

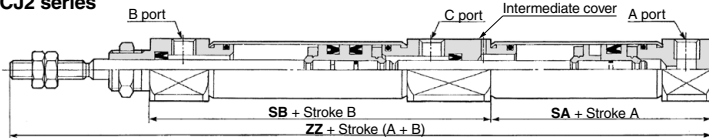

(mm)			
Bore size (mm)	SA	SB	Z
10	31	53.5	112.5
16	31.5	54.5	114

Note) When mounting an auto switch at the extended piston rod A side, the following auto switches interfere with the intermediate cover. In this case, please mount on the stroke B side. Please be aware that the auto switch defects and temporarily turns ON/OFF when passing the intermediate position of the B stroke.

Solid state auto switch : D-H7□, D-H7C, D-H7□W, D-H7NF, D-H7BA

Reed auto switch : D-C7□, D-C80, D-C73C, D-C80C, D-A80, D-A9□, D-A9□V, D-A79W, D-A73

CM2 series

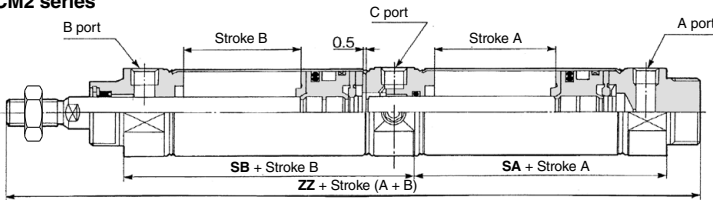

(mm)			
Bore size (mm)	SA	SB	ZZ
20	48	62	164
25	48	62	168
32	50	64	172
40	67.5	88.5	222

CM2R series

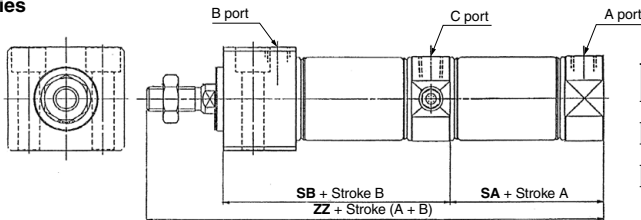

(mm)			
Bore size (mm)	SA	SB	ZZ
20	48	76	151
25	48	76	155
32	50	78	159
40	67.5	104.5	206

CG1 series

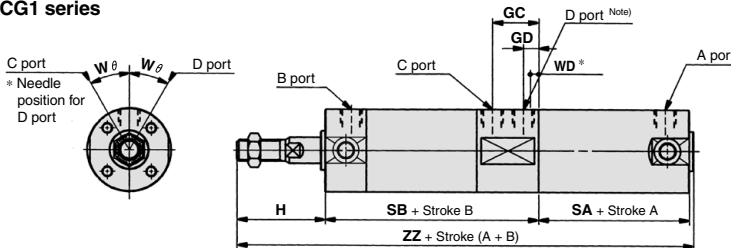

Note) D port type Type N: Rubber bumper, Plug with fixed orifice;

Type A: Air cushion, element non-installation (Release to atmospheric pressure)

CG1, CG1K

(mm)										
Bore size	GC	GD	H	SA	SB	Wθ	ZZ	Air cushion		Long stroke
								WD	SA	ZZ
20	21	9	35	48	87	30°	172	5	56	180
25	21 (21.5)	9 (8.5)	40	48	87	30°	177	6.5	56	185
32	23	9	40	50	91	30°	183	5	58	191
40	25	9	50	56	100	20°	208	5	65	217
50	29	13	58	63	118	20°	241	9	75	253
63	28	12	58	64	117	20°	241	8	76	253

* () : With air cushion

Note) When the stroke A is a long stroke (ø20: 201 mm or more, ø25 to ø63: 301 mm or more)

Made to Order Common Specifications: -XC11: Dual Stroke Cylinder/Single Rod Type



23 Dual Stroke Cylinder/Single Rod Type

Symbol
-XC11

Construction/Dimensions

MB series

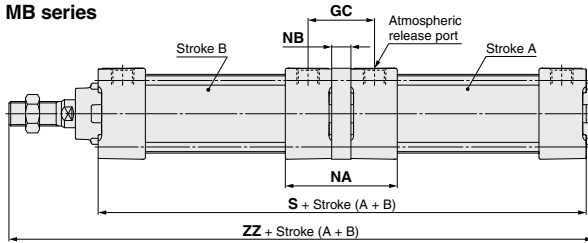

(mm)					
Bore size	GC	NA	NB	S	ZZ
32	36	64	10.6	179	230
40	38	64	10.6	179	234
50	41	73	10.6	199	261
63	43	73	10.6	199	261
80	52	90	14.6	243	319
100	52	90	14.6	243	319

MB1 series

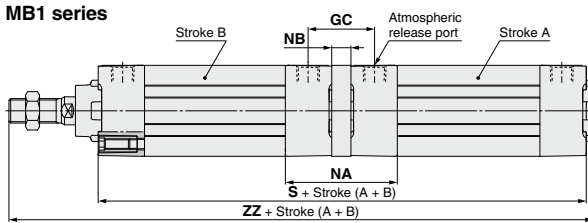

(mm)					
Bore size	GC	NA	NB	S	ZZ
32	36	62	10.6	179	230
40	38	62	10.6	179	234
50	41	71	10.6	199	261
63	43	71	10.6	199	261
80	52	88	14.6	243	319
100	52	88	14.6	243	319

CA2 series

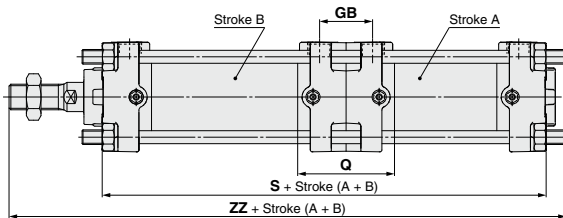

(mm)				
Bore size	GB	Q	S	ZZ
40	29	53	168	230
50	33	59	180	249
63	33	61	196	268
80	41	73	232	320
100	41	79	252	341

CNA2 series

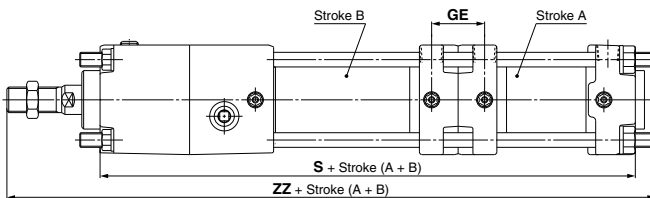

(mm)			
Bore size	GE	S	ZZ
40	29	237	299
50	33	258	327
63	33	280	352
80	41	334	422
100	41	372	461

Made to Order Common Specifications: -XC11: Dual Stroke Cylinder/Single Rod Type



23 Dual Stroke Cylinder/Single Rod Type

Symbol
-XC11

Construction/Dimensions

CS1 series

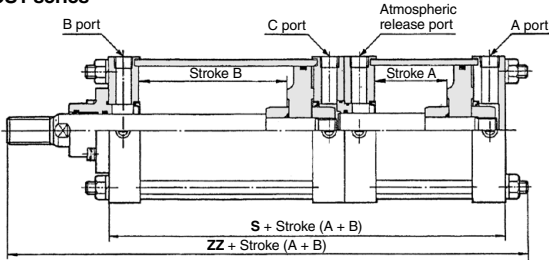

Bore size (mm)	Without auto switch		With auto switch	
	S	ZZ	S	ZZ
125	197	334	197	334
140	197	334	197	334
160	213	363.5	213	363.5
180	223	393	231	401
200	223	393	241	411
250	283	484.5	—	—
300	293	519.5	—	—

CS2 series

ø125 to ø160

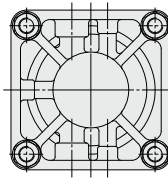
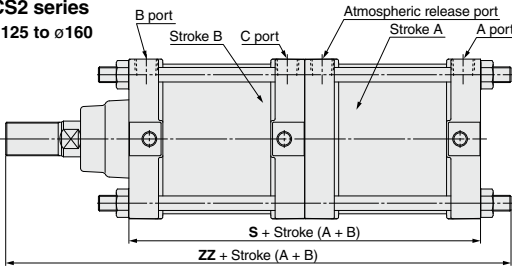

Bore size (mm)	S		ZZ	
	S	ZZ	S	ZZ
125	197	334	197	334
140	197	334	197	334
160	213	363.5	213	363.5

ø180 to ø250

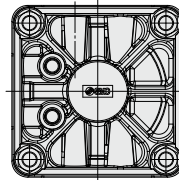
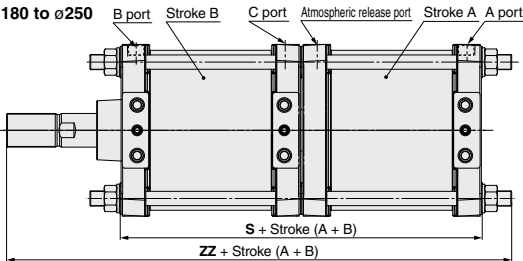

Bore size (mm)	S		ZZ	
	S	ZZ	S	ZZ
180	231	401	231	401
200	241	411	241	411
250	283	484.5	283	484.5
320	351	577.5	351	577.5

ø320

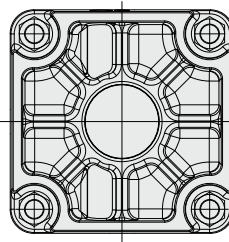
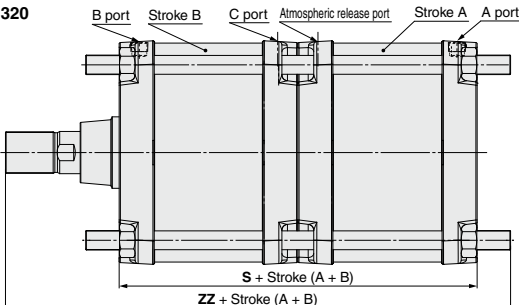

Made to Order Common Specifications: -XC11: Dual Stroke Cylinder/Single Rod Type



22 Dual Stroke Cylinder/Double Rod Type

Symbol
-XC11

CQS series

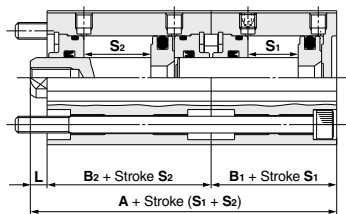

Bore size (mm)	(mm)					Stroke Both of S ₁ & S ₂
	A	B ₁	B ₂	L		
12	42.5 (52.5)	17 (22)	22 (27)	3.5		5 to 30
16	42.5 (52.5)	17 (22)	22 (27)	3.5		
20	50 (70)	19.5 (29.5)	26 (36)	4.5		5 to 50
25	56.5 (76.5)	22.5 (32.5)	29 (39)	5		

Note 1 () : Denotes the dimensions with auto switch.
 Note 2) Applicable stroke available in 5 mm increments.
 Note 3) Please contact SMC for long stroke type.

CQ2 series

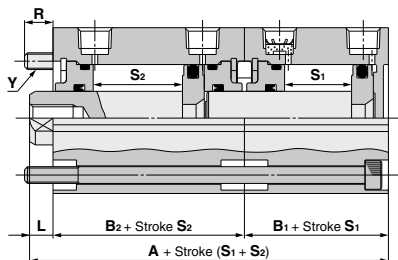

Bore size (mm)	(mm)							Stroke Both S ₁ and S ₂
	A	B ₁	B ₂	L	R	Y		
12	45.7 (63.9)	17 (28)	25.2 (32.4)	3.5	8.3 (8.1)	M3 x 0.5	5 to 30	
16	48 (70)	18.5 (30.5)	26 (36)	3.5	9 (7)			
20	50 (74)	19.5 (31.5)	26 (38)	4.5	11.5 (7.5)	M5 x 0.8	5 to 50	
25	56.5 (76.5)	22.5 (32.5)	29 (39)	5	10.5			
32	60.5 (80.5)	23 (33)	30.5 (40.5)	7	8.5	M6 x 1	10 to 50	
40	76.5 (96.5)	29.5 (39.5)	40 (50)	7	7.5			
50	79 (99)	30.5 (40.5)	40.5 (50.5)	8	12	M8 x 1.25	10 to 50	
63	86 (106)	36 (46)	42 (52)	8	12.5			
80	104.5 (124.5)	43.5 (53.5)	51 (61)	10	19	M10 x 1.5	10 to 50	
100	125.5 (145.5)	53 (63)	60.5 (70.5)	12	15			

* () : Dimensions with auto switch magnet
 * Applicable stroke available in 5 mm increments
 * Please contact SMC for long stroke type.

Precautions

⚠ Caution

1. Remove the temporary fixing nut and flat washer from the mounting bolt, and secure the cylinder properly with the mounting bolt.
2. Although the cylinder can be detached by removing the nut, do not detach it for purposes other than replacing the seal.
3. The removed nut and flat washer are not used to secure the body.

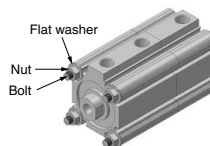

Made to Order Common Specifications: -XC11: Dual Stroke Cylinder/Single Rod Type



23 Dual Stroke Cylinder/Single Rod Type

Symbol
-XC11

MGG series

How to Order

MGG Bearing type Mounting type Bore size - Stroke A + Stroke B-A - Auto switch - **XC11**

Dual stroke cylinder/Single rod type

Specifications

Bore size	20	25	32	40	50	63
Basic cylinder	$\phi 20$ to $\phi 50$: CDG1ZN <input type="text"/> Bore size - <input type="text"/> Stroke A + <input type="text"/> Stroke B-A Z - <input type="text"/> Auto switch - X428 $\phi 63$: CDG1ZN <input type="text"/> Bore size - <input type="text"/> Stroke A + <input type="text"/> Stroke B-A Z - <input type="text"/> Auto switch - XC11					
Dimensions	Refer to the table below.					
Piston speed	The piston speed for the stroke B retraction side is 50 to 500 mm/s.					
Specifications other than above	Same as standard type					

Dimensions (Dimensions other than below are the same as standard type.)

MGG series
 $\phi 20$ to $\phi 50$

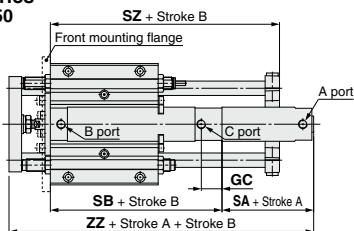

MGG Series

Bore size (mm)	GC	SA	SB	SZ	ZZ	Bracket mounting stroke (Stroke A + Stroke B)	Long stroke ^{Note}	
							SA	ZZ
20	21	50	87	118	176	35 st or more	58	184
25	21	50	87	129	183	60 st or more	58	191
32	23	52	91	155	189	80 st or more	60	197
40	25	58	100	182	214	125 st or more	67	223
50	29	65	118	218	250	160 st or more	77	262
63	28	66	132	254	252	210 st or more	78	264

Note) When the stroke A is a long stroke ($\phi 20$: 201 mm or more, $\phi 25$ to $\phi 63$: 301 mm or more)

$\phi 63$

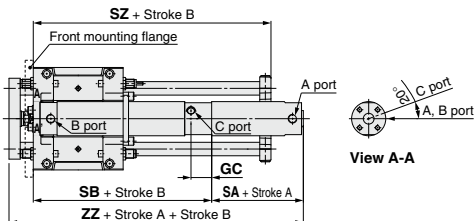

Made to Order Common Specifications: -XC11: Dual Stroke Cylinder/Single Rod Type



23 Dual Stroke Cylinder/Single Rod Type

Symbol
-XC11

MGG series

How to Order

MGC Bearing type Mounting type Bore size - Stroke A + Stroke B-A - Equipped/Not equipped back plate - Auto switch -XC11

Dual stroke cylinder/Single rod type

Specifications

Bore size	20	25	32	40	50
Basic cylinder	CDG1ZA <input type="text"/> Bore size <input type="text"/> - <input type="text"/> Stroke A <input type="text"/> + <input type="text"/> Stroke B-A <input type="text"/> Z - <input type="text"/> Auto switch <input type="text"/> -XC11				
Dimensions	Refer to the table below.				
Piston speed	The piston speed for the stroke B retraction side is 50 to 500 mm/s.				
Specifications other than above	Same as standard type				

Dimensions (Dimensions other than below are the same as standard type.)

MGC series

ø20 to ø50

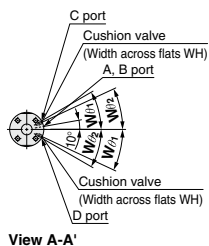
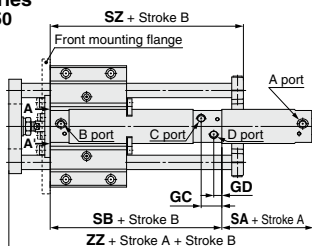

MGC Series

(mm)

Bore size (mm)	GC	GD	SA	SB	W ₁	W ₂	Long stroke ^{Note}	
							SA	ZZ
20	21	9	50	87	25°	30°	58	184
25	21.5	8.5	50	87	25°	30°	58	191
32	23	9	52	91	25°	30°	60	197
40	25	9	58	100	20°	20°	67	223
50	29	13	65	118	20°	20°	77	262

Bore size (mm)	SZ		ZZ	Bracket mounting stroke (Stroke A + Stroke B)
	With R	Without R		
20	101	80	176	35 st or more
25	107	85	183	60 st or more
32	115	90	189	80 st or more
40	132	100	214	125 st or more
50	174	135	250	160 st or more

Note) When the stroke A is a long stroke (ø20: 201 mm or more, ø25 to ø50: 301 mm or more)

Made to Order Common Specifications: -XC12: Tandem Cylinder



24 Tandem Cylinder

Symbol
-XC12

This is a cylinder produced with two air cylinders in line allowing double the output force.

Applicable Series

Series	Description	Model	Action	Note	Vol. no. (for std model)
CM2	Air cylinder	CM2-Z	Double acting, Single rod	Except with air cushion	Web Catalog
	Direct mount type	CM2R	Double acting, Single rod	Except with air cushion	
CG1	Air cylinder	CG1-Z	Double acting, Single rod	Except with air cushion	
	Non-rotating rod type	CG1K-Z	Double acting, Single rod	Except with air cushion	
MB	Air cylinder	MB-Z	Double acting, Single rod	Except ø125	
MB1	Air cylinder	MB1-Z	Double acting, Single rod	Except ø125	
CA2	Air cylinder	CA2-Z	Double acting, Single rod		

How to Order

Standard model no. **-XC12**
Tandem cylinder



CG1 series

Symbol

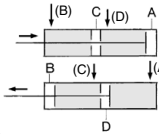

When air pressure is supplied to ports (B) and (D), the output force is doubled in the retract stroke.

When air pressure is supplied to ports (A) and (C), the output force is doubled in the out stroke.

Specifications: Same as standard type

Dimensions (Dimensions other than below are the same as standard type.)

CM2 series

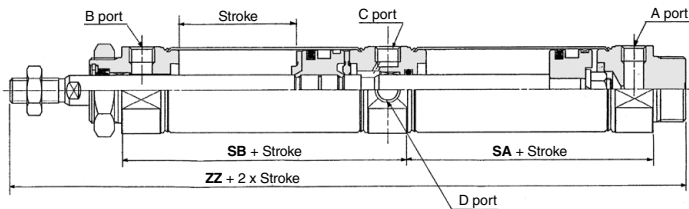

(mm)			
Bore size	SA	SB	ZZ
20	48	62	164
25	48	62	168
32	50	64	172
40	67.5	88.5	222

Made to Order Common Specifications: -XC12: Tandem Cylinder



24 Tandem Cylinder

Symbol
-XC12

Dimensions (Dimensions other than below are the same as standard type.)

CG1 series

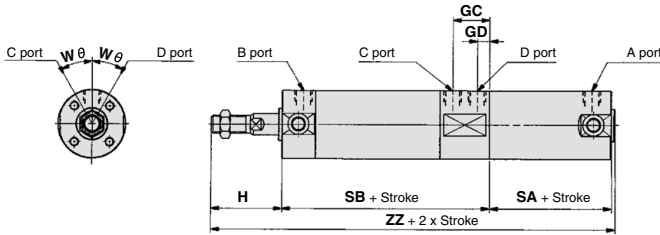

CG1

Bore size	GC	GD	H	SA	SB	W θ	ZZ	(mm)	
								Long stroke	Note)
								SA	ZZ
20	21	9	35	48	87	30°	172	56	180
25	21	9	40	48	87	30°	177	56	185
32	23	9	40	50	91	30°	183	58	191
40	25	9	50	56	100	20°	208	65	217
50	29	13	58	63	118	20°	241	75	253
63	28	12	58	64	117	20°	241	76	253

Note) When the stroke is a long stroke ($\phi 20$: 201 mm or more, $\phi 25$ to $\phi 63$: 301 mm or more)

CG1K

Bore size	GC	GD	H	SA	SB	W θ	ZZ	(mm)	
								Long stroke	Note)
								SA	ZZ
20	21	9	35	48	87	30°	172	56	180
25	21	9	40	48	87	30°	177	56	185
32	23	9	40	50	91	30°	183	58	191
40	24	8	50	57	99	20°	208	65	217
50	28	12	58	64	117	20°	241	75	253
63	28	12	58	64	117	20°	241	76	253

* Please contact SMC for long stroke (301 mm or more) since SA-dimensions and ZZ-dimensions are different from those in the above table.

CA2 series

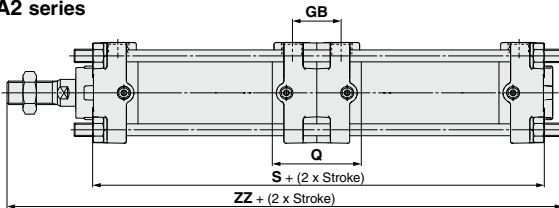

Bore size	GB	Q	S	ZZ	(mm)	
					Long stroke	Note)
40	29	53	169	231	65	217
50	33	59	181	250	75	253
63	33	61	197	269	76	253
80	41	73	233	321	86	299
100	41	79	253	342	86	299

MB series

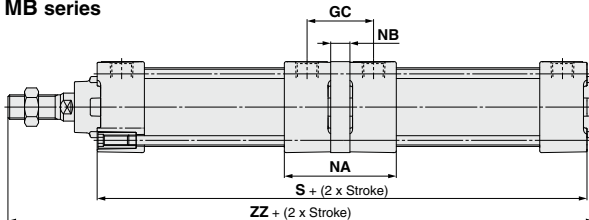

Bore size	GC	NA	NB	S	ZZ	(mm)	
						Long stroke	Note)
32	36	64	10.6	180	231	65	217
40	38	64	10.6	180	235	65	217
50	41	73	10.6	200	262	75	253
63	43	73	10.6	200	262	75	253
80	52	90	14.6	244	320	86	299
100	52	90	14.6	244	320	86	299

MB1 series

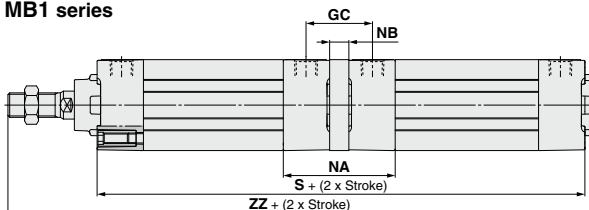

Bore size	GC	NA	NB	S	ZZ	(mm)	
						Long stroke	Note)
32	36	62	10.6	180	231	65	217
40	38	62	10.6	180	235	65	217
50	41	71	10.6	200	262	75	253
63	43	71	10.6	200	262	75	253
80	52	88	14.6	244	320	86	299
100	52	88	14.6	244	320	86	299

Made to Order Common Specifications: -XC13: Auto Switch Rail Mounting Type



25 Auto Switch Rail Mounting Type

Symbol
-XC13

A cylinder on which a rail is mounted to enable auto switches, in addition to the standard method for mounting auto switches (Band mounting type).

Applicable Series

Series	Description	Model	Action	Note	Vol. no. (for std model)
CM2	Air cylinder	CM2-Z	Double acting, Single rod Single acting (Spring return/extend)		Web Catalog
		CM2W-Z	Double acting, Double rod		
	Non-rotating rod type	CM2K-Z	Double acting, Single rod Single acting (Spring return/extend)		
		CM2KW	Double acting, Double rod		
		Direct mount type	CM2R-Z	Double acting, Single rod	
	Non-rotating rod, Direct mount type	CM2RK-Z	Double acting, Single rod		
	Smooth cylinder	CM2Y-Z	Double acting, Single rod		
End lock cylinder	CBM2	Double acting, Single rod	For XC13A and XC13C only		
CG1	Air cylinder	CG1-Z	Double acting, Single rod	Except the trunnion type	
	Double rod type	CG1W-Z	Double acting, Double rod	Except the trunnion type	
	Non-rotating rod type	CG1K-Z	Double acting, Single rod	Except the trunnion type	
	Direct mount type	CG1R-Z	Double acting, Single rod	Except with air cushion	
	End lock cylinder	CBG1	Double acting, Single rod	For XC13A only	
MGG	Guide cylinder	MGG	Double acting		
MGC	Guide cylinder	MGC	Double acting		

How to Order

CDM2 - XC13A

CDG1 - XC13A

* Trunnion type of the CDG1 series cannot be mounted.

Rail mounting direction *

XC13A	Mounted on the right side when viewed from the rod with the ports facing upwards.
XC13B ^{*2, *3}	Mounted on the left side when viewed from the rod.
XC13C ^{*1, *2}	Mounted on the underside when viewed from the rod.

- * 1 Not available for CDG1.
- * 2 Not available for CBG1.
- * 3 Not available for CBM2.

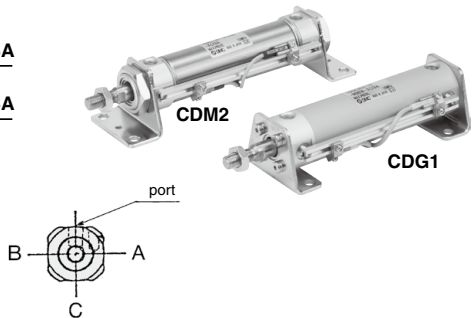

CDM2 Applicable Auto Switches

Rail mounting type	Solid state	D-F7□, D-F7□V, D-F7BA, D-F79F, D-F79W, D-F7□WV, D-J79, D-J79C, D-J79W
	Reed	D-A9□/A9□V, D-A7/A8, D-A7□H/A80H, D-A73C/A80C, D-A79W
Auto switch specifications		For detailed specifications about an auto switch for itself, refer to pages 1289 to 1383.

CDG1 Applicable Auto Switches

Rail mounting type	Solid state	D-M9□/M9□V, D-M9□W/M9□WV, D-M9□A/M9□AV, D-F7□, D-F7□V, D-F7BA, D-F79F, D-F79W, D-F7□WV, D-J79, D-J79C, D-J79W
	Reed	D-A7/A8, D-A7□H/A80H, D-A73C/A80C, D-A79W
Auto switch specifications		For detailed specifications about an auto switch for itself, refer to pages 1289 to 1383.

Made to Order Common Specifications: -XC13: Auto Switch Rail Mounting Type



25 Auto Switch Rail Mounting Type

Symbol
-XC13

Proper Auto Switch Mounting Position (Detection at stroke end) and Mounting Height

CDM2 series

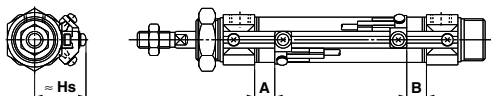

Proper Auto Switch Mounting Position (mm)

Auto switch model Bore size (mm)	D-F7NT		D-A9□ D-A9□V D-A79W		D-A7□ D-A80	
	A	B	A	B	A	B
20	8 (5.5)	7 (4.5)	13 (10.5)	12 (9.5)	5 (2.5)	4 (1.5)
25	8 (5.5)	7 (4.5)	13 (10.5)	12 (9.5)	5 (2.5)	4 (1.5)
32	9 (6.5)	8 (5.5)	14 (11.5)	13 (10.5)	6 (3.5)	5 (2.5)
40	15	13	19	18	12	10

Auto Switch Mounting Height (mm)

D-F7□/F79F D-J79/F7NT D-F7□W/J79W D-F7BA D-A9□/A9□V A7□/A80H	D-F7□V D-F7BAV	D-J79C	D-A7□ D-A80	D-A73C D-A80C	D-A79W
Hs	Hs	Hs	Hs	Hs	Hs
23.5	26	29	22.5	29.5	25
26.5	29	32	25.5	32.5	28
30	32.5	35.5	29	35	31.5
34	36.5	39.5	33	40	35.5

Note 1) (): With air cushion

Note 2) Adjust the auto switch after confirming the operating conditions in the actual setting.

Note 3) For the dimensions other than the proper auto switch mounting position and its mounting height, refer to standard type for CM2 series.

Minimum Auto Switch Mounting Stroke (mm)

Auto switch model	No. of auto switch mounted		
	1	2 Same surface	n (n: No. of auto switches) Same surface
D-F7□V D-J79C	5	5	10 + 10 (n-2) ^{Note} (n=4, 6···)
D-F7□ D-J79	5	5	15 + 15 (n-2) ^{Note} (n=4, 6···)
D-F7□WV D-F7BAV D-A79W	10	15	10 + 15 (n-2) ^{Note} (n=4, 6···)
D-F7□W/J79W D-F7BA D-F79F/F7NT	10	15	15 + 20 (n-2) ^{Note} (n=4, 6···)
D-A9□ D-A9□V	5	10	10 + 15 (n-2) ^{Note} (n=4, 6···)
D-A7□/A80 D-A7□H/A80H D-A73C/A80C	5	10	15 + 10 (n-2) ^{Note} (n=4, 6···)
D-A7□H D-A80H	5	10	15 + 15 (n-2) ^{Note} (n=4, 6···)

Note) When "n" is an odd number, an even number that is one larger than this odd number is used for the calculation. However, the minimum even number is 4. So, 4 is used for the calculation when "n" is 1 to 3.

Auto Switch Mounting Bracket: Part No.

Auto switch model	Bore size (mm)
	D-A9□/A9□V

Note 1) When adding D-A9□(V), order a set of auto switch mounting brackets BQ-1 and BQ2-012 for the CDQ2 series (ø12 to ø25) separately.

When adding the auto switches other than D-A9□(V) mentioned on the left and D-F7BA(V), order auto switch mounting brackets BQ-1 separately.

Note 2) When adding the auto switch D-F7BA(V), order a stainless steel screw set BBA2 separately.

Operating range (mm)

Auto switch model	Bore size (mm)			
	20	25	32	40
D-F7□/F79F/F7□V D-J79/J79C D-F7□W/J79W/F7□WV D-F7BA/F7BAV D-F7NTL	3.5	3.5	4	3.5
D-A9□/D-A9□V	5.5	6	6.5	6.5
D-A7□/A80 D-A7□H/A80H D-A73C/A80C	7.5	8	8.5	8.5
D-A79W	10	10.5	12.5	12.5

* Since the operating range is provided as a guideline including hysteresis, it cannot be guaranteed (assuming approximately ±30% dispersion). It may vary substantially depending on an ambient environment.

Made to Order Common Specifications: -XC13: Auto Switch Rail Mounting Type



25 Auto Switch Rail Mounting Type

Symbol
-XC13

Proper Auto Switch Mounting Position (Detection at stroke end) and Mounting Height

CDG1 series

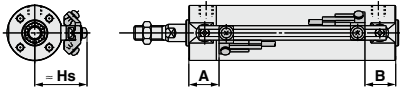

CDG1R series (ø20 to ø63)

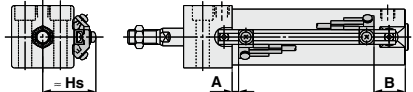

Proper Auto Switch Mounting Position (Detection at stroke end)

Applicable Cylinder Series: CDG1-XC13

(mm)

Auto switch model	D-M9□/D-M9□V D-M9□W/D-M9□WV D-M9□A/D-M9□AV		D-F7□/F79F□V D-J79/J79C D-F7□W/J79W/F7□WV		D-F7A/F7ABV D-A72/A7□H/A80H D-A73C/A80C		D-F7NT		D-A7□ D-A80		D-A79W	
	A	B	A	B	A	B	A	B	A	B	A	B
20	31.5	22.5 (30.5)	30.5	21.5 (29.5)	35.5	26.5 (34.5)	30	21 (29)	27.5	18.5 (26.5)		
25	31	23 (31)	30	22 (30)	35	27 (35)	29.5	21.5 (29.5)	27	19 (27)		
32	32.5	23.5 (31.5)	31.5	22.5 (30.5)	36.5	27.5 (35.5)	31	22 (30)	28.5	19.5 (27.5)		
40	37.5	25.5 (34.5)	36.5	24.5 (33.5)	41.5	29.5 (38.5)	36	24 (33)	33.5	21.5 (30.5)		
50	44.5	30.5 (42.5)	43.5	29.5 (41.5)	49	34.5 (46.5)	43	29 (41)	40.5	26.5 (38.5)		
63	43	32 (44)	42	31 (43)	47	36 (48)	41.5	30.5 (42.5)	39	28 (40)		
80	56	37 (51)	55	36 (50)	60	41 (55)	54.5	35.5 (49.5)	52	33 (47)		
100	55	38 (52)	54	37 (51)	59	42 (56)	53.5	36.5 (50.5)	51	34 (48)		

Note 1) (): For long stroke type

Note 2) Adjust the auto switch after confirming the operating conditions in the actual setting.

Proper Auto Switch Mounting Position (Detection at stroke end)

Applicable Cylinder Series: CDG1R-XC13

(mm)

Auto switch model	D-M9□/D-M9□V D-M9□W/D-M9□WV D-M9□A/D-M9□AV		D-F7□/F79F□V D-J79/J79C D-F7□W/J79W/F7□WV		D-F7A/F7ABV D-A72/A7□H/A80H D-A73C/A80C		D-F7NT		D-A7□ D-A80		D-A79W	
	A	B	A	B	A	B	A	B	A	B	A	B
20	10.5	22.5	9.5	21.5	14.5	26.5	9	21	6.5	18.5		
25	10	23	9	22	14	27	8.5	21.5	6	19		
32	11.5	23.5	10.5	22.5	15.5	27.5	10	22	7.5	19.5		
40	16.5	25.5	15.5	24.5	20.5	29.5	15	24	12.5	21.5		
50	18.5	30.5	17.5	29.5	22.5	34.5	17	29	14.5	26.5		
63	17	32	16	31	21	36	15.5	30.5	13	28		

Note) Adjust the auto switch after confirming the operating conditions in the actual setting.

Proper Auto Switch Mounting Position/Applicable Cylinder Series: CDBG1-XC13 (mm)

Lock position	H (Head side)		R (Rod side)		W (Both sides)	
	A	B (Note 2)	A	B	A	B (Note 2)
20	+0	+12	+11	+0	+11	+12
25	+0.5	+11.5	+11.5	-0.5	+11.5	+11.5
32	+0	+10	+10	+0	+10	+10
40	+0	+14	+9	+0	+9	+14
50	+0	+17	+12	+0	+12	+17
63	+1.5	+15.5	+13.5	-1.5	+13.5	+15.5
80	-1.5	+23.5	+14.5	+1.5	+14.5	+23.5
100	-0.5	+23.5	+15.5	+0.5	+15.5	+22.5

Note 1) For end lock cylinders, add the above values to those listed in the table for CG1-XC13.

Note 2) For the head side and both sides lock, add the above values to CG1-XC13 (long stroke) to find B.

Note 3) Adjust the auto switch after confirming the operating conditions in the actual setting.

Note 4) For the dimensions other than the proper auto switch mounting position and mounting height, refer to standard type for CDBG1 series.

Auto Switch Mounting Height

(mm)

Auto switch model	D-M9□/M9□V D-M9□W/M9□WV D-F7□/F79F D-J79/F7NT D-F7□W/J79W/F7B	D-F7□V D-F7□WV D-F7BAV	D-J79C	D-A7□ D-A80	D-A73C D-A80C	D-A79W
	Hs	Hs	Hs	Hs	Hs	Hs
20	26.5	29	32	25.5	32.5	28
25	29	31.5	34.5	28	35	30.5
32	32.5	35	38	31.5	38.5	34
40	36.5	39	42	35.5	42.5	38
50	42	44.5	47.5	41	48	43.5
63	49	51.5	54.5	48	55	50.5
80	59	61.5	64.5	58	65	60.5
100	69.5	72	75	68.5	75.5	71

Made to Order Common Specifications: -XC13: Auto Switch Rail Mounting Type



25 Auto Switch Rail Mounting Type

Symbol
-XC13

How to Order

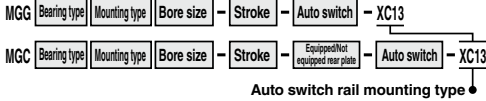

MGG/MGC Applicable Auto Switches

Rail mounting type	Solid state switch	
		D-M9□/M9□V, D-M9□W/M9□WV, D-M9□A/M9□AV, D-F7□, D-F7□V, D-F7BA, D-F79F, D-F79W, D-F7□WV, D-J79, D-J79C, D-J79W
Auto switch specifications	Reed switch	
		D-A7/A8, D-A7□/A80H, D-A73C/A80C, D-A79W
For detailed specifications about an auto switch for itself, refer to pages 1289 to 1383.		

Dimensions (Dimensions other than below are the same as standard type.)

MGG series ø20 to ø50

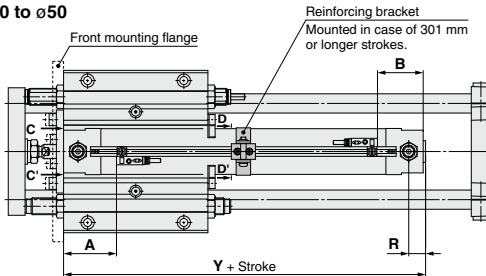

Width across flats HT



View C-C'



View D-D'

MGG Series (mm)

Bore size (mm)	R	Y	HS	HT	HU
20	14	99	28.5	14	30.7
25	14	99	31	14	33.2
32	14	101	34.5	14	36.5
40	15	109	39	14	41
50	16	124	49.5	17	46.2
63	16	139	56.5	17	53.2
80	23	165	75.5	23	62.2
100	23	165	86	26	72.7

ø63 to ø100

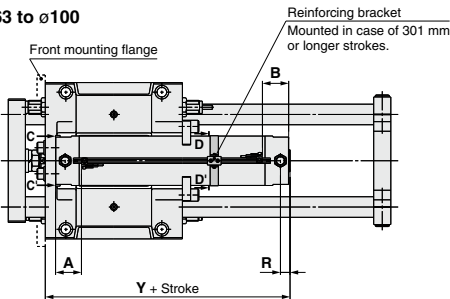

Width across flats HT



View C-C'



View D-D'

MGC Series (mm)

Bore size (mm)	R	Y	HS	HT	HU
20	14	99	26	7	30.7
25	14	99	28.5	7	33.2
32	14	101	34.5	14	36.5
40	15	109	39	14	41
50	16	124	49.5	17	46.2

MGC series ø20 to ø50

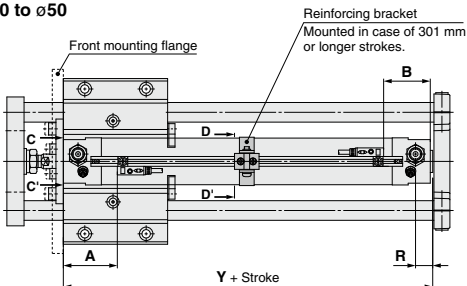

Width across flats HT



View C-C'



View D-D'

Made to Order Common Specifications: -XC13: Auto Switch Rail Mounting Type



25 Auto Switch Rail Mounting Type

Symbol
-XC13

Proper Auto Switch Mounting Position (Detection at stroke end) and Mounting Height

Proper Auto Switch Mounting Position/Applicable Cylinder MGG, MGC Series (mm)

Auto switch model	D-M9□/M9□V D-M9□W/M9□VV D-M9□A/M9□AV		D-F7□/F79F/F7□V D-J79/J79C D-F7□W/J79W/F7□VV D-F7BA/F7BAV D-A72/A7□H/A80H D-A73C/A80C		D-F7NT		D-A7□ D-A80		D-A79W	
	A	B	A	B	A	B	A	B	A	B
	Bore size (mm)									
20	45.5	39.5	43	37	48	42	42.5	36.5	40	34
25	45.5	39.5	43	37	48	42	42.5	36.5	40	34
32	46.5	40.5	44	38	49	43	43.5	37.5	41	35
40	51.5	43.5	49	41	54	46	48.5	40.5	46	38
50	58.5	51.5	56	49	61	54	55.5	48.5	53	46
63	58.5	51.5	56	49	61	54	55.5	48.5	53	46
80	68.5	61.5	66	59	71	64	65.5	58.5	63	56
100	68.5	61.5	66	59	71	64	65.5	58.5	63	56

Auto Switch Mounting Height (mm)

D-M9□/M9□V D-M9□W/M9□VV D-M9□A/M9□AV		D-F7□V D-F7□VV D-F7BAV	D-J79C	D-A7□ D-A80	D-A73C D-A80C	D-A79W
Hs		Hs	Hs	Hs	Hs	Hs
26.5		29	31	26.5	32.5	30
29		31.5	33.5	29	35	32.5
32.5		34.5	36.5	32	38.5	35.5
37		39	41	36.5	43	40
42		44.5	46.5	42	48	45.5
49		51.5	53.5	49	55	52.5
58		60.5	62.5	58	64	61.5
69		71	73	68.5	74.5	72

Note 1) Adjust the auto switch after confirming the operating conditions in the actual setting.

Note 2) For dimensions other than the proper auto switch mounting position and height, refer the standard type for MGG and MGC series.

Minimum Auto Switch Mounting Stroke/CDG1, MGG, MGC

Auto switch model	No. of auto switch mounted (mm)		
	1	2 Same surface	n (n: No. of auto switches) Same surface
D-M9□/M9□V D-F7□V D-J79C	5	5	10 + 10 (n-2) ^{Note)} (n=4, 6···)
D-M9□VV D-M9□AV D-F7□VV D-F7BAV D-A79W	10	15	10 + 15 (n-2) ^{Note)} (n=4, 6···)
D-M9□W D-M9□A	10	15	15 + 15 (n-2) ^{Note)} (n=4, 6···)
D-F7□ D-J79	5	5	15 + 15 (n-2) ^{Note)} (n=4, 6···)
D-F7□W/J79W D-F7BA D-F79F/F7NT	10	15	15 + 20 (n-2) ^{Note)} (n=4, 6···)
D-A7□/A80 D-A7□H/A80H D-A73C/A80C	5	10	15 + 10 (n-2) ^{Note)} (n=4, 6···)
D-A7□H D-A80H	5	10	15 + 15 (n-2) ^{Note)} (n=4, 6···)

Note) When "n" is an odd number, an even number that is one larger than this odd number is used for the calculation. However, the minimum even number is 4. So, 4 is used for the calculation when "n" is 1 to 3.

Operating Range/CDG1, MGG, MGC

Auto switch model	Bore size (mm)							
	20	25	32	40	50	63	80	100
D-M9□/M9□V D-M9□W/M9□VV D-M9□A/M9□AV	4	4	5	4	5.5	6.5	7.5	7
D-F7□/F79F/F7□V D-J79/J79C D-F7□W/J79W/F7□VV D-F7BA/F7BAV D-F7NT	4.5	4	4.5	5	5	6	6	6
D-A7□/A80 D-A7□H/A80H D-A73C/A80C	9	9	10	11	11	13.5	13	13.5
D-A79W	11	11	13	14	14	16.5	16	16.5

* Since the operating range is provided as a guideline including hysteresis, it cannot be guaranteed. (Assuming approximately ±30% dispersion.) It may vary substantially depending on an ambient environment.

Auto Switch Mounting Bracket: Part No./CDG1, MGG, MGC

Auto switch model	Bore size (mm)	
	ø20 to ø100	
D-M9□/M9□V D-M9□W/M9□VV	BQ2-012	
D-A9□A/A9□AV	BQ2-012S	

Note 1) When adding D-M9□(V) and D-A9□W(V), order a set of auto switch mounting brackets BQ-1 and BQ2-012 for the CDQ2 series (ø12 to ø25) separately.
When ordering the auto switches other than D-M9□□□ mentioned on the left and D-F7BA(V), order auto switch mounting brackets BQ-1 separately.

Note 2) When adding D-M9□A(V), order a stainless steel screw set BBA2 together with BQ2-012S separately.
When adding the auto switch D-F7BA(V), order a stainless steel screw set BBA2 separately.

Made to Order Common Specifications: -XC17: Pin Cylinder with Rod Quenched



26 Pin Cylinder with Rod Quenched

Symbol
-XC17

The piston rod material is changed and the rod end is quenched.

Applicable Series

Series	Description	Model	Action	Note	Vol. no. (for std model)
CJP	Pin cylinder	CJPB-Z	Single acting (Panel mount)	Except $\phi 4$	Web Catalog
		CJPS-Z	Single acting (Embedded)	Except $\phi 4$	
		CJPB	Single acting (Panel mount)	Except $\phi 4$	
		CJPS	Single acting (Embedded)	Except $\phi 4$	

How to Order

CJP -XC17

Note) Additional symbol for "-B" (without thread) is unnecessary when indicating the model no.

Rod quenched specifications

Specifications: Same as standard type

Construction (Dimensions are the same as standard.)

Panel mount type: CJPB

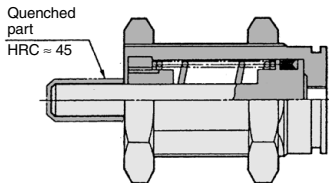

Embedded type: CJPS

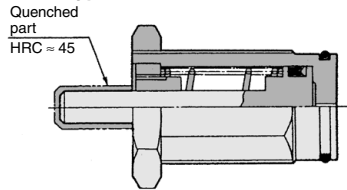

Made to Order Common Specifications: -XC19: Intermediate Stroke (Spacer Type)



27 Intermediate Stroke (Spacer type)

Symbol
-XC19

Dealing with the intermediate stroke by installing a spacer with the standard stroke cylinder.

Applicable Series

Series	Description	Model	Action	Note	Vol. no. (for std model)
CU	Free mount cylinder	CU	Double acting, Single rod	5 mm spacer only	Web Catalog
	Non-rotating rod type	CUK	Double acting, Single rod	5 mm spacer only	
	Long stroke	CU	Double acting, Single rod	5 mm spacer only	
	Long stroke, Non-rotating	CUK	Double acting, Single rod	5 mm spacer only	
CJP2	Pin cylinder	CJP2	Double acting, Single rod	Except ø4	
MGP	Compact guide cylinder	MGP ^{KA} _{AZ}	Double acting	Air cushion type only	
MXH	Compact slide	MXH-Z	Double acting	5 mm spacer only	
CXS	Dual rod cylinder	CXS ^{LA}	Double acting	5 mm spacer only	
CXSJ	Dual rod cylinder compact type	CXSJ ^{LA}	Double acting	5 mm spacer only	

How to Order

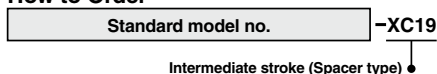

CU

Applicable Stroke

Stroke (mm)	Stroke (mm)
ø6, ø10, ø16	35, 45, 55
ø20, ø25, ø32	35, 45, 55, 65, 75, 85, 95

- Dealing with it by installing a 5 mm width spacer with the standard stroke cylinder.
- Specifications other than above are the same as standard type.
- External dimensions are the same as standard stroke products added by 5 mm for the required stroke.
- Please consult with SMC when stroke other than applicable stroke is required.

CJP2

Applicable Stroke

Stroke (mm)	Stroke (mm)
ø6	1 mm increments in 24 st or less
ø10, ø16	1 mm increments in 39 st or less

- Dealing with it by installing a 1 to 4 mm width spacer with the standard stroke cylinder.
- Specifications other than above are the same as standard type.
- External dimensions are the same as standard stroke products which is closed to the required intermediate stroke.
Example: For 11 ST, to b-e dealt with 4 mm spacer for 15 st body
- As for the one with switch, 5 st or less will not be available.

MGP(Air Cushion Type)

Applicable Stroke

Description	Dealing with the stroke in 1 mm increments by changing a collar of the standard stroke cylinder. Minimum manufacturable stroke ø16 to ø63: 15 mm ø80, ø100: 20 mm Select a rubber bumper type, because the cushion effect is not obtainable for less than this stroke.	
Part no.	Suffix "-XC19" to the end of standard part number.	
Applicable stroke (mm)	ø16	15 to 249
	ø20 to ø63	15 to 399
	ø80, ø100	20 to 399
Example	Part no. MGPM20-35AZ-XC19 15 mm width collar is installed in MGPM20-50AZ. C dimension is 112 mm.	

(Note) Intermediate strokes (in 1 mm increments) with a special body are available by made-to-order.

CXS

Applicable Stroke

Stroke (mm)	Stroke (mm)
ø6	15, 25, 35, 45
ø10	55, 65
ø15	55, 65, 85, 95
ø20	
ø25	
ø32	

- Dealing with it by installing a 5 mm width spacer with the standard stroke cylinder.
- Specifications other than above are the same as standard type.
- External dimensions are the same as standard stroke products added by 5 mm for the required stroke.
- Please consult with SMC when stroke other than applicable stroke is required.

MXH

Applicable Stroke

Stroke (mm)	Stroke (mm)
ø6, ø10, ø16, ø20	35, 45, 55

- Dealing with it by installing a 5 mm width spacer with the standard stroke cylinder.
- Specifications other than above are the same as standard type.
- External dimensions are the same as standard stroke products added by 5 mm for the required stroke.
- Please consult with SMC when stroke other than applicable stroke is required.

CXSJ

Applicable Stroke

Stroke (mm)	Stroke (mm)
ø6	15, 25, 35, 45
ø10	15, 25, 35, 45, 70
ø15	15, 25, 35, 45, 70, 95
ø20	
ø25	
ø32	

- Dealing with it by installing a 5 mm width spacer with the standard stroke cylinder.
- Specifications other than above are the same as standard type.
- External dimensions are the same as standard stroke products added by 5 mm for the required stroke.
- Please consult with SMC when stroke other than applicable stroke is required.

Made to Order Common Specifications: -XC20: Head Cover Axial Port



28 Head Cover Axial Port

Symbol
-XC20

Head side port position is changed to the axial direction. (Standard head side port is plugged with hexagon socket head screw.)

Applicable Series

Series	Description	Model	Action	Note	Vol. no. (for std model)
CM2	Air cylinder	CM2-Z	Double acting, Single rod	Except with air cushion	
			Single acting (Spring return/extend)		
	Non-rotating rod type	CM2K-Z	Double acting, Single rod	Except with air cushion	
			Single acting (Spring return/extend)		
			Direct mount type		
Non-rotating rod, Direct mount type	CM2RK-Z	Double acting, Single rod	Except with air cushion		
Smooth cylinder	CM2Y-Z	Double acting, Single rod			
CG1	Air cylinder	CG1-Z1	Double acting, Single rod	Except double clevis type (D)	Web Catalog
			Single acting (Spring return/extend)	Except with air cushion	
	Non-rotating rod type	CG1K-Z	Double acting, Single rod	Except with air cushion	
			Direct mount type	CG1R-Z	
	Non-rotating rod, Direct mount type	CG1KR-Z	Double acting, Single rod	Except with air cushion	
	Smooth cylinder	CG1Y-Z	Double acting, Single rod		

How to Order

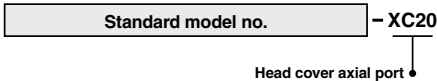

Specifications: Same as standard type

* Be sure to use the speed controller since head side port has no throttle.

Construction (*Same dimensions as standard type except port size.)

CM2 series

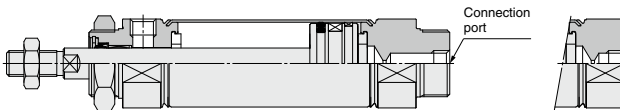

Bore size (mm)	Port size
20, 25, 32	Rc 1/8
40	Rc 1/4

CG1 series CG1-Z1 series

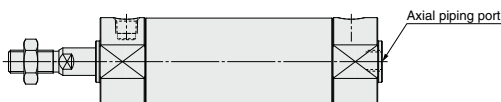

Bore size (mm)	Port size
20, 25, 32, 40	Rc 1/8
50, 63	Rc 1/4
80*	Rc 3/8
100*	Rc 1/2

* CG1-Z1 only

Made to Order Common Specifications: -XC22: Fluororubber Seals



29 Fluororubber Seals

Symbol
-XC22

Applicable Series

Series	Description	Model	Action	Note	Vol. no. (for std model)
CJP	Pin cylinder	CJPB-Z	Single acting (Panel mounting)	Except ø4	
		CJPS-Z	Single acting (Embedded)	Except ø4	
		CJP2	Double acting, Single rod	Except ø4, Packing set (6)	
		CJPB	Single acting (Panel mounting)	Except ø4	
		CJPS	Single acting (Embedded)	Except ø4	
CJ2	Air cylinder	CJ2-Z	Double acting, Single rod Single acting (Spring return/extend)	Except with air cushion	Web Catalog
		CJ2W-Z	Double acting, Double rod	Except with air cushion	
	Non-rotating rod type	CJ2K-Z	Double acting, Single rod		
	Direct mount type	CJ2R-Z	Double acting, Single rod		
CM2	Air cylinder	CM2-Z	Double acting, Single rod		
		CM2W-Z	Double acting, Double rod		
	Non-rotating rod type	CM2K-Z	Double acting, Single rod		
		CM2KW-Z	Double acting, Double rod		
	Direct mount type	CM2R-Z	Double acting, Single rod		
	Non-rotating rod, Direct mount type	CM2RK-Z	Double acting, Single rod		
End lock cylinder	CBM2	Double acting, Single rod			
CG1	Air cylinder	CG1-Z	Double acting, Single rod	Without a bumper for cylinders with a rubber bumper	(4)
	Double rod type	CG1W-Z	Double acting, Double rod	Without a bumper for cylinders with a rubber bumper	
	Direct mount type	CG1R-Z	Double acting, Single rod	Without a bumper for cylinders with a rubber bumper	
MB	Air cylinder	MB-Z	Double acting, Single rod	Except ø125, Air cushion only	
		MBW-Z	Double acting, Double rod	Except ø125, Air cushion only	
MB1	Air cylinder	MB1-Z	Double acting, Single rod	Except ø125, Air cushion only	
		MB1W-Z	Double acting, Double rod	Except ø125, Air cushion only	
CA2	Air cylinder	CA2-Z	Double acting, Single rod	Air cushion only	
		CA2W-Z	Double acting, Double rod	Air cushion only	
	End lock cylinder	CBA2	Double acting, Single rod		
CS1	Air cylinder	CS1	Double acting, Single rod	Applicable bore: Lube type 125 to 300, Non-lube type 125 to 200	
CS2	Air cylinder	CS2	Double acting, Single rod	Applicable to ø125 to ø160	Web Catalog
		CS2W	Double acting, Double rod	Applicable to ø125 to ø160	
CUJ	Mini free mount cylinder	CUJ	Double acting, Single rod	Except ø4, ø12 to ø20: A bumper is a standard product.	
CU	Free mount cylinder	CU	Double acting, Single rod Single acting (Spring return/extend)		
		CUK	Double acting, Single rod		
	Non-rotating rod type	CUK	Single acting (Spring return/extend)		
	Long stroke	CU	Double acting, Single rod		
	Long stroke, Non-rotating	CUK	Double acting, Single rod		
MGP	Compact guide cylinder	MGPM-Z	Double acting	Slide bearing only	
	Heavy duty guide rod type	MGPS	Double acting		
MGQ	Compact guide cylinder	MGQM	Double acting	Slide bearing only	(5)
MGG	Guide cylinder	MGG	Double acting	Without rubber bumper	
MGC	Guide cylinder	MGC	Double acting		
CEP1	High precision stroke reading cylinder	CEP1	Double acting, Single rod		
MXH	Compact slide	MXH-Z	Double acting		
CXS	Dual rod cylinder	CXS	Double acting		Web Catalog
CXSJ	Dual rod cylinder compact type	CXSJ	Double acting		
CX2	Slide unit	CX2	Double acting		
CXW	Slide unit	CXW	Double acting		
MK	Rotary clamp cylinder	MK	Double acting	The bumper is a standard product.	

How to Order

Standard model no. **-XC22**

Fluororubber seals

Specifications

Seal material	Fluororubber	
Ambient temperature range	With auto switch : -10 to 60°C (0°C to 60°C for CS1, CS2 series) Without auto switch : -10 to 70°C (0°C to 70°C for CS1, CS2 series)	Note 1) (No freezing)
Specifications other than above and external dimensions	Same as standard type for each series	

Note 1) Please confirm with SMC, as the type of chemical and the operating temperature may not allow the use of this product.

Note 2) Cylinders with auto switches can also be produced; however, auto switch related parts (auto switch units, mounting brackets, built-in magnets) are the same as standard products. Before using these, please contact SMC regarding their suitability for the operating environment.

Note 3) The MGQ series is using a shock absorber RBL type.

Note 4) No cushion is equipped for N type. Piston speed is ranged from 50 to 500 mm/s.

Note 5) The MGP and MGQ series are without a cushion.

Confirm the kinetic energy.

Note 6) Refer to the construction of the standard type for the details of the packing set for CJP2□6,10 and 16.

Made to Order Common Specifications: -XC22: Fluororubber Seals



29 Fluororubber Seals

Symbol
-XC22

How to Order

MGPM **-XC22**
Fluororubber seals

Dimensions

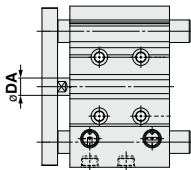

(mm)			
Bore size (mm)	DA	Bore size (mm)	DA
12	(6)	40	(14)
16	(8)	50	20
20	(10)	63	20
25	(10)	80	25
32	(14)	100	30

The dimensions in () are the same as standard type.

How to Order

MGC **-XC22**
Fluororubber seals

Dimensions (Dimensions other than below are the same as standard type.)

MGCLB series

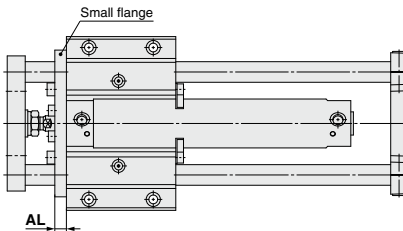

(mm)	
Bore size (mm)	AL
20	9
25	9
32	9
40	12
50	12

Made to Order Common Specifications: -XC24: With Magnetic Shielding Plate -XC25: No Fixed Throttle of Connection Port



30 With Magnetic Shielding Plate -XC24

Symbol

Shields against the magnetic leaked from external slider.

Applicable Series

Series	Description	Model	Action	Vol. no. (for std model)
CY3	Magnetically coupled rodless cylinder	CY3B-Z	Double acting	Web Catalog
		CY3B		
REA	Sine rodless cylinder	REA	Double acting	

How to Order

CY3B
REA -XC24
 With magnetic shielding plate

Specifications: Same as standard type

Dimensions

Magnetic shielding plate (t=1 mm)

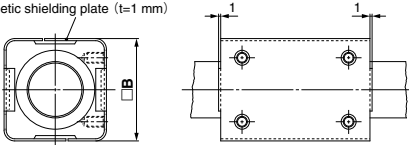

Dimensions	Bore size (mm)								
	ø6	ø10	ø15	ø20	ø25	ø32	ø40	ø50	ø63
□B	19	27	37	38	48	62	72	88	102
Standard external (□B)	17	25	35	36	46	60	70	86	100

* Dimensions except mentioned above are the same as standard type.
* REA is ø25 to ø63.

31 No Fixed Throttle of Connection Port -XC25

Symbol

A CM2 series air cylinder with no restrictor on the rod cover and head cover ports

Applicable Series

Series	Description	Model	Action	Vol. no. (for std model)
CM2	Air cylinder	CM2-Z	Double acting, Single rod	Web Catalog
			Single acting (Spring return/air)	
		CM2W-Z	Double acting, Double rod	
	Non-rotating rod type	CM2K-Z	Double acting, Single rod	
		CM2KW-Z	Double acting, Double rod	
	Direct mount type	CM2R-Z	Double acting, Single rod	
	Non-rotating rod, Direct mount type	CM2RK-Z	Double acting, Single rod	
	Smooth cylinder	CM2Y-Z	Double acting, Single rod	

* Except with air cushion (Standard equipment)

How to Order

CM2 -XC25
 No fixed throttle in connection port

Specifications/ Dimensions: Same as standard type

⚠ Caution

1. Use a shock absorber, etc.

When the piston speed exceed 750 mm/s, make sure that direct impact does not apply on the cylinder cover by using an external stopper (shock absorber, etc).

Made to Order Common Specifications: -XC26: With Split Pins for Double Clevis Pin and Double Knuckle Joint Pin and Flat Washers



32 With Split Pins for Double Clevis Pin/Double Knuckle Joint Pin and Flat Washers **-XC26**

Flat washer is added for the double clevis (one of the mounting types) or double knuckle joint (one of the accessories).

Applicable Series

Series	Description	Model	Action	Note	Vol. no. (for std model)
MB	Air cylinder	MB	Double acting, Single rod	ø125 only	Web Catalog
			Double acting, Single rod	ø125 only	
MB1	Air cylinder	MB1W	Double acting, Double rod	ø125 only	
			Double acting, Double rod	ø125 only	
CS1	Standard type	CS1	Double acting, Single rod	ø125 to ø160 only	
	Low friction	CS1Q	Double acting, Single rod		
CS2	Standard type	CS2	Double acting, Single rod	ø125 to ø160 only	
	Smooth cylinder	CS2Y	Double acting, Single rod		

Specifications

Mounting type	Only double clevis type (D), Double knuckle joint
Changed parts	Clevis pin, knuckle joint pin, flat washer
Specifications other than above	Same as standard type

Dimensions (Dimensions other than below are the same as standard type.)

Double clevis

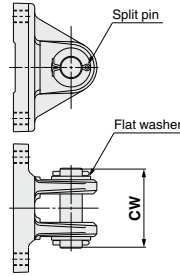

- * For mounting bracket, split pin, clevis pin and flat washer are shipped together, (but not assembled).
- * Mounting method is the same as standard type.

Bore size (mm)	CW
ø125	90
ø140	104
ø160	113
ø180	136
ø200	136
ø250	169
ø300, ø320	207

How to Order

• Product

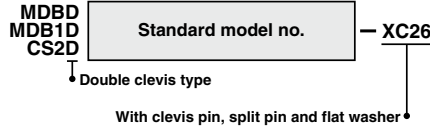

• Parts assembly

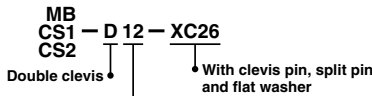

Bore size	Applicable model
12	125 mm MB, MB1, CS1, CS2
14	140 mm CS1, CS2
16	160 mm CS1, CS2
18	180 mm CS1, CS2
20	200 mm CS1, CS2
25	250 mm CS1, CS2
30	300 mm CS1
32	320 mm CS2

Double knuckle joint

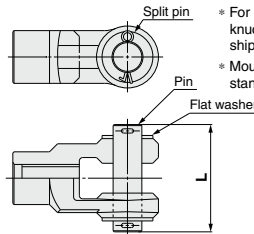

- * For mounting bracket, split pin, knuckle joint pin and flat washer are shipped together, (but not assembled).
- * Mounting method is the same as standard type.

Bore size (mm)	L
ø125	90
ø140	104
ø160	113
ø180	136
ø200	136
ø250	169
ø300, ø320	207

CS1 Y — 12, 14, 16, 18, 20, 25, 30 — **XC26**

MB
MB1 Y — 12A, 14A, 16A, 18A, 20A, 25A, 32A — **XC26**
CS2

Double knuckle joint

With knuckle joint pin, split pin and flat washer

IY — 12, 14, 16, 18, 25, 30 — **XC26**

Clevis pin/Knuckle joint pin

With clevis pin, knuckle joint pin, split pin, and flat washer

Made to Order Common Specifications: -XC26: With Split Pins for Double Clevis Pin and Double Knuckle Joint Pin and Flat Washers



32 With Split Pins for Double Clevis Pin/Double Knuckle Joint Pin and Flat Washers -XC26

A pin for double clevis (one of the mounting types) or double knuckle joint (one of the accessories) has been changed for a split pin, and split pins and flat washers have been added.

Applicable Series

Series	Model	Action	Note	Vol. no. (for std model)
CQS	Standard	CQS	Double acting, Single rod Single acting (Spring return/stand)	Web Catalog
	Long stroke	CQS	Double acting, Single rod	
	Non-rotating rod	CQSK	Double acting, Single rod	
	Anti-lateral load	CQS□S	Double acting, Single rod	
CQ2	Compact cylinder	CQ2	Double acting, Single rod Single acting (Spring return/stand)	
	Long stroke	CQ2	Double acting, Single rod	
	Non-rotating rod	CQ2K	Double acting, Single rod	
	Anti-lateral load	CQ2□S	Double acting, Single rod	
	With end lock	CBQ2	Double acting, Single rod	

Specifications

Mounting	Double clevis (D) only
Changed parts	Clevis pin/Knuckle pin, Split pin, Flat washer
Specifications other than above	Same as standard

How to Order

● Product

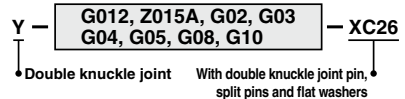
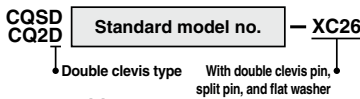

● Parts assembly

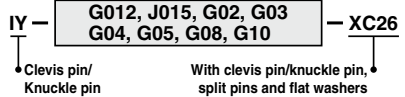
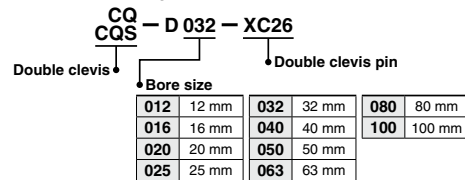

* For the CQS, only bore sizes 012 to 025 are selectable.

Dimensions (Dimensions other than those below are the same as those of the standard type.)

Double clevis

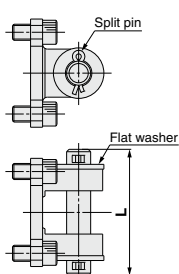

Double knuckle joint

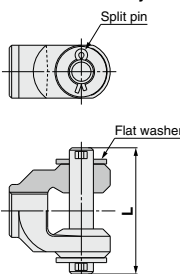

Clevis pin/Knuckle joint pin

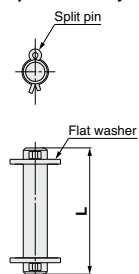

* Body mounting bolts, pin, split pins, and flat washers are included.

* A pin, split pins, and flat washers are included.

* Split pins and flat washers are included.

Bore size (mm)	Double clevis	Double knuckle joint	Clevis pin Knuckle joint pin	L (mm)
12	CQ-D012-XC26	Y-G012-XC26	IY-G012-XC26	21
16	CQ-D016-XC26	Y-Z015A-XC26	IY-J015-XC26	23
20	CQ-D020-XC26	Y-G02-XC26	IY-G02-XC26	31
25	CQ-D025-XC26	Y-G03-XC26	IY-G03-XC26	36.5
32	CQ-D032-XC26			
40	CQ-D040-XC26	Y-G04-XC26	IY-G04-XC26	52.5

Bore size (mm)	Double clevis	Double knuckle joint	Clevis pin Knuckle joint pin	L (mm)
50	CQ-D050-XC26			
63	CQ-D063-XC26	Y-G05-XC26	IY-G05-XC26	66
80	CQ-D080-XC26	Y-G08-XC26	IY-G08-XC26	78
100	CQ-D100-XC26	Y-G10-XC26	IY-G10-XC26	86

Made to Order Common Specifications:

-XC26: Double Clevis Width 12.5 mm, 16.5 mm, 19.5 mm: With Double Clevis and Double Knuckle Joint



33 Double Clevis Width, Double Knuckle Joint Width 12.5 mm, 16.5 mm, or 19.5 mm: With Double Clevis and Double Knuckle Joint -XC26

3 different double clevis widths and double knuckle joint widths are selectable: 12.5 mm, 16.5 mm, or 19.5 mm

Series	Description	Model	Action	Note	Vol. no. (for std model)
CQ2	Compact cylinder	CQ2	Double acting, Single rod	Applicable to ø32 to ø63 Double clevis (D) mounting only	Web Catalog
	Long stroke	CQ2			
	Anti-lateral load	CQ2□S			

Specifications:
Same as those of the standard type

How to Order

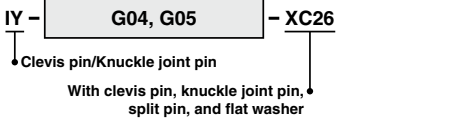
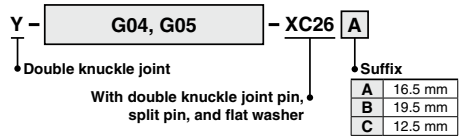
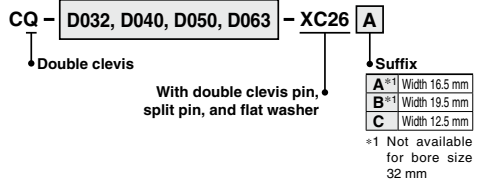
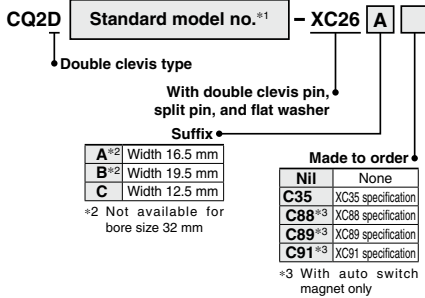

*1 Can be ordered with a rod end bracket (double knuckle joint)

Applicable Made to Order Options

Series	Made to order			
	XC35	XC88	XC89	XC91
Compact cylinder	●	●	●	—
Long stroke	●	●	●	●
Anti-lateral load	—	—	●	●

* For details on XC35 ⇨ Web Catalog

For details on XC88, 89, and 91 ⇨ Web Catalog

Dimensions (Dimensions other than those below are the same as those of the standard type.)

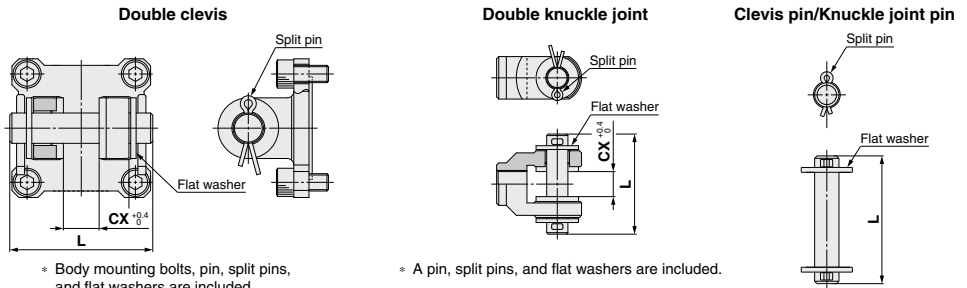

Bore size [mm]	Double clevis	Double knuckle joint	Clevis pin Knuckle joint pin	[mm]	
				CX	L
32	CQ-D032-XC26C	Y-G04-XC26C	IY-G04-XC26	12.5	52.5
	CQ-D040-XC26A	Y-G04-XC26A		16.5	
40	CQ-D040-XC26B	Y-G04-XC26B	IY-G05-XC26	19.5	66
	CQ-D040-XC26C	Y-G04-XC26C		12.5	
50	CQ-D050-XC26A	Y-G05-XC26A	IY-G05-XC26	16.5	66
	CQ-D050-XC26B	Y-G05-XC26B		19.5	
63	CQ-D050-XC26C	Y-G05-XC26C	IY-G05-XC26	12.5	66
	CQ-D063-XC26A	Y-G05-XC26A		16.5	
63	CQ-D063-XC26B	Y-G05-XC26B	IY-G05-XC26	19.5	66
	CQ-D063-XC26C	Y-G05-XC26C		12.5	

Made to Order Common Specifications: -XC27: Double Clevis and Double Knuckle Joint Pins Made of Stainless Steel



34 Double Clevis and Double Knuckle Joint Pins Made of Stainless Steel

Symbol
-XC27

To prevent the oscillating portion of the double clevis or the double knuckle joint from rusting, the material of the pin and the retaining ring has been changed to stainless steel.

Applicable Series

Series	Description	Model	Action	Vol. no. (for std model)
CM2	Standard type	CM2-Z	Double acting, Single rod ⁽¹⁾ Single acting (Spring return) ⁽¹⁾	Web Catalog
	Non-rotating rod type	CM2K-Z	Double acting, Single rod ⁽¹⁾ Single acting (Spring return) ⁽¹⁾	
	End lock cylinder	CBM2	Double acting, Single rod	
	Smooth cylinder	CM2Y-Z	Double acting, Single rod	
CG1	Air cylinder	CG1-Z1	Double acting, Single rod	
	Standard type	CG1-Z	Double acting, Single rod ⁽¹⁾ Single acting (Spring return) ⁽¹⁾	
MB	Non-rotating rod type	CG1K-Z ⁽²⁾	Double acting, Double rod ⁽¹⁾	
	Standard type	MB-Z	Double acting, Double rod ⁽¹⁾	
	Non-rotating rod type	MBK-Z	Double acting, Single rod ⁽¹⁾	
		MBKW-Z	Double acting, Double rod	
MB1	With end lock	MBB	Double acting, Single rod	
	Smooth cylinder	MBY-Z	Double acting, Single rod ⁽¹⁾	
	Standard type	MB1-Z	Double acting, Single rod ⁽¹⁾	
CA2	Non-rotating rod type	MB1K-Z	Double acting, Single rod ⁽¹⁾	
	Standard type	CA2-Z	Double acting, Single rod ⁽¹⁾	
	Non-rotating rod type	CA2K	Double acting, Single rod	
	End lock cylinder	CBA2	Double acting, Single rod	
	Air-hydro cylinder	CA2H	Double acting, Single rod	
	Smooth cylinder	CA2Y-Z	Double acting, Single rod	

Series	Description	Model	Action	Vol. no. (for std model)
CS1	Standard type	CS1	Double acting, Single rod	Web Catalog
	Low friction	CS1Q	Double acting, Single rod	
CS2	Standard type	CS2	Double acting, Single rod	
	Smooth cylinder	CS2Y	Double acting, Single rod	
CQS	Standard type	CQS	Double acting, Single rod Single acting (Spring return) ⁽¹⁾	
	Long stroke	CQS	Double acting, Single rod	
	Anti-lateral load type	CQS□S	Double acting, Single rod	
	Non-rotating rod type	CQSK	Double acting, Single rod	
CQ2	Standard type	CQ2-Z	Double acting, Single rod ⁽¹⁾ Single acting (Spring return) ⁽¹⁾	
	Long stroke	CQ2-Z	Double acting, Single rod	
	Anti-lateral load type	CQ2□S-Z	Double acting, Single rod	
	Non-rotating rod type	CQ2K-Z	Double acting, Single rod	

Note 1) Except cylinders with double knuckle joint bracket in How to Order
Note 2) Except ø20, ø25, and ø32 with air cushion

How to Order

CM2D	Standard model no.	-XC27
CG1D	Standard model no.	-XC27
CA2D	Standard model no.	-XC27
CS1D	Standard model no.	-XC27
CS2D	Standard model no.	-XC27
CQSD	Standard model no.	-XC27
CQ2D	Standard model no.	-XC27
	Double clevis type	Double clevis pin made of stainless steel
Y -	G012, Z015A, G02, G03, G04, G05, G08, G10	-XC27
Y -	020B, 032B, 040B	-XC27
Y -	04D, 05D, 08D, 10D	-XC27
Y -	12, 14, 16, 18, 20, 25, 30	-XC27
Y -	12A, 14A, 16A, 18A, 20A, 25A, 32A	-XC27
	Double knuckle joint	Double knuckle joint pin made of stainless steel

Specifications

Mounting type	Only double clevis type (D), Double knuckle joint only
Pin and retaining ring material	Stainless steel 304
Specifications other than above	Same as standard type

IY -	12, 14, 16, 18, 20, 25, 30	-XC27
IY -	G012 (J015)*, G02, G03, G04, G05, G08, G10	-XC27
CD -	M03, M05, M08	-XC27
CD -	G02, G25, G03, G04, G05, G06	-XC27
CDP -	1, 2, 3	-XC27
CDP -	2A, 3A, 4A, 5A, 6A, 7A	-XC27
	Clevis pin Knuckle pin	made of stainless steel

* Stainless steel specification for IY-J015 is IY-J015SUS.

Mounting brackets, accessories, and nut material: Stainless steel

The following accessories need to be prepared separately. (Please order separately.) Refer to the 'Accessories' page of each series for details.

Series	Bore size (mm)	Foot	Flange	Single knuckle joint	Double knuckle joint	Mounting nut	Rod end nut	Accessories page
CM2	20, 25, 32, 40	○	○	○	○	○	○	Web Catalog
CG1	20, 25, 32, 40, 50, 63, 80, 100	○*	○*	○	○	—	○	
CQ2	20, 25, 32, 40, 50, 63, 80, 100	—	—	○	○	—	○	

* Except bore size 20 and 25.

Made to Order Common Specifications: -XC28: Compact Flange Made of SS400



35 Compact Flange Made of SS400

Symbol
-XC28

Width of a flange bracket on the rod and head side has the same dimensions as the cylinder's rod cover to save the mounting space. (Flange shape and FV-dimensions are only different from the standard type.)

Applicable Series

Series	Description	Model	Action	Vol. no. (for std model)
CA2	Air cylinder	CA2-Z	Double acting, Single rod	Web Catalog
		CA2W-Z	Double acting, Double rod	
	Non-rotating rod type	CA2K	Double acting, Single rod	
		CA2KW	Double acting, Double rod	
	With end lock	CBA2	Double acting, Single rod	
	Air-hydro cylinder	CA2H	Double acting, Single rod	
CA2HW		Double acting, Double rod		
Smooth cylinder	CA2Y-Z	Double acting, Single rod		

How to Order

CA2 **F** Standard model no. -XC28

Compact flange made of SS400

• Mounting type

F	Rod side flange
G	Head side flange

Specifications: Same as standard type

Dimensions

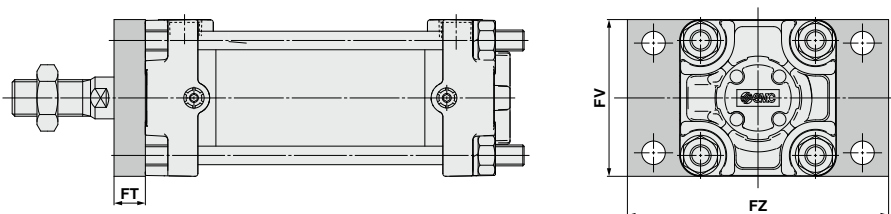

Bore size (mm)	(mm)		
	FT	FV	FZ
40	12	60	100
50	12	70	110
63	15	85	130
80	18	102	160
100	18	116	180

* Other dimensions are the same as flange on the rod side and head side of standard type.
(Figure is the case of flange on the rod side.)

Made to Order Common Specifications: -XC29: Double Knuckle Joint with Spring Pin



36 Double Knuckle Joint with Spring Pin

Symbol
-XC29

To prevent loosening of the double knuckle joint

Applicable Series

Series	Description	Model	Action	Vol. no. (for std model)
CM2	Air cylinder	CM2-Z	Double acting, Single rod ⁽¹⁾ Single acting (Spring return) ⁽¹⁾	Web Catalog
		CM2W-Z	Double acting, Double rod	
	CM2R-Z	Double acting, Single rod ⁽¹⁾		
	Centralized piping type	CM2□□P	Double acting, Single rod	
	End lock cylinder	CBM2	Double acting, Single rod	
Smooth cylinder	CM2Y-Z	Double acting, Single rod		
CG1	Air cylinder	CG1-Z1	Double acting, Single rod	Web Catalog
		CG1-Z	Double acting, Single rod ⁽¹⁾ Single acting (Spring return) ⁽¹⁾ ⁽²⁾	

Series	Description	Model	Action	Vol. no. (for std model)
MB	Air cylinder	MB-Z [*]	Double acting, Single rod ⁽¹⁾	Web Catalog
	Cylinder with end lock	MBB	Double acting, Single rod	
	Smooth cylinder	MBY-Z	Double acting, Single rod	
MB1	Air cylinder	MB1-Z [*]	Double acting, Single rod ⁽¹⁾	Web Catalog
CA2	Air cylinder	CA2-Z	Double acting, Single rod ⁽¹⁾	
	End lock cylinder	CBA2	Double acting, Single rod	
	Air-hydro cylinder	CA2H	Double acting, Single rod	
	Smooth cylinder	CA2Y-Z	Double acting, Single rod	Web Catalog
CV	Valve mounted air cylinder	CV3	Double acting, Single rod	

* Except $\phi 125$

Note 1) Except cylinders with rod end bracket in How to Order
Note 2) Compatible with rubber bumper only

How to Order

Standard model no. **-XC29**
Double knuckle joint with spring pin

Specifications: Same as standard type

Dimensions (For mounting bracket, pin is shipped together.)

CM2 series

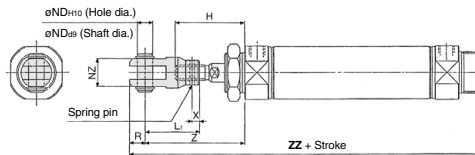

Bore size (mm)	H	L ₁	NDH ₁₀	NZ	R	X	Z	ZZ	Spring pin
20	41	36	9 ^{+0.058} ₀	18	10	5	61	146	ø3 x 16L
25	45	38	9 ^{+0.058} ₀	18	10	5	65	150	ø3 x 16L
32	45	38	9 ^{+0.058} ₀	18	10	5	65	152	ø3 x 16L
40	50	55	12 ^{+0.070} ₀	38	13	11	83	200	ø4 x 24L

* Other dimensions are the same as standard type.

CA2 series

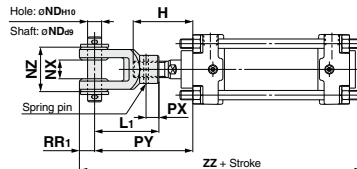

Bore size (mm)	H	L ₁	PX	PY	ZZ	RR ₁	øND	H10	d _e	NX	NZ	Spring pin
40	51	55	11	84	192	13	12	+0.070 0	-0.050 -0.093	16 ^{+0.3} -0.1	38	ø4 x 24L
50	58	60	12	91	207	15	12	+0.070 0	-0.050 -0.093	16 ^{+0.3} -0.1	38	ø4 x 25L
63	58	60	12	91	218	15	12	+0.070 0	-0.050 -0.093	16 ^{+0.3} -0.1	38	ø4 x 25L
80	71	71	16	105	257	19	18	+0.070 0	-0.050 -0.093	28 ^{+0.3} -0.1	55	ø4 x 36L
100	72	83	16	118	282	21	20	+0.084 0	-0.065 -0.117	30 ^{+0.3} -0.1	61	ø4 x 40L

* Dimensions except mentioned above are the same as standard type.

Made to Order Common Specifications: -XC30: Rod Side Trunnion



37 Rod Side Trunnion

Symbol
-XC30

This cylinder shortens the distance between the fulcrum and the rod end by installing a trunnion bracket in front of the rod side cover.

Applicable Series

Series	Description	Model	Action	Note	Vol. no. (for std model)
MB	Standard type	MB-Z ^{*1}	Double acting, Single rod		Web Catalog
		MBW-Z ^{*1}	Double acting, Double rod		
	Non-rotating rod type	MBK-Z	Double acting, Single rod		
	Cylinder with end lock	MBB	Double acting, Single rod		
	Smooth cylinder	MBY-Z	Double acting, Single rod		
MB1	Standard type	MB1-Z ^{*1}	Double acting, Single rod		
		MB1W-Z ^{*1}	Double acting, Double rod		
	Non-rotating rod type	MB1K-Z	Double acting, Single rod		
CA2	Air cylinder	CA2-Z	Double acting, Single rod		
	End lock cylinder	CBA2 ^{*2}	Double acting, Single rod		
	Smooth cylinder	CA2Y-Z	Double acting, Single rod		
CS1	Standard type	CS1	Double acting, Single rod		
		CS1W	Double acting, Double rod		
CS2	Standard type	CS2	Double acting, Single rod	ø125 to ø160 only	
		CS2W	Double acting, Double rod	ø125 to ø160 only	
CS2	Smooth cylinder	CS2Y	Double acting, Single rod	ø125 to ø160 only	

How to Order

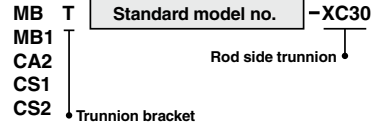

Specifications: Same as standard type

*1 Except ø125

*2 Only applicable to the type with a head side end lock

Dimensions (Dimensions other than below are the same as standard type.)

CA2 series

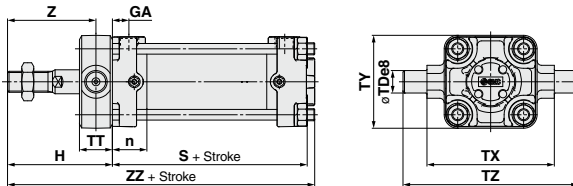

(mm)

Symbol	n	GA	H	S	TDe8	TT	TX	TY	TZ	Z	ZZ
Bore size											
40	23	11	66	80	15 ^{-0.032} _{-0.059}	22	85	62	117	55	151
50	26	13	71	86	15 ^{-0.032} _{-0.059}	22	95	74	127	60	163
63	27	13	79	94	18 ^{-0.032} _{-0.059}	28	110	90	148	65	179
80	32	16	94.5	111	25 ^{-0.043} _{-0.073}	34	140	110	192	77.5	212.5
100	35	16	100	121	25 ^{-0.040} _{-0.073}	40	162	130	214	80	229

MB series

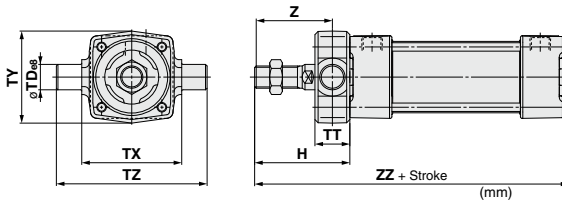

(mm)

Bore size	H	øTDe8	TT	TX	TY	TZ	Z	ZZ
32	47	12 ^{-0.032} _{-0.059}	17	50	49	74	38.5	135
40	60	16 ^{-0.032} _{-0.059}	22	63	58	95	49	148
50	66	16 ^{-0.032} _{-0.059}	22	75	71	107	55	164
63	72	20 ^{-0.040} _{-0.073}	28	90	87	130	58	170
80	86	20 ^{-0.040} _{-0.073}	34	110	110	150	69	204
100	92	25 ^{-0.040} _{-0.073}	40	132	136	182	72	210

* Dimensions except mentioned above are the same as standard type.



Made to Order Common Specifications: -XC30: Rod Side Trunnion



37 Rod Side Trunnion

Symbol
-XC30

Dimensions (Dimensions other than below are the same as standard type.)

MB1 series

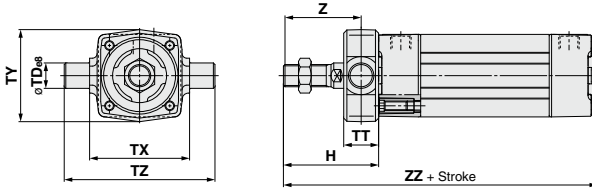

Bore size	H	øTDø8	TT	TX	TY	TZ	Z	ZZ
32	47	12 ^{+0.032} _{-0.059}	17	50	49	74	38.5	135
40	60	16 ^{+0.038} _{-0.059}	22	63	58	95	49	148
50	66	16 ^{+0.038} _{-0.059}	22	75	71	107	55	164
63	72	20 ^{+0.040} _{-0.073}	28	90	87	130	58	170
80	86	20 ^{+0.040} _{-0.073}	34	110	110	150	69	204
100	92	25 ^{+0.040} _{-0.073}	40	132	136	182	72	210

* Dimensions except mentioned above are the same as standard type.

CS1 series

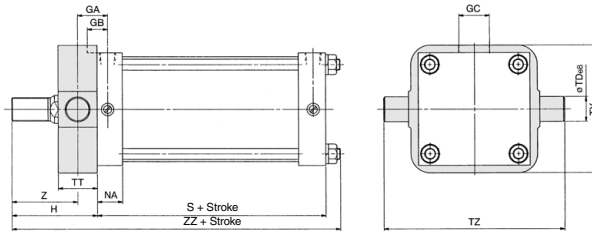

Bore size (mm)	Symbol	GA	GB	GC	NA	S	øTDø8	TT	TY	TZ	H	Z	ZZ
125		38	23	45	32	95	32 ^{-0.050} _{-0.089}	50	164	234	113	88.0	227
140		40.5	23	45	32	95	36 ^{-0.050} _{-0.089}	55	184	262	113	85.5	227
160		45.5	25.5	50	36	103	40 ^{-0.050} _{-0.089}	60	204	292	123	93.0	248
180		45	25.5	50	36	108	45 ^{-0.050} _{-0.089}	59	228	326	138	108.5	272
200		45	25.5	50	36	108	45 ^{-0.050} _{-0.089}	59	257	355	138	108.5	272
250		54.5	30	60	46	138	56 ^{-0.060} _{-0.106}	69	325	447	163	128.5	331
300		59.5	30	70	46	143	67 ^{-0.060} _{-0.106}	79	390	534	178	138.5	357

* Dimensions except mentioned above are the same as standard type.

CS2 series

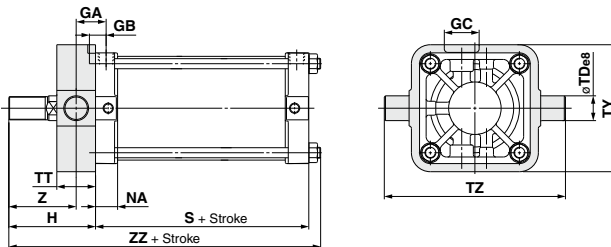

Bore size (mm)	GA	GB	GC	NA	S	TDø8	TT	TY	TZ	H	Z	ZZ
125	38	23	45	28.5	96	32 ^{-0.050} _{-0.089}	50	164	234	112	87	221
140	40.5	23	45	28.5	96	36 ^{-0.050} _{-0.089}	55	184	262	112	84.5	221
160	46	26	50	32.5	104	40 ^{-0.050} _{-0.089}	60	204	292	122	92	241

Made to Order Common Specifications: -XC34: Non-rotating Plate with Workpiece Mounting Screw (No extended part on the rod end)



38 Non-rotating Plate with Workpiece Mounting Screw (No extended part on the rod end) **-XC34**

The plate has workpiece mounting screws.
The dimension FL, the distance between a non-rotating plate to piston rod end, has been eliminated.
The piston rod does not protrude from the plate.

Applicable model no. **-XC34**

Applicable Series

Series	Description	Model	Action	Vol. no. (for std model)
CU	Non-rotating rod	CUK	Double acting, Single rod	Web Catalog
	Non-rotating rod	CUK	Single acting, Single rod (Spring return/extend)	
	Non-rotating rod/Long stroke	CUK	Double acting, Single rod	

Dimensions

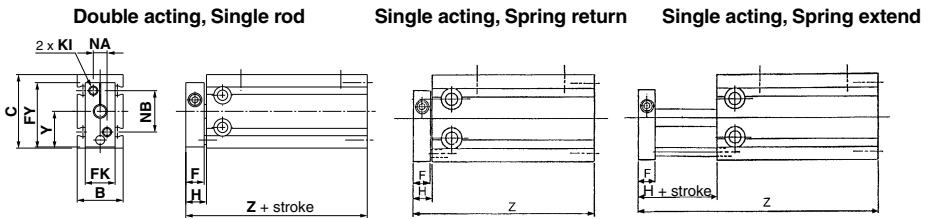

(mm)

Bore size (mm)	B	C	FK	FY	KI	NA	NB	Y
6	13	22	11	20.5	M3 x 0.5	6	14	10.5
10	15	24	12	22	M3 x 0.5	7	15	11.5
16	20	32	13	28	M4 x 0.7	6	18	15.5
20	26	40	16	33	M4 x 0.7	8	20	19.5
25	32	50	20	43.5	M5 x 0.8	10	28	24.5
32	40	62	24	51.5	M5 x 0.8	12	32	30.5

(mm)

Bore size (mm)	F	H	Action														
			Double acting		Single acting (Spring return)						Single acting (Spring extend)						
			Z		Z						Z						
			Without switch	With switch	Without switch			With switch			Without switch			With switch			
		5st	10st	15st	5st	10st	15st	5st	10st	15st	5st	10st	15st	5st	10st	15st	
6	8	9	42	42	47	52	57	47	52	57	52	62	67	52	62	67	
10	8	9	45	45	50	55	65	50	55	65	55	65	80	55	65	80	
16	8	9	39	49	44	49	59	54	59	69	59	69	84	69	79	94	
20	8	9	45	55	50	55	65	60	65	75	55	65	80	65	75	90	
25	10	11	51	61	56	61	71	66	71	81	61	71	86	71	81	96	
32	12	13	55	65	60	65	75	70	75	85	65	75	90	75	85	100	

* Dimensions except mentioned above are the same as standard type.

Made to Order Common Specifications: -XC35: With Coil Scraper



39 With Coil Scraper

Symbol
-XC35

It gets rid of frost, ice, weld spatter, cutting chips adhered to the piston rod, and protects the seals, etc.

Applicable Series

Series	Description	Model	Action	Note	Vol. no. (for std model)
CM2	Air cylinder	CM2-Z	Double acting, Single rod	Except with air cushion	
		CM2W-Z	Double acting, Double rod	Except with air cushion	
	Cylinder with end lock	CBM2	Double acting, Single rod	Lock in head end only (Except with air cushion)	
CG1	Air cylinder	CG1-Z1	Double acting, Single rod		
		CG1-Z	Double acting, Single rod		
MB	Air cylinder	MB-Z	Double acting, Single rod	Except ø125	
		MBW-Z	Double acting, Double rod	Except ø125	
MB1	Air cylinder	MB1-Z	Double acting, Single rod	Except ø125	
		MBW-Z	Double acting, Double rod	Except ø125	
CA2	Air cylinder	CA2-Z	Double acting, Single rod		
		CA2W-Z	Double acting, Double rod		
	Cylinder with end lock	CBA2	Double acting, Single rod		
CS1	Air cylinder	CS1	Double acting, Single rod		
		CS1W	Double acting, Double rod		
CS2	Air cylinder	CS2	Double acting, Single rod	Applicable to ø125 to ø250	
		CS2W	Double acting, Double rod	Applicable to ø125 to ø160	
CQ2	Compact cylinder	CQ2-Z	Double acting, Single rod	Applicable to ø32 to ø100	
		CQ2W-Z	Double acting, Double rod	Applicable to ø32 to ø100	
	Long stroke	CQP2	Double acting, Single rod	Applicable to ø32 to ø100, Except with bracket	
		CQ2-Z	Double acting, Single rod	Applicable to ø32 to ø100	
RQ	Compact cylinder with air cushion	RQ	Double acting, Single rod	Applicable to ø32 to ø100	
MWB	Cylinder with lock	MWB	Double acting, Single rod		
		MWBW	Double acting, Double rod		
	Lock unit	MWB-UT	—	Both sides are equipped with a coil scraper	
CNA2	Cylinder with lock	CNA2	Double acting, Single rod		
CNG	Cylinder with lock	CNG	Double acting, Single rod		
CLS	Cylinder with lock	CLS	Double acting, Single rod	Applicable to ø125 to ø160 (ø180 to ø250 as standard)	
CLQ	Compact cylinder with lock	CLQ	Double acting, Single rod	Applicable to ø40 to ø100	
MGP	Compact guide cylinder	MGPM-Z	Double acting	Applicable to ø20 to ø100	
		MGPL-Z	Double acting	Applicable to ø20 to ø100	
		MGPA-Z	Double acting	Applicable to ø20 to ø100	
MGG	Guide cylinder	MGG	Double acting	Applicable to ø32 to ø100	
MGC	Guide cylinder	MGC	Double acting	Applicable to ø32 to ø50	

Web Catalog

How to Order

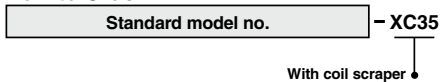

* For MGP series, refer to page 1542.

Specifications: Same as standard type

Made to Order Common Specifications: -XC35: With Coil Scraper



39 With Coil Scraper

Symbol
-XC35

Dimensions (Dimensions other than below are the same as standard type.)

CG1-Z1 series CG1-Z series

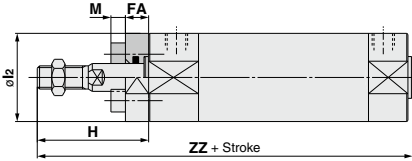

Bore size	Stroke range		FA	H		I ₂	M	ZZ	
	CG1-Z1	CG1-Z		Male thread	Female thread			Male thread	Female thread
20	Up to 200 (up to 1500)	Up to 300 (up to 1500)	6	39	27	26	4	110 (118)	98 (106)
25			6	44	28	31	5	115 (123)	99 (107)
32	Up to 1000	Up to 300 (up to 1500)	6	44	28	38	5	117 (125)	101 (109)
40			7	54	29	47	3.5	134 (143)	109 (118)
50			7	62	30	58	4.5	154 (166)	122 (134)
63			7	62	30	72	5.5	154 (166)	122 (134)

Note) (): CG1-Z long stroke

* On the axial foot and rod side flange types, the mounting bracket is wedged and bolted between the cylinder and the scraper at the time of shipment. Others are shipped together (but not assembled).

The dimensions of the CS2 series are the same as the standard type.

MB series

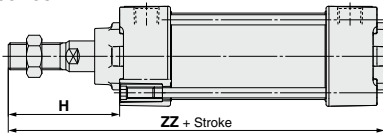

Bore size	H	ZZ
32	47	135
40	58	146
50	67	165
63	67	165
80	81	199
100	81	199

MB1 series

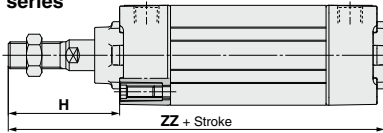

Bore size	H	ZZ
32	47	135
40	58	146
50	67	165
63	67	165
80	81	199
100	81	199

CS1 series

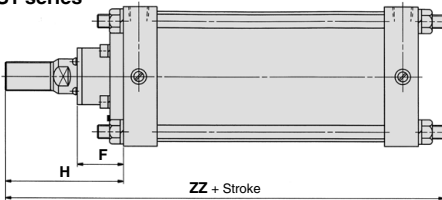

Bore size	Without auto switch			With auto switch		
	F	H	ZZ	F	H	ZZ
125	50	120	245	50	120	245
140	50	120	245	50	120	245
160	50	130	266.5	50	130	266.5
180	55	145	291	55	145	295
200	55	145	291	55	145	300
250	69	175	357.5	—	—	—
300	69	190	387.5	—	—	—

CS2 series Bore sizes ø125 to ø160 have the same dimensions as the standard type.

ø180 to ø250

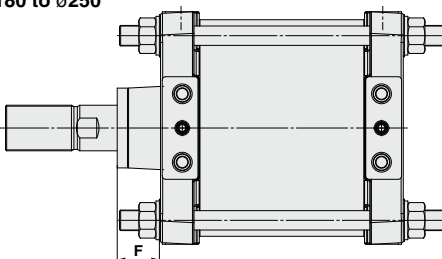

Bore size	F
180	37
200	41
250	52

Made to Order Common Specifications: -XC35: With Coil Scraper



39 With Coil Scraper

Symbol
-XC35

Dimensions (Dimensions other than below are the same as standard type.)

CQ2 series

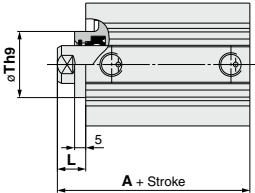

Bore size	A			L		T
	Standard type, Axial piping type		Long stroke	Standard type, Axial piping type	Long stroke	
	50 stroke or less	75, 100 stroke	125 to 300 stroke	100 stroke or less	125 to 300 stroke	
32	35 (45)	45	62.5	12	17	23 ⁺⁰ _{-0.062}
40	41.5 (51.5)	51.5	72	12	17	28 ⁺⁰ _{-0.062}
50	43.5 (53.5)	53.5	73.5	13	18	35 ⁺⁰ _{-0.062}
63	49 (59)	59	75	13	18	35 ⁺⁰ _{-0.062}
80	58.5 (68.5)	68.5	86	15	20	43 ⁺⁰ _{-0.062}
100	70 (80)	80	97.5	17	22	59 ⁺⁰ _{-0.074}

* (): Denotes the dimensions with auto switch magnet.

Made to Order Common Specifications: -XC35: With Coil Scraper



39 With Coil Scraper

Symbol
-XC35

Dimensions (Dimensions other than below are the same as standard type.)

CQ2W series

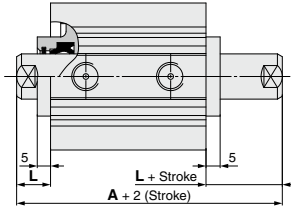

Bore size	A		L
	50 stroke or less	75, 100 stroke	
32	54.5 (64.5)	64.5	12
40	64 (74)	74	12
50	66.5 (76.5)	76.5	13
63	68 (78)	78	13
80	81 (91)	91	15
100	94.5 (104.5)	104.5	17

* () : Denotes the dimensions with auto switch magnet.

RQ series

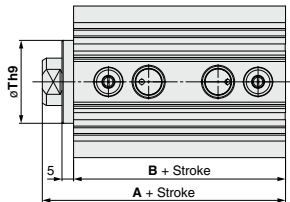

Bore size (mm)	A	B	Th9
32	49	37	23 ⁰ _{-0.052}
40	56	44	28 ⁰ _{-0.052}
50	62.5	49.5	35 ⁰ _{-0.062}
63	68	55	35 ⁰ _{-0.062}
80	78.5	63.5	43 ⁰ _{-0.062}
100	93	76	59 ⁰ _{-0.074}

CBA2 series

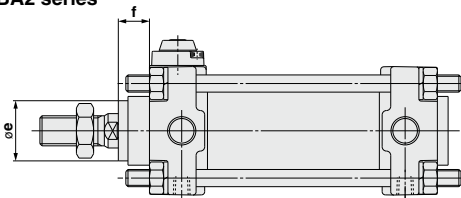

Bore size (mm)	øe	f	
		With rod side locking.	With both-side locking
40	28		14.5
50	32		16.5
63	32		14
80	37		16
100	44		17.5

The above diagram shows the rod side locking and manual releasing non-locking types.
The CBA2 series head side locking type is the same as the standard type.
The dimensions of the manual releasing non-locking type are the same as indicated above.

CNG series

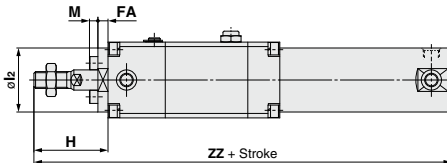

Bore size (mm)	FA	M	l ₂	H	ZZ
20	6	4	26	39	182
25	6	5	31	44	197
32	6	5	38	44	200
40	7	3.5	47	54	225
					ZZ
					190
					205
					208
					234

* Other dimensions are the same as the standard type. (The figure shows a type with a rubber bumper.)

* On the axial foot and rod side flange types, the mounting bracket is wedged and bolted between the cylinder and the scraper at the time of shipment.

CNA2 series

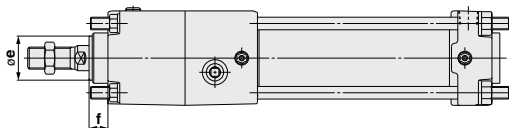

Bore size (mm)	e	f
40	28	12
50	32	12.5
63	32	12.5
80	37	16.5
100	44	17

Made to Order Common Specifications: -XC35: With Coil Scraper



39 With Coil Scraper

Symbol
-XC35

Dimensions (Dimensions other than below are the same as standard type.)

MNB series

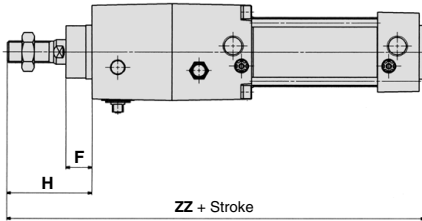

Bore size (mm)	F	H	ZZ
32	16	47	205
40	18	56	221
50	19	63	250
63	19	63	264
80	25	77	326
100	25	77	346

CLS series

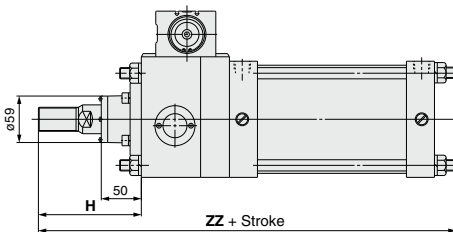

Bore size (mm)	H	ZZ
125	120	355
140	120	355
160	130	398.5

* ø180 to ø250: A coil scraper is attached as standard.

CLQ series

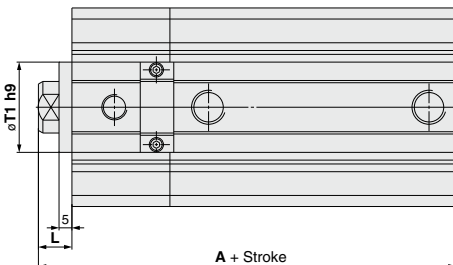

Bore size (mm)	Stroke range (mm)	A		L	T1 h9
		Without auto switch	With auto switch		
40	10 to 50	75.5	85.5	12	28 ⁰ _{-0.052}
	75,100	85.5			
50	10 to 50	78.5	88.5	13	35 ⁰ _{-0.062}
	75,100	88.5			
63	10 to 50	87	97	13	35 ⁰ _{-0.062}
	75,100	97			
80	10 to 50	101.5	111.5	15	43 ⁰ _{-0.062}
	75,100	111.5			
100	10 to 50	120	130	17	59 ⁰ _{-0.074}
	75,100	130			

Made to Order Common Specifications: -XC35: With Coil Scraper



39 With Coil Scraper

Symbol
-XC35

How to Order

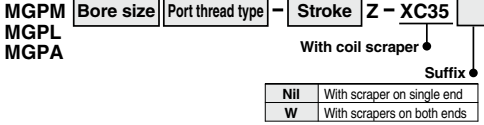

Specifications

Applicable series		MGPM	MGPL, MGPA
Bearing type		Slide bearing	Ball bushing bearing
Bore size (mm)		20, 25, 32, 40, 50, 63, 80, 100	
Minimum operating pressure	With single end	0.12 MPa	
	With both ends	0.14 MPa	
Specifications other than above		Same as standard type	

Dimensions (Dimensions other than below are the same as standard type.)

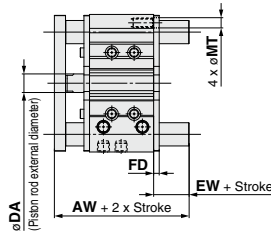
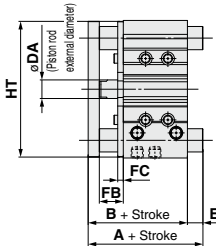

For cylinder with both sides scraper

Common Dimensions:

Bore size (mm)	MGPM, MGPL, MGPA (mm)				
	B	DA	FB	FC	
				MGPM	MGPL, MGPA
20	63	10	18	5	5
25	63.5	10	17	6	5
32	69.5	14	22	6	5
40	76	14	22	6	5
50	82	20	26	6	5
63	87	20	26	6	5
80	106.5	25	34	8	6
100	126	30	41	9	6

With Both Sides Scraper Dimensions:

Bore size (mm)	AW, EW, FD, MT (mm)			
	AW	EW	FD	MT
20	74	6	5	6
25	74.5	6	5	7
32	82.5	7	6	9
40	89	7	6	8.5
50	95	7	6	11
63	100	7	6	11
80	120.5	8	6	14
100	143	8	9	16

MGPM (Slide bearing) A, E, HT Dimensions (mm)

Bore size (mm)	A			E			HT
	50 st or less	Over 50 st to 200 st	Over 200 st	50 st or less	Over 50 st to 200 st	Over 200 st	
20	63	87.5	120	0	24.5	57	80
25	63.5	87.5	119.5	0	24	56	93
32	85	103.5	139.5	15.5	34	70	110
40	85	103.5	139.5	9	27.5	63.5	118
50	98.5	119.5	160.5	16.5	37.5	78.5	146
63	98.5	119.5	160.5	11.5	32.5	73.5	160
80	114.5	141.5	190.5	8	35	84	199
100	136.5	161.5	200.5	10.5	35.5	74.5	236

MGPL, MGPA (Ball bushing bearing) A, E, HT Dimensions (mm)

Bore size (mm)	A				E				HT
	30 st or less	Over 30 st to 100 st	Over 100 st to 200 st	Over 200 st	30 st or less	Over 30 st to 100 st	Over 100 st to 200 st	Over 200 st	
20	69	86	110	127.5	6	23	47	64.5	80
25	75.5	91.5	110.5	127.5	12	28	47	64	93

Bore size (mm)	A				E				HT
	50 st or less	Over 50 st to 100 st	Over 100 st to 200 st	Over 200 st	50 st or less	Over 50 st to 100 st	Over 100 st to 200 st	Over 200 st	
32	89.5	106.5	126.5	148.5	20	37	57	79	110
40	89.5	106.5	126.5	148.5	13.5	30.5	50.5	72.5	118
50	101.5	122.5	142.5	169.5	19.5	40.5	60.5	87.5	146
63	101.5	122.5	142.5	169.5	14.5	35.5	55.5	82.5	160

Bore size (mm)	A				E				HT
	25 st or less	Over 25 st to 50 st	Over 50 st to 200 st	Over 200 st	25 st or less	Over 25 st to 50 st	Over 50 st to 200 st	Over 200 st	
80	114.5	138.5	168.5	201.5	8	32	62	95	199
100	129.5	155.5	188.5	211.5	3.5	29.5	62.5	85.5	236

Made to Order Common Specifications: -XC35: With Coil Scraper



39 With Coil Scraper

Symbol
-XC35

How to Order

MGG -XC35
MGC -XC35
With coil scraper ●

Specifications: Same as the standard type of each series

Note 1) Except $\phi 20$ and $\phi 25$

Note 2) Coil scrapers are attached to the piston rod and guide rods (front and back).

Dimensions (Dimensions other than below and the MGG□B series ($\phi 63$ to $\phi 100$) are the same as standard type.)

MGG□B series

$\phi 32$ to $\phi 50$

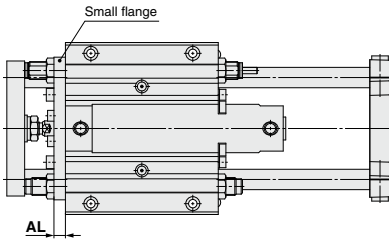

(mm)	
Bore size (mm)	AL
32	9
40	12
50	12

MGC□B series

$\phi 32$ to $\phi 50$

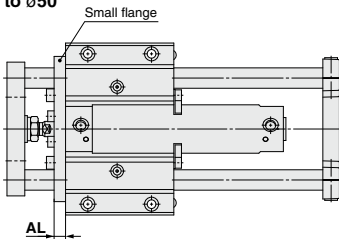

(mm)	
Bore size (mm)	AL
32	9
40	12
50	12

Made to Order Common Specifications:

- XC36: With Boss in Rod Side
- XC37: Larger Throttle Dia. of Connection Port



40 With Boss in Rod Side

Symbol
-XC36

Cylinder with boss in rod side

Applicable Series

Series	Description	Model	Action	Vol. no. (for std. model)
CQS	Compact cylinder	CQS	Double acting, Single rod Single acting (Spring return/extend)	Web Catalog
		CQSW	Double acting, Double rod	
CQ2	Compact cylinder	CQ2-Z	Double acting, Single rod Single acting (Spring return/extend)	
		CQ2W-Z	Double acting, Double rod	
		CQ2	Double acting, Single rod	
	Long stroke <small>Note 4)</small>	CQ2K	Double acting, Single rod	
		CQ2KW	Double acting, Double rod	
	Non-rotating rod <small>Note 4)</small>	CQP2	Double acting, Single rod Single acting (Spring return/extend)	
Axial piping type (Centralized piping type)				

Note 1) For the double rod type, it comes with boss for both sides.

Note 2) Except with bracket

Note 3) $\sigma 125$ or more is excluded in CQ2.

Note 4) The standard model can be used for long strokes and non-rotating rod types (single rod or double rod).

How to Order

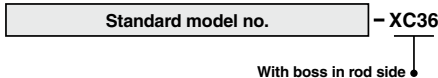

Specifications: Same as standard type

Dimensions

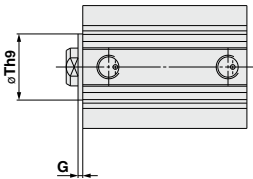

* Dimensions except mentioned above are the same as standard type.

Series	CQ2		CQS	
	Th9	G	Th9	G
12	15 ⁰ _{-0.043}	1.5	15 ⁰ _{-0.043}	1.5
16	20 ⁰ _{-0.052}	1.5	20 ⁰ _{-0.052}	1.5
20	13 ⁰ _{-0.043}	2	13 ⁰ _{-0.043}	2
25	15 ⁰ _{-0.043}	2	15 ⁰ _{-0.043}	2
32	21 ⁰ _{-0.052}	2	—	—
40	28 ⁰ _{-0.052}	2	—	—
50	35 ⁰ _{-0.062}	2	—	—
63	35 ⁰ _{-0.062}	2	—	—
80	43 ⁰ _{-0.062}	2	—	—
100	59 ⁰ _{-0.074}	2	—	—

41 Larger Throttle Diameter of Connection Port

Symbol
-XC37

This is a cylinder with a piping port larger than the standard type.

Applicable Series

Series	Description	Model	Action	Vol. no. (for std. model)
CG1	Air cylinder	CG1-Z	Double acting, Single rod	Web Catalog
	Double rod type	CG1W-Z	Double acting, Double rod	
MGG	Guide Cylinder	MGG	Double acting	
MGC	Guide Cylinder	MGC	Double acting	

Note 1) Except $\sigma 80$, 100

How to Order

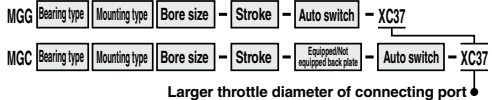
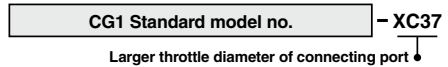

Specifications: Same as standard type

Dimensions (Throttle diameter of connection port)

Dimensions other than below are the same as standard type.

CG1 Series (mm)

Bore size (mm)	With rubber bumper	With air cushion	Standard type
20	5	3	(2.1)
25	5	3.5	(2.5)
32	6	6	(3.3)
40	7	7	(3.9)
50	9	9	(4.5)
63	9	9	(5.7)

* Use external stopper, etc. not to be damaged with cylinder cover directly if exceeding the range of kinetic energy absorption.

MGG Series (mm)

Bore size (mm)	Throttle dia. (ø)
20	5
25	5
32	6
40	7
50	9
63	9

MGC Series (mm)

Bore size (mm)	Throttle dia. (ø)
20	3
25	3.5
32	6
40	7
50	9

Made to Order Common Specifications: -XC38: Vacuum (Rod through-hole)



42 Vacuum (Rod through-hole)

Symbol
-XC38

Through-hole of hollow rod can be used as the passage of vacuum air.

Applicable Series

Series	Description	Model	Action	Note	Vol. no. (for std model)
CM2	Air cylinder/Standard type	CM2W-Z	Double acting, Double rod		Web Catalog
MTS	Precision cylinder	MTS	Double acting, Single rod	Available only for ø8 female thread	

How to Order

CM2 Standard model no.

-XC38

Vacuum (Rod through-hole)



Construction/Dimensions

(Other dimensions are the same as standard.)

CM2W series

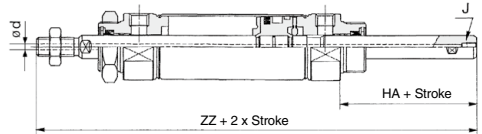

Bore size (mm)	d	J	HA	ZZ
20	3	M5 x 0.8	32	135
25	3	M5 x 0.8	32	139
32	3	M5 x 0.8	32	141
40	4	Rc1/8	36	174

Specifications: Same as standard type

MTS8 - Stroke (P) - XC38

Axial piping type

Vacuum (Rod through-hole)



Dimensions

MTS8 series

Use ø4/ø2.5 urethane tube (TU0425) or use soft nylon tube (TS0425).

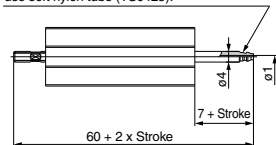

⚠ Caution

1. Blow air for through-hole.

Flush the through-hole which is a passage for air pressure and vacuum to prevent dust.

Specifications

Bore size (mm)	8
Piping direction	Standard piping type, Axial piping type
Rod end configuration	Female thread

Made to Order Common Specifications: -XC42: Built-in Shock Absorber in Head Cover Side



43 Built-in Shock Absorber in Head Cover Side

Symbol
-XC42

A type of the CG1 series air cylinder in which a special shock absorber is enclosed in the head portion so that its ability to absorb energy during the retraction of the cylinder is considerably greater than the current air cushion.

Applicable Series

Series	Description	Model	Action	Note	Vol. no. (for std model)
CG1	Air cylinder	CG1-Z	Double acting, Single rod	Except head side trunnion and clevis types	Web Catalog

How to Order

CG1 Standard model no. -XC42
Built-in shock absorber in head cover side ↓



Specifications

Piston speed	50 to 1000 mm/s
Additional specifications	Same as standard type

* On the axial foot and head side flange types, the bracket is mounted at the time of shipment. Others are shipped together (but not assembled).

Construction/Dimensions (Other dimensions are the same as CG1 long stroke cylinder.)

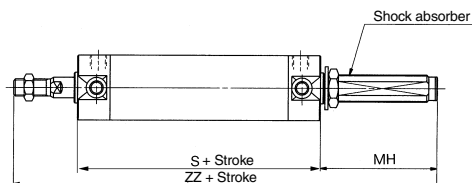

The shock absorber service life is different from that of the CG1 cylinder. Refer to the RB series Specific Product Precautions for the replacement period.

(mm)					
Bore (mm)	Stroke range	Shock absorber	S	MH	ZZ
20	10 to 350	RBAC0806	77	23.5	135.5
25	10 to 400	RBAC1007	77	31	148
32	15 to 450	RBAC1412	79	55	174
40	15 to 800	RBAC2015	87	62.5	199.5
50	15 to 1200	RBAC2015	102	55.5	215.5
63	25 to 1200	RBAC2725	102	92.5	252.5

* Shock absorbers are consumables.

The specifications for shock absorbers are the same as RBC□□□□, but use RBAC□□□□ when an external pressure is applied such as for a built-in cylinder.

The maximum absorption energy may decrease depending on the operating conditions.

Made to Order Common Specifications: -XC51: With Hose Nipple -XC52: Mounting Nut with Set Screw



44 With Hose Nipple

Symbol

-XC51

The one with hose nipple attached in order to save time for assembly at the time of shipment.

Applicable Series

Series	Description	Model	Action	Vol. no. (for std model)
CJ2	Air cylinder	CJ2-Z	Double acting, Single rod Single acting (Spring return)	Web Catalog
		CJ2W-Z	Double acting, Double rod	
	Non-rotating rod type	CJ2K-Z	Double acting, Single rod Single acting (Spring return)	
		CJ2Z-Z	Double acting, Single rod	
	With speed controller	CJ2Z-Z	Double acting, Single rod	
		CJ2W-Z	Double acting, Double rod	
Direct mount type	CJ2RA-Z	Double acting, Single rod Single acting (Spring return)		
		Double acting, Single rod Single acting (Spring return)		
Non-rotating rod, Direct mount type	CJ2RK-Z	Double acting, Single rod Single acting (Spring return)		
		Double acting, Single rod Single acting (Spring return)		

45 Mounting Nut with Set Screw

Symbol

-XC52

In order to prevent the mounting nut from being loosen, set screw should be tighten from the two directions to fix the mounting nut.

Applicable Series

Series	Description	Action	Action	Vol. no. (for std model)
CM2	Air cylinder	CM2-Z	Double acting, Single rod Single acting (Spring return)	Web Catalog
		CM2W-Z	Double acting, Double rod	
	Non-rotating rod type	CM2K-Z	Double acting, Single rod Single acting (Spring return)	
		CM2KW-Z	Double acting, Double rod	
	Centralized piping type	CM2CP-Z	Double acting, Single rod	
	End lock cylinder	CBM2	Double acting, Single rod	
Smooth cylinder	CM2Y-Z	Double acting, Single rod		
Low speed cylinder	CM2X-Z	Double acting, Single rod		

How to Order

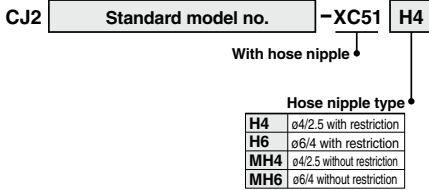

How to Order

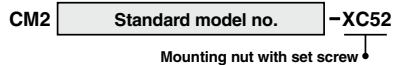

Specifications: Same as standard type

Specifications: Same as standard type

Dimensions

(Dimensions other than below are the same as standard type.)

Applicable Hose Nipple Type

Symbol	Applicable bore size (mm)	Function	Hose nipple part no.
H4	ø4/2.5	With a fixed orifice (ø0.8)	CJ-5H-4
H6	ø6/4		CJ-5H-6
MH4	ø4/2.5	Without fixed orifice	M-5H-4
MH6	ø6/4		M-5H-6

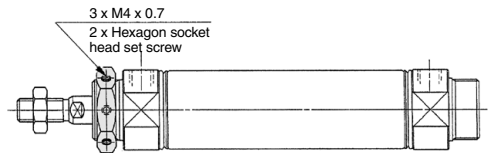

Dimensions

(Dimensions other than below are the same as standard type.)

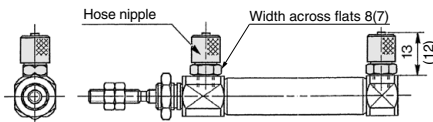

* The above figure shows the ø6/4 hose nipple mounting dimensions. The dimensions in () show those for the ø4/2.5 hose nipple.

Made to Order Common Specifications: -XC56: With Knock Pin Holes



46 With Knock Pin Holes

Symbol
-XC56

Cylinder with knock positioning pin hole.

Applicable Series

Series	Description	Model	Action	Note	Vol. no. (for std. model)
MGPW	Compact guide cylinder	MGPW	Double acting		Web Catalog
MGG	Guide cylinder	MGG ^M B	Double acting	For basic type only	
MGC	Guide cylinder	MGC ^M B	Double acting	For basic type only	
MGQ	Compact guide cylinder	MGQ	Double acting	For basic type only	
MY	Mechanically jointed rodless cylinder	MY1H-Z	Linear guide		
		MY1C	Cam follower guide		
		MY1H	Linear guide		
		MY2H	Linear guide type (Single axis)		
		MY2HT	Linear guide type (Double axis)		

How to Order

Standard model no. **-XC56**
 With knock pin holes

Specifications: Same as standard type

Dimensions (Dimensions other than below are the same as standard type.)

MGPW series

ø20 to ø63

Upper view of plate

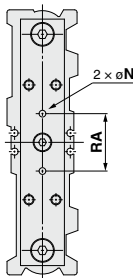

Side view (lower surface) of cylinder

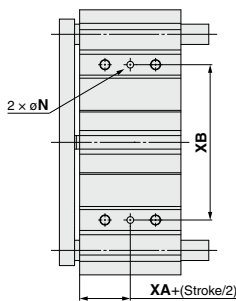

Bottom view of cylinder

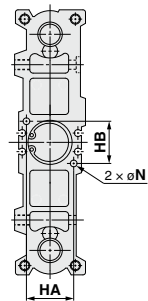

MGPW Series

(mm)

Bore size (mm)	HA	HB	N	RA	XA	XB
20	25±0.02	25±0.02	3 ^{H7} / ₀ ^{+0.010} depth 6	28±0.02	17	76±0.03
25	28±0.02	28±0.02	4 ^{H7} / ₀ ^{+0.012} depth 6	34±0.02	18	92±0.03
32	34±0.02	34±0.02	4 ^{H7} / ₀ ^{+0.012} depth 6	42±0.02	19	112±0.03
40	38±0.02	38±0.02	4 ^{H7} / ₀ ^{+0.012} depth 6	50±0.02	21	128±0.04
50	49±0.02	49±0.02	5 ^{H7} / ₀ ^{+0.012} depth 8	66±0.03	21	168±0.04
63	58±0.03	58±0.03	5 ^{H7} / ₀ ^{+0.012} depth 8	80±0.03	25	196±0.04

Made to Order Common Specifications: -XC56: With Knock Pin Holes



46 With Knock Pin Holes

Symbol
-XC56

Dimensions (Dimensions other than below are the same as standard type.)

MGG series

ø20 to ø50

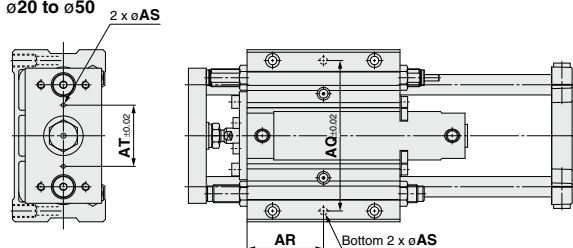

MGG Series

(mm)

Bore size (mm)	AQ	AR	AS	AT
20	92	45	5 ^{HT} ₀ ^{+0.012} depth 6	36
25	113	50	6 ^{HT} ₀ ^{+0.012} depth 8	45
32	118	60	6 ^{HT} ₀ ^{+0.012} depth 8	48
40	150	70	8 ^{HT} ₀ ^{+0.015} depth 11	56
50	170	85	10 ^{HT} ₀ ^{+0.015} depth 13	68
63	200	100	10 ^{HT} ₀ ^{+0.015} depth 13	74
80	234	115	12 ^{HT} ₀ ^{+0.018} depth 15	92
100	274	140	12 ^{HT} ₀ ^{+0.018} depth 15	106

ø63 to ø100

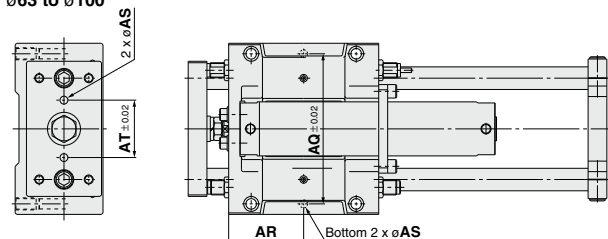

MGC series

ø20 to ø50

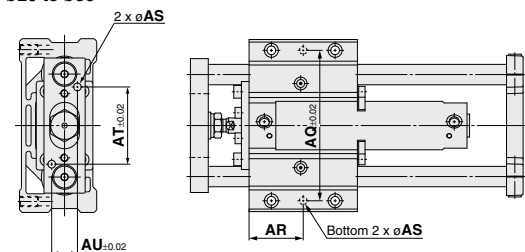

MGC Series

(mm)

Bore size (mm)	AQ	AR	AS	AT	AU
20	90	37.5	5 ^{HT} ₀ ^{+0.012} depth 6	45	15
25	103	40	6 ^{HT} ₀ ^{+0.012} depth 8	55	20
32	118	42.5	6 ^{HT} ₀ ^{+0.012} depth 8	60	20
40	140	47.5	8 ^{HT} ₀ ^{+0.015} depth 11	70	22
50	170	65	8 ^{HT} ₀ ^{+0.015} depth 11	85	30

MGQ series

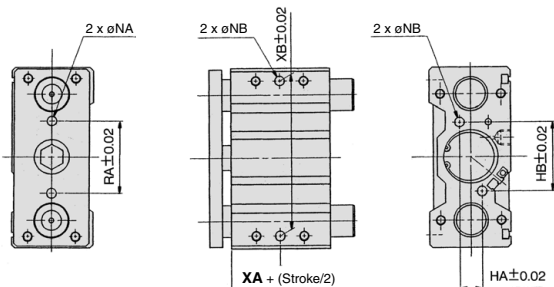

MGQ Series

(mm)

Bore size (mm)	HA	HB	NA	NB	RA	XA	XB
12	0	19	3 ^{HT} ₀ ^{+0.012} depth 4	3 ^{HT} ₀ ^{+0.012} depth 4	21	14.5	50
16	7	22	3 ^{HT} ₀ ^{+0.012} depth 4	3 ^{HT} ₀ ^{+0.012} depth 4	22	16.5	54
20	9	26	4 ^{HT} ₀ ^{+0.012} depth 5	4 ^{HT} ₀ ^{+0.012} depth 5	28	18	64
25	12	30	4 ^{HT} ₀ ^{+0.012} depth 5	6 ^{HT} ₀ ^{+0.012} depth 5	34	19	76
32	14	44	6 ^{HT} ₀ ^{+0.012} through	6 ^{HT} ₀ ^{+0.012} depth 8	46	18.5	100
40	14	54	6 ^{HT} ₀ ^{+0.012} through	6 ^{HT} ₀ ^{+0.012} depth 8	50	22	110
50	20	62	8 ^{HT} ₀ ^{+0.015} through	8 ^{HT} ₀ ^{+0.015} depth 11	56	22	124
63	30	74	8 ^{HT} ₀ ^{+0.015} through	8 ^{HT} ₀ ^{+0.015} depth 11	66	24	132
80	36	94	10 ^{HT} ₀ ^{+0.018} through	10 ^{HT} ₀ ^{+0.018} depth 13	84	28.5	166
100	40	116	10 ^{HT} ₀ ^{+0.018} through	10 ^{HT} ₀ ^{+0.018} depth 13	110	32.5	200

Made to Order Common Specifications: -XC56: With Knock Pin Holes



46 With Knock Pin Holes

Symbol
-XC56

Dimensions (Dimensions other than below are the same as standard type.)

MY1C series

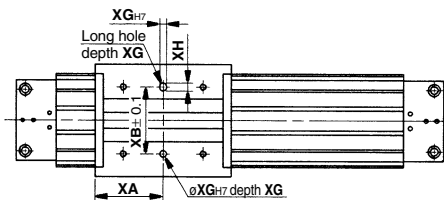

Mounting surface of a workpiece for the slide table

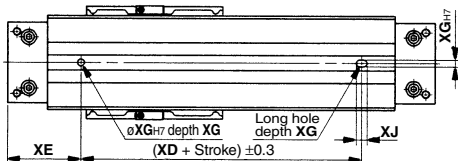

Mounting surface of cylinder tube

Bore size (mm)	XA	XB	XD	XE	XG	XH	XJ
16	40	40	80	40	4	5	9
20	50	40	100	50	4	5	9
25	51	50	110	55	5	6	10
32	66	60	140	70	6	7	11
40	81	80	180	80	6	7	11
50	100	90	230	85	8	9	13
63	115	110	280	90	10	10	15

MY1H-Z series

$\phi 25, \phi 32, \phi 40$

MY1H series

$\phi 10, \phi 16, \phi 20$

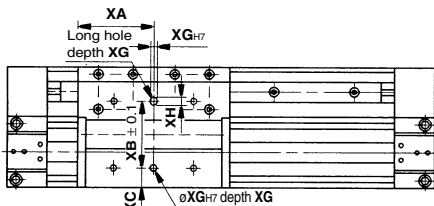

Mounting surface of a workpiece for the slide table

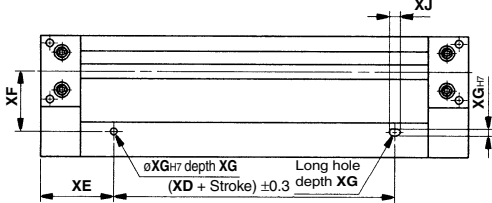

Mounting surface of cylinder tube

Bore size (mm)	XA	XB	XC	XD	XE
10	25	33	3.5	70	20
16	40	40	7.5	80	40
20	50	40	14.5	100	50
25	57	50	14.5	110	55
32	70	60	15	140	70
40	85	80	20.5	180	80

Bore size (mm)	XF	XG	XH	XJ
10	21.5	3	4	5
16	30	4	5	7
20	39	4	5	7
25	45	5	6	8
32	60	6	7	9
40	60.5	6	7	9

Made to Order Common Specifications: -XC56: With Knock Pin Holes



46 With Knock Pin Holes

Symbol
-XC56

Dimensions (Dimensions other than below are the same as standard type.)

MY2H series

ø16, ø25, ø40

MY2HT series

ø16, ø25, ø40

* The workpiece mounting surface of the slide table supports knock pin holes as standard.

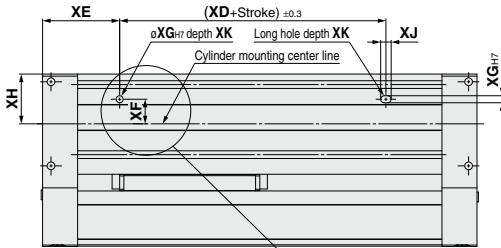

Mounting surface of
cylinder tube

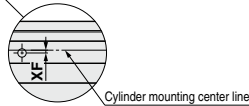

MY2HT16, 25

MY2H series (mm)

Bore size (mm)	XD	XE	XF	XG	XH	XJ	XK
16	80	40	11.5	4	23.5	6	5
25	100	55	17.5	5	35.5	7.5	5
40	170	80	25.5	6	45.5	9	8

MY2HT series (mm)

Bore size (mm)	XD	XE	XF	XG	XH	XJ	XK
16	80	40	3.5	5	43	7.5	5
25	100	55	2	6	61	9	8
40	170	80	3	8	75	12	12

Made to Order Common Specifications: -XC57: Rodless Cylinder with Floating Joint



47 Rodless Cylinder with Floating Joint

Symbol
-XC57

A special floating joint has been added to the CY3B series, which reduces the amount of labor that is required for connecting the cylinder to the guide of another shaft (load side). The bolts used for joining the floating joint to the load can be secured either from above or below. (CY3B (-Z) with a $\phi 6$ or $\phi 10$ bore must be secured from above.)

Applicable Series

Series	Description	Model	Action	Vol. no. (for std model)
CY3	Magnetically coupled rodless cylinder	CY3B-Z	Double acting	Web Catalog
		CY3B	Double acting	
		CY3R	Double acting	
REA	Sine rodless cylinder	REA	Double acting	
		REAR	Double acting	
REB	Sine rodless cylinder	REBR	Double acting	

How to Order

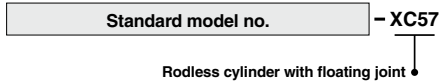

Note) The body of this cylinder is for connecting to the floating joint so that it cannot be connected to the body of the standard type.

Specifications: Same as standard type

Made to Order Common Specifications: -XC57: Rodless Cylinder with Floating Joint



47 Rodless Cylinder with Floating Joint

Symbol
-XC57

Construction/Dimensions (Other dimensions are the same as standard.)

CY3B-Z, CY3B series

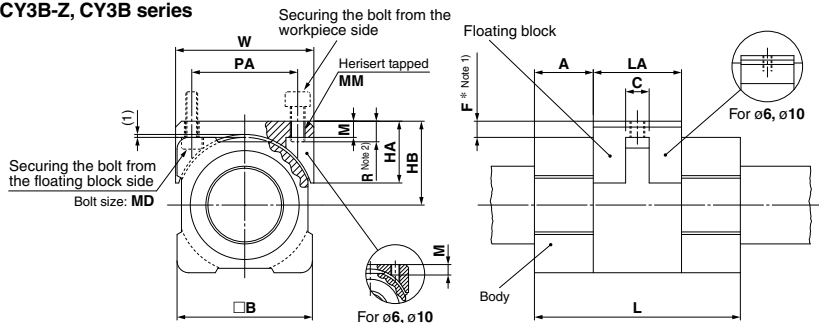

REA series

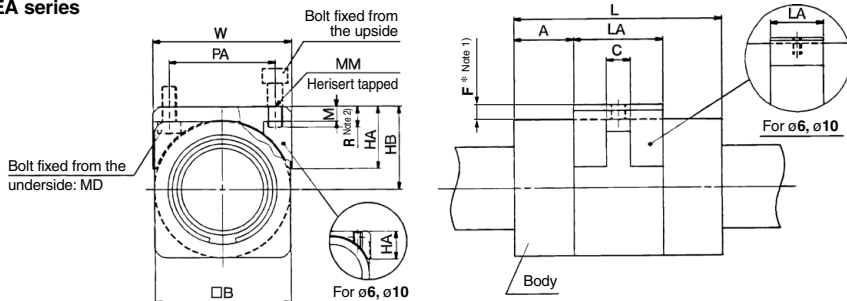

Bore size (mm)	A	□B	C	F ⁽¹⁾	HA	HB	L	LA	MM	MD	M	PA	R ⁽²⁾	W
6	10	17	—	2.5	6.3	11	35	15	M3 x 0.5 x 3L	—	3	12	—	18
10	10	25	—	2.5	9.5	15	38	18	M3 x 0.5 x 3L	—	3.5	17	—	26
15	16	35	6.5	5.5	16.5	23	57	25	M4 x 0.7	M3	4.5	25	6	36
20	18	36	6.5	5.5	17	23.5	66	30	M4 x 0.7	M3	4.5	27	6	37
25	20	46	8.0	5.5	21	28.5	70	30	M5 x 0.8	M4	5.5	36	7	47
32	22.5	60	9.5	6.0	27.5	36	80	35	M6 x 1.0	M5	6.5	47	8	61
40	26	70	9.5	6.0	28.5	41	92	40	M6 x 1.0	M5	6.7	55	8	71
50	35	86	11	6.0	35	49	110	40	M8 x 1.25	M6	8.5	65	11	87
63	36	100	18	7.0	42	57	122	50	M8 x 1.25	M6	10	80	11	101

Note 1) With dimension F¹, the amount of clearance between the body and the floating joint is 1 mm. The self weight deflection of the cylinder tube is not taken into account. Before operating the cylinder, determine the proper value by taking the amount of self weight deflection and the amount of off-centering from the other shaft into consideration.

Note 2) When the bolts are secured from above, be aware that if the cylinder is operated when dimension R (on ø6 and ø10, 3 mm or over) is exceeded, the end of the bolt could come in contact with the body, without being able to achieve the floating effect.

Made to Order Common Specifications: -XC57: Rodless Cylinder with Floating Joint



47 Rodless Cylinder with Floating Joint

Symbol
-XC57

Construction/Dimensions

CY3R series
REAR, REBR series

For $\phi 6$, $\phi 10$, $\phi 15$

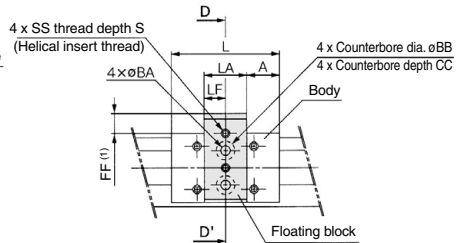
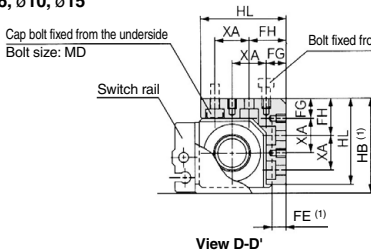

For $\phi 20$, $\phi 25$, $\phi 32$, $\phi 40$, $\phi 50$, $\phi 63$

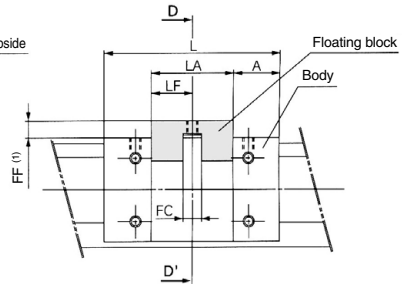
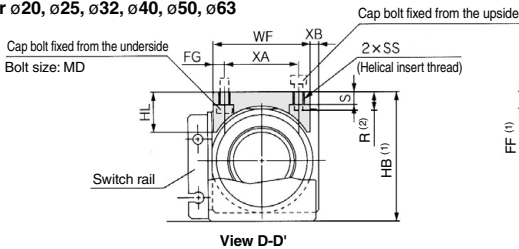

Bore size (mm)	A	BA	BB	CC	FC	FE ⁽¹⁾	FF ⁽¹⁾	FG	FH	HB ⁽¹⁾	HL	L	LA	LF	MD	R ⁽²⁾	S	SS	WF	XA	XB
6	9.5	3.4	6.5	3.3	—	5	7	5.5	10.5	26	23	34	15	7.5	M3	—	3.5	M3 x 0.5	—	10	—
10	11.5	3.4	6.5	3.3	—	5	7	7	13	33	30	38	15	7.5	M3	—	3.5	M3 x 0.5	—	12	—
15	18	4.5	8	4.4	—	4.5	6.5	7.5	14.5	38.5	35.5	53	17	8.5	M4	—	4.5	M4 x 0.7	—	14	—
20	16.5	—	—	—	6.5	—	6	4	—	45	14	62	29	14.5	M3	7	4.5	M4 x 0.7	34	26	3
25	20.5	—	—	—	8	—	7	4	—	51	17	70	29	14.5	M4	8	5.5	M5 x 0.8	39	31	3
32	21	—	—	—	9.5	—	7.5	4.5	—	62.5	22	76	34	17	M5	10	6.5	M6 x 1	50	41	3
40	25.5	—	—	—	9.5	—	7.5	7.5	—	74.5	28	90	39	19.5	M5	10	6.5	M6 x 1	60	45	3
50	35.5	—	—	—	11	—	7.5	9	—	92.5	38	110	39	19.5	M6	15	10	M8 x 1.25	78	60	3
63	34.5	—	—	—	18	—	7.5	10	—	104.5	39	118	49	24.5	M6	15	10	M8 x 1.25	90	70	3

Note 1) With dimension FE, FF, and HB, the amount of clearance between the body and the floating joint is 1 mm. The self weight deflection of the cylinder tube is not taken into account. Before operating the cylinder, determine the proper value by taking the amount of self weight deflection and the amount of off-centering with the other shaft into consideration.

Note 2) When the bolts are secured from above, be aware that if the cylinder is operated when dimension R is exceeded, the end of the bolt could come in contact with the body, without being able to achieve the floating effect.

Made to Order Common Specifications: -XC65: Made of Stainless Steel (Combination of XC7 and XC68)



48 Made of Stainless Steel (Combination of XC7 and XC68)

Symbol
-XC65

Suitable for the cases it is likely to generate rust by being immersed in the water and corrosion.

Applicable Series

Series	Description	Model	Action	Note	Vol. no. (for std model)
MB	Air cylinder	MB-Z	Double acting, Single rod	Except ø125	Web Catalog
		MBW-Z	Double acting, Double rod	Except ø125	
	Smooth cylinder	MBY-Z	Double acting, Single rod		
MB1	Air cylinder	MB1-Z	Double acting, Single rod	Except ø125	
		MB1W-Z	Double acting, Double rod	Except ø125	
CA2	Air cylinder	CA2-Z	Double acting, Single rod		
		CA2W-Z	Double acting, Double rod		
	Air-hydro cylinder	CA2H	Double acting, Single rod		
		CA2HW	Double acting, Double rod		
	Smooth cylinder	CA2Y-Z	Double acting, Single rod		
CV	Valve mounted cylinder	CV3	Double acting, Single rod		

Specifications

Parts changed to stainless steel	Tie-rod, Tie-rod nut, Bracket mounting nut, Spring washer, Cushion valve, Retaining ring, Piston rod (with hard chrome plated), Rod end nut
Maximum manufacturable stroke (mm)	Double acting, Single rod: 1600 Double acting single rod with rod boot: 1000
Specifications other than above and external dimensions	Same as standard type

How to Order

Standard model no.

- XC65

Made of stainless steel
(Combination of XC7 and XC68)

Made to Order Common Specifications:

-XC67: Dust Seal Band NBR Lining Specifications

-XC68: Made of Stainless Steel (With Hard Chrome Plated Piston Rod)



49 Dust Seal Band NBR Lining Specifications

Symbol
-XC67

The standard vinyl chloride lining specification is changed to NBR lining
Oil resistance and peeling resistance are improved.
Note) Please consult with SMC for specific details on oil resistance.

MY1 **B** **Bore size** - **Stroke** **Stroke adjustment unit** - **Auto switch** **Suffix** -XC67

Series: Bore size

B	Basic type	10	16	20	25	32	40	50	63	80	100
M(W)	Slide bearing type (With cover)	•	•	•	•	•	•	•	•	•	•
C(W)	Cam follower guide type (With cover)	•	•	•	•	•	•	•	•	•	•
H	Linear guide type	•	•	•	•	•	•	•	•	•	•
HT	High rigidity/Linear guide type	•	•	•	•	•	•	•	•	•	•

ø10, ø80 and ø100 are available only in stainless steel plate and the NBR lining specification is not available.

Example) MY1B40G-300L-Z73-XC67

For ordering dust seal band (NBR lining) only

MY **Bore size** - 16 **B** **N** **Stroke**

Dust seal band
NBR lining

Dust seal band
Hexagon socket head set
screw thread treatment

Nil	Black zinc chromated
W	Nickel plated

For details, refer to "Dust seal band" in the construction of each series.

Example) MY25-16BNW-300

Applicable Series

Series	Description	Model	Type	Vol. no. (for std model)
MY	Mechanically jointed rodless cylinder	MY1B	Basic type	Web Catalog
		MY1M(W)	Slide bearing type (With cover)	
		MY1C(W)	Cam follower guide type (With cover)	
		MY1H	Linear guide type	
		MY1HT	High rigidity/Linear guide type	

50 Made of Stainless Steel (With Hard Chrome Plated Piston Rod)

Symbol
-XC68

Suitable for the cases it is likely to generate rust by being immersed in the water and corrosion.

Applicable Series

Series	Description	Model	Action	Vol. no. (for std model)
MB	Standard type	MB-Z	Double acting, Single rod	Web Catalog
		MBW-Z	Double acting, Double rod	
	Smooth cylinder	MBY-Z	Double acting, Single rod	
MB1	Standard type	MB1-Z	Double acting, Single rod	
		MB1W-Z	Double acting, Double rod	
CA2	Standard type	CA2-Z	Double acting, Single rod	
		CA2W-Z	Double acting, Double rod	
	Smooth cylinder	CA2Y-Z	Double acting, Single rod	
CS1	Standard type	CS1	Double acting, Single rod	
CS2	Standard type	CS2	Double acting, Single rod	
		CS2W	Double acting, Double rod	
MWB	Standard type	CS2Y	Double acting, Single rod	
	Lock unit	MWB-UT	—	

How to Order

Standard model no. -XC68

Made of stainless steel
(With hard chrome plated piston rod)

Specifications

Parts changed to stainless steel	Piston rod, Rod end nut
Specifications other than above and external dimensions	Same as standard

Note) A rod end nut (stainless steel) only comes with the series that indicate that a rod end nut is included.

Maximum stroke

Series	Double acting, Single rod	Double acting single rod with rod boot
MB, MB1	1600	1000
CA2	1000	1000

Series	Bore size	Double acting, Single rod	Double acting single rod with rod boot
CS1 CS2	125 to 160	1600	1600
	180	1569	1569
	200	998	998
	250	813	813
	300, 320	495	495

MWB-UT (Lock unit) Stainless Steel Rod Length

Model	Min. length	Max. length	Note
32	250 mm	1800 mm	Can be manufactured in increments of 1 mm up to the maximum length.
40	250 mm	2500 mm	
50	300 mm		
63	300 mm		
80	300 mm		
100	300 mm		

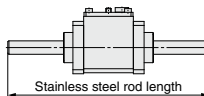

* Rod is shipped together with the product.

Made to Order Common Specifications: -XC69: MGP Series with Shock Absorber



Symbol

-XC69

51 MGP Series with Shock Absorber

Applicable Series

Series	Description	Model	Action	Note	Vol. no. (for std model)
MGP	Compact guide cylinder	MGPM-Z	Double acting	Except ø12 to ø40	Web Catalog
		MGPL-Z	Double acting		
		MGPA-Z	Double acting		

How to Order **MGP** **M** **50** **□** - **50** **Z** - **Z73** **□** - **XC69**

Compact guide cylinder
 Bearing type
 Bore size (mm)
 Port thread type
 Cylinder stroke (mm)
 Auto switch
 Suffix for auto switch
 With shock absorber

M	Slide bearing
L	Ball bushing bearing
A	High precision ball bushing bearing

Specifications of Extension Adjusting Mechanism

Bore size (mm)	50, 63	80, 100
Shock absorber model	RB2015	RB2725
Maximum energy absorption (J)	58.8	147
Stroke adjustment range (mm)	0 to -25	0 to -30
Piston speed	Refer to the graph below.	

Soft type RJ series type (-XB22) is also available.
For details, refer to -XB22.

Allowable Kinetic Energy

Load mass and cylinder speed should be observed within the range given in the graph below.

Stroke retracted side (Rubber bumper)

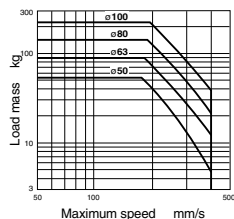

Stroke extended side (Shock absorber)

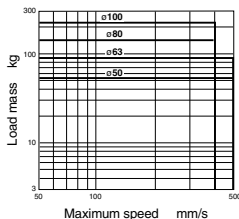

The shock absorber service life is different from that of the MGP cylinder. Refer to the RB series Specific Product Precautions for the replacement period.

Mounting

Do not allow hands or fingers near the cylinder during its operation.

If finger, etc. were to get caught between shock absorber and body, it might damage on the human body and the peripheral equipment. Take protective measures by mounting a protective cover, etc. as necessary.

Basically, avoid bottom-mounting a cylinder.

Mounting space is limited owing to the guide rod and the end plate, etc. Mount a cylinder by the top mounting or side mounting.

Adjustment

1. How to adjust an adjustment screw (Stroke adjustment)

Loosen only the hexagon nut 1, then turn the adjustment screw to adjust the stroke. After adjusting, lock it with the hexagon nut 1. Fix it at the position ejected from the end plate, so that the end face of an adjustment screw could hit the bracket for stopper directly. (Refer to the figure right above.)

2. How to replace shock absorbers

Loosen hexagon nut 2, and turn a shock absorber counterclockwise for removal. After installing a new shock absorber, fix it at the position that the end face of an adjustment screw sticks out by 0.5 mm from a shock absorber. (Refer to the figure on the right.) After adjusting the position of shock absorber, be sure to secure with hexagon nut 2.

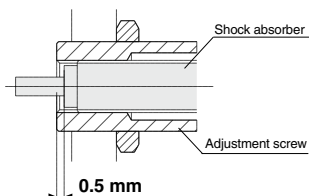
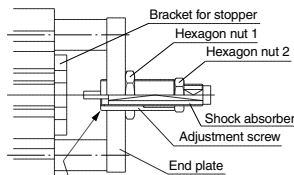

Made to Order Common Specifications: -XC69: MGP Series with Shock Absorber



51 MGP Series with Shock Absorber

Symbol
-XC69

Dimensions (Dimensions other than below are the same as standard type.)

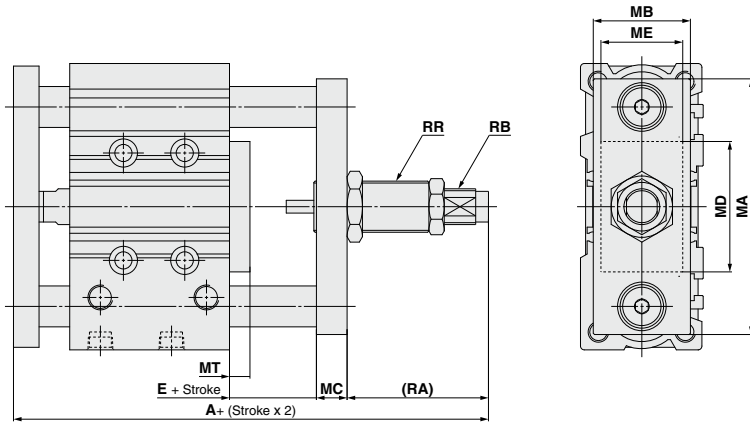

(mm)

Bore size	A	E	MA	MB	MC	MD	ME	MT	RA	RB	RR
50	155	10	139	60	16	71	38	9	57	RJ2015H	M27 x 1.5
63	160	10	153	60	16	84	50	9	57	RJ2015H	M27 x 1.5
80	212.5	17	190	75	22	114	50	16	77	RJ2725H	M36 x 1.5
100	232	17	228	75	25	140	65	16	74	RJ2725H	M36 x 1.5

Made to Order Common Specifications:

-XC71: Helical Insert Thread Specifications

-XC72: Without Built-in Auto Switch Magnet



52 Helical Insert Thread Specifications

Symbol
-XC71

The guide body mounting threads are helical insert threads.

Applicable Series

Series	Description	Model	Action	Note	Vol. no. (for std model)
MGG	Guide cylinder	MGG	Double acting		Web Catalog

How to Order

MGG Bearing type **B** Bore size Port thread type — Stroke — Auto switch — **XC71**

↓ Basic type

↓ Helical insert thread specifications

Specifications

Applicable series	MGG□B
Bore size (mm)	20, 25, 32, 40, 50
Mounting type	Basic type
Specifications other than above	Same as standard type

Dimensions (Dimensions other than below are the same as standard type.)

ø20 to ø50

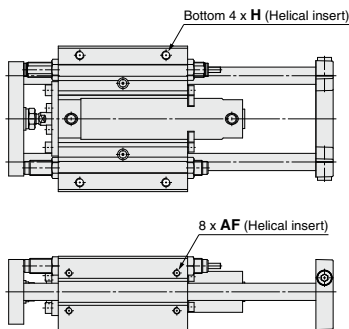

Bore size (mm)	H	AF
20	M6 x 1 depth 12	M5 x 0.8 depth 7.5
25	M8 x 1.25 depth 16	M6 x 1 depth 9
32	M8 x 1.25 depth 16	M6 x 1 depth 9
40	M10 x 1.5 depth 20	M8 x 1.25 depth 12
50	M12 x 1.75 depth 24	M10 x 1.5 depth 15

53 Without Built-in Auto Switch Magnet

Symbol
-XC72

This cylinder type does not have built-in auto switch magnet.

Applicable Series

Series	Description	Model	Action	Note	Vol. no. (for std model)
MGG	Guide cylinder	MGG	Double acting		Web Catalog

How to Order

MGG Standard model no. — **XC72**

↓ Without built-in auto switch magnet

Specifications

Applicable series	MGG
Bore size (mm)	20, 25, 32, 40, 50
Auto switch	Not mountable
Specifications other than above and external dimensions	Same as standard type

Made to Order Common Specifications: -XC73: Built-in Cylinder with Lock (CDNG)



54 Built-in Cylinder with Lock (CDNG)

Symbol
-XC73

This type has a built-in cylinder with lock, which accommodates intermediate stops, emergency stops and drop prevention, etc.

Applicable Series

Series	Description	Model	Action	Note	Vol. no. (for std model)
MGG	Guide cylinder	MGG	Double acting		Web Catalog

How to Order

MGG **Bearing type** **Mounting type** **Bore size** - **Stroke** - **Auto switch** - **C** ^{Note 1} - **XC73**

Cylinder Specifications

Applicable series		MGG			
Bore size (mm)		20	25	32	40
Basic cylinder		CDNGBN Bore size - Stroke - D - Auto switch - C ^{Note 1}			
Minimum operating pressure		0.2 MPa (Horizontal with no load)			
Piston speed		50 to 1000 mm/s ^{Note 2}			
Stroke adjustment range (One side) [Built-in adjustment bolts (2 pcs.)]		0 to -15 mm			
Non-rotating accuracy ^{#2}	Slide bearing	±0.06°	±0.05°	±0.04°	
	Ball bushing bearing	±0.04°	±0.04°	±0.04°	
Shock absorber model		RB1412		RB2015	
Specifications other than above		Same as standard type			

● Built-in cylinder with lock

Note 1) This symbol is indicated when the D-A9□ or M9□ type auto switch is specified. It does not apply to other auto switches (D-C7□ and H7□, etc.) (Nil)

Note 2) When the piston is locked, the load mass is limited by the mounting orientation and the operating pressure. For details about the lock specifications, etc., refer to the cylinders with lock (Web Catalog).

* Non-rotating rod accuracy must be below the values shown in the table at the retraction of the cylinder (initial value), and without loads or the conditions excluding the deflection of the guide rods.

Dimensions

Basic type/MGG□B

ø20 to ø40

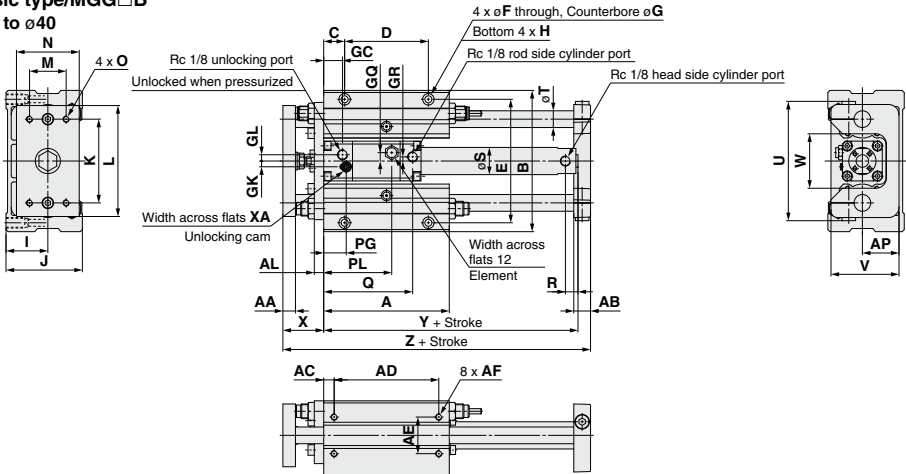

Standard Stroke

Bore size (mm)	Stroke range (mm)	A	AA	AB	AC	AD	AE	AF	AL	AP	B	C	D	E	F	G	GC	GK	GL	GQ	GR	H	I	J
20	75, 100, 125, 150, 200	120	12	16	10	100	35	M6 x 1 depth 12	9	35	135	20	80	118	6.6	11 depth 8	18	5.5	6	8	4	M10 x 1.5 depth 18	40	73
25	75, 100, 125	140	16	19	10	120	40	M8 x 1.25 depth 16	9	45	170	20	100	150	9	14 depth 10	25	6.5	9	10	7	M12 x 1.75 depth 21	50	93
32	150, 200	140	16	19	10	120	40	M8 x 1.25 depth 16	9	45	170	20	100	150	9	14 depth 10	25	6.5	9	10	7	M12 x 1.75 depth 21	50	93
40	250, 300	170	19	21	10	150	45	M10 x 1.5 depth 20	12	50	194	25	120	170	11	17 depth 12	26	7	11	12	7	M14 x 2 depth 25	55	103

Long Stroke

Bore size (mm)	K	L	M	N	O	PG	PL	Q	R	S	T	U	V	W	X	XA	Y	Z	Bore size (mm)	Stroke range (mm)	R	Y
20	80	106	35	60	M6 x 1 depth 9	21.5	65	85	12	26	16	114	65	52	39	3	143	194	20	250 to 400	14	151
25	95	134	50	75	M8 x 1.25 depth 13	26.5	73	96	12	31	20	138	84	62	46	3	153	228	25	350 to 500	14	161
32	95	134	50	75	M8 x 1.25 depth 13	26.5	73	97	12	38	20	138	84	62	46	3	156	228	32	350 to 600	14	164
40	115	152	56	90	M10 x 1.5 depth 16	28	81	104	12	47	25	164	94	75	56	4	171	274	40	350 to 800	15	180

Made to Order Common Specifications: -XC73: Built-in Cylinder with Lock (CDNG)



54 Built-in Cylinder with Lock (CDNG)

Symbol
-XC73

Dimensions

Front mounting flange type/MGG□F
ø20 to ø40

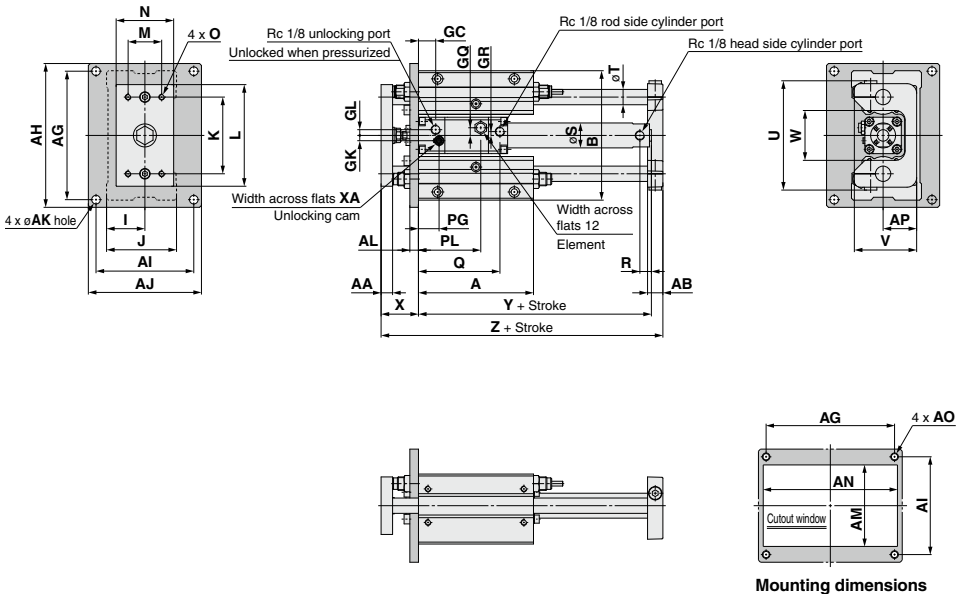

Mounting dimensions

Standard Stroke

Bore size (mm)	Stroke range (mm)	A	AA	AB	AG	AH	AI	AJ	AK	AL	AM	AN	AO	AP	B	GC	GK	GL	GQ	GR	I	J	K	L	M	N
20	75, 100, 125, 150, 200	120	12	16	134	150	102	118	9	9	85	140	M8	35	135	18	5.5	6	8	4	40	73	80	106	35	60
25	75, 100, 125	140	16	19	170	186	134	150	9	9	105	175	M8	45	170	25	6.5	9	10	7	50	93	95	134	50	75
		140	16	19	170	186	134	150	9	9	105	175	M8	45	170	25	6.5	9	10	7	50	93	95	134	50	75
40	250, 300	170	19	21	190	210	140	160	11	12	115	200	M10	50	194	26	7	11	12	7	55	103	115	152	56	90

Long Stroke

Bore size (mm)	O	PG	PL	Q	R	S	T	U	V	W	X	XA	Y	Z
20	M6 x 1 depth 9	21.5	65	85	12	26	16	114	65	52	39	3	143	194
25	M8 x 1.25 depth 13	26.5	73	96	12	31	20	138	84	62	46	3	153	228
32	M8 x 1.25 depth 13	26.5	73	97	12	38	20	138	84	62	46	3	156	228
40	M10 x 1.5 depth 16	28	81	104	12	47	25	164	94	75	56	4	171	274

Bore size (mm)	Stroke range (mm)	R	Y
20	250 to 400	14	151
25	350 to 500	14	161
32	350 to 600	14	164
40	350 to 800	15	180

Made to Order Common Specifications: -XC73: Built-in Cylinder with Lock (CDNG)



54 Built-in Cylinder with Lock (CDNG)

Symbol
-XC73

This type has a built-in cylinder with lock, which accommodates intermediate stops, emergency stops and drop prevention, etc.

How to Order

MGC **Bearing type** **Mounting type** **Bore size** - **Stroke** - **Equipped/Not equipped rear plate** - **Auto switch** - **C (Note 1)** - **XC73**

Cylinder Specifications

Applicable series		MGC			
Bore size (mm)		20	25	32	40
Basic cylinder		CDNGBA	Bore size	Stroke	D - Auto switch - C (Note 1)
Minimum operating pressure		0.2 MPa (Horizontal with no load)			
Piston speed		50 to 750 mm/s (Note 2)			
Non-rotating accuracy #2	Slide bearing	±0.06°	±0.05°	±0.04°	
	Ball bushing bearing	±0.04°	±0.04°	±0.04°	
Specifications other than above		Same as standard type			

Built-in cylinder with lock

- Note 1) This symbol is indicated when the D-A9□ or M9□ type auto switch is specified. It does not apply to other auto switches (D-C7□ and H7□, etc.) (Nil)
- Note 2) When the piston is locked, the load mass is limited by the mounting orientation and the operating pressure. For details about the lock specifications, etc., refer to the cylinders with lock (Web Catalog).
- * Non-rotating rod accuracy must be below the values shown in the table at the retraction of the cylinder (initial value), and without loads or the conditions excluding the deflection of the guide rods.

Dimensions

Basic type/MGC□B
ø20 to ø40

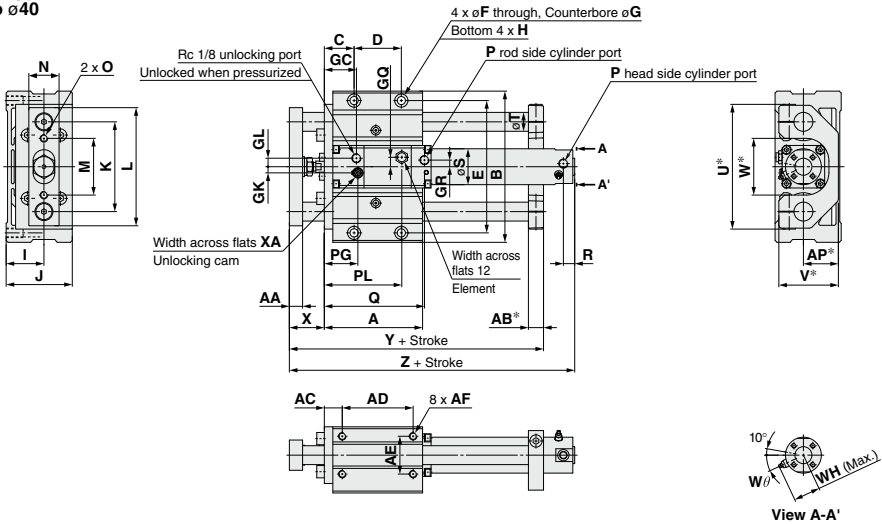

Standard Stroke

Bore size (mm)	Stroke range (mm)	A	AA	AB*	AC	AD	AE	AF	AP*	B	C	D	E	F	G	GC	GK	GL	GQ	GR	H	I	J	K
20	75, 100, 125, 150, 200	94	11	13	16.5	70	35	M6 x 1 depth 12	32	135	26.5	50	118	6.8	11 depth 8	27	5.5	6	8	4	M8 x 1.25 depth 14	35	60	80
25	75, 100, 125	104	14	16	19	75	40	M8 x 1.25 depth 16	37	160	31.5	50	140	8.6	14 depth 10	34	6.5	9	10	7	M10 x 1.5 depth 18	40	70	95
32	150, 200	104	14	16	19	75	40	M8 x 1.25 depth 16	37	160	31.5	50	140	8.6	14 depth 10	34	6.5	9	10	7	M10 x 1.5 depth 18	40	70	95
40	250, 300	142	17	19	22	110	45	M10 x 1.5 depth 20	42	194	37	80	170	10.5	17 depth 12	38	7	11	12	7	M12 x 1.75 depth 21	45	82.5	115

Long Stroke

Bore size (mm)	L	M	N	O	P	PG	PL	Q	R	S	T	U*	V*	W*	WH	W/ø	X	XA	Y	Z	Bore size (mm)	Stroke range (mm)	R	Z
20	105	50	25	M6 x 1	M5 x 0.8	30.5	74	96	12	26	16	112	53	50	23	30°	30	3	148	182	20	250 to 400	14	190
25	125	60	32	M8 x 1.25	M5 x 0.8	35.5	82	106	12	31	20	132	63	60	25	30°	37	3	169	199	25	350 to 500	14	207
32	125	60	32	M8 x 1.25	Rc 1/8	35.5	82	106	12	38	20	132	63	60	28.5	25°	37	3	169	209	32	350 to 600	14	210
40	150	75	38	M8 x 1.25	Rc 1/8	40	93	116	12	47	25	162	73	70	33	20°	44	4	210	227	40	350 to 800	15	236

Note) Without rear plate: Dimensions with an asterisk (*) mark is not needed.



Made to Order Common Specifications:

-XC73: Built-in Cylinder with Lock (CDNG)

-XC74: With Front Plate for MGG Cylinder



54 Built-in Cylinder with Lock (CDNG)

Symbol
-XC73

Dimensions

Front mounting flange type/MGC□F

ø20 to ø40

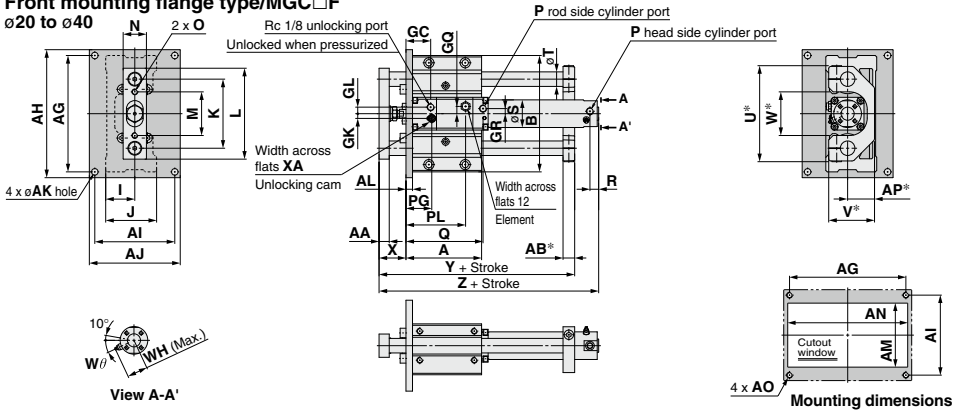

Standard Stroke

Bore size (mm)	Stroke range (mm)	A	AA	AB*	AG	AH	AI	AJ	AK	AL	AM	AN	AO	AP*	B	GC	GK	GL	GQ	GR	I	J	K	L	M	N
20	75, 100, 125, 150, 200	94	11	13	134	150	92	108	9	9	75	140	M8	32	135	27	5.5	6	8	4	35	60	80	105	50	25
25	75, 100, 125	104	14	16	160	176	110	125	9	9	88	165	M8	37	160	34	6.5	9	10	7	40	70	95	125	60	32
32	150, 200, 250, 300	104	14	16	160	176	110	125	9	9	88	165	M8	37	160	34	6.5	9	10	7	40	70	95	125	60	32
40		142	17	19	190	210	115	135	11	12	96	200	M10	42	194	38	7	11	12	7	45	82.5	115	150	75	38

Long Stroke

Bore size (mm)	O	P	PG	PL	Q	R	S	T	U*	V*	W*	WH	Wθ	X	XA	Y	Z	Bore size (mm)	Stroke range (mm)	R	Z
20	M6 x 1	M5 x 0.8	30.5	74	96	12	26	16	112	53	50	23	30°	30	3	148	182	20	250 to 400	14	190
25	M8 x 1.25	M5 x 0.8	35.5	82	106	12	31	20	132	63	60	25	30°	37	3	169	199	25	350 to 500	14	207
32	M8 x 1.25	Rc 1/8	35.5	82	106	12	38	20	132	63	60	28.5	25°	37	3	169	202	32	350 to 600	14	210
40	M8 x 1.25	Rc 1/8	40	93	116	12	47	25	162	73	70	33	20°	44	4	210	227	40	350 to 800	15	236

(Note) Without rear plate: Dimensions with an asterisk (*) mark is not needed.

55 With Front Plate for MGG Cylinder

Symbol
-XC74

This type uses a front plate equivalent to the MGG series.

How to Order

MGC -XC74

With front plate for MGG

Specifications

Applicable series	MGC
Bore size (mm)	20, 25, 32, 40, 50
Fluid	Air
Minimum operating pressure	0.15 MPa (Horizontal, With no load)
Piston speed	50 to 750mm/s
Auto switch	Mountable

* Specifications other than above are the same as standard type.

Dimensions (Dimensions other than below are the same as standard type.)

ø20 to ø50

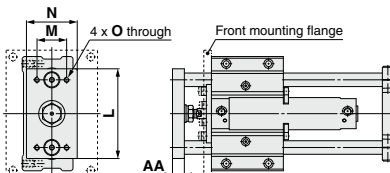

Bore size (mm)	L	M	N	O	AA
20	80	25	45	M6 x 1	11
25	100	35	54	M6 x 1	14
32	106	35	60	M6 x 1	14
40	134	50	75	M8 x 1.25	17
50	152	56	90	M10 x 1.5	23

Made to Order Common Specifications: -XC78: Auto Switch Mounting Special Dimensions at Stroke End



56 Auto Switch Mounting Special Dimensions at Stroke End

Symbol
-XC78

Auto switch mounting position at stroke end is assembled like below.

Applicable Series

Series	Description	Model	Action	Note	Vol. no. (for std model)
MGC	Guide cylinder	MGC	Double acting		Web Catalog

How to Order

MGC Standard model no. **-XC78**

Auto switch mounting special dimensions at stroke end

Specifications

Applicable series	MGC
Bore size (mm)	20, 25, 32, 40, 50
Applicable cylinder	Guide cylinder
Specifications other than above	Same as standard type

Dimensions (Dimensions other than below are the same as standard type.)

D-M9□(V)/M9□(V)/M9□A(V)
D-A9□(V)

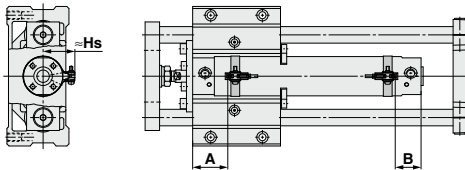

D-B5/B6
D-G5/K5

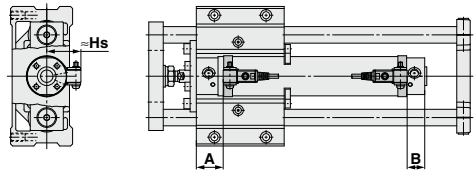

D-C7/C8
D-H7

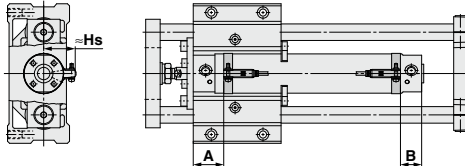

D-B7/B8
D-G7/K7

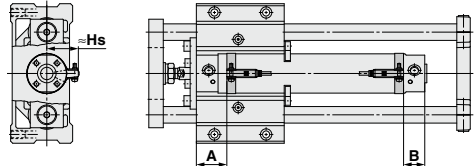

Proper Auto Switch Mounting Position

Auto switch model	(mm)															
	D-M9□(V) D-M9□W(V) D-M9□A(V)		D-A9□(V)		D-B7/B8 D-B73C D-B80C D-G7/K7 D-K79C		D-C7□ D-C80 D-C73C D-C80C		D-B5□ D-B64		D-B59W		D-H7□ D-H7C D-H7NF D-H7□W D-H7BA		D-G59□G5 D-K59 D-G5W D-K59W D-G5NT D-G5BA	
	A	B	A	B	A	B	A	B	A	B	A	B	A	B	A	B
20	33	24 (32)	29	20 (28)	30.5	21.5 (29.5)	29.5	20.5 (28.5)	23.5	15.5 (22.5)	26.5	17.5 (25.5)	28.5	19.5 (27.5)	25	16 (24)
25	33	24 (32)	29	20 (28)	30.5	21.5 (29.5)	29.5	20.5 (28.5)	23.5	15.5 (22.5)	26.5	17.5 (25.5)	28.5	19.5 (27.5)	25	16 (24)
32	34	25 (33)	30	21 (29)	31.5	22.5 (30.5)	30.5	21.5 (29.5)	24.5	15.5 (23.5)	27.5	18.5 (26.5)	29.5	20.5 (28.5)	26	17 (25)
40	39	27 (36)	35	23 (32)	36.5	24.5 (33.5)	35.5	23.5 (32.5)	29.5	19 (26.5)	32	20.5 (29.5)	34.5	22.5 (31.5)	31	19 (28)
50	46	32 (36)	42	28 (40)	43.5	29.5 (41.5)	42.5	28.5 (40.5)	36.5	22.5 (34.5)	39.5	25.5 (37.5)	41.5	27.5 (39.5)	38	24 (36)

Proper Auto Switch Mounting Height

Auto switch model	(mm)					
	D-M9□(V) D-M9□W(V) D-A9□(V)		D-C7□/C80 D-H7□ D-H7NF D-H7BA	D-C73C D-C80C	D-B7□/B80 D-B73C D-B80C D-G79/K79 D-H7C D-G5NT D-G5BA	D-G5□/K59 D-G5W D-K59W D-G5BA D-G59F
	Hs	Hs	Hs	Hs		
20	25	24.5	27	27.5		
25	27.5	27	29.5	30		
32	31	30.5	33	33.5		
40	35.5	35	37.5	38		
50	41	40.5	43	43.5		

* () : Long stroke, double rod

Note) Adjust the auto switch after confirming the operating conditions in the actual setting.

Made to Order Common Specifications: -XC82: Bottom Mounting Type



57 Bottom Mounting Type

Symbol
-XC82

Since the guide rod does not protrude from the bottom at the retraction of the rod, relief holes for guide rods are not required.

Applicable Series

Series	Description	Model	Action	Note	Vol. no. (for std model)
MGP	Compact guide cylinder	MGPM	Double acting		Web Catalog

How to Order

MGP M 32 - 50 Z - -XC82

- Compact guide cylinder
- Bearing Type
 - M Slide bearing
- Bore size (mm)

12	12 mm
16	16 mm
20	20 mm
25	25 mm
32	32 mm
40	40 mm
50	50 mm
63	63 mm
80	80 mm
100	100 mm
- Port thread type
- Cylinder stroke (mm)

Bore size (mm)	Applicable stroke (mm)
12 to 25	75, 100
32 to 100	25, 50, 75, 100
- Auto switch
- Suffix for auto switch
- Bottom mounting type

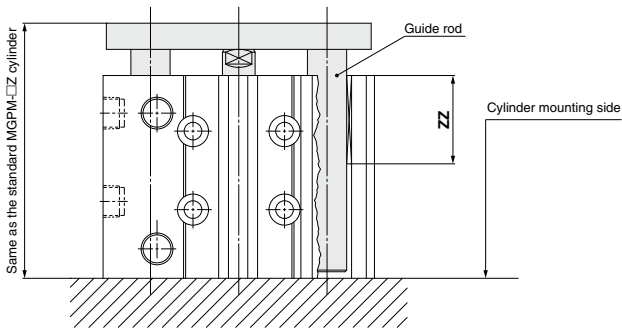

(Note) The total length (ZZ) of the guide rod bushing is shorter than the standard type.

Made to Order Common Specifications: -XC83: Built-in Cylinder with Lock (MDNB)



58 Built-in Cylinder with Lock (MDNB)

Symbol
-XC83

This type has a built-in cylinder with lock, which accommodates intermediate stops, emergency stops and drop prevention, etc.

Applicable Series

Series	Description	Model	Action	Note	Vol. no. (for std model)
MGG	Guide cylinder	MGG	Double acting		Web Catalog

How to Order

MGG **Bearing type** **Mounting type** **Bore size** — **Stroke** — **Auto switch** — **XC83**

Specifications

Applicable series		MGG			
Bore size (mm)		50	63	80	100
Basic cylinder		MDNBB	Bore size	Stroke	-D- Auto switch -X1189
Minimum operating pressure		0.2 MPa (Horizontal with no load)			
Piston speed <small>Note</small>		50 to 1000 mm/s		50 to 700 mm/s	
Stroke adjustment range (One side) [Built-in adjusting bolts (2 pcs.)]		0 to -15 mm			
Non-rotating accuracy *	Slide bearing	±0.04°		±0.03°	
	Ball bushing bearing	±0.03°		±0.02°	
Shock absorber model		RB2015		RB2725	
Specifications other than above		Same as standard type			

● Built-in cylinder with lock

Note) When the piston is locked, the load mass is limited by the mounting orientation and the operating pressure. For details about the lock specifications, etc., refer to the cylinders with lock (**Web Catalog**).

* Non-rotating rod accuracy must be below the values shown in the table at the retraction of the cylinder (initial value), and without loads or the conditions excluding the deflection of the guide rods.

Applicable Auto Switches Refer to pages 1289 to 1383 for the detailed specifications of auto switches.

Type	Special function	Electrical entry	Indicator light	Wiring (output)	Load voltage		Auto switch part no.	Band mounting	Lead wire length (m)				Pre-wired connector	Applicable load			
					DC	AC			0.5 (Nil)	1 (M)	3 (L)	5 (Z)					
Solid state auto switch	—	Grommet	No	3-wire (NPN)	5 V, 12 V	—	M9N	—	●	●	●	○	○	IC circuit			
				3-wire (PNP)			M9P	—	●	●	●	○	○				
		Terminal conduit		2-wire	12 V	M9B	—	●	●	●	○	○	—				
				3-wire (NPN)		—	G39	—	—	—	—	—					
	Diagnostic indication (2-color)	Grommet	Yes	3-wire (NPN)	5 V, 12 V	—	M9NW	—	●	●	●	○	○	IC circuit			
				3-wire (PNP)			M9PW	—	●	●	●	○	○				
				2-wire	M9BW		—	●	●	●	○	○	—				
				3-wire (NPN)	M9NA		—	○	○	●	○	○					
				Water resistant (2-color indicator)	3-wire (PNP)		M9PA	—	○	○	●	○	○	IC circuit			
					2-wire		M9BA	—	○	○	○	○	○				
Reed auto switch	—	Grommet	Yes	3-wire (NPN equivalent)	—	5 V	A96	—	●	—	●	—	IC circuit	—			
				No			2-wire	24 V	12 V	100 V	A93	—			●	●	●
		Terminal conduit		Yes	2-wire	24 V	12 V	100 V or less	A90	—	●	—	●	—	IC circuit	Relay, PLC	
								—	A33	—	—	—	—	—			—
								100 V, 200 V	A34	—	—	—	—	—			—

* Lead wire length symbols: 0.5 m Nil (Example) M9NW 1 m M (Example) M9NWM 3 m L (Example) M9NWL 5 m Z (Example) M9NWX

* Solid state auto switch with ○: Manufactured upon receipt of order.

* Refer to page 1566 since there are applicable auto switches other than listed above.
* Refer to pages 1358 and 1359 for the details of auto switches with a pre-wired connector.
* D-A9□/M9□/M9□W/M9□A/M9□AV auto switches are shipped together (not assembled).
(Auto switch mounting brackets for the models above are mounted when shipped.)

Auto Switch Mounting Bracket: Part No.

Auto switch model	Bore size (mm)			
	ø50	ø63	ø80	ø100
D-A9□/A9□V D-M9□/M9□V D-M9□W/M9□WV D-M9□A/M9□AV	BA7-040	BA7-040	BA7-063	BA7-063
D-A3□/A44 D-G39/K39	BMB1-050	BMB1-063	BMB1-080	BMB1-100
D-Z7□/Z80 D-Y59□/Y69□ D-Y7P/Y7PV D-Y7□W/Y7□WV D-Y7BA	BMB4-050	BMB4-050	BA4-063	BA4-063

[Mounting screw set made of stainless steel]

The following set of mounting screws made of stainless steel (including nuts) is available. Use it in accordance with the operating environment. (Please order the auto switch mounting bracket separately, since it is not included.)

BBA1: Stainless steel screw set for D-A5/A6/F5/J5 types

Note) Refer to page 1395 for the details of BBA1.

When shipping cylinders with D-M9□A/M9□AV/Y7BA auto switches, the stainless steel screws above are used to secure auto switch mounting brackets.

Made to Order Common Specifications: -XC83: Built-in Cylinder with Lock (MDNB)



58 Built-in Cylinder with Lock (MDNB)

Symbol
-XC83

Besides the models listed on the previous page, the following auto switches are applicable. Refer to pages 1289 and 1383 for details.

Auto switch type	Part no.	Electrical entry (Felching direction)	Features
Reed	D-A93V, A96V	Grommet (Perpendicular)	—
	D-A90V		Without indicator light
	D-Z73, Z76	Grommet (In-line)	—
	D-Z80		Without indicator light
Solid state	D-M9NV, M9PV, M9BV	Grommet (Perpendicular)	—
	D-Y69A, Y69B, Y7PV		—
	D-M9NWV, M9PWV, M9BWW		Diagnostic indication (2-color)
	D-Y7NWV, Y7PWV, Y7BWW		Water resistant (2-color indicator)
	D-M9NAV, M9PAV, M9BAV	Grommet (In-line)	—
	D-Y59A, Y59B, Y7P		—
	D-Y7NW, Y7PW, Y7BW		Diagnostic indication (2-color)
	D-Y7BA		Water resistant (2-color indicator)

* For solid state switches, auto switches with a pre-wired connector are also available. Refer to pages 1358 and 1359 for details.
* Normally closed (NC = b contact) solid state auto switches (D-F9G/F9H/Y7G/Y7H types) are also available. Refer to pages 1308 and 1310 for details.

Refer to the MNB series in the **Web Catalog** for the minimum auto switch mounting stroke, proper auto switch mounting position and operating range.

Dimensions

Basic type ø50 to ø100

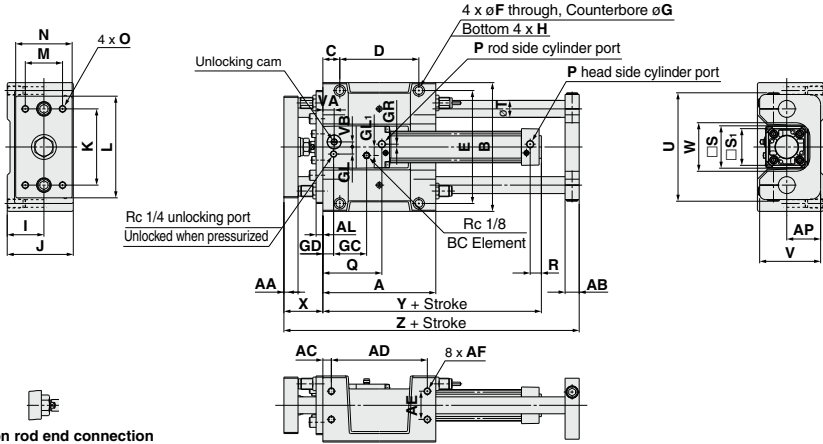

Standard Stroke

Bore size (mm)	Stroke range (mm)	A	AA	AB	AC	AD	AE	AF	AL	AP	B	C	D	E	F	G	GC	GD	GL	GL ₁	GR	H	I
50	75, 100, 125	200	25	25	15	170	50	M12 x 1.75 depth 24	12	60	228	30	140	200	13.5	23 depth 14.5	58.5	19	12.5	15	5	M16 x 2 depth 28	65
63	150, 200	230	25	27	15	200	55	M12 x 1.75 depth 24	12	70	262	30	170	234	13.5	23 depth 14.5	68	23	17.5	12	9	M16 x 2 depth 28	75
80	250, 300	280	30	30	17.5	245	70	M14 x 2 depth 28	16	80	304	35	210	274	15	23 depth 17	81	33	22	18	11.5	M18 x 2.5 depth 32	85
100		280	32	30	17.5	245	70	M14 x 2 depth 28	16	80	304	35	210	274	15	23 depth 17	96	37.5	25	20	17	M18 x 2.5 depth 32	85

Bore size (mm)	J	K	L	M	N	O	P	Q	R	S	S ₁	T	U	V	VA	VB	W	X	Y	Z
50	117	135	180	66	100	M12 x 1.75 depth 23	Rc 1/4	104.5	19.5	75	65	30	192	108	20	9	86	69	187	323
63	138	160	214	76	115	M12 x 1.75 depth 23	Rc 3/8	119.5	20.5	90	75	35	224	128	23	8.5	104	69	201	358
80	153	190	245	80	125	M14 x 2 depth 28	Rc 3/8	150	23	102	95	40	262	143	33	10.5	128	87	249	431
100	153	190	245	80	125	M14 x 2 depth 30	Rc 1/2	170	23	116	114	40	262	143	37.5	10.5	128	87	269	431

Long Stroke

Bore size (mm)	Stroke range (mm)
50	350 to 1000
63	350 to 1000
80	350 to 1000
100	350 to 1000

Made to Order Common Specifications: -XC83: Built-in Cylinder with Lock (MDNB)



58 Built-in Cylinder with Lock (MDNB)

Symbol
-XC83

Dimensions

Front mounting flange type
ø50 to ø100

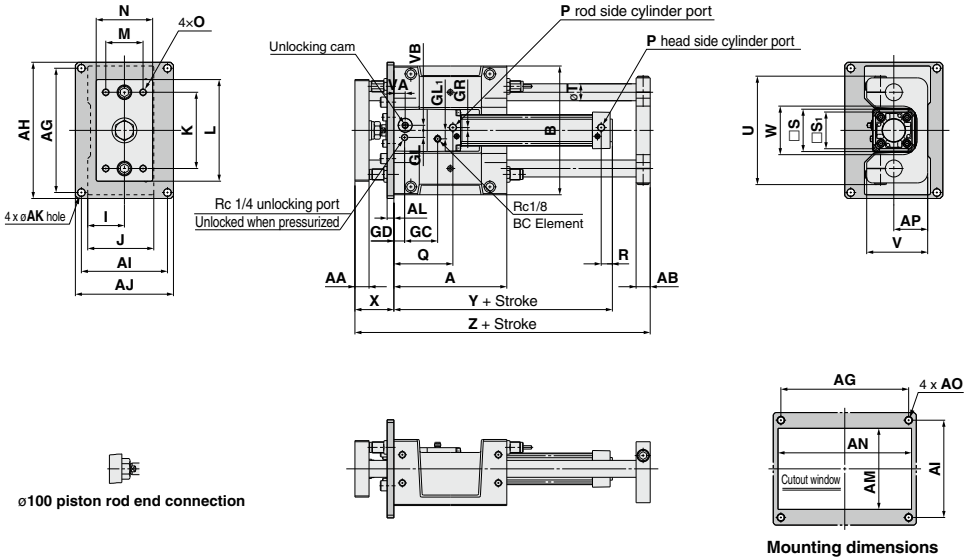

Standard Stroke

Bore size (mm)	Stroke range (mm)	A	AA	AB	AG	AH	AI	AJ	AK	AL	AM	AN	AO	AP	B	GC	GD	GL	GL ₁	GR	I	J	K	L	M	N
50	75, 100, 125	200	25	25	228	250	158	180	14	12	135	234	M12	60	228	58.5	19	12.5	15	5	65	117	135	180	66	100
	150, 200	230	25	27	262	284	178	200	14	12	155	268	M12	70	262	68	23	17.5	12	9	75	138	160	214	76	115
63	250, 300	280	30	30	300	326	200	226	16	16	175	310	M14	80	304	81	33	22	18	11.5	85	153	190	245	80	125
		280	32	30	300	326	200	226	16	16	175	310	M14	80	304	96	37.5	25	20	17	85	153	190	245	80	125

Bore size (mm)	O	P	Q	R	S	S ₁	T	U	V	VA	VB	W	X	Y	Z
50	M12 x 1.75 depth 23	Rc 1/4	104.5	19.5	75	65	30	192	108	20	9	86	69	187	323
63	M12 x 1.75 depth 23	Rc 3/8	119.5	20.5	90	75	35	224	128	23	8.5	104	69	201	358
80	M14 x 2 depth 28	Rc 3/8	150	23	102	95	40	262	143	33	10.5	128	87	249	431
100	M14 x 2 depth 30	Rc 1/2	170	23	116	114	40	262	143	37.5	10.5	128	87	269	431

Long Stroke

Bore size (mm)	Stroke range (mm)
50	350 to 1000
63	350 to 1000
80	350 to 1000
100	350 to 1000

Made to Order Common Specifications: -XC85: Grease for Food Processing Equipment



59 Grease for Food Processing Equipment

Symbol
-XC85

Food grade grease (certified by NSF-H1) is used as lubricant.

Applicable Series

Series	Description	Model	Action	Note	Vol. no. (for std model)
CJ2	Air cylinder	CJ2-Z	Double acting, Single rod Single acting Spring returnless		
		CJ2W-Z	Double acting, Double rod		
	Non-rotating rod type	CJ2K-Z	Double acting, Single rod Single acting Spring returnless		
		CJ2Z-Z	Double acting, Single rod		
	With speed controller	CJ2ZW-Z	Double acting, Double rod		
	Direct mount type	CJ2RA-Z	Double acting, Single rod Single acting Spring returnless		
CJ2RK-Z		Double acting, Single rod Single acting Spring returnless			
CM2	Air cylinder	CM2-Z1	Double acting, Single rod		Web Catalog
		CM2-Z	Double acting, Single rod		
		CM2W-Z	Double acting, Double rod		
		CM2-Z	Double acting, Single rod Single acting Spring returnless		
	Non-rotating rod type	CM2K-Z	Double acting, Single rod		
		CM2KW-Z	Double acting, Double rod		
	Direct mount type	CM2K-Z	Double acting, Single rod Single acting Spring returnless		
		CM2R-Z	Double acting, Single rod		
CG1	Air cylinder	CM2RP	Double acting, Single rod	Except with rod boot	
		CG1-Z1	Double acting, Single rod		
		CG1-Z	Double acting, Single rod		
		CG1W-Z	Double acting, Double rod		
Direct mount type	CG1-Z	Double acting, Single rod Single acting Spring returnless			
	CG1R-Z	Double acting, Single rod			
CA2	Air cylinder	CA2-Z	Double acting, Single rod		
		CA2W-Z	Double acting, Double rod		

Series	Description	Model	Action	Note	Vol. no. (for std model)
CGS	Compact cylinder	CQS	Double acting, Single rod		
		CQS	Single acting, Single rod		
		CQSW	Double acting, Double rod		
	Long stroke	CQS	Double acting, Single rod		
Anti-lateral load	CQS□S	Double acting, Single rod			
CQ2	Compact cylinder	CQ2-Z	Double acting, Single rod		Web Catalog
		CQ2-Z	Single acting Spring returnless		
		CQ2W-Z	Double acting, Double rod		
	Large bore size	CQ2-Z	Double acting, Single rod		
		CQ2W-Z	Double acting, Double rod		
	Long stroke	CQ2-Z	Double acting, Single rod		
	Non-rotating rod type	CQ2K-Z	Double acting, Single rod		
		CQ2KW-Z	Double acting, Double rod		
	Water resistant	CQ2-R/V	Double acting, Single rod		
		CQ2W-R/V	Double acting, Double rod		
MGP	Axial piping type	CQP2	Double acting, Single rod		
	(Centralized piping type)	CQP2	Single acting Spring returnless		
	Anti-lateral load	CQ2□S-Z	Double acting, Double rod		
	With end lock	CBO2	Double acting, Single rod		
	Compact guide cylinder	MGP-Z	Double acting, Single rod		
	With air cushion	MGP□IAZ	Double acting, Single rod		
	With end lock	MGP	Double acting, Single rod		
	Heavy duty guide rod type	MGPS	Double acting, Single rod		
	CXSJ	Dual rod cylinder	CXSJ	Double acting	
			CXS	Double acting	

How to Order

Standard model no.

-XC85

Grease for food processing equipment

Specifications

Seal material	Nitrile rubber
Grease	Grease for food
Auto switch	Mountable
Dimensions	Same as standard model
Specifications other than above	Same as standard model

Warning Precautions

Be aware that smoking cigarettes, etc. after your hands have come into contact with the grease used in this cylinder can create a gas that is hazardous to humans.

<Not installable>

Food zone.....An environment where food which will be sold as merchandize, directly touches the cylinder's components.

Splash zone.....An environment where food which will not be sold as merchandize, directly touches the cylinder's components.

<Installable>

Non-food zone.....An environment where there is no contact with food.

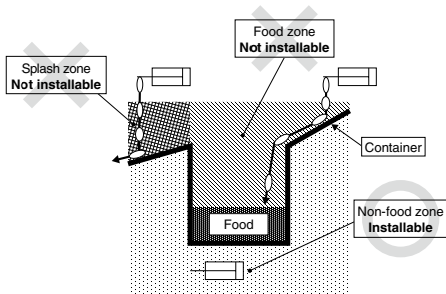

- Note 1) Avoid using this product in the food zone. (Refer to the figure above.)
 Note 2) When the product is used in an area of liquid splash, or a water resistant function is required for the product, please consult SMC.
 Note 3) Operate without lubrication from a pneumatic system lubricator.
 Note 4) Use the following grease pack for the maintenance work.
 GR-H-010 (Grease: 10 g)
 Note 5) Please contact SMC for details on the maintenance intervals for this cylinder, which differ from those of the standard cylinder.

Made to Order Common Specifications: -XC86: With Rod End Bracket



60 With Rod End Bracket

Symbol
-XC86

With rod end bracket type to simplify the order process.

Applicable Series

Series	Description	Model	Action	Note	Vol. no. (for std model)
CS1	Standard type	CS1	Double acting, Single rod		Web Catalog
	Low friction type	CS1Q	Double acting, Single rod	ø125 to ø160 only	
CS2	Standard type	CS2	Double acting, Single rod		
	Smooth cylinder	CS2Y	Double acting, Single rod	ø125 to ø160 only	

How to Order

Standard model no. —XC86 A

With rod end bracket ↓

↓ Suffix

A	With rod end nut
B	With double knuckle joint
C	With single knuckle joint
D	With double knuckle joint and rod end nut
E	With single knuckle joint and rod end nut
F	With rod end nut (For knuckle joint)

Note 1) Rod end brackets are shipped together.

Note 2) A pin and two split pins are attached for double knuckle joint.

Note 3) XC86A to C: Standard type, XC86D to F: Standard type except for rod end thread length (A and H dimensions)

Dimensions (Dimensions other than below are the same as standard type.)

CS1, CS2 series XC86B, XC86C

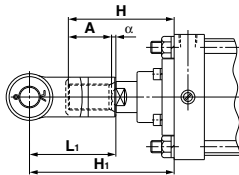

Symbol Bore size (mm)	H	A	α	L ₁	H ₁	CS1		CS2	
						Applicable knuckle joint part no.			
						I type single knuckle	Y type double knuckle	I type single knuckle	Y type double knuckle
125	110	50	3.5	100	156.5	I-12	Y-12	I-12A	Y-12A
140	110	50	3.5	105	161.5	I-14	Y-14	I-14A	Y-14A
160	120	56	3.5	110	170.5	I-16	Y-16	I-16A	Y-16A
180, 200	135	63	3.5	125	193.5	I-18, I-20	Y-18, Y-20	I-18A, I-20A	Y-18A, Y-20A
250	160	71	3.5	160	245.5	I-25	Y-25	I-25A	Y-25A
300	175	80	3.5	175	266.5	I-30	Y-30	—	—
320	175	80	3.5	175	266.5	—	—	I-32A	Y-32A

CS1, CS2 series XC86D, XC86E

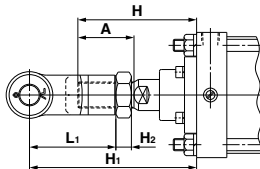

XC86F

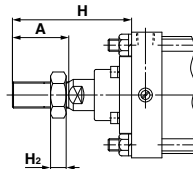

Symbol Bore size (mm)	H	A	L ₁	H ₁	H ₂	CS1		CS2		CS1, CS2 common
						Applicable knuckle joint part no.				Applicable rod end nut
						I type single knuckle	Y type double knuckle	I type single knuckle	Y type double knuckle	
125	125	65	100	181	18	I-12	Y-12	I-12A	Y-12A	NT-12
140	125	65	105	186	18	I-14	Y-14	I-14A	Y-14A	NT-12
160	140	76	110	198	21	I-16	Y-16	I-16A	Y-16A	NT-16
180	155	83	125	223	23	I-18	Y-18	I-18A	Y-18A	NT-18
200	160	88	125	227	27	I-20	Y-20	I-20A	Y-20A	NT-20
250	195	106	160	287	34	I-25	Y-25	I-25A	Y-25A	NT-25
300	210	115	175	312	38	I-30	Y-30	—	—	NT-30
320	210	115	175	312	38	—	—	I-32A	Y-32A	NT-30

Made to Order Common Specifications:

-XC86: With Rod End Bracket

-XC87: Cylinder with One-way Lock/Heavy Duty Specifications



60 With Rod End Bracket

Symbol
-XC86

Dimensions (Dimensions other than below are the same as standard type.)

CS2 series
XC86B, XC86C

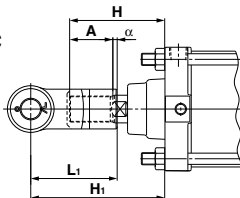

CS2 series
XC86D, XC86E

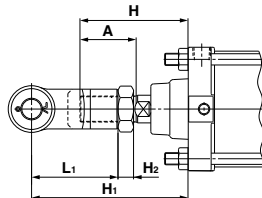

Bore size (mm)	Symbol	H	A	α	L ₁	H ₁	Applicable knuckle joint part no.	
							I type single knuckle	Y type double knuckle
125	110	50	3.5	100	156.5		I-12A	Y-12A
140	110	50	3.5	105	161.5		I-14A	Y-14A
160	120	56	3.5	110	170.5		I-16A	Y-16A

Bore size (mm)	Symbol	H	A	L ₁	H ₁	H ₂	Applicable knuckle joint part no.		Applicable rod end nut
							I type single knuckle	Y type double knuckle	
125	125	65	100	181	18		I-12A	Y-12A	NT-12
140	125	65	105	186	18		I-14A	Y-14A	NT-12
160	140	76	110	198	21		I-16A	Y-16A	NT-16

61 Cylinder with One-way Lock/Heavy Duty Specifications

Symbol
-XC87

Piston rods are heat treated. Even when an external force exceeding the specification range acts temporarily on the piston rod in the locked state, it is resistant to damage and an unlocking failure is unlikely to occur.

Applicable Series

Series	Description	Model	Action	Note	Vol. no. (for std model)
CLQ	Compact cylinder with lock	CLQ	Double acting, Single rod	Applicable to ø40 to ø100.	Web Catalog
RLQ	Compact cylinder with air cushion and lock	RLQ	Double acting, Single rod	Applicable to ø40 to ø63.	
MLGP	Compact guide cylinder with lock	MLGP	Double acting	Applicable to ø40 to ø100.	
CLK2	Clamp cylinder with lock	CLK2	Double acting, Single rod	Applicable to ø40 to ø63.	
MLU	Plate cylinder with lock	MLU	Double acting, Single rod	Applicable to ø40 and ø50.	

How to Order

Standard model no. — **XC87**
Heavy duty specifications ↓

Specifications: Same as standard type
Dimensions: Same as the standard type

Made to Order Common Specifications:

-XC88: Spatter Resistant Coil Scraper, Lube-retainer, Grease for Welding (Piston rod: Stainless steel 304)

-XC89: Spatter Resistant Coil Scraper, Lube-retainer, Grease for Welding (Piston rod: S45C)

-XC91: Spatter Resistant Coil Scraper, Grease for Welding (Piston rod: S45C)



62 Spatter Resistant Coil Scraper, Lube-retainer, Grease for Welding (Piston rod: Stainless steel 304) **-XC88** Symbol

63 Spatter Resistant Coil Scraper, Lube-retainer, Grease for Welding (Piston rod: S45C) **-XC89**

Reduces spatter adhesion and improves durability by the use of the coil scraper, Lube-retainer and grease for welding.

64 Spatter Resistant Coil Scraper, Grease for Welding (Piston rod: S45C) **-XC91**

With coil scraper and grease for welding

Applicable Series

Series	Description	Model	Action	XC88	XC89	XC91	Note	Vol. no. (for std model)
MB	Air cylinder	MB-Z	Double acting, Single rod	●	●	●	ø32-ø100 only	Web Catalog
CA2	Air cylinder	CA2-Z	Double acting, Single rod	●	●	●		
CQ2	Compact cylinder	CQ2-Z	Double acting, Single rod	●	●	●		
	Long stroke	CQ2-Z	Double acting, Single rod	●	●	—		
	Anti-lateral load	CQ2□S-Z	Double acting, Single rod	●	●	—		
MGP	Compact guide cylinder	MGPM-Z	Double acting	●	—*	●	ø32-ø100 only	
		MGPL-Z	Double acting	—	—	●		
		MGPA-Z	Double acting	—	—	●		
MK2T	Rotary clamp cylinder	MK2T	Double acting	—	●	●	ø32-ø63 only	
CKG1	Clamp cylinder	CKG1-Z1	Double acting, Single rod	●	●	●		
		CKG1-Z	Double acting, Single rod	●	●	●		
		CKGA	Double acting, Single rod	●	●	●	ø80 and ø100 only	

Common Specifications: MB, CA2, CQ2, MK2T, CKG1

Part no.	Piston rod material (Hard chrome plating)		Coil scraper	Lube-retainer	Grease for welding
	S45C	Stainless steel 304			
-XC88	—	●	●	●	●
-XC89	●	—	●	●	●
-XC91	●	—	●	—	●

Note) Use the -XC91 in a place where the distance from the welding portion is far and the spatter scattering is minimized.

Specifications: MGP

Part no.	Piston rod/Guide rod material (Hard chrome plating)		Coil scraper		Lube-retainer		Grease for welding
	S45C	Stainless steel 304	Rod side	Head side	Rod side	Head side	
-XC88	—	●	●	—	●	—	●
-XC91	●	—	●	—	●	—	●
-XC88W	—	●	●	●	●	●	●
-XC89W	●	—	●	●	●	●	●
-XC91W	●	—	●	●	●	—	●

* There is no "-XC89" part number suffix as the specifications are the same as those of the "-XC91."

Made to Order Common Specifications:

- XC88: Spatter Resistant Coil Scraper, Lube-retainer, Grease for Welding (Piston rod: Stainless steel 304)
- XC89: Spatter Resistant Coil Scraper, Lube-retainer, Grease for Welding (Piston rod: S45C)
- XC91: Spatter Resistant Coil Scraper, Grease for Welding (Piston rod: S45C)



MB-XC88/XC89/XC91

62 Spatter Resistant Coil Scraper, Lube-retainer, Grease for Welding (Piston rod: Stainless steel 304) **-XC88**

63 Spatter Resistant Coil Scraper, Lube-retainer, Grease for Welding (Piston rod: S45C) **-XC89**

Reduces spatter adhesion and improves durability by the use of the coil scraper, Lube-retainer and grease for welding.

64 Spatter Resistant Coil Scraper, Grease for Welding (Piston rod: S45C) **-XC91**

With coil scraper and grease for welding

Applicable Series

Series	Description	Model	Action	XC88	XC89	XC91	Vol. no. (for std. model)
MB	Air cylinder	MB-Z	Double acting, Single rod	●	●	●	Web Catalog

How to Order

Standard model no. — XC89

Spatter-resistant rod material

XC88	Stainless steel 304
XC89	S45C
XC91	S45C

Made to Order

Part no.	Piston rod material (Hard chrome plated)		Coil scraper	Lube-retainer	Grease for welding
	S45C	Stainless steel 304			
-XC88	—	●	●	●	●
-XC89	●	—	●	●	●
-XC91	●	—	●	—	●

Note) Use the -XC91 in a place where the distance from the welding portion is far and the spatter scattering is minimized.

Specifications

Bore size	ø32, ø40, ø50, ø63, ø80, ø100
Port thread type	Rc
Max. manufacturable stroke	See right side.
Rod boot	None
Cushion	Air cushion
Dimensions	See below.
Additional specifications	Same as standard type

Max. manufacturable stroke

Bore size (mm)	Max. manufacturable stroke
32	1000
40	1000
50	1000
63	1000
80	1000
100	1000

Manufacture of intermediate strokes is possible. (Spacers are not used.)
Produced upon receipt of order.

Dimensions (Other dimensions are the same as the standard type.)

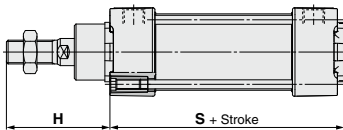

Bore size (mm)	XC88, 89		XC91		XC35	
	H	S	H	S	H	S
32	50	88	47	88	47	88
40	61	88	58	88	58	88
50	67	98	67	98	67	98
63	67	98	67	98	67	98
80	82	118	81	118	81	118
100	82	118	81	118	81	118

* At 0 stroke

Made to Order Common Specifications:

- XC88: Spatter Resistant Coil Scraper, Lube-retainer, Grease for Welding (Piston rod: Stainless steel 304)
- XC89: Spatter Resistant Coil Scraper, Lube-retainer, Grease for Welding (Piston rod: S45C)
- XC91: Spatter Resistant Coil Scraper, Grease for Welding (Piston rod: S45C)



CA2-XC88/XC89/XC91

62 Spatter Resistant Coil Scraper, Lube-retainer, Grease for Welding (Piston rod: Stainless steel 304) **-XC88**

63 Spatter Resistant Coil Scraper, Lube-retainer, Grease for Welding (Piston rod: S45C) **-XC89**

Reduces spatter adhesion and improves durability by the use of the coil scraper, Lube-retainer and grease for welding.

64 Spatter Resistant Coil Scraper, Grease for Welding (Piston rod: S45C) **-XC91**

With coil scraper and grease for welding

Applicable Series

Series	Description	Model	Action	XC88	XC89	XC91	Vol. no. (for std model)
CA2	Air cylinder	CA2-Z	Double acting, Single rod	●	●	●	Web Catalog

How to Order

Standard model no. — XC89

Spatter-resistant rod material

XC88	Stainless steel 304
XC89	S45C
XC91	S45C

Made to Order

Part no.	Piston rod material (Hard chrome plated)		Coil scraper	Lube-retainer	Grease for welding
	S45C	Stainless steel 304			
-XC88	—	●	●	●	●
-XC89	●	—	●	●	●
-XC91	●	—	●	—	●

Note) Use the -XC91 in a place where the distance from the welding portion is far and the spatter scattering is minimized.

Specifications

Bore size	ø40, ø50, ø63, ø80, ø100
Tubing material	Aluminum tube
Port thread type	Rc
Max. manufacturable stroke	See right side.
Rod boot	None
Cushion	Air cushion
Dimensions	See below.
Additional specifications	Same as standard type

Max. manufacturable stroke

(mm)

Bore size	Max. manufacturable stroke ^{Note 1)}
40	1000
50, 63	1000
80, 100	1000

Note 1) For details about applicable maximum stroke, refer to the model selection table on the Web Catalog.

Dimensions (Other dimensions are the same as the standard type.)

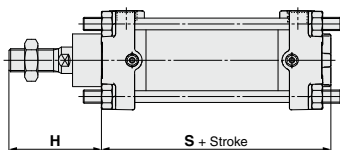

Bore size (mm)	XC88, 89		XC91		XC35	
	H	S	H	S	H	S
40	56	95	51	95	51	95
50	60	101	58	101	58	101
63	60	112	58	112	58	112
80	73	133	71	133	71	133
100	74	143	72	143	72	143

* At 0 stroke

Made to Order Common Specifications:

-XC88: Spatter Resistant Coil Scraper, Lube-retainer, Grease for Welding (Piston rod: Stainless steel 304)

-XC89: Spatter Resistant Coil Scraper, Lube-retainer, Grease for Welding (Piston rod: S45C)

-XC91: Spatter Resistant Coil Scraper, Grease for Welding (Piston rod: S45C)



CQ2-XC88/XC89/XC91

62 Spatter Resistant Coil Scraper, Lube-retainer, Grease for Welding (Piston rod: Stainless steel 304) **-XC88**

63 Spatter Resistant Coil Scraper, Lube-retainer, Grease for Welding (Piston rod: S45C) **-XC89**

Reduces spatter adhesion and improves durability by the use of the coil scraper, Lube-retainer and grease for welding.

64 Spatter Resistant Coil Scraper, Grease for Welding (Piston rod: S45C) **-XC91**

With coil scraper and grease for welding

■ CDQ2 series (Standard)

■ CDQ2 series (Long Stroke)

■ CDQ2□S series (Anti-lateral Load)

Applicable Series

Series	Description	Model	Action	Note	XC88	XC89	XC91
CQ2	Compact cylinder	CQ2-Z	Double acting, Single rod	With auto switch magnet only	●	●	●
	Long stroke	CQ2-Z	Double acting, Single rod		●	●	—
	Anti-lateral load	CQ2□S-Z	Double acting, Single rod		●	●	—

Made to Order

Part no.	Piston rod material (Hard chrome plated)		Coil scraper	Lube-retainer	Grease for welding
	S45C	Stainless steel 304			
-XC88	—	●	●	●	●
-XC89	●	—	●	●	●
-XC91	●	—	●	—	●

Note) Use the -XC91 in a place where the distance from the welding portion is far and the spatter scattering is minimized.

How to Order

CDQ2 **Standard model no.** — **XC89**

Spatter-resistant rod material ↓

XC88	Stainless steel 304
XC89	S45C
XC91	S45C

(Standard)

Specifications

Bore size	φ32, φ40, φ50, φ63, φ80, φ100
Mounting brackets	Excludes the compact foot bracket
Type	Pneumatic
Mounting bolt for the through-hole type	Not included
Dimensions	See below.
Additional specifications	Same as standard type

(Long stroke)

Specifications

Mounting brackets	Excludes the compact foot bracket
Type	Pneumatic
Cushion	Rubber bumper
Dimensions	See below.
Additional specifications	Same as standard type

(Anti-lateral load)

Specifications

Mounting brackets	Excludes the compact foot bracket
Dimensions	See below.
Additional specifications	Same as standard type

Dimensions (Other dimensions are the same as the standard type.)

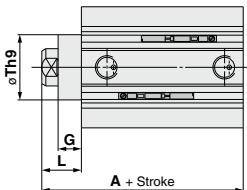

Bore size (mm)	XC88, 89						XC91				(mm)
	A			G	L	Th9	A	G	L	Th9	
	Standard	Long stroke	Anti-lateral load								
32	50	67.5	60	10	17	23 ⁰ _{-0.0102}	45	5	12	23 ⁰ _{-0.0102}	
40	56.5	77	66.5	10	17	28 ⁰ _{-0.0102}	51.5	5	12	28 ⁰ _{-0.0102}	
50	58.5	78.5	68.5	10	18	35 ⁰ _{-0.0102}	53.5	5	13	35 ⁰ _{-0.0102}	
63	64	80	74	10	18	35 ⁰ _{-0.0102}	59	5	13	35 ⁰ _{-0.0102}	
80	73.5	91	83.5	10	20	43 ⁰ _{-0.0102}	68.5	5	15	43 ⁰ _{-0.0102}	
100	85	102.5	95	10	22	59 ⁰ _{-0.0174}	80	5	17	59 ⁰ _{-0.0174}	

Made to Order Common Specifications:

-XC88: Spatter Resistant Coil Scraper, Lube-retainer, Grease for Welding (Piston rod: Stainless steel 304)

-XC89: Spatter Resistant Coil Scraper, Lube-retainer, Grease for Welding (Piston rod: S45C)

-XC91: Spatter Resistant Coil Scraper, Grease for Welding (Piston rod: S45C)



MGP-XC88(W)/XC89W/XC91(W)

62 Spatter Resistant Coil Scraper, Lube-retainer, Grease for Welding (Piston rod: Stainless steel 304) **-XC88**

63 Spatter Resistant Coil Scraper, Lube-retainer, Grease for Welding (Piston rod: S45C) **-XC89**

Reduces spatter adhesion and improves durability by the use of the coil scraper, Lube-retainer and grease for welding.

64 Spatter Resistant Coil Scraper, Grease for Welding (Piston rod: S45C) **-XC91**

With coil scraper and grease for welding

Applicable Series

Series	Description	Model	Action	XC88(W)	XC89	XC91(W)	Note	Vol. no. (for std model)
MGP	Compact guide cylinder	MGPM-Z	Double acting	●	—*	●	ø32 to ø100 only	Web Catalog
		MGPL-Z		—	—	●		
		MGPA-Z		—	—	●		

Made to Order

Part no.	Piston rod/ Guide rod material (Hard chrome plating)		Coil scraper		Lube-retainer		Grease for welding
	S45C	Stainless steel 304	Rod side	Head side	Rod side	Head side	
-XC88	—	●	●	—	●	—	●
-XC91	●	—	●	—	●	—	●
-XC88W	—	●	●	●	●	●	●
-XC89W	●	—	●	●	●	●	●
-XC91W	●	—	●	●	●	—	●

* There is no "-XC89" part number suffix as the specifications are the same as those of the "-XC91."

Specifications

Bore size	XC88, XC91	ø32, ø40, ø50, ø63, ø80, ø100
Max. operating pressure	XC88W, XC89W, XC91W	0.12 MPa 0.14 MPa
Dimensions	See below.	
Additional specifications	Same as standard type	

How to Order

Standard model no. — XC88W

Spatter-resistant rod material

Symbol	Scraper mounting position	Rod material
XC88	Single side scraper	Stainless steel 304
XC91		S45C
XC88W	Both sides scraper	Stainless steel 304
XC89W		S45C
XC91W		S45C

Single side scraper

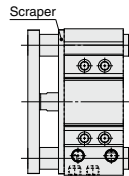

Both sides scraper

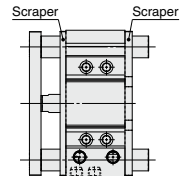

Dimensions (Other dimensions are the same as the standard type.)

Single side scraper (-XC88, -XC91)

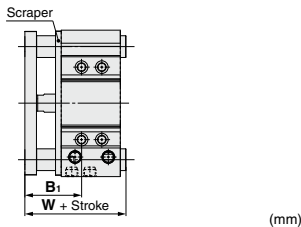

Bore size (mm)	XC88		XC91		XC35	
	B ₁	W ^{Note 1)}	B ₁	W ^{Note 1)}	B ₁	W ^{Note 1)}
32	53	85	53	85	53	85
40	54	85	54	85	54	85
50	62	98.5	62	98.5	62	98.5
63	62	98.5	62	98.5	62	98.5
80	78	114.5	78	114.5	78	114.5
100	71	136.5	71	136.5	71	136.5

* At 0 stroke

Note 1) W dimensions are for 50 stroke or less.

Both sides scraper (-XC88W, -XC89W, -XC91W)

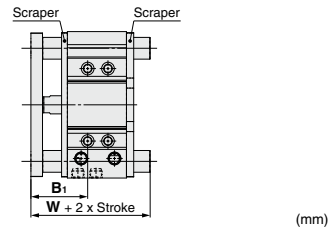

Bore size (mm)	XC88W XC89W		XC91W		XC35W	
	B ₁	W	B ₁	W	B ₁	W
32	53	82.5	53	82.5	53	82.5
40	54	89.5	54	89	54	89
50	62	95	62	95	62	95
63	62	100	62	100	62	100
80	78	120.5	78	120.5	78	120.5
100	71	143	71	143	71	143

* At 0 stroke

Made to Order Common Specifications:

-XC88: Spatter Resistant Coil Scraper, Lube-retainer, Grease for Welding (Piston rod: Stainless steel 304)

-XC89: Spatter Resistant Coil Scraper, Lube-retainer, Grease for Welding (Piston rod: S45C)

-XC91: Spatter Resistant Coil Scraper, Grease for Welding (Piston rod: S45C)



MK2T-XC89/XC91

63 Spatter Resistant Coil Scraper, Lube-retainer, Grease for Welding (Piston rod: S45C) -XC89

Reduces spatter adhesion and improves durability by the use of the coil scraper, Lube-retainer and grease for welding.

64 Spatter Resistant Coil Scraper, Grease for Welding (Piston rod: S45C) -XC91

With coil scraper and grease for welding

Applicable Series

Series	Description	Model	Action	XC89	XC91	Vol. no. (for std model)
MK2T	Rotary clamp cylinder	MK2T	Double acting	●	●	Web Catalog

How to Order

Standard model no.	—	XC89
Spatter-resistant rod material		
XC89	S45C	
XC91	S45C	

Made to Order

Part no.	Piston rod material (Hard chrome plated)	Coil scraper	Lube-retainer	Grease for welding
	S45C			
-XC89	●	●	●	●
-XC91	●	●	—	●

Note) Use the -XC91 in a place where the distance from the welding portion is far and the spatter scattering is minimized.

Specifications

Bore size	ø32, ø40, ø50, ø63
Dimensions	See below.
Additional specifications	Same as standard type

Dimensions (Other dimensions are the same as the standard type.)

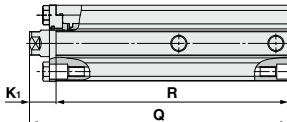

Clamp stroke: 10 mm (mm)

Bore size	XC89			XC91		
	Q	R	K ₁	Q	R	K ₁
32	156	140	16	148	140	8
40	160.5	144	16.5	151.5	144	7.5
50	—	—	—	—	—	—
63	—	—	—	—	—	—

Clamp stroke: 20 mm (mm)

Bore size	XC89			XC91		
	Q	R	K ₁	Q	R	K ₁
32	176	160	16	168	160	8
40	180.5	164	16.5	171.5	164	7.5
50	202.5	179	23.5	191	179	12
63	205	182	23	192	182	10

Clamp stroke: 50 mm (mm)

Bore size	XC89			XC91		
	Q	R	K ₁	Q	R	K ₁
32	—	—	—	—	—	—
40	—	—	—	—	—	—
50	266	242.5	23.5	254.5	242.5	12
63	269	246	23	256	246	10

Made to Order Common Specifications:

-XC88: Spatter Resistant Coil Scraper, Lube-retainer, Grease for Welding (Piston rod: Stainless steel 304)

-XC89: Spatter Resistant Coil Scraper, Lube-retainer, Grease for Welding (Piston rod: S45C)

-XC91: Spatter Resistant Coil Scraper, Grease for Welding (Piston rod: S45C)



CKG1-XC88/XC89/XC91

62 Spatter Resistant Coil Scraper, Lube-retainer, Grease for Welding (Piston rod: Stainless steel 304) **-XC88**

63 Spatter Resistant Coil Scraper, Lube-retainer, Grease for Welding (Piston rod: S45C) **-XC89**

Reduces spatter adhesion and improves durability by the use of the coil scraper, Lube-retainer and grease for welding.

64 Spatter Resistant Coil Scraper, Grease for Welding (Piston rod: S45C) **-XC91**

With coil scraper and grease for welding

■ **CKG1 series** **Magnetic Field Resistant Auto Switch Rod Mounting Type**

■ **CKG1 series** **General Purpose Auto Switch Band Mounting/Rod Mounting**

Applicable Series

Series	Description	Model	Action	XC88	XC89	XC91	Vol. no. (for std model)
CKG1	Clamp cylinder	CKG1-Z1	Double acting, Single rod	●	●	●	Web Catalog
		CKG1-Z	Double acting, Single rod	●	●	●	

How to Order

Standard model no. — **XC89**

Spatter-resistant rod material ↓

XC88	Stainless steel 304
XC89	S45C
XC91	S45C

Cushion ↓

NIII	With air cushion on the unclamped side (head end) (Standard)
W	With air cushion on both ends

Note) The dimensions of the product with the air cushion on both ends are the same as those of the product with the air cushion on the unclamped side (head end).

Specifications/CKG1-Z, CKG1-Z1 common

Bore size	ø40, ø50, ø63
End bracket	I, IA, Y, YA
Option	Mounting brackets "B," "D," "L," and "K" are not available.
Dimensions	See below.
Additional specifications	Same as standard type

Dimensions/CKG1-Z, CKG1-Z1 common (Other dimensions are the same as the standard type.)

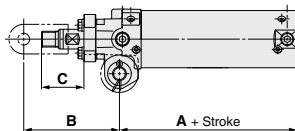

Bore size (mm)	XC88, 89			XC91		
	A	B	C	A	B	C
40	78	97	43	78	97	52
50	78	97	43	78	97	52
63	78	97	43	78	97	52

* At 0 stroke

Made to Order Common Specifications:

-XC88: Spatter Resistant Coil Scraper, Lube-retainer, Grease for Welding (Piston rod: Stainless steel 304)

-XC89: Spatter Resistant Coil Scraper, Lube-retainer, Grease for Welding (Piston rod: S45C)

-XC91: Spatter Resistant Coil Scraper, Grease for Welding (Piston rod: S45C)



CKGA-XC88/XC89/XC91

62 Spatter Resistant Coil Scraper, Lube-retainer, Grease for Welding (Piston rod: Stainless steel 304) **-XC88**

63 Spatter Resistant Coil Scraper, Lube-retainer, Grease for Welding (Piston rod: S45C) **-XC89**

Reduces spatter adhesion and improves durability by the use of the coil scraper, Lube-retainer and grease for welding.

64 Spatter Resistant Coil Scraper, Grease for Welding (Piston rod: S45C) **-XC91**

With coil scraper and grease for welding

CKGA series Rod Mounting

Applicable Series

Series	Description	Model	Action	XC88	XC89	XC91	Vol. no. (for std model)
CKG1	Clamp cylinder	CKGA	Double acting, Single rod	●	●	●	Web Catalog

How to Order

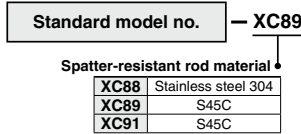

Made to Order

Part no.	Piston rod material (Hard chrome plated)		Coil scraper	Lube-retainer	Grease for welding
	S45C	Stainless steel 304			
-XC88	—	●	●	●	●
-XC89	●	—	●	●	●
-XC91	●	—	●	—	●

Note) Use the -XC91 in a place where the distance from the welding portion is far and the spatter scattering is minimized.

Specifications

Bore size	ø80, ø100
Dimensions	Same as standard type
Additional specifications	Same as standard type

Made to Order Common Specifications:

-XC88: Spatter Resistant Coil Scraper, Lube-retainer, Grease for Welding (Piston rod: Stainless steel 304)

-XC89: Spatter Resistant Coil Scraper, Lube-retainer, Grease for Welding (Piston rod: S45C)

-XC91: Spatter Resistant Coil Scraper, Grease for Welding (Piston rod: S45C)



CKGA-XC88/XC89/XC91

62 Spatter Resistant Coil Scraper, Lube-retainer, Grease for Welding (Piston rod: Stainless steel 304) **-XC88**

63 Spatter Resistant Coil Scraper, Lube-retainer, Grease for Welding (Piston rod: S45C) **-XC89**

Reduces spatter adhesion and improves durability by the use of the coil scraper, Lube-retainer and grease for welding.

64 Spatter Resistant Coil Scraper, Grease for Welding (Piston rod: S45C) **-XC91**

With coil scraper and grease for welding

Bore Size

ø80 to ø100

CKGA100^{-XC88/XC89}_{-XC91} With auto switch (D-P4DWS□).

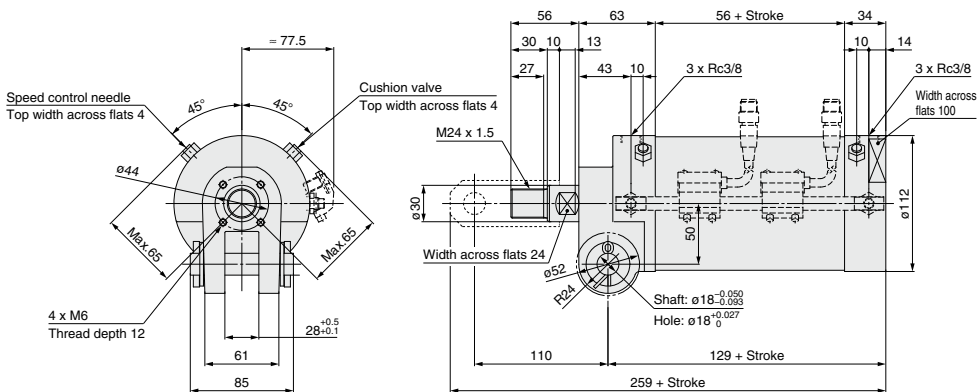

CKGA80^{-XC88/XC89}_{-XC91} With auto switch (D-P4DWS□).

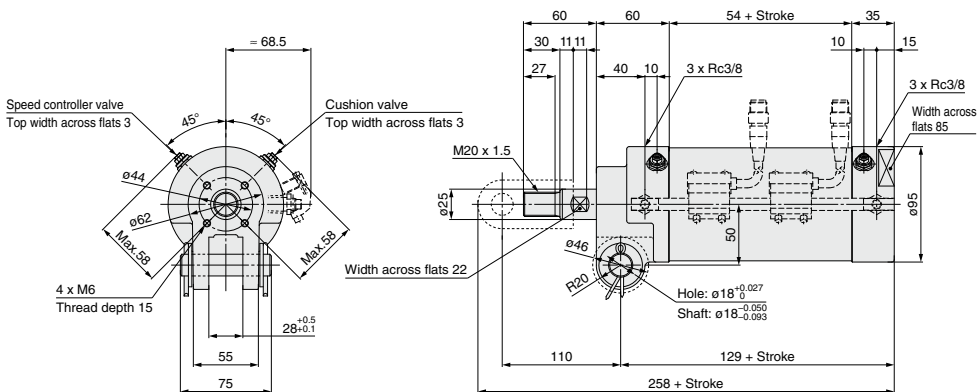

The specifications of the end bracket (double knuckle joint with pins) are the same as those of the standard model.

Comparison of the Dimensions of Each Series

The -XC88/XC89/XC91 and standard product have the same dimensions.



Made to Order Common Specifications: -XC92: Dust Resistant Actuator



65 Dust Resistant Actuator

Symbol
-XC92

Applicable for environments with flying micro-powder (20 to 30 μm) such as ceramic powder, toner powder, paper powder, and metallic powder (except weld spatter). 4 times stronger than the standard model

Applicable series

Series	Description/Type	Model	Action	Remark (s)	Vol. No. (for std model)
CM2	Air Cylinder	CM2	Double acting, Single rod	Compatible with cylinders with rubber bumper	Web Catalog
CQS	Compact Cylinder	CQS	Double acting, Single rod		
CQ2	Compact Cylinder	CQ2-Z	Double acting, Single rod	Applicable to ø32 to ø100.	
MGP	Compact Guide Cylinder	MGP	Double acting, Single rod		

How to Order

C(D)M2 [Mounting bracket] [Bore size] - [Stroke] - [Auto switch] [Suffix] - **XC92**
 * Auto switch is applicable for CDM2 only. Dust resistant actuator

Bore size (mm)	Standard stroke	Minimum operating pressure
20	25, 50, 75, 100, 125, 150, 200, 250, 300	0.1 MPa
25		
32		
40		

C(D)QS [Mounting bracket] [Bore size] - [Stroke] D [Body option] - [Auto switch] [Suffix] - **XC92**
 * Auto switch is applicable for CDQS only.
 * Body option with rear slip fit is not available. Dust resistant actuator

Bore size (mm)	Standard stroke	Minimum operating pressure
12, 16	5, 10, 15, 20, 25, 30	0.14 MPa
20, 25	5, 10, 15, 20, 25, 30, 35, 40, 45, 50	0.1 MPa

C(D)Q2 [Mounting bracket] [Bore size] - [Stroke] D [Body option] Z - [Auto switch] [Suffix] - **XC92**
 * Auto switch is applicable for CDQ2 only.
 * Body option with rear slip fit is not available. Dust resistant actuator

Bore size (mm)	Standard stroke	Minimum operating pressure
32, 40	5, 10, 15, 20, 25, 30, 35, 40, 45, 50, 75, 100	0.1 MPa
50 to 100	10, 15, 20, 25, 30, 35, 40, 45, 50, 75, 100	0.1 MPa

MGPM [Bore size] - [Stroke] - [Auto switch] [Suffix] - **XC92**
 Dust resistant actuator

Bore size (mm)	Standard stroke
12, 16	10, 20, 30, 40, 50, 75, 100
20, 25	20, 30, 40, 50, 75, 100, 125, 150, 175, 200
32 to 100	25, 50, 75, 100, 125, 150, 175, 200

Symbol	Type	Drive unit	Guide unit	
			Rod side	Head end
Nil	With lube-retainers on one side	○	○	—
W	With lube-retainers on both sides	○	○	○

XC92	Bore size	Minimum operating pressure
	ø12, ø16	0.2 MPa
ø20 to ø100	0.15 MPa	

XC92W	Bore size	Minimum operating pressure
	ø12, ø16	0.25 MPa
ø20 to ø100	0.2 MPa	

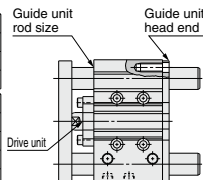

Specifications other than minimum operating pressure are the same as standard model.

Made to Order Common Specifications: -XC92: Dust Resistant Actuator



65 Dust Resistant Actuator

Symbol
-XC92

Dimensions (Other dimensions are the same as the standard type.)

CM2 series: The same as the standard type

CQS series

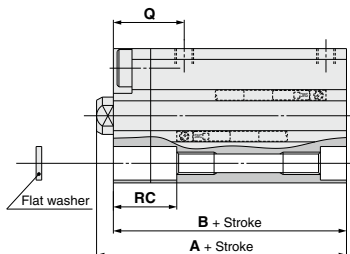
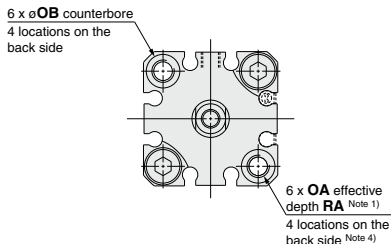

Note 1) For the standard type $\phi 12$ and $\phi 16$ with 5 strokes, $\phi 20$ with 15 strokes or less, and $\phi 25$ with 5 or 10 strokes, and for models with an auto switch and built-in magnet of $\phi 20$ with 5 strokes, the through-hole is threaded over the entire length.

Note 2) Be sure to use the attached flat washer for mounting cylinder with through-holes.

Note 3) For models with a rubber bumper, the stroke tolerance does not include bumper deflection.

Note 4) 2 locations on the back side for the standard-type $\phi 20$ with 15 strokes or less and $\phi 25$ with 10 strokes, and for models with an auto switch and built-in magnet of $\phi 20$ with 5 strokes.

Bore size (mm)	A		B		Q	OA	OB	RA	RC
	Without auto switch	With auto switch	Without auto switch	With auto switch					
12	30.5	35.5	27	32	17.5	M4 x 0.7	6.5	7	14
16	30.5	35.5	27	32	17.5	M4 x 0.7	6.5	7	14
20	34	44	29.5	39.5	19	M6 x 1.0	9	10	17
25	37.5	47.5	32.5	42.5	21	M6 x 1.0	9	10	17

CQ2 series

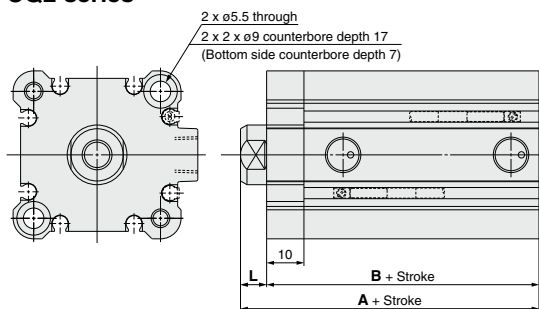

$\phi 32$

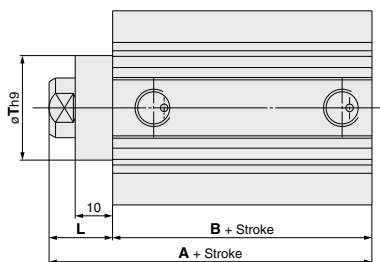

$\phi 40$ to $\phi 100$

Bore size (mm)	A		B		L	T
	Without auto switch	With auto switch	Without auto switch	With auto switch		
32	40 (50)	50	33 (43)	43	7	—
40	46.5 (56.5)	56.5	29.5 (39.5)	39.5	17	28
50	48.5 (58.5)	58.5	30.5 (40.5)	40.5	18	35
63	54 (64)	64	36 (46)	46	18	35
80	63.5 (73.5)	73.5	43.5 (53.5)	53.5	20	43
100	75 (85)	85	53 (63)	63	22	59

Note 1) For cylinders with rubber bumper, stroke tolerance does not include the amount of bumper change.

Note 2) Dimensions inside () are for 75, 100st.

Made to Order Common Specifications: -XC92: Dust Resistant Actuator



65 Dust Resistant Actuator

Symbol
-XC92

Dimensions (Other dimensions are the same as the standard type.)

MGP series

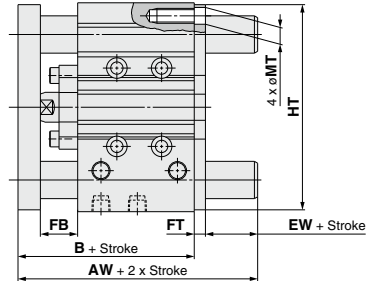
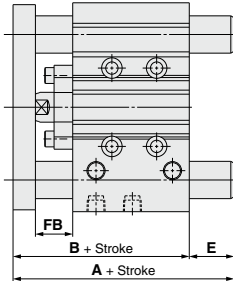

With Lube-retainers on one side (mm)

Bore size (mm)	A		B	E		FB
	50 st or less	Over 50 st and 200 st or less*		50 st or less	Over 50 st and 200 st or less*	
12	52	70.5	52	0	18.5	15
16	56	74.5	56	0	18.5	15
20	63	94.5	63	0	31.5	16
25	63.5	95	63.5	0	31.5	16
32	97	112	69.5	27.5	42.5	20
40	97	112	76	21	36	20
50	106.5	128	82	24.5	46	22
63	106.5	128	87	19.5	41	22
80	125	152	106.5	18.5	45.5	28
100	147	172	126	21	46	35

* The standard stroke for ø12 and ø16 is 100 st.

With Lube-retainers on both sides (mm)

Bore size (mm)	AW	B	EW	FB	FT	MT	HT
12	63	52	6	15	5	5	57
16	67	56	6	15	5	6	64
20	74	63	6	16	5	6	80
25	74.5	63.5	6	16	5	7	92
32	82.5	69.5	7	20	6	8.5	110
40	89	76	7	20	6	8.5	118
50	95	82	7	22	6	11	146
63	100	87	7	22	6	11	160
80	120.5	106.5	8	28	6	14	200
100	143	126	8	35	9	16	238

Made to Order Common Specifications: -XC93□: With Greater Water Resistance + Stable Lubrication Function



66 With Greater Water Resistance + Stable Lubrication Function

Symbol
-XC93

- 5 times stronger against water (liquids) than the standard model
- Equipped with the greater water resistant scraper (Fluororubber). The Lube-retainer creates grease coating around the piston rod, which improves lubrication.
- Stainless steel can be selected for the piston rod and rod end nut.

Applicable Series

Series	Description	Model	Action	Note	Vol. no. (for std model)
RHC	High power cylinder	RHC	Double acting, Single rod	Applicable bore size: ø32, ø40 Rc port only	Web Catalog

How to Order

Standard model no.

-XC93 □

With greater water resistance + stable lubrication function ↓

↓ Piston rod,
Rod end nut material

NII	Standard (Carbon steel)
S	Stainless steel

Dimensions (Dimensions other than below are the same as standard type.)

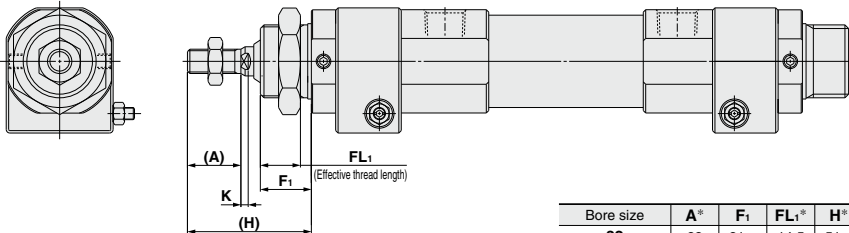

Bore size	A*	F ₁	FL ₁ *	H*	K
32	22	21	14.5	51	3
40	24	22.5	16.5	54.5	3

(mm)

*: Same as the standard model.

Made to Order Common Specifications -XC102: Lock Release Specification



67 Lock Release Specification

Symbol
-XC102

·Prevents lever damage when a transferred workpiece moves backward
(Prevents damage by releasing the locked lever when a pallet suddenly moves backward and collides with the lever)

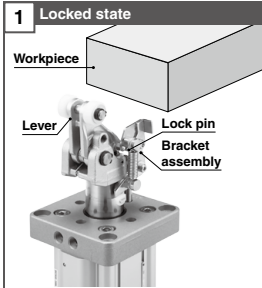

The lever is in the locked state when the lock pin is hooked on the bracket assembly.

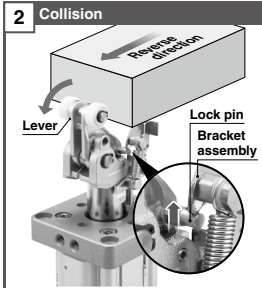

When a workpiece moves backward and collides with the lever, the lock pin unhooks from the bracket assembly as the lever is pushed backward.

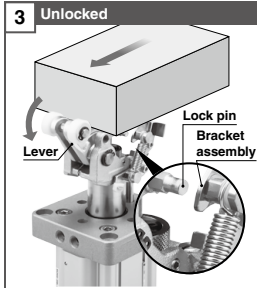

When the lock pin is unhooked from the bracket assembly, the lever becomes unlocked, which allows the workpiece to pass through.



Applicable Series

Series	Description	Model	Action	Note	Vol. no. (for std model)
RS2H	Heavy duty stopper cylinder	RS2H	Double acting		Web Catalog

Specifications

Lever	With lock mechanism
Shock absorber	Shock absorber with scraper (Option)
Specifications other than above	Same as the standard type

■ The main product specifications and dimensions are the same as those of the standard model. For further details on the shape and dimensions, refer to the CAD data.

How to Order

RS2H **50** **30** **D** **L** **D** **M9BW** **-XC102**



1 Bore size	2 Port thread type	3 Piping direction	4 Cylinder stroke	5 Action	6 Roller material
50 50 mm 63 63 mm 80 80 mm	Nil Nil Rc TN NPT TF G	Nil Flange side A Axial direction (tube)	30 30 mm (ø50, ø63) 40 40 mm (ø80)	D Double acting B Double acting spring type T Single acting/spring extend	L Resin M Carbon steel

7 Option*1

Nil	Without option
C	With cancel cap
S	With lever detection switch*2

*1 Options can be combined.
Indicate the option symbols in the order of "C" then "S."

*2 For details on the lever detection switch, refer to the standard model.

9 Shock absorber

Nil	Standard
Y	Shock absorber with scraper

10 Auto switch

Nil	Without auto switch (Built-in magnet)
-----	---------------------------------------

* The applicable auto switches are the same as those for the standard model.

* Auto switches are shipped together with the product but do not come assembled.

11 Number of auto switches (Number of auto switches mounted)

Nil	2
S	1

8 Positional relationship of the lever and port

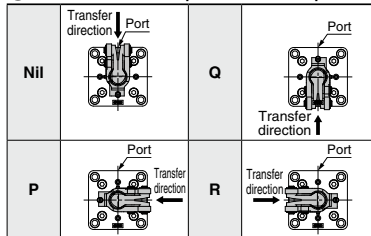

Replacement Parts/Shock Absorber

Bore size (mm)	Order no.	
	Standard	With scraper
50	RS2H-R50	RS2H-R50-X2666
63	RS2H-R63	RS2H-R63-X2666
80	RS2H-R80	RS2H-R80-X2666

* The shock absorber can be replaced individually.
Mounting of the built-in shock absorber with a scraper is interchangeable with the standard shock absorber (RS2H-R□).

Made to Order Common Specifications: -XC103: Cylinder for the Foot Type or the Rod Flange Type Mounting Bracket



68 Cylinder for the Foot Type or the Rod Flange Type Mounting Bracket

Symbol

-XC103

For cylinders with a foot type or a rod flange type mounting bracket (The rod end length is 5 mm longer than that of the standard model.)

Applicable Series

Series	Description	Model	Action	Note	Vol. no. (for std model)
JCQ	Compact cylinder	JCQ	Double acting, Single rod		Web Catalog

How to Order

JC(D)QA - XC103

↓ Cylinder for the foot type or the rod flange type mounting bracket

Specifications

Mounting type	Both ends tapped
Dimensions	See below.
Specifications other than above	Same as standard type

Dimensions (Dimensions other than below are the same as standard type.)

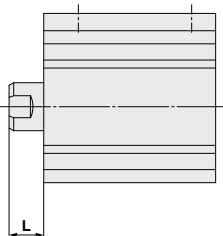

Bore size	L (mm)
32	10
40	11
50	13
63	13
80	14
100	15

Dimensions other than those above are the same as those of the standard model.

Made to Order Common Specifications: -XC104: Built-in Cylinder with Lock (MWB)



Symbol

-XC104

69 Built-in Cylinder with Lock (MWB)

This type has a built-in cylinder with lock, which accommodates intermediate stops, emergency stops and drop prevention, etc.

Applicable Series

Series	Description	Model	Action	Note	Vol. no. (for std model)
MGG	Guide cylinder	MGG	Double acting		②-2 From P. 538

How to Order

MGG **Bearing type** **Mounting type** **Bore size** **Port thread type** - **Stroke** - **Auto switch** - **XC104**

Built-in cylinder with lock

Specifications

Applicable series	MGG			
Bore size (mm)	50	63	80	100
Basic cylinder	MDWBB	Bore size	Port thread type	- Stroke N - Auto switch
Minimum operating pressure <small>Note)</small>	0.2 MPa (Horizontal with no load)			
Piston speed	50 to 1000 mm/s	50 to 700 mm/s		
Stroke adjustment range (One side) [Built-in adjusting bolts (2 pcs.)]	0 to -15 mm			
Non-rotating accuracy ^{*2}	Slide bearing	±0.04°		±0.03°
	Ball bushing bearing	±0.03°		±0.02°
Shock absorber model	RB2015		RB2725	

*1 Specifications other than shown above are the same as the standard type.

*2 Non-rotating rod accuracy must be below the values shown in the table at the retraction of the cylinder (initial value), and without loads or the conditions excluding the deflection of the guide rods.

Note) When the piston is locked, the load mass is limited by the mounting orientation and the operating pressure.
For details about the lock specifications, etc., refer to the cylinders with lock/MWB series.

Made to Order Common Specifications: -XC104: Built-in Cylinder with Lock (MWB)



Dimensions

Basic type
ø50 to ø100

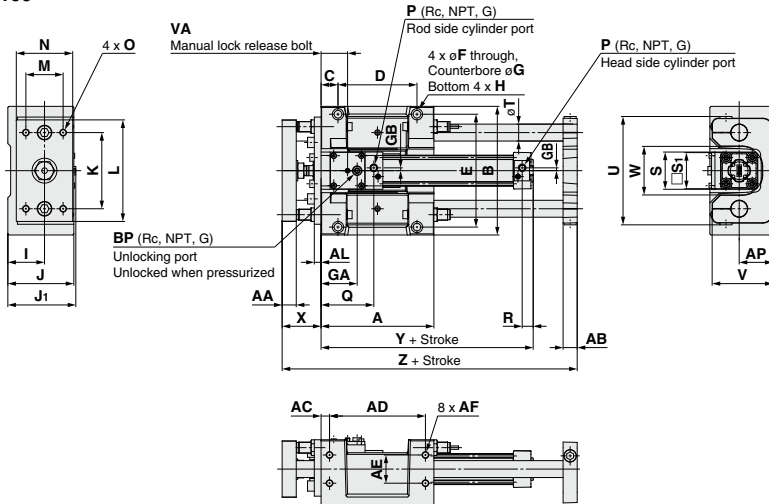

(mm)

Bore size (mm)	A	AA	AB	AC	AD	AE	AF	AL	AP	B	C	D	E	F	G	GA	GB	H	I
50	200	25	25	15	170	50	M12 x 1.75 depth 24	12	60	228	30	140	200	13.5	20 depth 14.5	64	5	M16 x 2 depth 28	65
63	230	25	27	15	200	55	M12 x 1.75 depth 24	12	70	262	30	170	234	13.5	20 depth 14.5	73	9	M16 x 2 depth 28	75
80	280	30	30	17.5	245	70	M14 x 2.0 depth 28	16	80	304	35	210	274	15	23 depth 17	92	11.5	M18 x 2.5 depth 32	85
100	280	32	30	17.5	245	70	M14 x 2.0 depth 28	16	80	304	35	210	274	15	23 depth 17	109	17	M18 x 2.5 depth 32	85

Bore size (mm)	J	J ₁	K	L	M	N	O	P	BP	Q	R	S	S ₁	T	U	V	VA	W	X	Y	Z
50	117	120.5	135	180	66	100	M12 x 1.75 depth 23	1/4	1/8	93.5	19.5	66	65	30	192	108	47	86	69	184	323
63	138	134.5	160	214	76	115	M12 x 1.75 depth 23	3/8	1/4	106.5	20.5	78	75	35	224	128	53	104	69	196	358
80	153	156.5	190	245	80	125	M14 x 2 depth 28	3/8	1/4	132	23	98	95	40	262	143	65	128	87	241	431
100	153	165.5	190	245	80	125	M14 x 2 depth 30	1/2	1/4	150	23	116	114	40	262	143	74	128	87	261	431

Made to Order Common Specifications: -XC104: Built-in Cylinder with Lock (MWB)



Dimensions

Front mounting flange type ø50 to ø100

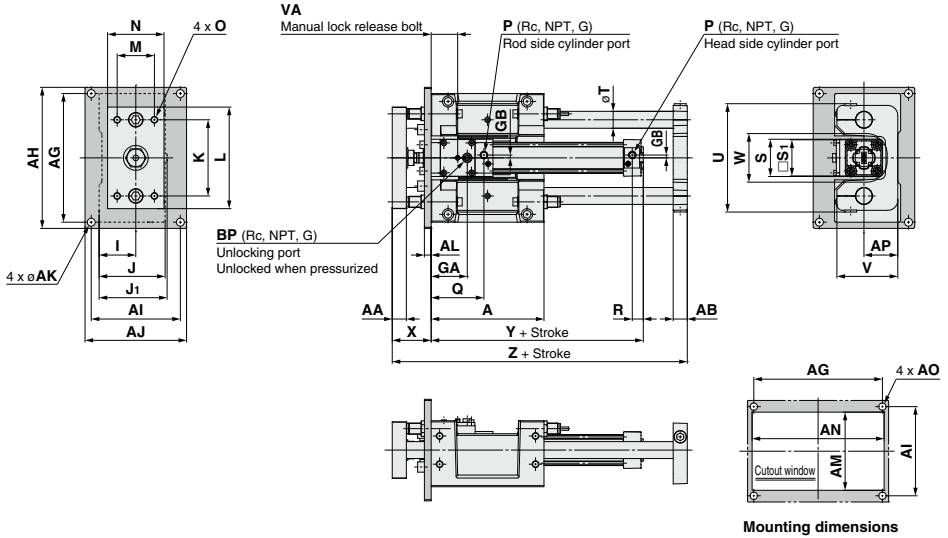

(mm)

Bore size (mm)	A	AA	AB	AG	AH	AI	AJ	AK	AL	AM	AN	AO	AP	B	GA	GB	I	J	J ₁
50	200	25	25	228	250	158	180	14	12	135	234	M12	60	228	64	5	65	117	120.5
63	230	25	27	262	284	178	200	14	12	155	268	M12	70	262	73	9	75	138	134.5
80	280	30	30	300	326	200	226	16	16	175	310	M14	80	304	92	11.5	85	153	156.5
100	280	32	30	300	326	200	226	16	16	175	310	M14	80	304	109	17	85	153	165.5

Bore size (mm)	K	L	M	N	O	P	BP	Q	R	S	S ₁	T	U	V	VA	W	X	Y	Z
50	135	180	66	100	M12 x 1.75 depth 23	1/4	1/8	93.5	19.5	66	65	30	192	108	47	86	69	184	323
63	160	214	76	115	M12 x 1.75 depth 23	3/8	1/4	106.5	20.5	78	75	35	224	128	53	104	69	196	358
80	190	245	80	125	M14 x 2 depth 28	3/8	1/4	132	23	98	95	40	262	143	65	128	87	241	431
100	190	245	80	125	M14 x 2 depth 30	1/2	1/4	150	23	116	114	40	262	143	74	128	87	261	431